

## Ultra-Low Power Operational Amplifier

### Features

- SC70 Packaging
- 400 kHz Gain-Bandwidth Product
- 650 kHz, -3dB Bandwidth
- 4.6  $\mu$ A Supply Current
- Rail-to-Rail Output
- Ground Sensing at Input (Common Mode to GND)
- Drives Large Capacitive Loads (1000 pF)
- Unity Gain Stable

### Applications

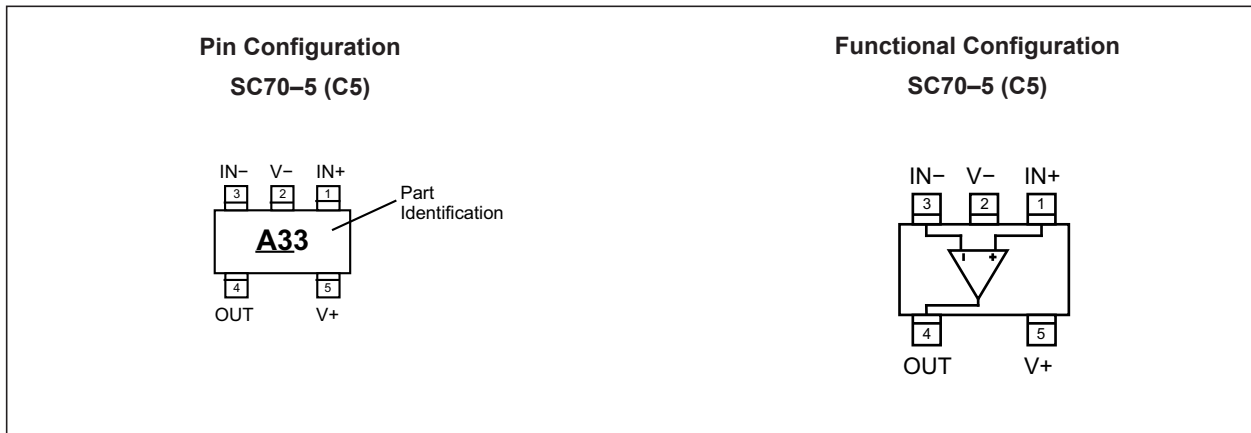
- Handheld Electronics
- Laptop Computers
- Tablets
- Mobile Phones
- Consumer Electronics

### Package Type

### General Description

The MIC861 is a rail-to-rail output, input common-mode to ground, operational amplifier in SC70 packaging. The MIC861 provides a 400 kHz gain-bandwidth product while consuming an incredibly low 4.6  $\mu$ A supply current.

The SC70 packaging achieves significant board space savings over devices packaged in SOT-23 or MSOP-8 packaging. The SC70 occupies approximately half the board area of a SOT-23 package.



# MIC861

---

## 1.0 ELECTRICAL CHARACTERISTICS

### Absolute Maximum Ratings †

Supply Voltage ( $V_{V+}$ to $V_{V-}$ ) .....	+6.0V
Differential Input Voltage ( $V_{IN+}$ to $V_{IN-}$ ) .....	+6.0V
Input Voltage ( $V_{IN+}$ , $V_{IN-}$ ) .....	$V_+$ +0.3V to $V_-$ -0.3V
Output Short-Circuit Current Duration .....	Indefinite
ESD Rating.....	(Note 1)

### Operating Ratings ‡

Supply Voltage ( $V_+$ to $V_-$ ) .....	+2.43V to +5.25V
---	------------------

† **Notice:** Stresses above those listed under “Absolute Maximum Ratings” may cause permanent damage to the device. This is a stress rating only and functional operation of the device at those or any other conditions above those indicated in the operational sections of this specification is not intended. Exposure to maximum rating conditions for extended periods may affect device reliability.

‡ **Notice:** The device is not guaranteed to function outside the operating ratings.

**Note 1:** Devices are ESD sensitive. Handling precautions are recommended. Human body model, 1.5 k $\Omega$  in series with 100 pF. Pin 4 is ESD sensitive.

## ELECTRICAL CHARACTERISTICS

**Electrical Characteristics:**  $V_+ = +2.7V$ ,  $V_- = 0V$   $V_{CM} = V_+/2$ ;  $R_L = 500\text{ k}\Omega$  to  $V_+/2$ ;  $T_A = 25^\circ\text{C}$ , unless otherwise noted. (Note 2).

Parameters	Symbol	Min.	Typ.	Max.	Units	Conditions
Input Offset Voltage	$V_{OS}$	-10	2	10	mV	$-40^\circ\text{C} \leq T_A \leq +85^\circ\text{C}$ (Note 1)
Input Offset Voltage Temperature Coefficient		—	15	—	$\mu\text{V}/^\circ\text{C}$	—
Input Bias Current	$I_B$	—	20	—	pA	—
Input Offset Current	$I_{OS}$	—	10	—	pA	—
Input Voltage Range	$V_{CM}$	—	1.8	—	V	CMRR >60 dB
Common-Mode Rejection Ratio	CMRR	45	77	—	dB	$0 < V_{CM} < 1.35V$ , $-40^\circ\text{C} \leq T_A \leq +85^\circ\text{C}$
Power Supply Rejection Ratio	PSRR	50	83	—	dB	Supply voltage change of 3V, $-40^\circ\text{C} \leq T_A \leq +85^\circ\text{C}$
Large-Signal Voltage Gain	$A_{VOL}$	60	74	—	dB	$R_L = 100\text{ k}\Omega$ , $V_{OUT} = 2V_{PP}$ , $-40^\circ\text{C} \leq T_A \leq +85^\circ\text{C}$
		73	83	—	dB	$R_L = 500\text{ k}\Omega$ , $V_{OUT} = 2V_{PP}$ , $-40^\circ\text{C} \leq T_A \leq +85^\circ\text{C}$
Maximum Output Voltage Swing	$V_{OUT}$	$V \pm 2\text{ mV}$	$V \pm 0.7\text{ mV}$	—	V	$R_L = 500\text{ k}\Omega$ , $-40^\circ\text{C} \leq T_A \leq +85^\circ$
		—	$V \pm 0.2\text{ mV}$	$V \pm 2\text{ mV}$		
Gain-Bandwidth Product	GBWP	—	350	—	kHz	$R_L = 200\text{ k}\Omega$ , $C_L = 2\text{ pF}$ , $V_{OUT} = 0$
-3 dB Bandwidth	$B_W$	—	500	—	kHz	$A_V = 1$ , $C_L = 2\text{ pF}$ , $R_L = 1\text{ M}\Omega$
Slew Rate	$S_R$	—	0.12	—	V/ $\mu\text{s}$	$A_V = 1$ , $C_L = 2\text{ pF}$ , $R_L = 1\text{ M}\Omega$
Short-Circuit Output Current	$I_{SC}$	—	6	—	mA	Source
	—	—	5	—	mA	Sink
Supply Current	$I_S$	—	4.2	9	$\mu\text{A}$	No load, $-40^\circ\text{C} \leq T_A \leq +85^\circ$

# MIC861

## ELECTRICAL CHARACTERISTICS (SINGLE SUPPLY)

Electrical Characteristics: $V_+ = +5V$ , $V_- = 0V$ , $V_{CM} = V_+/2$ ; $R_L = 500\text{ k}\Omega$ to $V_+/2$ ; $T_A = 25^\circ\text{C}$ , $T_A = T_J$ ; unless otherwise noted (Note 2).						
Parameters	Symbol	Min.	Typ.	Max.	Units	Conditions
Input Offset Voltage	$V_{OS}$	-10	2	10	mV	$-40^\circ\text{C} \leq T_A \leq +85^\circ\text{C}$ (Note 1)
Input Offset Voltage Temperature Coefficient		—	15	—	$\mu\text{V}/^\circ\text{C}$	—
Input Bias Current	$I_B$	—	20	—	pA	—
Input Offset Current	$I_{OS}$	—	10	—	pA	—
Input Voltage Range	$V_{CM}$	—	4.2	—	V	CMRR >60 dB
Common-Mode Rejection Ratio	CMRR	60	80	—	dB	$0 < V_{CM} < 3.5V$ , $-40^\circ\text{C} \leq T_A \leq +85^\circ\text{C}$
Power Supply Rejection Ratio	PSRR	45	85	—	dB	Supply voltage change of 1V, $-40^\circ\text{C} \leq T_A \leq +85^\circ\text{C}$
Large-Signal Voltage Gain	$A_{VOL}$	60	76	—	dB	$R_L = 100\text{ k}\Omega$ , $V_{OUT} = 4V_{PP}$ , $-40^\circ\text{C} \leq T_A \leq +85^\circ\text{C}$
		68	83	—	dB	$R_L = 500\text{ k}\Omega$ , $V_{OUT} = 4V_{PP}$ , $-40^\circ\text{C} \leq T_A \leq +85^\circ\text{C}$
Maximum Output Voltage Swing	$V_{OUT}$	$V$ $\pm 2\text{ mV}$	$V$ $\pm 0.7\text{ mV}$	—	V	$R_L = 500\text{ k}\Omega$ , $-40^\circ\text{C} \leq T_A \leq +85^\circ\text{C}$
		—	$V$ $\pm 0.7\text{ mV}$	$V$ $\pm 2\text{ mV}$	V	
Gain-Bandwidth Product	GBWP	—	400	—	kHz	$R_L = 200\text{ k}\Omega$ , $C_L = 2\text{ pF}$ , $V_{OUT} = 0$
-3 dB Bandwidth	$B_W$	—	650	—	kHz	$A_V = 1$ , $C_L = 2\text{ pF}$ , $R_L = 1\text{ M}\Omega$
Slew Rate	$S_R$	—	0.12	—	V/ $\mu\text{s}$	$A_V = 1$ , $C_L = 2\text{ pF}$ , $R_L = 1\text{ M}\Omega$
Short-Circuit Output Current	$I_{SC}$	10	24	—	mA	Source, $-40^\circ\text{C} \leq T_A \leq +85^\circ\text{C}$
				—	mA	Sink, $-40^\circ\text{C} \leq T_A \leq +85^\circ\text{C}$
Supply Current	$I_S$	—	4.6	9	$\mu\text{A}$	No load, $-40^\circ\text{C} \leq T_A \leq +85^\circ\text{C}$

**Note 1:** The offset voltage distribution is centered around 0V. The typical offset number shown is equal to the standard deviation of the voltage offset distribution.

**2:** Specification for packaged product only. Exceeding the maximum differential input voltage will damage the input stage and degrade performance (in particular, input bias will likely increase).

## TEMPERATURE SPECIFICATIONS (Note 1)

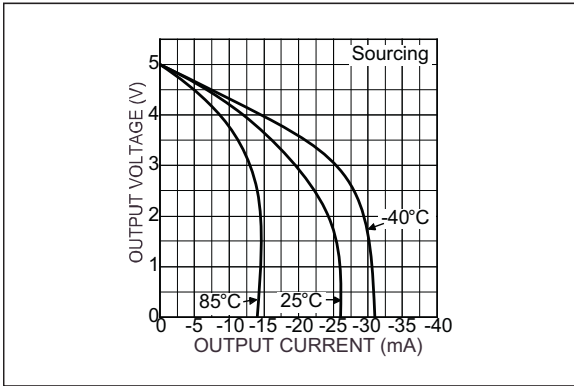
Parameters	Sym.	Min.	Typ.	Max.	Units	Conditions
<b>Temperature Ranges</b>						
Storage Temperature	$T_S$	—	—	150	°C	—
Ambient Temperature Range	$T_A$	-40	—	+85	°C	—
Lead Temperature	—	—	—	260	°C	Soldering, 5s
<b>Package Thermal Resistance</b>						
Thermal Resistance SC70	$\theta_{JA}$	—	450	—	°C/W	—

**Note 1:** The maximum allowable power dissipation is a function of ambient temperature, the maximum allowable junction temperature and the thermal resistance from junction to air (i.e.,  $T_A$ ,  $T_J$ ,  $\theta_{JA}$ ). Exceeding the maximum allowable power dissipation will cause the device operating junction temperature to exceed the maximum +85°C rating. Sustained junction temperatures above +85°C can impact the device reliability.

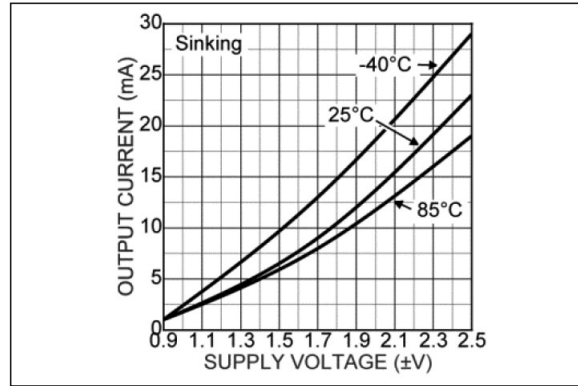
## 2.0 TYPICAL PERFORMANCE CURVES

**Note:** The graphs and tables provided following this note are a statistical summary based on a limited number of samples and are provided for informational purposes only. The performance characteristics listed herein are not tested or guaranteed. In some graphs or tables, the data presented may be outside the specified operating range (e.g., outside specified power supply range) and therefore outside the warranted range.

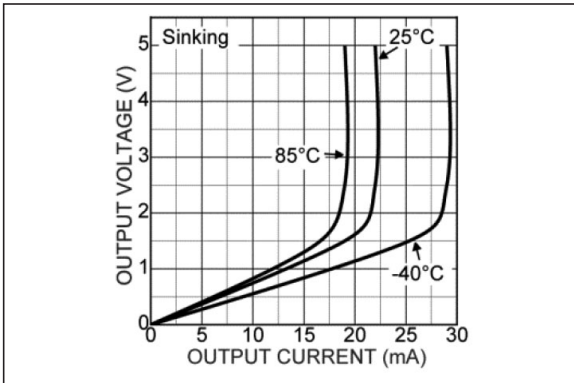
### DC Typical Characteristics:



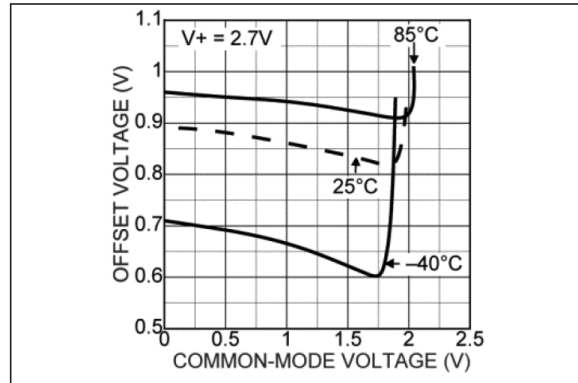
**FIGURE 2-1:** Output Voltage vs. Output Current.



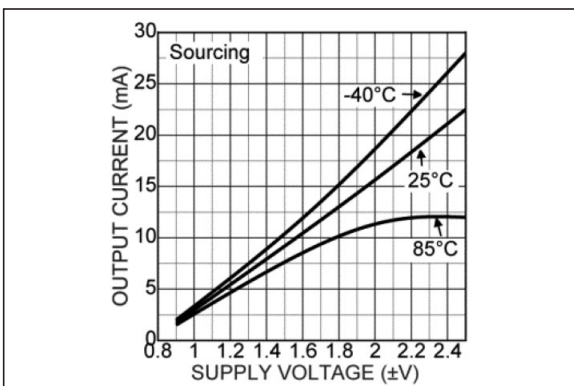
**FIGURE 2-4:** Short Circuit Current vs. Supply Voltage.



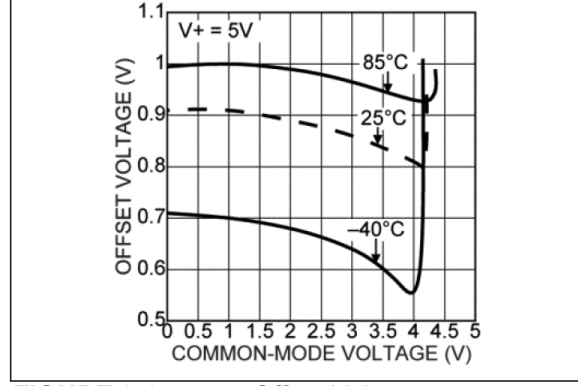
**FIGURE 2-2:** Output Voltage vs. Output Current.



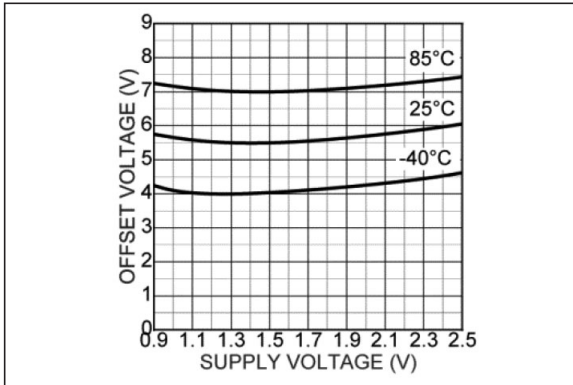
**FIGURE 2-5:** Offset Voltage vs. Common-Mode Voltage.



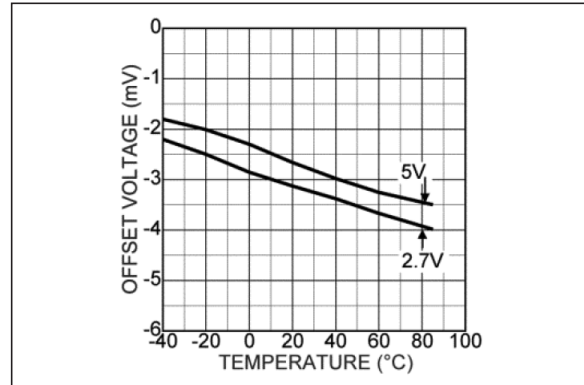
**FIGURE 2-3:** Short Circuit Current vs. Supply Voltage.



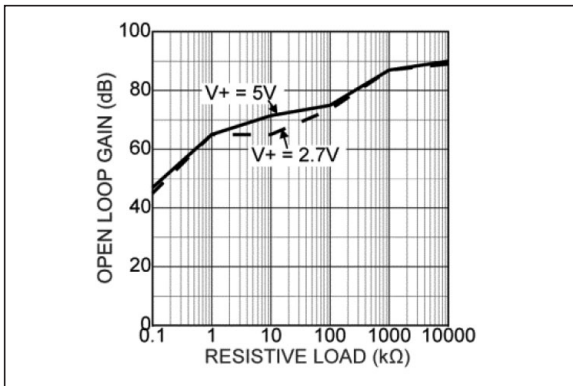
**FIGURE 2-6:** Offset Voltage vs. Common-Mode Voltage.



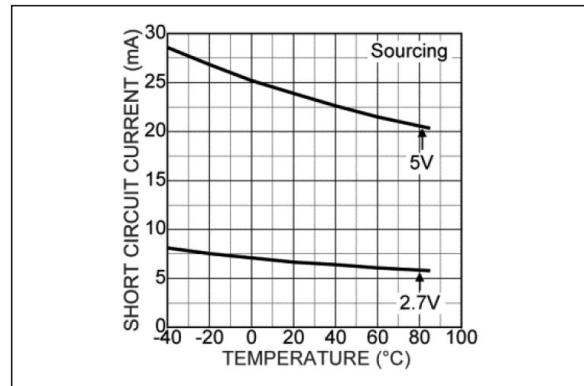
**FIGURE 2-7:** Offset Voltage vs. Supply Voltage.



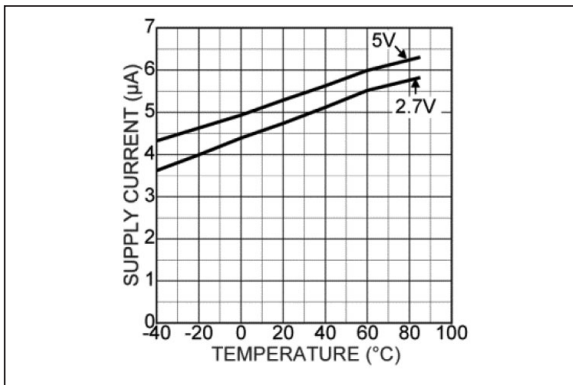
**FIGURE 2-10:** Offset Voltage vs. Temperature.



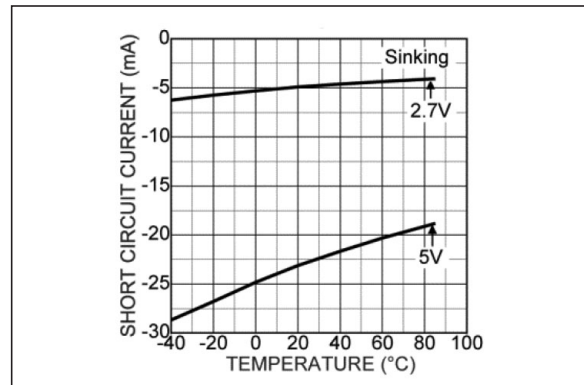
**FIGURE 2-8:** Open Loop Gain vs. Resistive Load.



**FIGURE 2-11:** Short Circuit Current vs. Temperature.



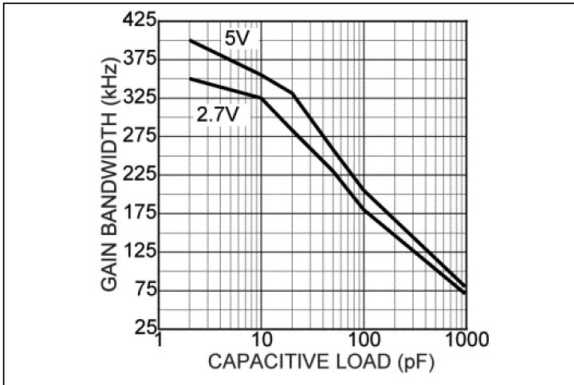
**FIGURE 2-9:** Supply Current vs. Temperature.



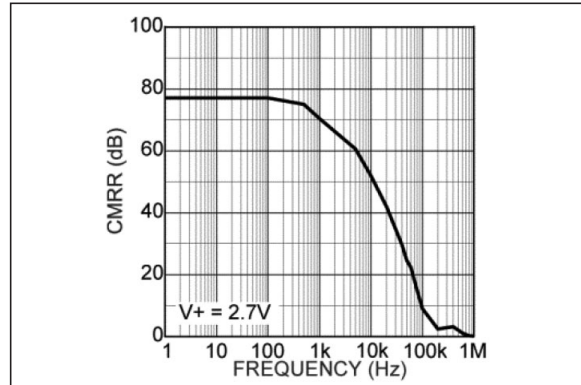
**FIGURE 2-12:** Short Circuit Current vs. Temperature.

# MIC861

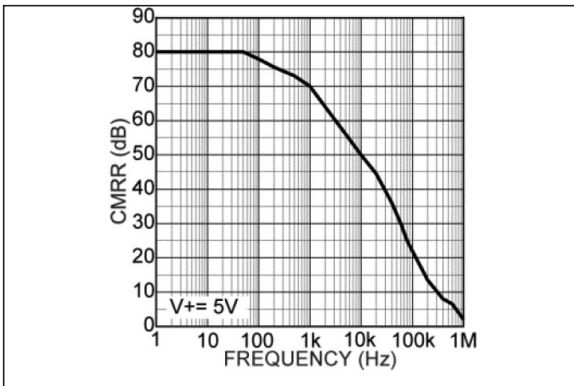
## AC Typical Characteristics:



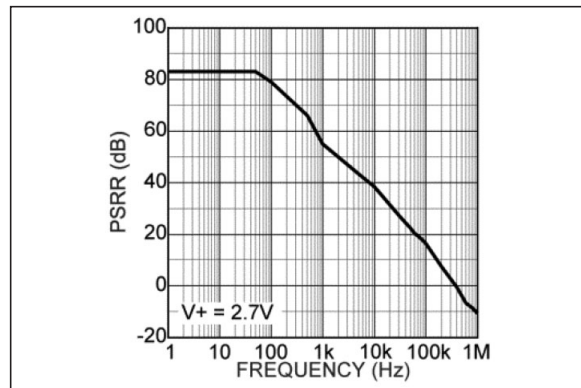
**FIGURE 2-13:** Gain Bandwidth vs. Capacitive Load.



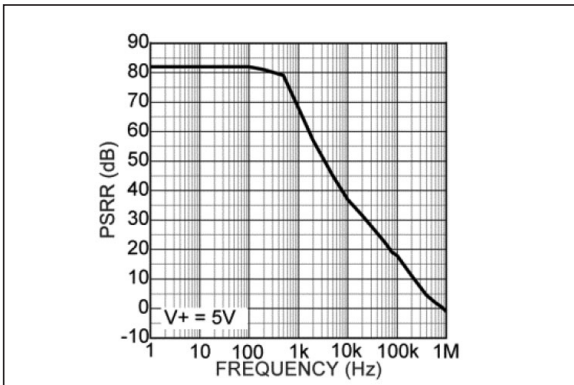
**FIGURE 2-16:** CMRR vs. Frequency.



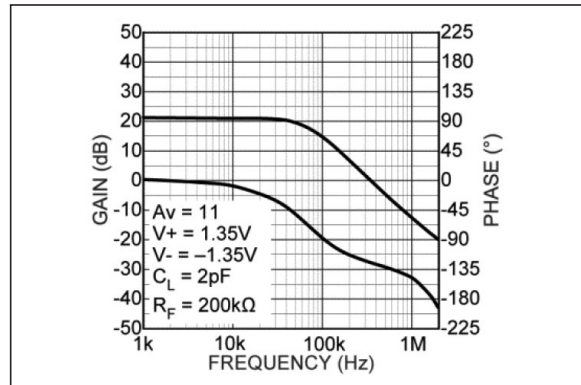
**FIGURE 2-14:** CMRR vs. Frequency.



**FIGURE 2-17:** PSRR vs. Frequency.

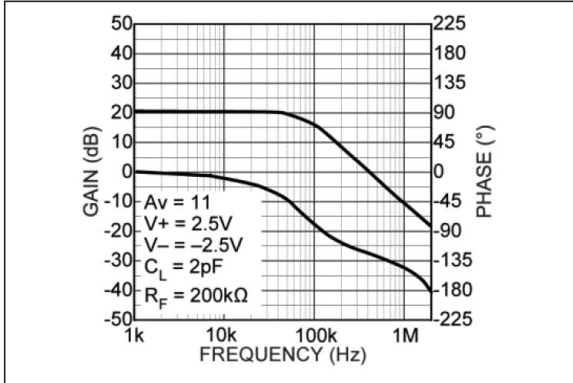


**FIGURE 2-15:** PSRR vs. Frequency.

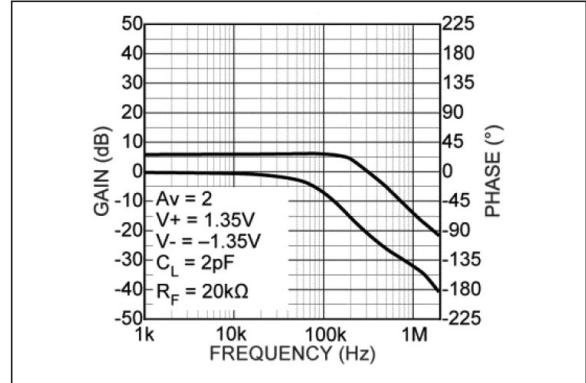


**FIGURE 2-18:** Gain Bandwidth and Phase Margin.

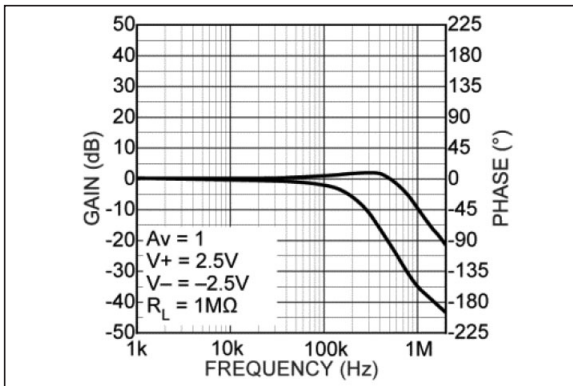




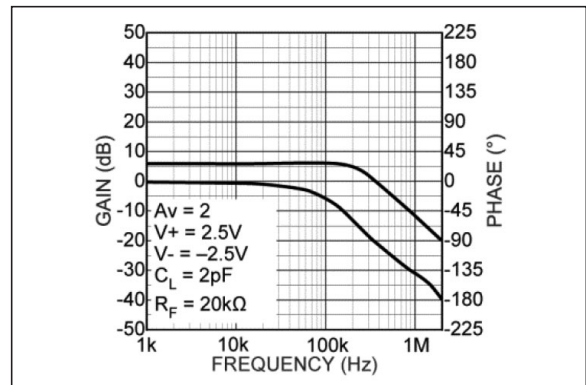
**FIGURE 2-19:** Gain Bandwidth and Phase Margin.



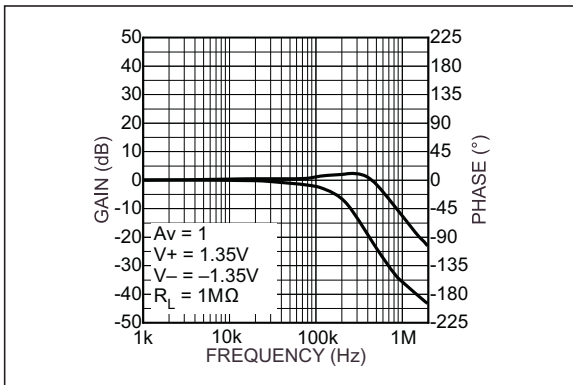
**FIGURE 2-22:** Gain Frequency Response.



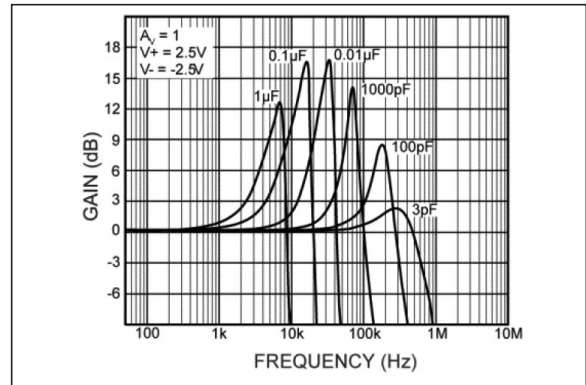
**FIGURE 2-20:** Unity Gain Frequency Response.



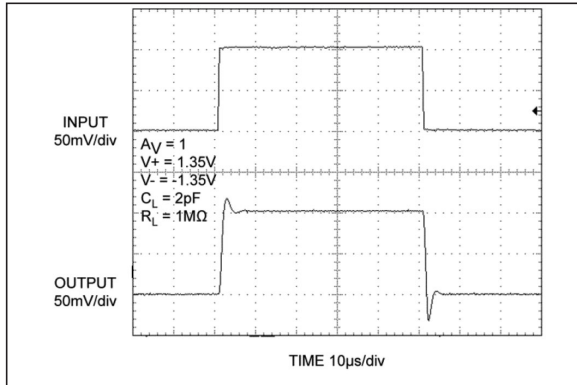
**FIGURE 2-23:** Gain Bandwidth and Phase Margin.



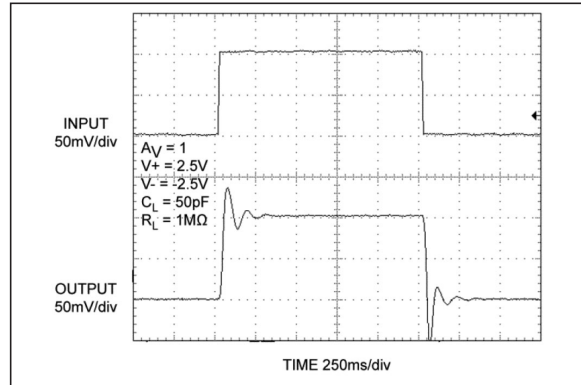
**FIGURE 2-21:** Unity Gain Frequency Response.



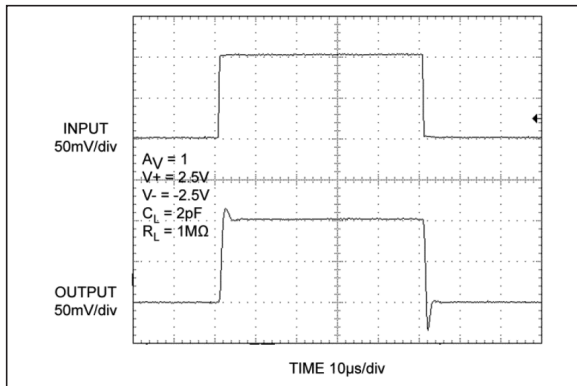
**FIGURE 2-24:** Closed-Loop Unity Gain Frequency Response.



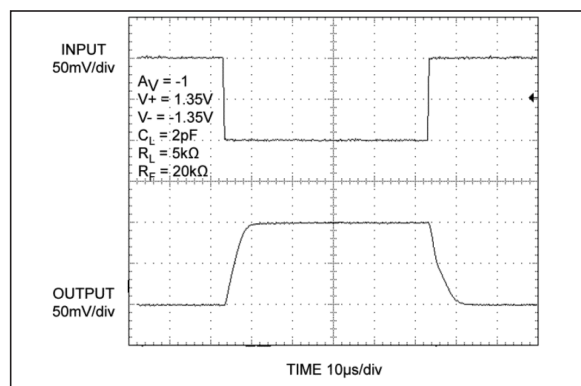
**FIGURE 2-25:** Small Signal Pulse Response (See Figure 3-3).



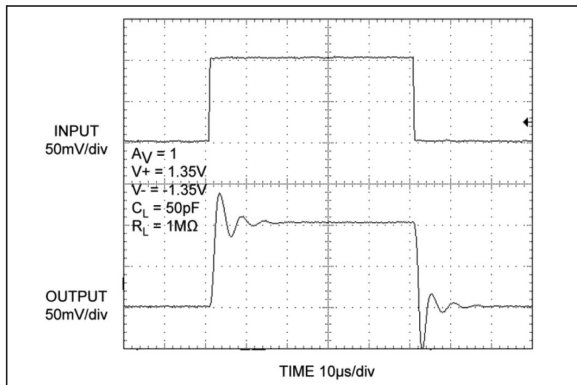
**FIGURE 2-28:** Small Signal Pulse Response (See Figure 3-3).



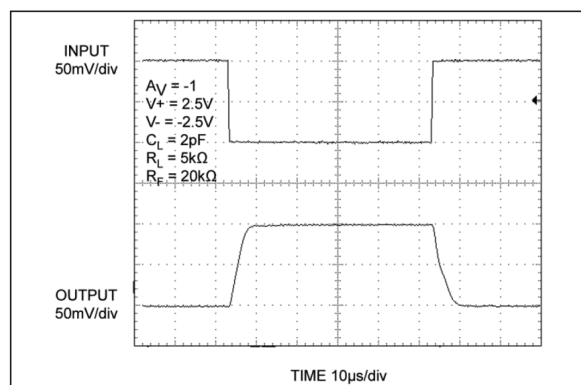
**FIGURE 2-26:** Small Signal Pulse Response (See Figure 3-3).



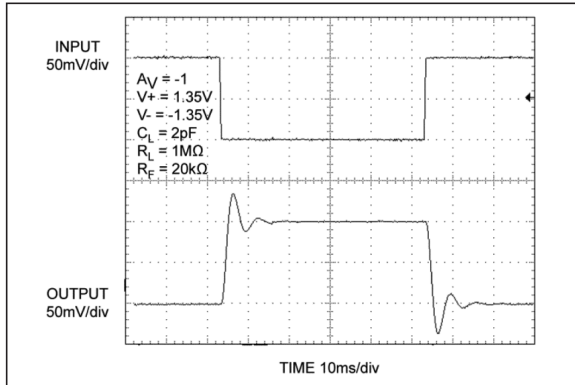
**FIGURE 2-29:** Small Signal Pulse Response (See Figure 3-4).



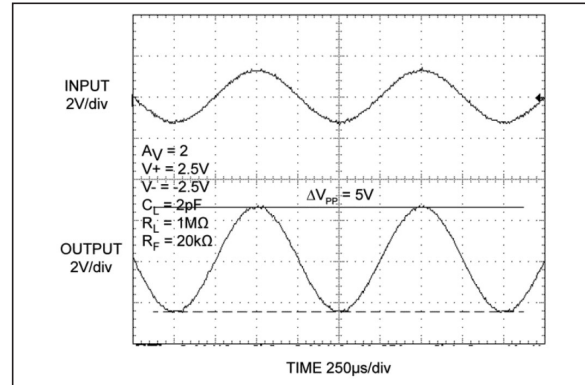
**FIGURE 2-27:** Small Signal Pulse Response (See Figure 3-3).



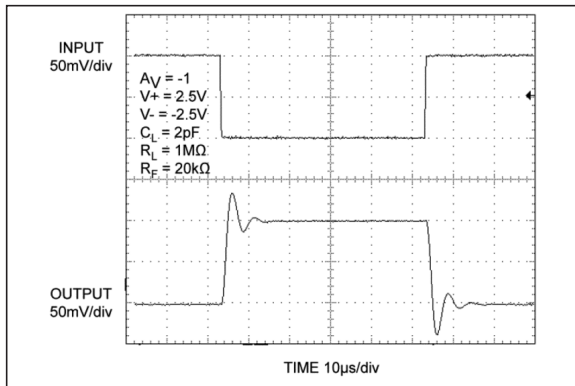
**FIGURE 2-30:** Small Signal Pulse Response (See Figure 3-4).



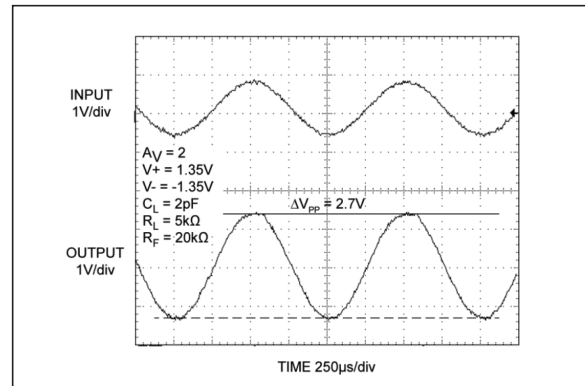
**FIGURE 2-31:** Small Signal Pulse Response (See Figure 3-4).



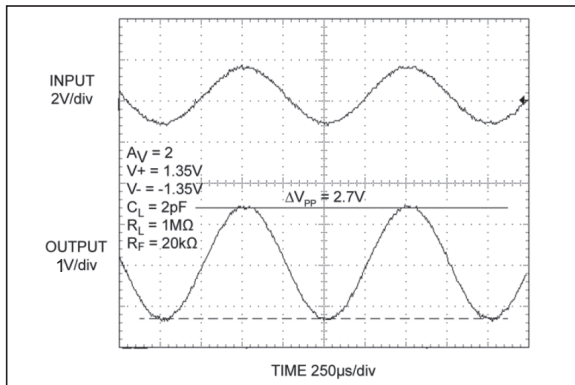
**FIGURE 2-34:** Rail to Rail Output Operation.



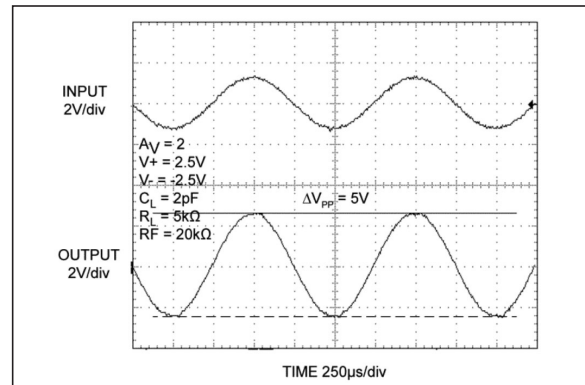
**FIGURE 2-32:** Small Signal Pulse Response (See Figure 3-4).



**FIGURE 2-35:** Rail to Rail Output Operation.

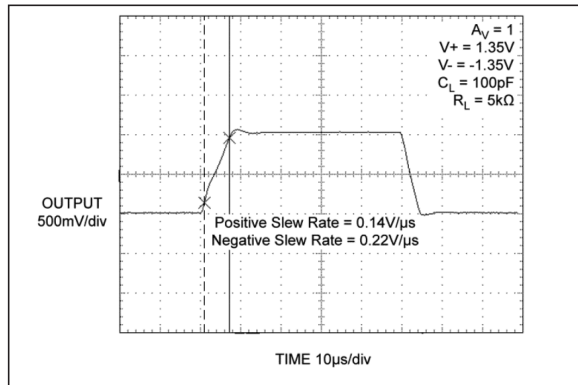


**FIGURE 2-33:** Rail to Rail Output Operation.

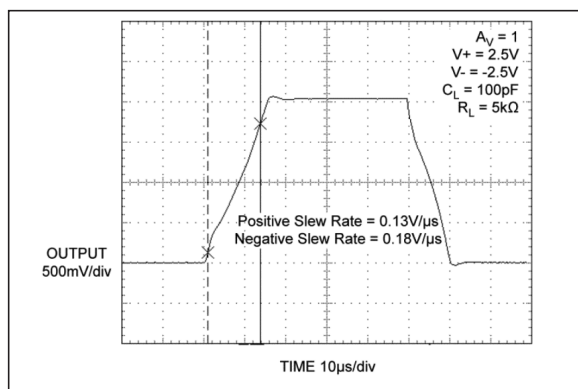


**FIGURE 2-36:** Rail to Rail Output Operation.

# MIC861

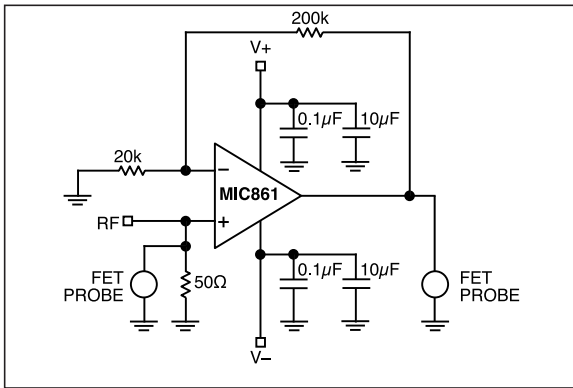


**FIGURE 2-37:** Large Signal Pulse Response (See Figure 3-3).

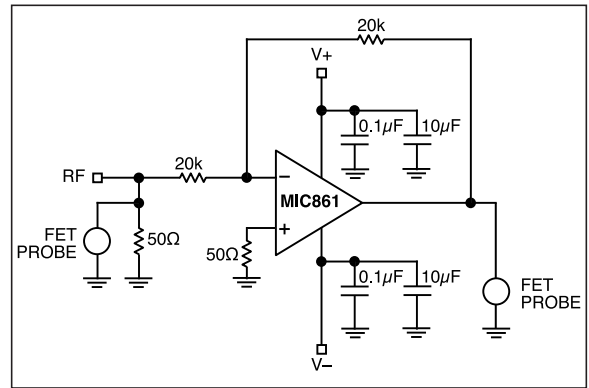


**FIGURE 2-38:** Large Signal Pulse Response (See Figure 3-3).

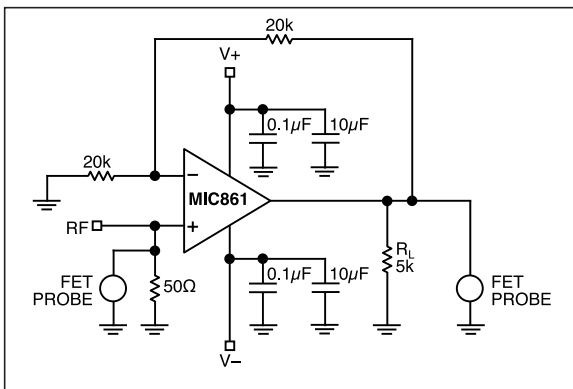
## 3.0 TEST CIRCUITS



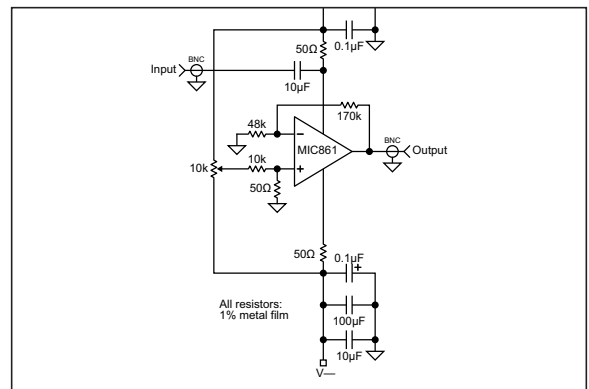
**FIGURE 3-1:** Test Circuit: 1  $A_V = 11$ .



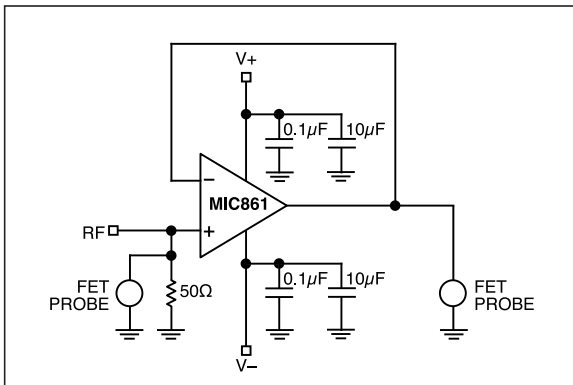
**FIGURE 3-4:** Test Circuit: 4  $A_V = -1$ .



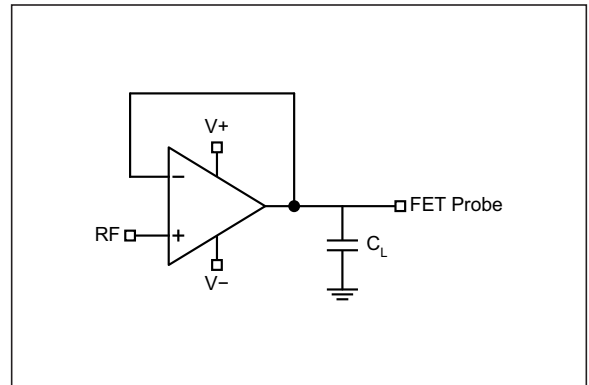
**FIGURE 3-2:** Test Circuit: 2  $A_V = 2$ .



**FIGURE 3-5:** Test Circuit: 5 Positive Power Supply Rejection Ratio Measurement.



**FIGURE 3-3:** Test Circuit: 3  $A_V = 1$ .



**FIGURE 3-6:** Test Circuit: 6 Closed-Loop Unity Gain Frequency Response Measurement.

# MIC861

---

## 4.0 PIN DESCRIPTIONS

The descriptions of the pins are listed in [Table 4-1](#).

**TABLE 4-1: PIN FUNCTION TABLE**

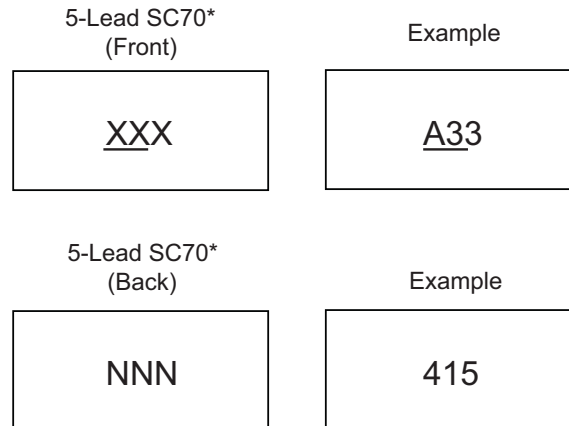
Pin Number	Symbol	Description
1	IN+	Non-inverting input.
2	V-	Negative power supply connection. Connect a 10 $\mu$ F and 0.1 $\mu$ F capacitor in parallel to this pin for power supply bypassing.
3	IN-	Inverting Input.
4	OUT	Output of operational amplifier.
5	V+	Positive power supply input. Connect a 10 $\mu$ F and 0.1 $\mu$ F capacitor in parallel to this pin for power supply bypassing.

## 5.0 APPLICATION INFORMATION

Regular supply bypassing techniques are recommended. A 10  $\mu\text{F}$  capacitor in parallel with a 0.1  $\mu\text{F}$  capacitor on both the positive and negative supplies is ideal. For best performance, all bypassing capacitors should be located as close to the op amp as possible and all capacitors should be low equivalent series inductance (ESL) and equivalent series resistance (ESR). Surface-mount ceramic capacitors are ideal.

## 6.0 PACKAGING INFORMATION

### 6.1 Package Marking Information



<p><b>Legend:</b> XX...X Product code or customer-specific information Y Year code (last digit of calendar year) YY Year code (last 2 digits of calendar year) WW Week code (week of January 1 is week '01') NNN Alphanumeric traceability code Ⓔ3 Pb-free JEDEC® designator for Matte Tin (Sn) * This package is Pb-free. The Pb-free JEDEC designator (Ⓔ3) can be found on the outer packaging for this package.</p> <p>•, ▲, ▼ Pin one index is identified by a dot, delta up, or delta down (triangle mark).</p>
<p><b>Note:</b> In the event the full Microchip part number cannot be marked on one line, it will be carried over to the next line, thus limiting the number of available characters for customer-specific information. Package may or may not include the corporate logo.</p> <p>Underbar ( <u> </u> ) and/or Overbar ( <sup> </sup> ) symbol may not be to scale.</p>

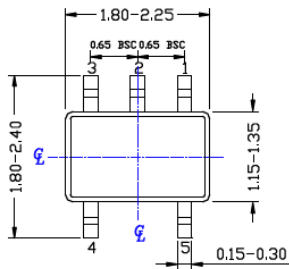


## 5-Lead SC70 Package Outline and Recommended Land Pattern

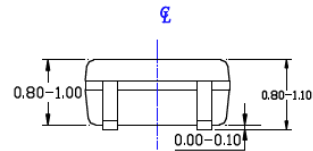
**TITLE**

5 LEAD SC70 PACKAGE OUTLINE & RECOMMENDED LAND PATTERN

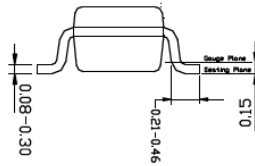
DRAWING #	SC70-5LD-PL-2	UNIT	MM
-----------	---------------	------	----



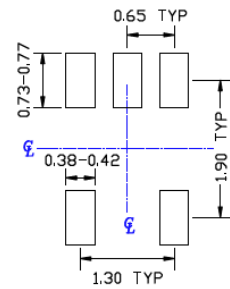
**TOP VIEW**



**SIDE VIEW**



**END VIEW**



**RECOMMENDED LAND PATTERN**

**NOTE:**

1. ALL DIMENSIONS ARE IN MILLIMETERS.
2. DIMENSIONS ARE INCLUSIVE OF PLATING.
3. DIMENSIONS ARE EXCLUSIVE OF MOLD FLASH & METAL BURR.

Note: For the most current package drawings, please see the Microchip Packaging Specification located at <http://www.microchip.com/packaging>.

# MIC861

---

NOTES:

## APPENDIX A: REVISION HISTORY

### Revision A (July 2020)

- Converted Micrel document MIC861 to Microchip data sheet template DS20006347A.
- Minor text changes throughout.

# MIC861

---

NOTES:

## PRODUCT IDENTIFICATION SYSTEM

To order or obtain information, e.g., on pricing or delivery, contact your local Microchip representative or sales office.

<u>PART NO.</u>	X	XX	-XX
Device	Temperature	Package	Media Type
<b>Device:</b> MIC861:		Ultra-Low Power Operational Amplifier	
<b>Temperature:</b> Y	=	-40°C to +85°C	
<b>Package:</b> C5	=	5-Lead SC70	
<b>Media Type:</b> TR	=	3,000/Reel	

**Examples:**

a) MIC861YC5-TR: Op Amp, -40°C to +85°C  
Junction Temperature Range, 5-Lead SC70  
Package, 3,000/Reel

**Note 1:** Tape and Reel identifier only appears in the catalog part number description. This identifier is used for ordering purposes and is not printed on the device package. Check with your Microchip Sales Office for package availability with the Tape and Reel option.

# MIC861

---

NOTES:

---

---

**Note the following details of the code protection feature on Microchip devices:**

- Microchip products meet the specification contained in their particular Microchip Data Sheet.
- Microchip believes that its family of products is one of the most secure families of its kind on the market today, when used in the intended manner and under normal conditions.
- There are dishonest and possibly illegal methods used to breach the code protection feature. All of these methods, to our knowledge, require using the Microchip products in a manner outside the operating specifications contained in Microchip's Data Sheets. Most likely, the person doing so is engaged in theft of intellectual property.
- Microchip is willing to work with the customer who is concerned about the integrity of their code.
- Neither Microchip nor any other semiconductor manufacturer can guarantee the security of their code. Code protection does not mean that we are guaranteeing the product as “unbreakable.”

Code protection is constantly evolving. We at Microchip are committed to continuously improving the code protection features of our products. Attempts to break Microchip's code protection feature may be a violation of the Digital Millennium Copyright Act. If such acts allow unauthorized access to your software or other copyrighted work, you may have a right to sue for relief under that Act.

---

Information contained in this publication regarding device applications and the like is provided only for your convenience and may be superseded by updates. It is your responsibility to ensure that your application meets with your specifications. MICROCHIP MAKES NO REPRESENTATIONS OR WARRANTIES OF ANY KIND WHETHER EXPRESS OR IMPLIED, WRITTEN OR ORAL, STATUTORY OR OTHERWISE, RELATED TO THE INFORMATION, INCLUDING BUT NOT LIMITED TO ITS CONDITION, QUALITY, PERFORMANCE, MERCHANTABILITY OR FITNESS FOR PURPOSE. Microchip disclaims all liability arising from this information and its use. Use of Microchip devices in life support and/or safety applications is entirely at the buyer's risk, and the buyer agrees to defend, indemnify and hold harmless Microchip from any and all damages, claims, suits, or expenses resulting from such use. No licenses are conveyed, implicitly or otherwise, under any Microchip intellectual property rights unless otherwise stated.

### Trademarks

The Microchip name and logo, the Microchip logo, Adaptec, AnyRate, AVR, AVR logo, AVR Freaks, BesTime, BitCloud, chipKIT, chipKIT logo, CryptoMemory, CryptoRF, dsPIC, FlashFlex, flexPWR, HELDO, IGLOO, JukeBlox, KeeLoq, Klear, LANCheck, LinkMD, maXStylus, maXTouch, MediaLB, megaAVR, Microsemi, Microsemi logo, MOST, MOST logo, MPLAB, OptoLyzer, PackeTime, PIC, picoPower, PICSTART, PIC32 logo, PolarFire, Prochip Designer, QTouch, SAM-BA, SenGenuity, SpyNIC, SST, SST Logo, SuperFlash, Symmetricom, SyncServer, Tachyon, TempTrackr, TimeSource, tinyAVR, UNI/O, Vectron, and XMEGA are registered trademarks of Microchip Technology Incorporated in the U.S.A. and other countries.

APT, ClockWorks, The Embedded Control Solutions Company, EtherSynch, FlashTec, Hyper Speed Control, HyperLight Load, IntelliMOS, Libero, motorBench, mTouch, Powermite 3, Precision Edge, ProASIC, ProASIC Plus, ProASIC Plus logo, Quiet-Wire, SmartFusion, SyncWorld, Temux, TimeCesium, TimeHub, TimePictra, TimeProvider, Vite, WinPath, and ZL are registered trademarks of Microchip Technology Incorporated in the U.S.A.

Adjacent Key Suppression, AKS, Analog-for-the-Digital Age, Any Capacitor, AnyIn, AnyOut, BlueSky, BodyCom, CodeGuard, CryptoAuthentication, CryptoAutomotive, CryptoCompanion, CryptoController, dsPICDEM, dsPICDEM.net, Dynamic Average Matching, DAM, ECAN, EtherGREEN, In-Circuit Serial Programming, ICSP, INICnet, Inter-Chip Connectivity, JitterBlocker, KlearNet, KlearNet logo, memBrain, Mindi, MiWi, MPASM, MPF, MPLAB Certified logo, MPLIB, MPLINK, MultiTRAK, NetDetach, Omniscient Code Generation, PICDEM, PICDEM.net, PICKit, PICtail, PowerSmart, PureSilicon, QMatrix, REAL ICE, Ripple Blocker, SAM-ICE, Serial Quad I/O, SMART-I.S., SQI, SuperSwitcher, SuperSwitcher II, Total Endurance, TSHARC, USBCheck, VariSense, ViewSpan, WiperLock, Wireless DNA, and ZENA are trademarks of Microchip Technology Incorporated in the U.S.A. and other countries.

SQTP is a service mark of Microchip Technology Incorporated in the U.S.A.

The Adaptec logo, Frequency on Demand, Silicon Storage Technology, and Symmcom are registered trademarks of Microchip Technology Inc. in other countries.

GestIC is a registered trademark of Microchip Technology Germany II GmbH & Co. KG, a subsidiary of Microchip Technology Inc., in other countries.

All other trademarks mentioned herein are property of their respective companies.

© 2020, Microchip Technology Incorporated, All Rights Reserved.

ISBN: 978-1-5224-6418-1

For information regarding Microchip's Quality Management Systems, please visit [www.microchip.com/quality](http://www.microchip.com/quality).



# MICROCHIP

## Worldwide Sales and Service

### AMERICAS

**Corporate Office**  
2355 West Chandler Blvd.  
Chandler, AZ 85224-6199  
Tel: 480-792-7200  
Fax: 480-792-7277  
Technical Support:  
<http://www.microchip.com/support>  
Web Address:  
[www.microchip.com](http://www.microchip.com)

#### Atlanta

Duluth, GA  
Tel: 678-957-9614  
Fax: 678-957-1455

#### Austin, TX

Tel: 512-257-3370

#### Boston

Westborough, MA  
Tel: 774-760-0087  
Fax: 774-760-0088

#### Chicago

Itasca, IL  
Tel: 630-285-0071  
Fax: 630-285-0075

#### Dallas

Addison, TX  
Tel: 972-818-7423  
Fax: 972-818-2924

#### Detroit

Novi, MI  
Tel: 248-848-4000

#### Houston, TX

Tel: 281-894-5983

#### Indianapolis

Noblesville, IN  
Tel: 317-773-8323  
Fax: 317-773-5453  
Tel: 317-536-2380

#### Los Angeles

Mission Viejo, CA  
Tel: 949-462-9523  
Fax: 949-462-9608  
Tel: 951-273-7800

#### Raleigh, NC

Tel: 919-844-7510

#### New York, NY

Tel: 631-435-6000

#### San Jose, CA

Tel: 408-735-9110  
Tel: 408-436-4270

#### Canada - Toronto

Tel: 905-695-1980  
Fax: 905-695-2078

### ASIA/PACIFIC

**Australia - Sydney**  
Tel: 61-2-9868-6733

**China - Beijing**  
Tel: 86-10-8569-7000

**China - Chengdu**  
Tel: 86-28-8665-5511

**China - Chongqing**  
Tel: 86-23-8980-9588

**China - Dongguan**  
Tel: 86-769-8702-9880

**China - Guangzhou**  
Tel: 86-20-8755-8029

**China - Hangzhou**  
Tel: 86-571-8792-8115

**China - Hong Kong SAR**  
Tel: 852-2943-5100

**China - Nanjing**  
Tel: 86-25-8473-2460

**China - Qingdao**  
Tel: 86-532-8502-7355

**China - Shanghai**  
Tel: 86-21-3326-8000

**China - Shenyang**  
Tel: 86-24-2334-2829

**China - Shenzhen**  
Tel: 86-755-8864-2200

**China - Suzhou**  
Tel: 86-186-6233-1526

**China - Wuhan**  
Tel: 86-27-5980-5300

**China - Xian**  
Tel: 86-29-8833-7252

**China - Xiamen**  
Tel: 86-592-2388138

**China - Zhuhai**  
Tel: 86-756-3210040

### ASIA/PACIFIC

**India - Bangalore**  
Tel: 91-80-3090-4444

**India - New Delhi**  
Tel: 91-11-4160-8631

**India - Pune**  
Tel: 91-20-4121-0141

**Japan - Osaka**  
Tel: 81-6-6152-7160

**Japan - Tokyo**  
Tel: 81-3-6880-3770

**Korea - Daegu**  
Tel: 82-53-744-4301

**Korea - Seoul**  
Tel: 82-2-554-7200

**Malaysia - Kuala Lumpur**  
Tel: 60-3-7651-7906

**Malaysia - Penang**  
Tel: 60-4-227-8870

**Philippines - Manila**  
Tel: 63-2-634-9065

**Singapore**  
Tel: 65-6334-8870

**Taiwan - Hsin Chu**  
Tel: 886-3-577-8366

**Taiwan - Kaohsiung**  
Tel: 886-7-213-7830

**Taiwan - Taipei**  
Tel: 886-2-2508-8600

**Thailand - Bangkok**  
Tel: 66-2-694-1351

**Vietnam - Ho Chi Minh**  
Tel: 84-28-5448-2100

### EUROPE

**Austria - Wels**  
Tel: 43-7242-2244-39  
Fax: 43-7242-2244-393

**Denmark - Copenhagen**  
Tel: 45-4485-5910  
Fax: 45-4485-2829

**Finland - Espoo**  
Tel: 358-9-4520-820

**France - Paris**  
Tel: 33-1-69-53-63-20  
Fax: 33-1-69-30-90-79

**Germany - Garching**  
Tel: 49-8931-9700

**Germany - Haan**  
Tel: 49-2129-3766400

**Germany - Heilbronn**  
Tel: 49-7131-72400

**Germany - Karlsruhe**  
Tel: 49-721-625370

**Germany - Munich**  
Tel: 49-89-627-144-0  
Fax: 49-89-627-144-44

**Germany - Rosenheim**  
Tel: 49-8031-354-560

**Israel - Ra'anana**  
Tel: 972-9-744-7705

**Italy - Milan**  
Tel: 39-0331-742611  
Fax: 39-0331-466781

**Italy - Padova**  
Tel: 39-049-7625286

**Netherlands - Drunen**  
Tel: 31-416-690399  
Fax: 31-416-690340

**Norway - Trondheim**  
Tel: 47-7288-4388

**Poland - Warsaw**  
Tel: 48-22-3325737

**Romania - Bucharest**  
Tel: 40-21-407-87-50

**Spain - Madrid**  
Tel: 34-91-708-08-90  
Fax: 34-91-708-08-91

**Sweden - Gothenberg**  
Tel: 46-31-704-60-40

**Sweden - Stockholm**  
Tel: 46-8-5090-4654

**UK - Wokingham**  
Tel: 44-118-921-5800  
Fax: 44-118-921-5820