

## TPS370x-xx Processor Supervisory Circuits With Power-Fail

### 1 Features

- Power-on reset generator with fixed delay time of 200 ms (no external capacitor needed)
- Precision supply voltage monitor: 2.5 V, 3 V, 3.3 V, and 5 V
- Pin-for-pin compatible with the MAX705 through MAX708 Series
- Integrated watchdog time (TPS3705-xx Only)
- Voltage monitor for power-fail or low-battery warning
- Maximum supply current of 50  $\mu$ A
- 8-Pin MSOP and 8-Pin SOIC packages
- Temperature range:  $-40^{\circ}\text{C}$  to  $85^{\circ}\text{C}$  ( $-40^{\circ}\text{C}$  to  $125^{\circ}\text{C}$  for TPS3705-33)

### 2 Applications

- [Designs using DSPs, microcontrollers, or microprocessors](#)
- [Industrial equipment](#)
- [Programmable controls](#)
- [Automotive systems](#)
- [Portable or battery powered equipment](#)
- [Intelligent instruments](#)
- [Wireless communication systems](#)
- [Notebook or desktop computers](#)

### 3 Description

The TPS370x-xx family of microprocessor supply-voltage supervisors provide circuit initialization and timing supervision, primarily for DSP and processor-based systems.

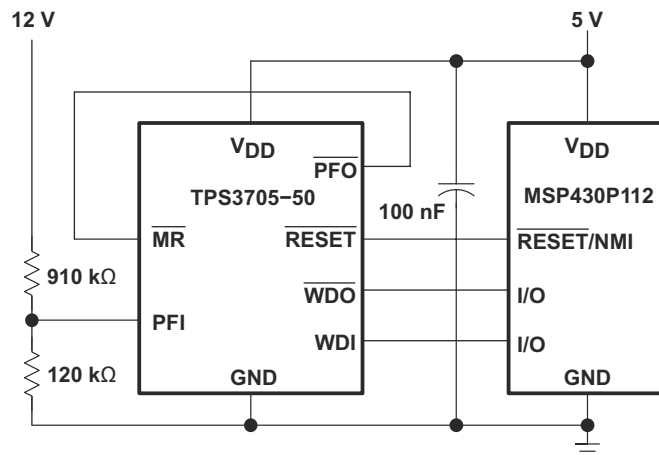
During power-on,  $\overline{\text{RESET}}$  is asserted when the supply voltage  $V_{\text{DD}}$  becomes higher than 1.1 V. Thereafter, the supply voltage supervisor monitors  $V_{\text{DD}}$  and keeps  $\overline{\text{RESET}}$  active as long as  $V_{\text{DD}}$  remains below the threshold voltage  $V_{\text{IT+}}$ . When the supply voltage drops below the threshold voltage  $V_{\text{IT-}}$ , the output becomes active (low) again. No external components are required. All the devices of this family have a fixed-sense threshold voltage  $V_{\text{IT-}}$  set by an internal voltage divider.

The product spectrum is designed for supply voltages of 2.5 V, 3 V, 3.3 V, and 5 V. The circuits are available in either 8-pin MSOP or standard SOIC packages. The TPS370x-xx devices are characterized for operation over a temperature range of  $-40^{\circ}\text{C}$  to  $85^{\circ}\text{C}$ .

#### Device Information (1)

PART NUMBER	PACKAGE	BODY SIZE (NOM)
TPS3705-xx, TPS3707-xx	MSOP- PowerPAD™ (8)	3.00 mm × 3.00 mm
	SOIC (8)	3.90 mm × 4.90 mm

(1) For all available packages, see the orderable addendum at the end of the data sheet.



Copyright © 2016, Texas Instruments Incorporated

### Typical MSP430 Application



## Table of Contents

<b>1 Features</b> .....	1	8.1 Overview.....	16
<b>2 Applications</b> .....	1	8.2 Functional Block Diagram.....	16
<b>3 Description</b> .....	1	8.3 Feature Description.....	16
<b>4 Revision History</b> .....	2	8.4 Device Functional Modes.....	17
<b>5 Device Comparison Table</b> .....	3	<b>9 Application and Implementation</b> .....	18
<b>6 Pin Configuration and Functions</b> .....	4	9.1 Application Information.....	18
6.1 Pin Functions.....	4	9.2 Typical Application.....	18
<b>7 Specifications</b> .....	5	<b>10 Power Supply Recommendations</b> .....	19
7.1 Absolute Maximum Ratings.....	5	<b>11 Layout</b> .....	20
7.2 ESD Ratings.....	5	11.1 Layout Guidelines.....	20
7.3 Recommended Operating Conditions.....	5	11.2 Layout Example.....	20
7.4 Thermal Information.....	6	<b>12 Device and Documentation Support</b> .....	21
7.5 Electrical Characteristics.....	7	12.1 Receiving Notification of Documentation Updates.....	21
7.6 Electrical Characteristics for TPS3705-33 Only.....	8	12.2 Support Resources.....	21
7.7 Timing Requirements.....	8	12.3 Trademarks.....	21
7.8 Switching Characteristics.....	9	12.4 Electrostatic Discharge Caution.....	21
7.9 Dissipation Ratings.....	9	12.5 Glossary.....	21
7.10 Timing Diagram.....	10	<b>13 Mechanical, Packaging, and Orderable Information</b> .....	21
7.11 Typical Characteristics.....	11		
<b>8 Detailed Description</b> .....	16		

## 4 Revision History

NOTE: Page numbers for previous revisions may differ from page numbers in the current version.

<b>Changes from Revision E (July 2017) to Revision F (October 2020)</b>	<b>Page</b>
• Updated the numbering format for tables, figures, and cross-references throughout the document.....	1
• Updated Device Comparison Table by adding -40°C to 125°C for TPS3705-33D.....	3
• Updated Absolute Maximum Ratings table to include Operating Temperature of -40°C to 125°C for TPS3705-33D.....	5
• Added TPS3705-33 Electrical Table.....	8
• Added histograms.....	11

<b>Changes from Revision D (May 2016) to Revision E (July 2017)</b>	<b>Page</b>
• Updated package body sizes in the <i>Device Information</i> table.....	1

<b>Changes from Revision C (December 2005) to Revision D (May 2016)</b>	<b>Page</b>
• Added <i>ESD Ratings</i> table, <i>Feature Description</i> section, <i>Device Functional Modes</i> , <i>Application and Implementation</i> section, <i>Power Supply Recommendations</i> section, <i>Layout</i> section, <i>Device and Documentation Support</i> section, and <i>Mechanical, Packaging, and Orderable Information</i> section.....	1

## 5 Device Comparison Table

T <sub>A</sub>	THRESHOLD VOLTAGE	PACKAGED DEVICES		MARKING DGN PACKAGE	CHIP FORM (Y)
		SMALL OUTLINE (D)	POWER-PAD μ-SMALL OUTLINE (DGN)		
-40°C to 85°C	2.63 V	TPS3705-30D	TPS3705-30DGN	TIAAT	TPS3705-30Y
	4.55 V	TPS3705-50D	TPS3705-50DGN	TIAAV	TPS3705-50Y
	2.25 V	TPS3707-25D	TPS3707-25DGN	TIAAW	TPS3707-25Y
	2.63 V	TPS3707-30D	TPS3707-30DGN	TIAAX	TPS3707-30Y
	2.93 V	TPS3707-33D	TPS3707-33DGN	TIAAY	TPS3707-33Y
	4.55 V	TPS3707-50D	TPS3707-50DGN	TIAAZ	TPS3707-50Y
-40°C to 125°C	2.93 V	TPS3705-33D	TPS3705-33DGN	TIAAU	TPS3705-33Y

## 6 Pin Configuration and Functions

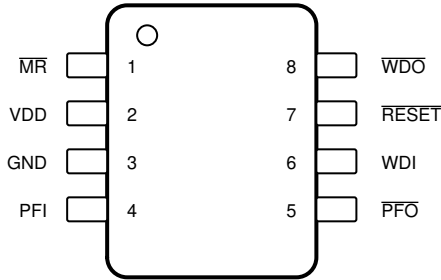


Figure 6-1. TPS3705-xx D Package 8-Pin SOIC Top View

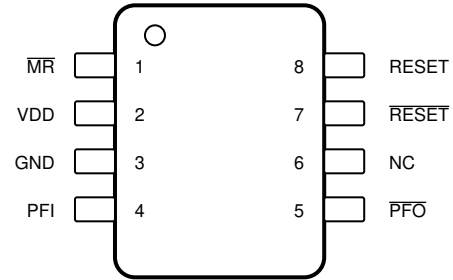


Figure 6-2. TPS3707-xx D Package 8-Pin SOIC Top View

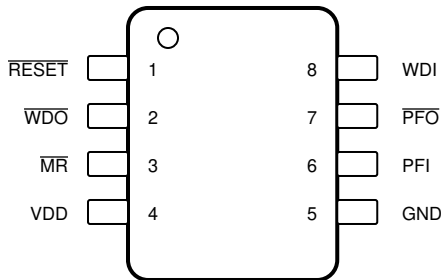


Figure 6-3. TPS3705-xx DGN Package 8-Pin MSOP-PowerPAD Top View

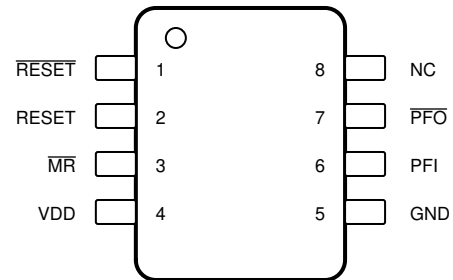


Figure 6-4. TPS3707-xx DGN Package 8-Pin MSOP-PowerPAD Top View

### 6.1 Pin Functions

NAME	PIN				I/O	DESCRIPTION
	TPS3705-xx		TPS3707-xx			
	SOIC	MSOP-PowerPAD	SOIC	MSOP-PowerPAD		
GND	3	5	3	5	—	Ground
MR	1	3	1	3	I	Manual reset
NC	—	—	6	8	—	No internal connection
PFI	4	6	4	6	I	Power-fail comparator input
PFO	5	7	5	7	O	Power-fail comparator output
RESET	7	1	7	1	O	Active-low reset output
RESET	—	—	8	2	O	Active-high reset output
V <sub>DD</sub>	2	4	2	4	—	Supply voltage
WDI	6	8	—	—	I	Watchdog timer input
WDO	8	2	—	—	O	Watchdog timer output

## 7 Specifications

### 7.1 Absolute Maximum Ratings

over operating free-air temperature range (unless otherwise noted)<sup>(1)</sup>

	MIN	MAX	UNIT
Supply voltage, $V_{DD}$ <sup>(2)</sup>		7	V
PFI voltage range, $V_{PFI}$	-0.3	$V_{DD} + 0.3$	V
All other pins <sup>(2)</sup>	-0.3	7	V
Maximum low output current, $I_{OL}$		5	mA
Maximum high output current, $I_{OH}$		-5	mA
Input clamp current, $I_{IK}$ ( $V_I < 0$ or $V_I > V_{DD}$ )		$\pm 20$	mA
Output clamp current, $I_{OK}$ ( $V_O < 0$ or $V_O > V_{DD}$ )		$\pm 20$	mA
Continuous total power dissipation	See <a href="#">Section 7.9</a>		
Soldering temperature		260	°C
Operating temperature, $T_A$	-40	85	°C
Operating temperature, $T_A$ for TPS3705-33 only	-40	125	°C
Storage temperature, $T_{stg}$	-65	150	°C

- (1) Stresses beyond those listed under *Absolute Maximum Ratings* may cause permanent damage to the device. These are stress ratings only, which do not imply functional operation of the device at these or any other conditions beyond those indicated under *Recommended Operating Conditions*. Exposure to absolute-maximum-rated conditions for extended periods may affect device reliability.
- (2) All voltage values are with respect to GND. For reliable operation the device must not be operated at 7 V for more than  $t = 1000h$  continuously.

### 7.2 ESD Ratings

		VALUE	UNIT
$V_{(ESD)}$ Electrostatic discharge	Human-body model (HBM), per ANSI/ESDA/JEDEC JS-001 <sup>(1)</sup>	$\pm 2000$	V
	Charged-device model (CDM), per JEDEC specification JESD22-C101 <sup>(2)</sup>	$\pm 500$	

- (1) JEDEC document JEP155 states that 500-V HBM allows safe manufacturing with a standard ESD control process.
- (2) JEDEC document JEP157 states that 250-V CDM allows safe manufacturing with a standard ESD control process.

### 7.3 Recommended Operating Conditions

over operating free-air temperature range (unless otherwise noted)

		MIN	NOM	MAX	UNIT
$V_{DD}$	Supply voltage	2		6	V
$V_I$	Input voltage	0		$V_{DD} + 0.3$	V
$V_{IH}$	High-level input voltage	$0.7 \times V_{DD}$			V
$V_{IL}$	Low-level input voltage		$0.3 \times V_{DD}$		V
$\Delta t/\Delta V$	Input transition rise and fall rate at $\overline{MR}$ or $WDI$			100	ns/V
$T_A$	Operating free-air temperature	-40		85	°C
$T_A$	Operating free-air temperature for TPS3705-33 only	-40		125	°C

## 7.4 Thermal Information

THERMAL METRIC <sup>(1)</sup>		TPS3705-xx	TPS3707-xx	UNIT
		D (SOIC)	DGN (MSOP-PowerPAD)	
		8 PINS	8 PINS	
$R_{\theta JA}$	Junction-to-ambient thermal resistance	118.2	66.1	°C/W
$R_{\theta JC(top)}$	Junction-to-case (top) thermal resistance	64.4	62.6	°C/W
$R_{\theta JB}$	Junction-to-board thermal resistance	58.5	45.1	°C/W
$\psi_{JT}$	Junction-to-top characterization parameter	15.8	7.6	°C/W
$\psi_{JB}$	Junction-to-board characterization parameter	57.9	44.8	°C/W
$R_{\theta JC(bot)}$	Junction-to-case (bottom) thermal resistance	—	18.5	°C/W

- (1) For more information about traditional and new thermal metrics, see the [Semiconductor and IC Package Thermal Metrics](#) application report.

## 7.5 Electrical Characteristics

over operating free-air temperature range (unless otherwise noted)

PARAMETER		TEST CONDITIONS	MIN	TYP	MAX	UNIT
V <sub>OH</sub>	High-level output voltage	TPS370x-xx, V <sub>DD</sub> = 1.1 V, I <sub>OH</sub> = -4 μA	0.8			V
		TPS3707-25, TPS370x-30, TPS370x-33, V <sub>DD</sub> = V <sub>IT+</sub> + 0.2 V, I <sub>OH</sub> = -500 μA	0.7 × V <sub>DD</sub>			
		TPS370x-50, V <sub>DD</sub> = V <sub>IT+</sub> + 0.2 V, I <sub>OH</sub> = -800 μA	V <sub>DD</sub> - 1.5			
		TPS370x-xx, V <sub>DD</sub> = 6 V, I <sub>OH</sub> = -800 μA	V <sub>DD</sub> - 1.5			
V <sub>OL</sub>	Low-level output voltage	TPS3707-25, TPS370x-30, TPS370x-33, V <sub>DD</sub> = V <sub>IT+</sub> + 0.2 V, I <sub>OL</sub> = 1 mA	0.3			V
		TPS370x-50, V <sub>DD</sub> = V <sub>IT+</sub> + 0.2 V, I <sub>OL</sub> = 2.5 mA	0.4			
		TPS370x-xx, V <sub>DD</sub> = 6 V, I <sub>OL</sub> = 3 mA	0.4			
Power-up reset voltage <sup>(1)</sup>		V <sub>DD</sub> ≥ 1.1 V, I <sub>OL</sub> = 50 μA	0.3			V
V <sub>IT-</sub>	Negative-going input threshold voltage <sup>(2)</sup>	TPS3707-25, T <sub>A</sub> = 0°C to 85°C	2.2	2.25	2.3	V
		TPS370x-30, T <sub>A</sub> = 0°C to 85°C	2.57	2.63	2.68	
		TPS370x-33, T <sub>A</sub> = 0°C to 85°C	2.87	2.93	2.98	
		TPS370x-50, T <sub>A</sub> = 0°C to 85°C	4.45	4.55	4.63	
		TPS3707-25, T <sub>A</sub> = -40°C to 85°C	2.2	2.25	2.32	
		TPS370x-30, T <sub>A</sub> = -40°C to 85°C	2.57	2.63	2.7	
		TPS370x-33, T <sub>A</sub> = -40°C to 85°C	2.87	2.93	3	
	TPS370x-50, T <sub>A</sub> = -40°C to 85°C	4.45	4.55	4.65		
	Negative-going input threshold voltage, PFI <sup>(2)</sup>	TPS370x-xx, V <sub>DD</sub> ≥ 2 V, T <sub>A</sub> = -40°C to 85°C	1.2	1.25	1.3	
V <sub>hys</sub>	Hysteresis, V <sub>DD</sub>	TPS3707-25	40			mV
		TPS370x-30	50			
		TPS370x-33	50			
		TPS370x-50	70			
	Hysteresis, PFI	TPS370x-xx	10			
I <sub>IH(AV)</sub>	Average high-level input current, WDI	WDI = V <sub>DD</sub> = 6 V, time average (dc = 88%)		100	150	μA
I <sub>IL(AV)</sub>	Average low-level input current, WDI	WDI = 0 V, V <sub>DD</sub> = 6 V, time average (dc = 12%)		-15	-20	μA
I <sub>IH</sub>	High-level input current, WDI	WDI = V <sub>DD</sub> = 6 V		120	170	μA
	High-level input current, MR	MR = 0.7 × V <sub>DD</sub> , V <sub>DD</sub> = 6 V		-130	-180	
I <sub>IL</sub>	Low-level input current, WDI	WDI = 0 V, V <sub>DD</sub> = 6 V		-120	-170	μA
	Low-level input current, MR	MR = 0 V, V <sub>DD</sub> = 6 V		-430	-600	
I <sub>I</sub>	Input current, PFI	V <sub>DD</sub> = 6 V, 0 V ≤ V <sub>I</sub> ≤ V <sub>DD</sub>	-1	0	1	μA
I <sub>DD</sub>	Supply current	TPS3705-xx, V <sub>DD</sub> = 2 V to 6 V, MR = V <sub>DD</sub> , MR, WDI and outputs unconnected		30	50	μA
		TPS3707-xx, V <sub>DD</sub> = 2 V to 6 V, MR = V <sub>DD</sub> , MR, WDI and outputs unconnected		20	50	
C <sub>i</sub>	Input capacitance	V <sub>I</sub> = 0 V to V <sub>DD</sub>		5		pF

(1) The lowest supply voltage at which RESET becomes active, t<sub>r,VDD</sub> ≥ 15 μs/V

(2) To ensure best stability of the threshold voltage, a bypass capacitor (ceramic, 0.1 μF) should be placed near to the supply terminals

## 7.6 Electrical Characteristics for TPS3705-33 Only

over operating free-air temperature range -40 to 125°C (unless otherwise noted)

PARAMETER		TEST CONDITIONS	MIN	TYP	MAX	UNIT
V <sub>OH</sub>	High-level output voltage	V <sub>DD</sub> = 1.1 V, I <sub>OH</sub> = -4 μA	0.8			V
		V <sub>DD</sub> = V <sub>IT+</sub> + 0.2 V, I <sub>OH</sub> = -500 μA	0.7 × V <sub>DD</sub>			
		V <sub>DD</sub> = 6 V, I <sub>OH</sub> = -800 μA	V <sub>DD</sub> - 1.5			
V <sub>OL</sub>	Low-level output voltage	V <sub>DD</sub> = V <sub>IT+</sub> + 0.2 V, I <sub>OL</sub> = 1 mA	0.3			V
		V <sub>DD</sub> = 6 V, I <sub>OL</sub> = 3 mA	0.4			
Power-up reset voltage <sup>(1)</sup>		V <sub>DD</sub> ≥ 1.1 V, I <sub>OL</sub> = 50 μA	0.3			V
V <sub>IT-</sub>	Negative-going input threshold voltage	T <sub>A</sub> = 0°C to 125°C	2.87	2.93	3	V
		T <sub>A</sub> = -40°C to 125°C	2.87	2.93	3.02	
	Negative-going input threshold voltage, PFI <sup>(2)</sup>	V <sub>DD</sub> ≥ 2 V	1.2	1.25	1.3	
V <sub>hys</sub>	Hysteresis, V <sub>DD</sub>		50			mV
	Hysteresis, PFI		10			
I <sub>IH(AV)</sub>	Average high-level input current, WDI	WDI = V <sub>DD</sub> = 6 V, time average (dc = 88%)		100	150	μA
I <sub>IL(AV)</sub>	Average low-level input current, WDI	WDI = 0 V, V <sub>DD</sub> = 6 V, time average (dc = 12%)		-15	-20	μA
I <sub>IH</sub>	High-level input current, WDI	WDI = V <sub>DD</sub> = 6 V		120	170	μA
	High-level input current, MR	MR = 0.7 × V <sub>DD</sub> , V <sub>DD</sub> = 6 V		-130	-180	
I <sub>IL</sub>	Low-level input current, WDI	WDI = 0 V, V <sub>DD</sub> = 6 V		-120	-170	μA
	Low-level input current, MR	MR = 0 V, V <sub>DD</sub> = 6 V		-430	-600	
I <sub>I</sub>	Input current, PFI	V <sub>DD</sub> = 6 V, 0 V ≤ V <sub>I</sub> ≤ V <sub>DD</sub>	-1	0	1	μA
I <sub>DD</sub>	Supply current	V <sub>DD</sub> = 2 V to 6 V, MR = V <sub>DD</sub> , MR, WDI and outputs unconnected		30	50	μA
C <sub>i</sub>	Input capacitance	V <sub>I</sub> = 0 V to V <sub>DD</sub>		5		pF

## 7.7 Timing Requirements

at R<sub>L</sub> = 1 MΩ, C<sub>L</sub> = 50 pF, T<sub>A</sub> = 25°C (unless otherwise noted)

PARAMETER	TEST CONDITIONS	MIN	NOM	MAX	UNIT
t <sub>w</sub>	At V <sub>DD</sub> , V <sub>DD</sub> = V <sub>IT+</sub> + 0.2 V, V <sub>DD</sub> = V <sub>IT-</sub> - 0.2 V	6			μs
	At MR and WDI, V <sub>DD</sub> ≥ V <sub>IT+</sub> + 0.2 V, V <sub>IL</sub> = 0.3 × V <sub>DD</sub> , V <sub>IH</sub> = 0.7 × V <sub>DD</sub>	100			ns



## 7.8 Switching Characteristics

at  $R_L = 1\text{ M}\Omega$ ,  $C_L = 50\text{ pF}$ ,  $T_A = 25^\circ\text{C}$  (unless otherwise noted)

PARAMETER		TEST CONDITIONS	MIN	TYP	MAX	UNIT
$t_{t(out)}$	Watchdog time out	$V_{DD} \geq V_{IT+} + 0.2\text{ V}$ , see <a href="#">Figure 7-1</a>	1.1	1.6	2.3	s
$t_d$	Delay time	$V_{DD} \geq V_{IT+} + 0.2\text{ V}$ , see <a href="#">Figure 7-1</a>	140	200	280	ms
$t_{PHL}$	Propagation (delay) time, high-to-low-level output	$\overline{MR}$ to $\overline{RESET}$ delay, $V_{DD} \geq V_{IT+} + 0.2\text{ V}$ , $V_{IL} = 0.3 \times V_{DD}$ , $V_{IH} = 0.7 \times V_{DD}$		50	250	ns
$t_{PLH}$	Propagation (delay) time, low-to-high-level output	$\overline{MR}$ to $\overline{RESET}$ delay (TPS3707-xx only) $V_{DD} \geq V_{IT+} + 0.2\text{ V}$ , $V_{IL} = 0.3 \times V_{DD}$ , $V_{IH} = 0.7 \times V_{DD}$		50	250	ns
$t_{PHL}$	Propagation (delay) time, high-to-low-level output	$V_{DD}$ to $\overline{RESET}$ delay		3	5	$\mu\text{s}$
$t_{PLH}$	Propagation (delay) time, low-to-high-level output	$V_{DD}$ to $\overline{RESET}$ delay (TPS3707-xx only)		3	5	$\mu\text{s}$
$t_{PHL}$	Propagation (delay) time, high-to-low-level output	PFI to $\overline{PF\overline{O}}$ delay, $V_{DD} = 2\text{ V}$ to $6\text{ V}$		0.5	1	$\mu\text{s}$
$t_{PLH}$	Propagation (delay) time, low-to-high-level output	PFI to $\overline{PF\overline{O}}$ delay, $V_{DD} = 2\text{ V}$ to $6\text{ V}$		0.5	1	$\mu\text{s}$

## 7.9 Dissipation Ratings

PACKAGE	$T_A < 25^\circ\text{C}$ POWER RATING	DERATING FACTOR ABOVE $T_A = 25^\circ\text{C}$	$T_A = 70^\circ\text{C}$ POWER RATING	$T_A = 85^\circ\text{C}$ POWER RATING
DGN	2.14 W	17.1 mW/ $^\circ\text{C}$	1.37 W	1.11 W
D	725 mW	5.8 mW/ $^\circ\text{C}$	464 mW	377 mW

## 7.10 Timing Diagram

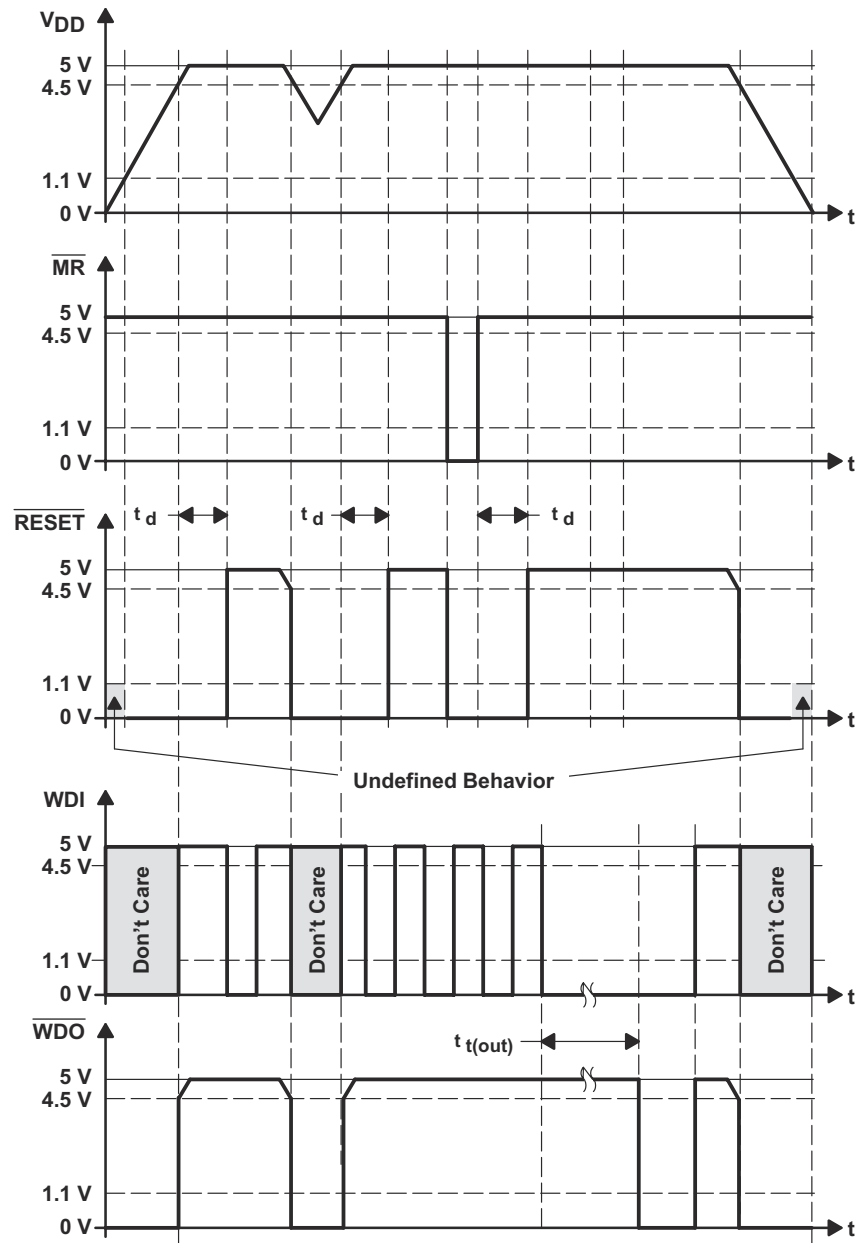
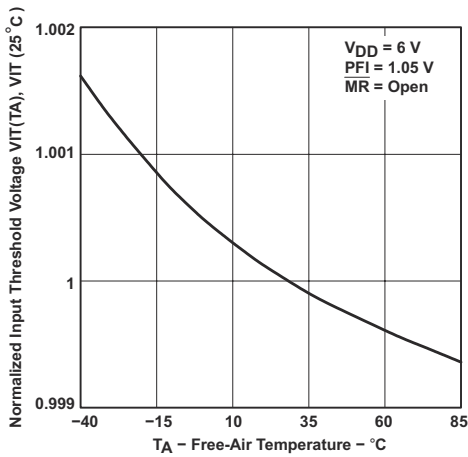
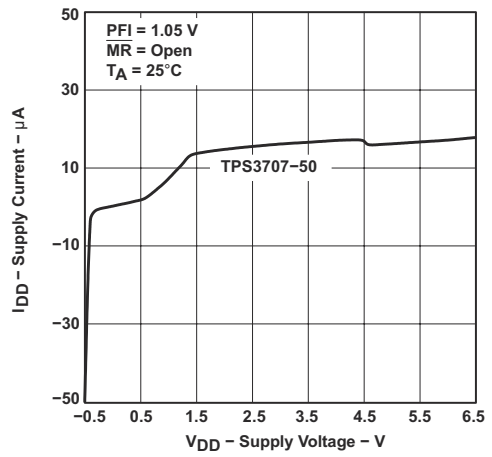


Figure 7-1. Timing Diagrams

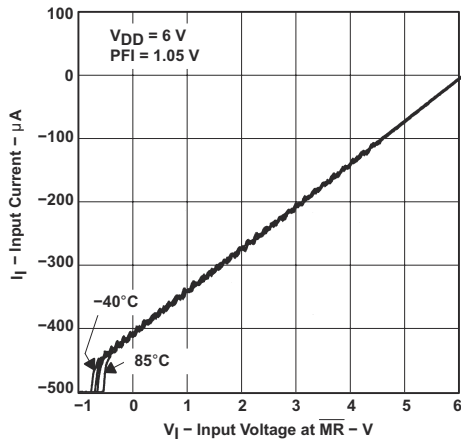
### 7.11 Typical Characteristics



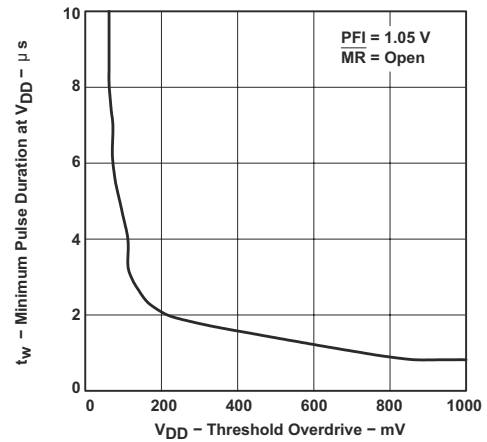
**Figure 7-2. Normalized Input Threshold Voltage vs Free-Air Temperature at  $V_{DD}$**



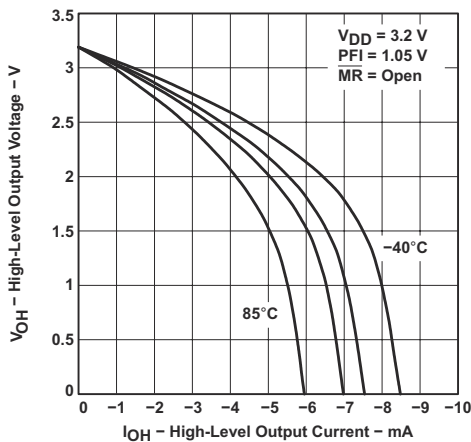
**Figure 7-3. Supply Current vs Supply Voltage**



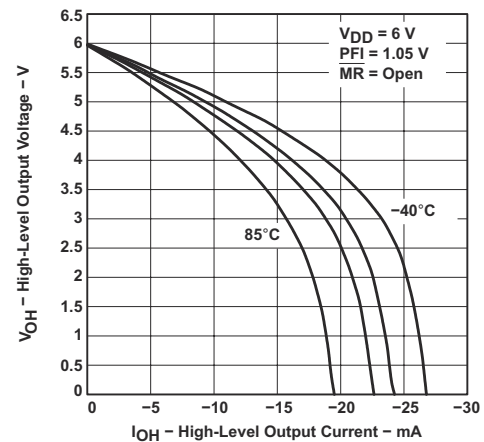
**Figure 7-4. Input Current vs Input Voltage at  $\overline{MR}$**



**Figure 7-5. Minimum Pulse Duration at  $V_{DD}$  vs  $V_{DD}$  Threshold Overdrive**

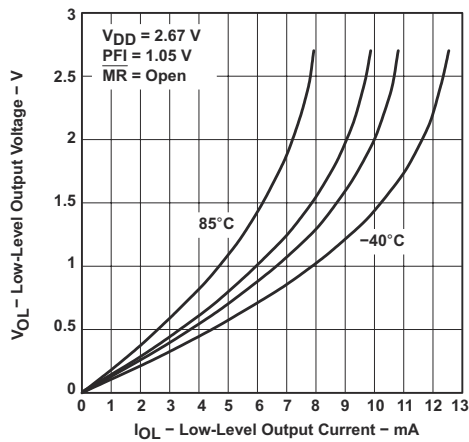


**Figure 7-6. High-Level Output Voltage vs High-Level Output Current**

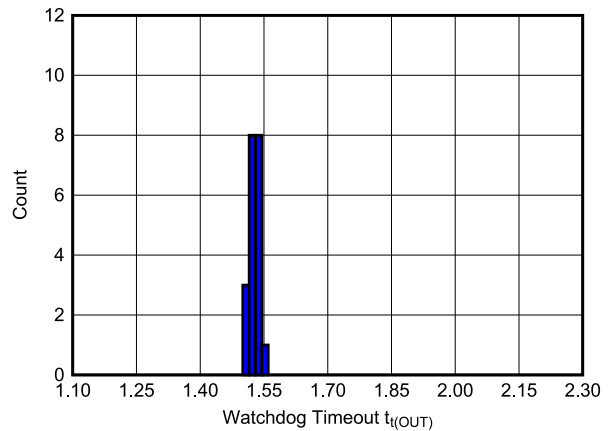


**Figure 7-7. High-Level Output Voltage vs High-Level Output Current**

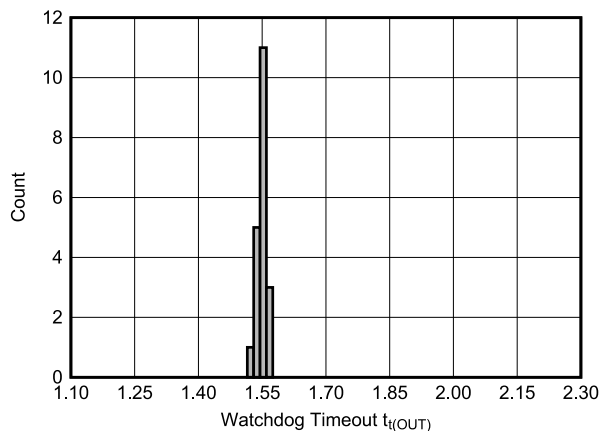
### 7.11 Typical Characteristics (continued)



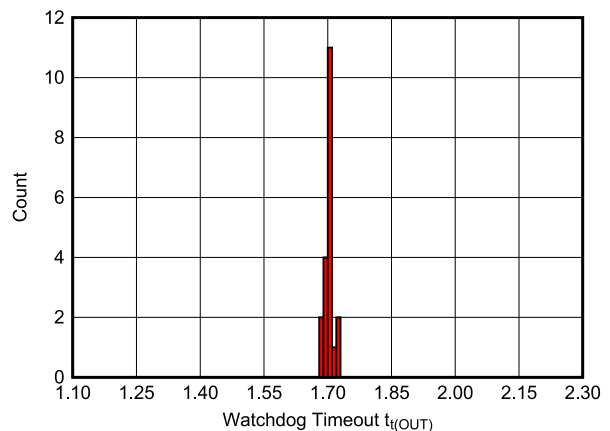
**Figure 7-8. Low-Level Output Voltage vs Low-Level Output Current**



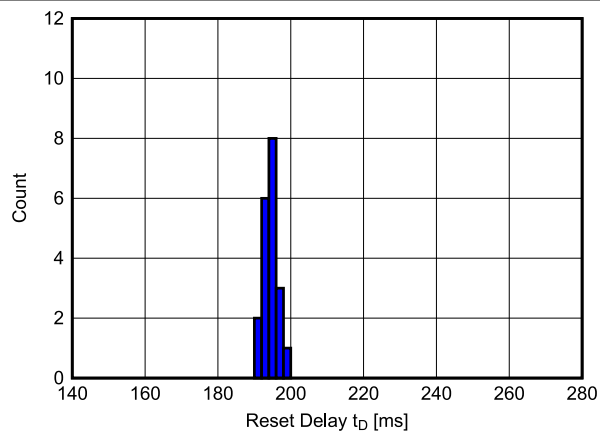
**Figure 7-9. Watchdog Timeout Histogram for TSP3705-33 Devices at -40°C (Unit Count = 20)**



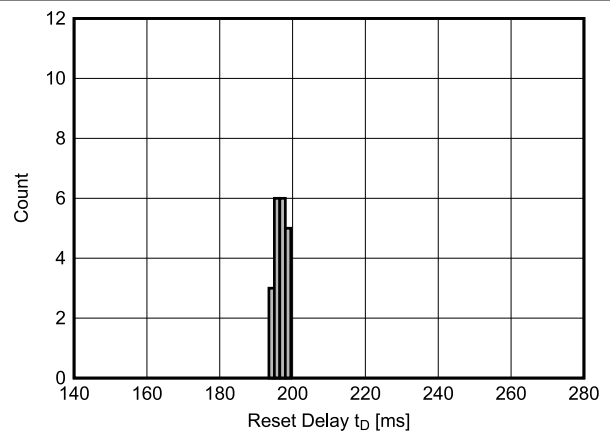
**Figure 7-10. Watchdog Timeout Histogram for TSP3705-33 Devices at 25°C (Unit Count = 20)**



**Figure 7-11. Watchdog Timeout Histogram for TSP3705-33 Devices at 125°C (Unit Count = 20)**

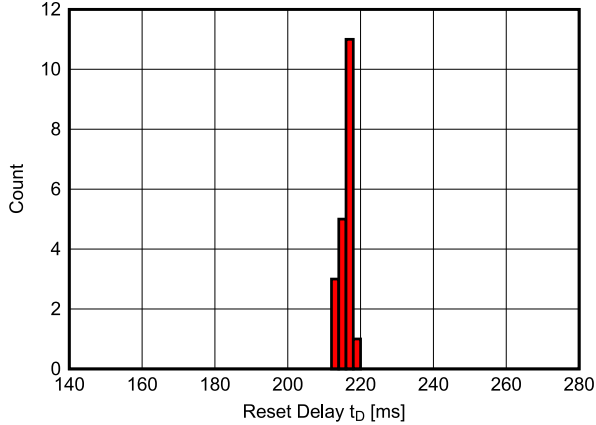


**Figure 7-12. Reset Delay Histogram for TPS3705-33 Devices at -40°C (Unit Count = 20)**

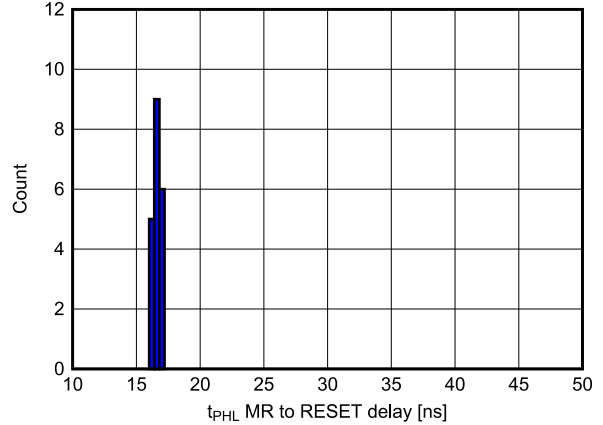


**Figure 7-13. Reset Delay Histogram for TPS3705-33 Devices at 25°C (Unit Count = 20)**

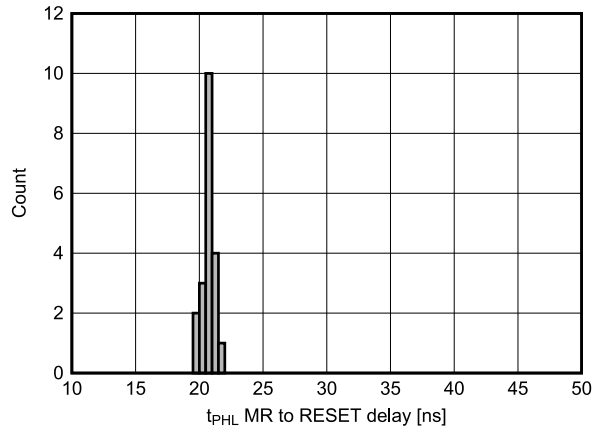
### 7.11 Typical Characteristics (continued)



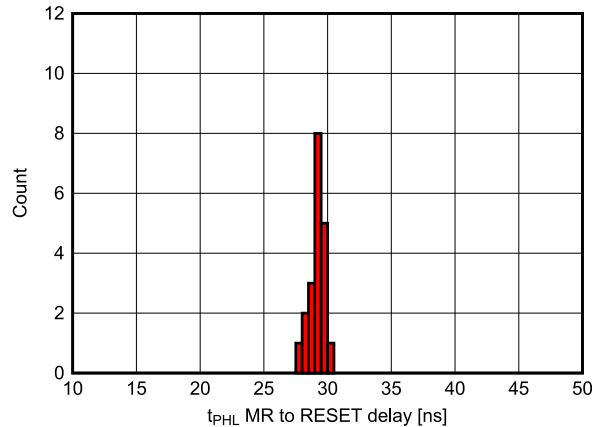
**Figure 7-14. Reset Delay Histogram for TPS3705-33 Devices at 125°C (Unit Count = 20)**



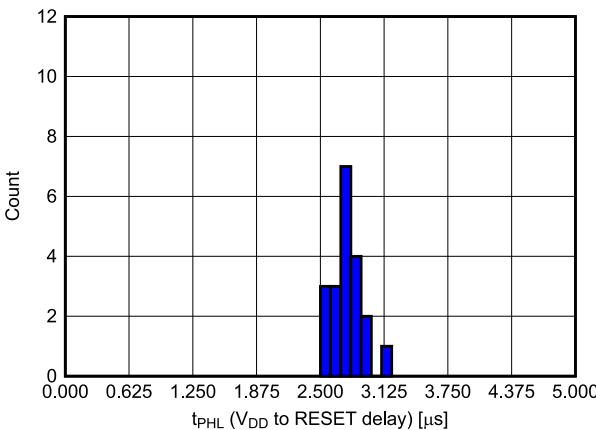
**Figure 7-15. MR to RESET ( $t_{PHL}$ ) Delay Histogram for TPS3705-33 Devices at -40°C (Unit Count = 20)**



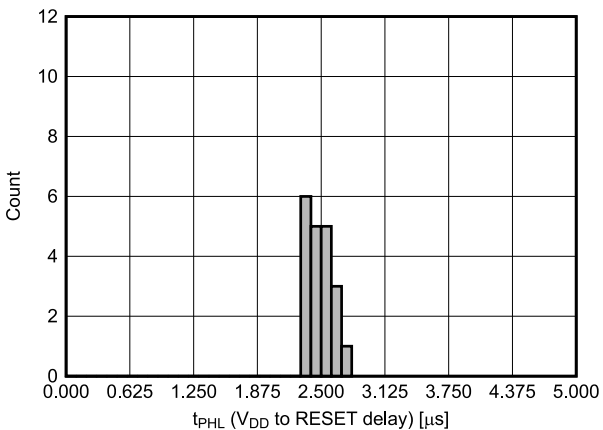
**Figure 7-16. MR to RESET ( $t_{PHL}$ ) Delay Histogram for TPS3705-33 Devices at 25°C (Unit Count = 20)**



**Figure 7-17. MR to RESET ( $t_{PHL}$ ) Delay Histogram for TPS3705-33 Devices at 125°C (Unit Count = 20)**

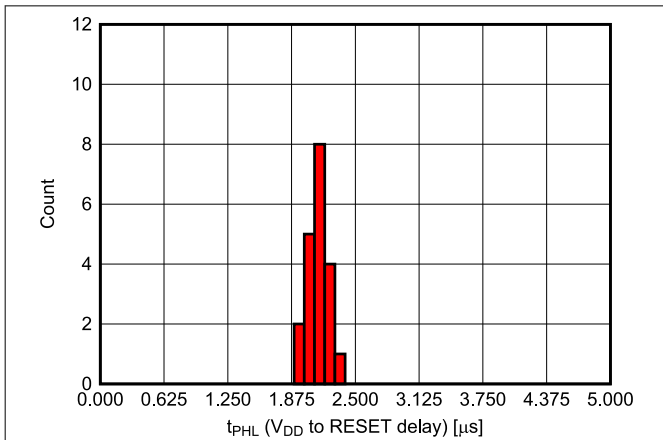


**Figure 7-18. V<sub>DD</sub> to RESET ( $t_{PHL}$ ) Delay Histogram for TPS3705-33 Devices at -40°C (Unit Count = 20)**

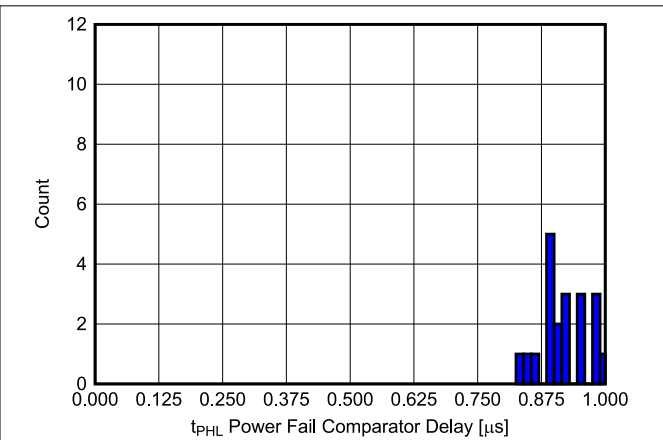


**Figure 7-19. V<sub>DD</sub> to RESET ( $t_{PHL}$ ) Delay Histogram for TPS3705-33 Devices at 25°C (Unit Count = 20)**

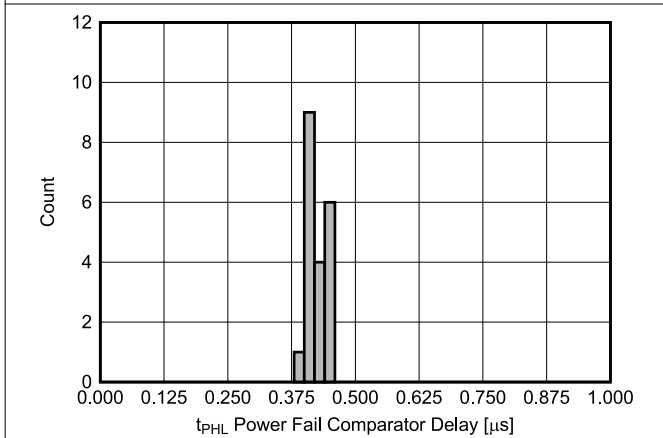
### 7.11 Typical Characteristics (continued)



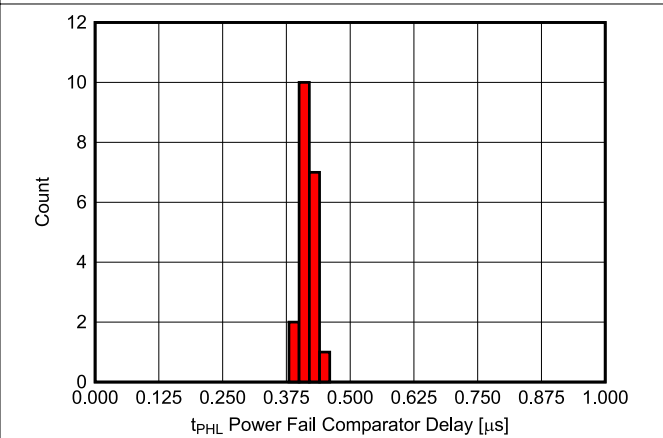
**Figure 7-20. V<sub>DD</sub> to RESET ( $t_{PHL}$ ) Delay Histogram for TPS3705-33 Devices at 125°C (Unit Count = 20)**



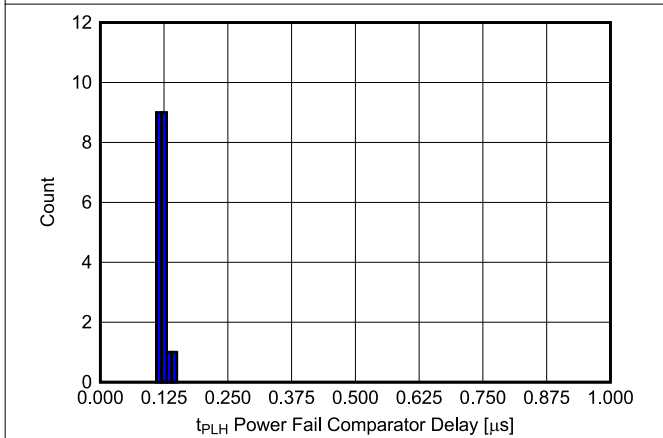
**Figure 7-21. PFI to PFO ( $t_{PHL}$ ) Delay Histogram for TPS3705-33 Devices at -40°C (Unit Count = 20)**



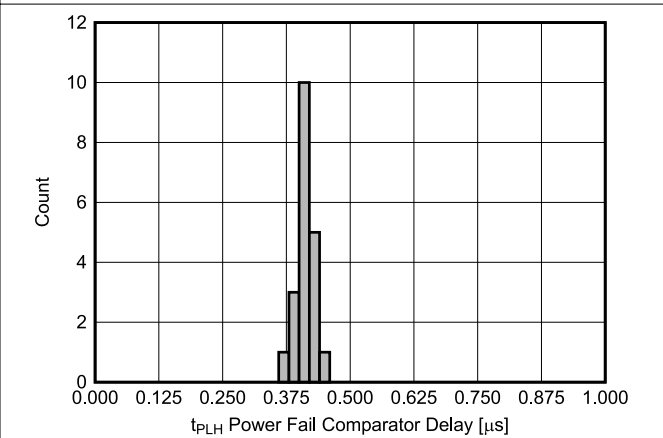
**Figure 7-22. PFI to PFO ( $t_{PHL}$ ) Delay Histogram for TPS3705-33 Devices at 25°C (Unit Count = 20)**



**Figure 7-23. PFI to PFO ( $t_{PHL}$ ) Delay Histogram for TPS3705-33 Devices at 125°C (Unit Count = 20)**



**Figure 7-24. PFI to PFO ( $t_{PLH}$ ) Delay Histogram for TPS3705-33 Devices at -40°C (Unit Count = 20)**



**Figure 7-25. PFI to PFO ( $t_{PLH}$ ) Delay Histogram for TPS3705-33 Devices at 25°C (Unit Count = 20)**

### 7.11 Typical Characteristics (continued)

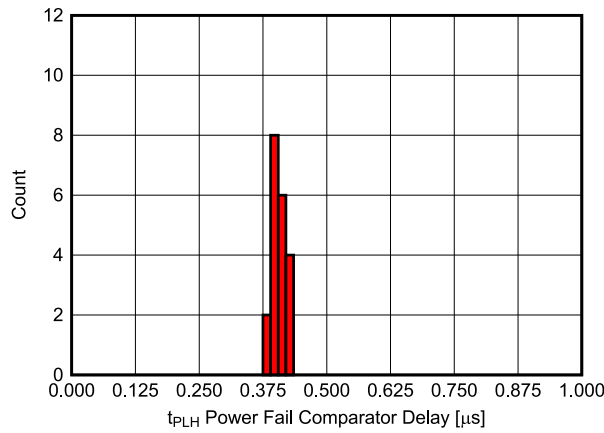


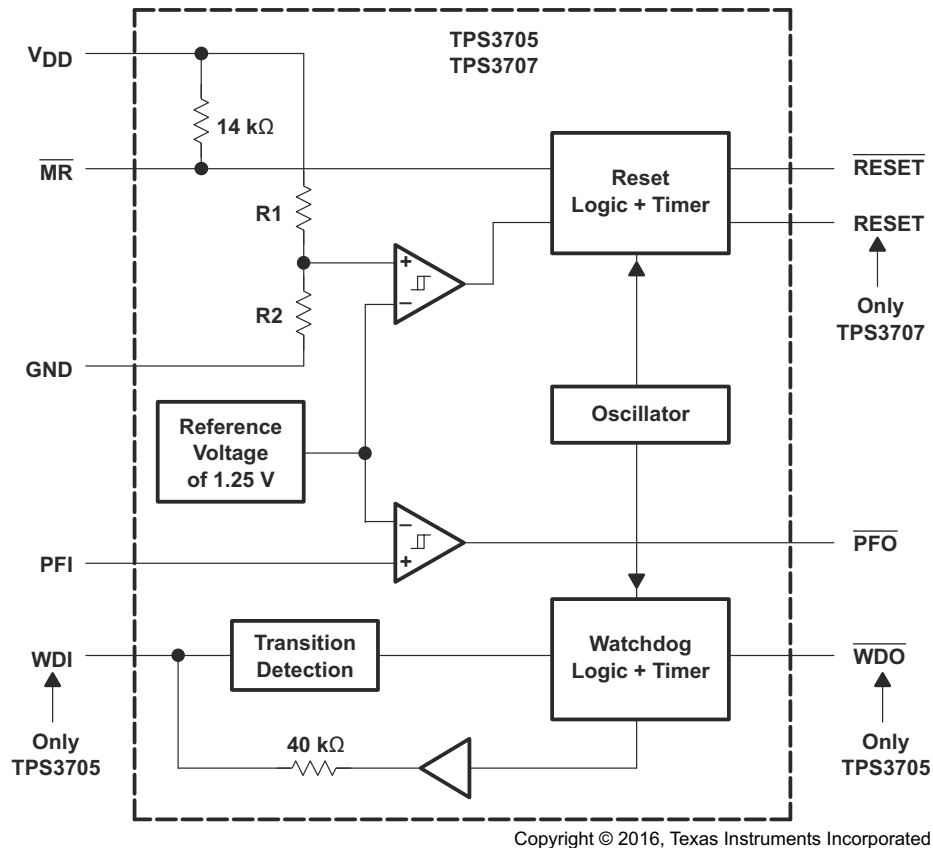
Figure 7-26. PFI to  $\overline{PFO}$  ( $t_{PLH}$ ) Delay Histogram for TPS3705-33 Devices at 125°C (Unit Count = 20)

## 8 Detailed Description

### 8.1 Overview

The TPS370x-xx family of supervisors feature an integrated reference and comparator for  $V_{DD}$  supervision, an additional power-fail supervisor, and a manual reset input. The TPS3705-xx devices feature a watchdog timer, where the TPS3707-xx devices feature a complimentary RESET output.

### 8.2 Functional Block Diagram



### 8.3 Feature Description

#### 8.3.1 Manual Reset Input

The TPS370x-xx devices incorporate a manual reset input,  $\overline{MR}$ . A low level at  $\overline{MR}$  causes  $\overline{RESET}$  to become active.

#### 8.3.2 Power-Fail Comparator

The TPS370x-xx family integrates a power-fail comparator which can be used for low-battery detection, power-fail warning, or for monitoring a power supply other than the main supply.

#### 8.3.3 Watchdog Timer

The TPS3705-xx devices have a watchdog timer that is periodically triggered by a positive or negative transition at WDI. When the supervising system fails to retrigger the watchdog circuit within the timeout interval,  $t_{t(out)} = 1.6$  s,  $\overline{WDO}$  becomes active. This event also reinitializes the watchdog timer. Leaving WDI unconnected disables the watchdog.

The TPS3707-xx devices do not have the watchdog function, but include a high-level output RESET.



## 8.4 Device Functional Modes

### 8.4.1 $V_{DD} < 1.1\text{ V}$

When  $V_{DD}$  is less than 1.1 V, the status of the outputs cannot be determined.

### 8.4.2 $1.1\text{ V} < V_{DD} \leq 2\text{ V}$

When  $V_{DD}$  is greater than 1.1 V but less than 2 V, the output states are valid. However, the specifications in [Section 7.5](#) do not apply.

### 8.4.3 $2\text{ V} < V_{DD} < 6\text{ V}$

When  $V_{DD}$  is greater than 2 V but less than 6 V, the device is within the recommended operating conditions (see [Section 7.3](#)). See [Table 8-1](#), [Table 8-2](#), and [Table 8-3](#) for corresponding truth tables.

**Table 8-1. TPS3705 Truth Table**

$\overline{\text{MR}}$	$V_{DD} > V_{IT}$	RESET	TYPICAL DELAY
H → L	1	H → L	30 ns
L → H	1	L → H	200 ms
H	1 → 0	H → L	3 $\mu\text{s}$
H	0 → 1	L → H	200 ms

**Table 8-2. TPS3707 Truth Table**

$\overline{\text{MR}}$	$V_{DD} > V_{IT}$	$\overline{\text{RESET}}$	RESET	TYPICAL DELAY
H → L	1	H → L	L → H	30 ns
L → H	1	L → H	H → L	200 ms
H	1 → 0	H → L	L → H	3 $\mu\text{s}$
H	0 → 1	L → H	H → L	200 ms

**Table 8-3. TPS370x Truth Table**

$\text{PFI} > V_{IT}$	PFO	TYPICAL DELAY
0 → 1	L → H	0.5 $\mu\text{s}$
1 → 0	H → L	0.5 $\mu\text{s}$

## 9 Application and Implementation

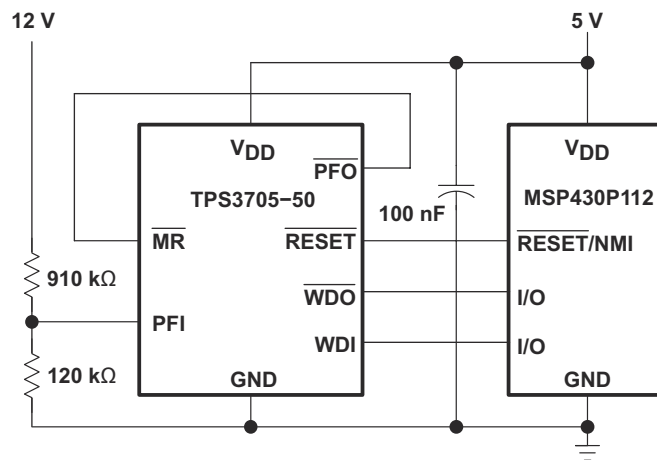
### Note

Information in the following applications sections is not part of the TI component specification, and TI does not warrant its accuracy or completeness. TI's customers are responsible for determining suitability of components for their purposes. Customers should validate and test their design implementation to confirm system functionality.

### 9.1 Application Information

The TPS370x-xx family of devices offers several options for power monitoring. The TPS3705-xx offers a watchdog supervisor,  $V_{DD}$  rail monitoring, and a power-fail interrupt monitor. The TPS3707-xx offers  $V_{DD}$  rail monitoring with complimentary outputs and a power-fail interrupt monitor.

### 9.2 Typical Application



Copyright © 2016, Texas Instruments Incorporated

**Figure 9-1. Typical MSP430 Application**

#### 9.2.1 Design Requirements

Table 9-1 lists the required design parameters for Figure 9-1.

**Table 9-1. Application Parameters**

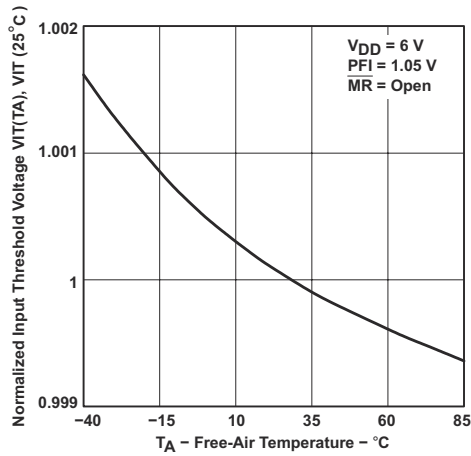
DESIGN PARAMETER	VALUE
Monitored voltage 1	5 V
Monitored voltage 2	12 V

#### 9.2.2 Detailed Design Procedure

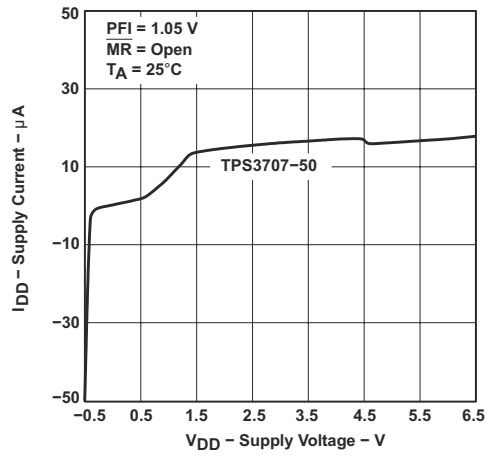
To create two voltage monitoring rails, the PFI input can be used along with the MR pin to create a single output. The 5-V monitor is created by selecting a 5-V device option, giving threshold of 4.55 V. The PFI input is configured to any adjustable rail with a voltage divider. Use Equation 1 to select resistors.

$$V_{TH} = \frac{R_1 + R_2}{R_2} \times V_{IT-} = \frac{910 \text{ k} + 120 \text{ k}}{120 \text{ k}} \times 1.25 = 10.73 \text{ V} \quad (1)$$

### 9.2.3 Application Curves



**Figure 9-2. Normalized Input Threshold Voltage vs Free-Air Temperature at V<sub>DD</sub>**



**Figure 9-3. Supply Current vs Supply Voltage**

## 10 Power Supply Recommendations

These devices are designed to operate from an input supply with a voltage range from 2 V to 6 V.

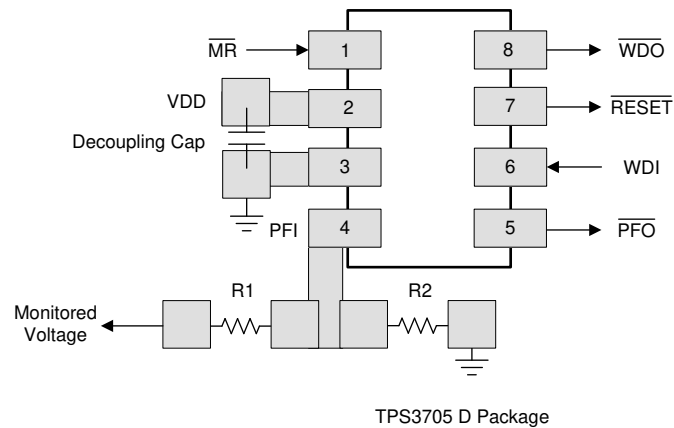
## 11 Layout

### 11.1 Layout Guidelines

Place a 0.1- $\mu$ F decoupling capacitor as close to the device as possible.

If a resistor divider is used, place the resistors as close to the device as possible to minimize noise coupling.

### 11.2 Layout Example



**Figure 11-1. TPS3705 Layout**

## 12 Device and Documentation Support

### 12.1 Receiving Notification of Documentation Updates

To receive notification of documentation updates, navigate to the device product folder on [ti.com](http://ti.com). Click on *Subscribe to updates* to register and receive a weekly digest of any product information that has changed. For change details, review the revision history included in any revised document.

### 12.2 Support Resources

[TI E2E™ support forums](#) are an engineer's go-to source for fast, verified answers and design help — straight from the experts. Search existing answers or ask your own question to get the quick design help you need.

Linked content is provided "AS IS" by the respective contributors. They do not constitute TI specifications and do not necessarily reflect TI's views; see TI's [Terms of Use](#).

### 12.3 Trademarks

PowerPAD™ and TI E2E™ are trademarks of Texas Instruments. All other trademarks are the property of their respective owners.

### 12.4 Electrostatic Discharge Caution



This integrated circuit can be damaged by ESD. Texas Instruments recommends that all integrated circuits be handled with appropriate precautions. Failure to observe proper handling and installation procedures can cause damage.

ESD damage can range from subtle performance degradation to complete device failure. Precision integrated circuits may be more susceptible to damage because very small parametric changes could cause the device not to meet its published specifications.

### 12.5 Glossary

[TI Glossary](#) This glossary lists and explains terms, acronyms, and definitions.

## 13 Mechanical, Packaging, and Orderable Information

The following pages include mechanical, packaging, and orderable information. This information is the most current data available for the designated devices. This data is subject to change without notice and revision of this document. For browser-based versions of this data sheet, refer to the left-hand navigation.

**PACKAGING INFORMATION**

Orderable Device	Status (1)	Package Type	Package Drawing	Pins	Package Qty	Eco Plan (2)	Lead finish/ Ball material (6)	MSL Peak Temp (3)	Op Temp (°C)	Device Marking (4/5)	Samples
TPS3705-30D	ACTIVE	SOIC	D	8	75	RoHS & Green	NIPDAU	Level-1-260C-UNLIM	-40 to 85	70530	<a href="#">Samples</a>
TPS3705-30DGN	ACTIVE	HVSSOP	DGN	8	80	RoHS & Green	NIPDAU	Level-1-260C-UNLIM	-40 to 85	AAT	<a href="#">Samples</a>
TPS3705-30DR	ACTIVE	SOIC	D	8	2500	RoHS & Green	NIPDAU	Level-1-260C-UNLIM	-40 to 85	70530	<a href="#">Samples</a>
TPS3705-33D	ACTIVE	SOIC	D	8	75	RoHS & Green	NIPDAU	Level-1-260C-UNLIM	-40 to 125	70533	<a href="#">Samples</a>
TPS3705-33DG4	ACTIVE	SOIC	D	8	75	RoHS & Green	NIPDAU	Level-1-260C-UNLIM	-40 to 125	70533	<a href="#">Samples</a>
TPS3705-33DGN	ACTIVE	HVSSOP	DGN	8	80	RoHS & Green	NIPDAU	Level-1-260C-UNLIM	-40 to 85	AAU	<a href="#">Samples</a>
TPS3705-33DGNR	ACTIVE	HVSSOP	DGN	8	2500	RoHS & Green	NIPDAU	Level-1-260C-UNLIM	-40 to 85	AAU	<a href="#">Samples</a>
TPS3705-33DR	ACTIVE	SOIC	D	8	2500	RoHS & Green	NIPDAU	Level-1-260C-UNLIM	-40 to 125	70533	<a href="#">Samples</a>
TPS3705-33DRG4	ACTIVE	SOIC	D	8	2500	RoHS & Green	NIPDAU	Level-1-260C-UNLIM	-40 to 125	70533	<a href="#">Samples</a>
TPS3705-50D	ACTIVE	SOIC	D	8	75	RoHS & Green	NIPDAU	Level-1-260C-UNLIM	-40 to 85	70550	<a href="#">Samples</a>
TPS3705-50DG4	ACTIVE	SOIC	D	8	75	RoHS & Green	NIPDAU	Level-1-260C-UNLIM	-40 to 85	70550	<a href="#">Samples</a>
TPS3705-50DGN	ACTIVE	HVSSOP	DGN	8	80	RoHS & Green	NIPDAU	Level-1-260C-UNLIM	-40 to 85	AAV	<a href="#">Samples</a>
TPS3705-50DGN4	ACTIVE	HVSSOP	DGN	8	80	RoHS & Green	NIPDAU	Level-1-260C-UNLIM	-40 to 85	AAV	<a href="#">Samples</a>
TPS3705-50DGNR	ACTIVE	HVSSOP	DGN	8	2500	RoHS & Green	NIPDAU	Level-1-260C-UNLIM	-40 to 85	AAV	<a href="#">Samples</a>
TPS3705-50DR	ACTIVE	SOIC	D	8	2500	RoHS & Green	NIPDAU	Level-1-260C-UNLIM	-40 to 85	70550	<a href="#">Samples</a>
TPS3705-50DRG4	ACTIVE	SOIC	D	8	2500	RoHS & Green	NIPDAU	Level-1-260C-UNLIM	-40 to 85	70550	<a href="#">Samples</a>
TPS3707-25D	ACTIVE	SOIC	D	8	75	RoHS & Green	NIPDAU	Level-1-260C-UNLIM	-40 to 85	70725	<a href="#">Samples</a>
TPS3707-25DG4	ACTIVE	SOIC	D	8	75	RoHS & Green	NIPDAU	Level-1-260C-UNLIM	-40 to 85	70725	<a href="#">Samples</a>
TPS3707-25DGN	ACTIVE	HVSSOP	DGN	8	80	RoHS & Green	NIPDAU	Level-1-260C-UNLIM	-40 to 85	AAW	<a href="#">Samples</a>
TPS3707-25DGNR	ACTIVE	HVSSOP	DGN	8	2500	RoHS & Green	NIPDAU	Level-1-260C-UNLIM	-40 to 85	AAW	<a href="#">Samples</a>

Orderable Device	Status (1)	Package Type	Package Drawing	Pins	Package Qty	Eco Plan (2)	Lead finish/ Ball material (6)	MSL Peak Temp (3)	Op Temp (°C)	Device Marking (4/5)	Samples
TPS3707-25DGNRG4	ACTIVE	HVSSOP	DGN	8	2500	RoHS & Green	NIPDAU	Level-1-260C-UNLIM	-40 to 85	AAW	<a href="#">Samples</a>
TPS3707-25DR	ACTIVE	SOIC	D	8	2500	RoHS & Green	NIPDAU	Level-1-260C-UNLIM	-40 to 85	70725	<a href="#">Samples</a>
TPS3707-30D	ACTIVE	SOIC	D	8	75	RoHS & Green	NIPDAU	Level-1-260C-UNLIM	-40 to 85	70730	<a href="#">Samples</a>
TPS3707-30DG4	ACTIVE	SOIC	D	8	75	RoHS & Green	NIPDAU	Level-1-260C-UNLIM	-40 to 85	70730	<a href="#">Samples</a>
TPS3707-30DGN	ACTIVE	HVSSOP	DGN	8	80	RoHS & Green	NIPDAU	Level-1-260C-UNLIM	-40 to 85	AAX	<a href="#">Samples</a>
TPS3707-30DGNR	ACTIVE	HVSSOP	DGN	8	2500	RoHS & Green	NIPDAU	Level-1-260C-UNLIM	-40 to 85	AAX	<a href="#">Samples</a>
TPS3707-30DR	ACTIVE	SOIC	D	8	2500	RoHS & Green	NIPDAU	Level-1-260C-UNLIM	-40 to 85	70730	<a href="#">Samples</a>
TPS3707-33D	ACTIVE	SOIC	D	8	75	RoHS & Green	NIPDAU	Level-1-260C-UNLIM	-40 to 85	70733	<a href="#">Samples</a>
TPS3707-33DG4	ACTIVE	SOIC	D	8	75	RoHS & Green	NIPDAU	Level-1-260C-UNLIM	-40 to 85	70733	<a href="#">Samples</a>
TPS3707-33DGN	ACTIVE	HVSSOP	DGN	8	80	RoHS & Green	NIPDAU	Level-1-260C-UNLIM	-40 to 85	AAZ	<a href="#">Samples</a>
TPS3707-33DGNG4	ACTIVE	HVSSOP	DGN	8	80	RoHS & Green	NIPDAU	Level-1-260C-UNLIM	-40 to 85	AAZ	<a href="#">Samples</a>
TPS3707-33DGNR	ACTIVE	HVSSOP	DGN	8	2500	RoHS & Green	NIPDAU	Level-1-260C-UNLIM	-40 to 85	AAZ	<a href="#">Samples</a>
TPS3707-33DGNRG4	ACTIVE	HVSSOP	DGN	8	2500	RoHS & Green	NIPDAU	Level-1-260C-UNLIM	-40 to 85	AAZ	<a href="#">Samples</a>
TPS3707-33DR	ACTIVE	SOIC	D	8	2500	RoHS & Green	NIPDAU	Level-1-260C-UNLIM	-40 to 85	70733	<a href="#">Samples</a>
TPS3707-50D	ACTIVE	SOIC	D	8	75	RoHS & Green	NIPDAU	Level-1-260C-UNLIM	-40 to 85	70750	<a href="#">Samples</a>
TPS3707-50DGN	ACTIVE	HVSSOP	DGN	8	80	RoHS & Green	NIPDAU	Level-1-260C-UNLIM	-40 to 85	AAZ	<a href="#">Samples</a>
TPS3707-50DGNG4	ACTIVE	HVSSOP	DGN	8	80	RoHS & Green	NIPDAU	Level-1-260C-UNLIM	-40 to 85	AAZ	<a href="#">Samples</a>
TPS3707-50DGNR	ACTIVE	HVSSOP	DGN	8	2500	RoHS & Green	NIPDAU	Level-1-260C-UNLIM	-40 to 85	AAZ	<a href="#">Samples</a>
TPS3707-50DR	ACTIVE	SOIC	D	8	2500	RoHS & Green	NIPDAU	Level-1-260C-UNLIM	-40 to 85	70750	<a href="#">Samples</a>

(1) The marketing status values are defined as follows:

**ACTIVE:** Product device recommended for new designs.

**LIFEBUY:** TI has announced that the device will be discontinued, and a lifetime-buy period is in effect.

**NRND:** Not recommended for new designs. Device is in production to support existing customers, but TI does not recommend using this part in a new design.

**PREVIEW:** Device has been announced but is not in production. Samples may or may not be available.

**OBSOLETE:** TI has discontinued the production of the device.

<sup>(2)</sup> **RoHS:** TI defines "RoHS" to mean semiconductor products that are compliant with the current EU RoHS requirements for all 10 RoHS substances, including the requirement that RoHS substance do not exceed 0.1% by weight in homogeneous materials. Where designed to be soldered at high temperatures, "RoHS" products are suitable for use in specified lead-free processes. TI may reference these types of products as "Pb-Free".

**RoHS Exempt:** TI defines "RoHS Exempt" to mean products that contain lead but are compliant with EU RoHS pursuant to a specific EU RoHS exemption.

**Green:** TI defines "Green" to mean the content of Chlorine (Cl) and Bromine (Br) based flame retardants meet JS709B low halogen requirements of  $\leq 1000$ ppm threshold. Antimony trioxide based flame retardants must also meet the  $\leq 1000$ ppm threshold requirement.

<sup>(3)</sup> **MSL, Peak Temp.** - The Moisture Sensitivity Level rating according to the JEDEC industry standard classifications, and peak solder temperature.

<sup>(4)</sup> There may be additional marking, which relates to the logo, the lot trace code information, or the environmental category on the device.

<sup>(5)</sup> Multiple Device Markings will be inside parentheses. Only one Device Marking contained in parentheses and separated by a "~" will appear on a device. If a line is indented then it is a continuation of the previous line and the two combined represent the entire Device Marking for that device.

<sup>(6)</sup> **Lead finish/Ball material** - Orderable Devices may have multiple material finish options. Finish options are separated by a vertical ruled line. Lead finish/Ball material values may wrap to two lines if the finish value exceeds the maximum column width.

**Important Information and Disclaimer:** The information provided on this page represents TI's knowledge and belief as of the date that it is provided. TI bases its knowledge and belief on information provided by third parties, and makes no representation or warranty as to the accuracy of such information. Efforts are underway to better integrate information from third parties. TI has taken and continues to take reasonable steps to provide representative and accurate information but may not have conducted destructive testing or chemical analysis on incoming materials and chemicals. TI and TI suppliers consider certain information to be proprietary, and thus CAS numbers and other limited information may not be available for release.

In no event shall TI's liability arising out of such information exceed the total purchase price of the TI part(s) at issue in this document sold by TI to Customer on an annual basis.



**TAPE AND REEL INFORMATION**

**QUADRANT ASSIGNMENTS FOR PIN 1 ORIENTATION IN TAPE**

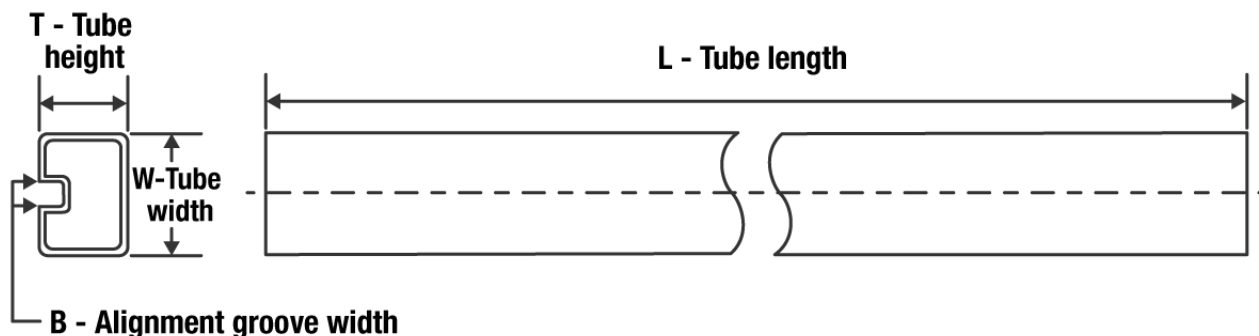

\*All dimensions are nominal

Device	Package Type	Package Drawing	Pins	SPQ	Reel Diameter (mm)	Reel Width W1 (mm)	A0 (mm)	B0 (mm)	K0 (mm)	P1 (mm)	W (mm)	Pin1 Quadrant
TPS3705-30DR	SOIC	D	8	2500	330.0	12.4	6.4	5.2	2.1	8.0	12.0	Q1
TPS3705-33DGNR	HVSSOP	DGN	8	2500	330.0	12.4	5.3	3.4	1.4	8.0	12.0	Q1
TPS3705-33DR	SOIC	D	8	2500	330.0	12.4	6.4	5.2	2.1	8.0	12.0	Q1
TPS3705-50DGNR	HVSSOP	DGN	8	2500	330.0	12.4	5.3	3.4	1.4	8.0	12.0	Q1
TPS3705-50DR	SOIC	D	8	2500	330.0	12.4	6.4	5.2	2.1	8.0	12.0	Q1
TPS3707-25DGNR	HVSSOP	DGN	8	2500	330.0	12.4	5.3	3.4	1.4	8.0	12.0	Q1
TPS3707-25DR	SOIC	D	8	2500	330.0	12.4	6.4	5.2	2.1	8.0	12.0	Q1
TPS3707-30DGNR	HVSSOP	DGN	8	2500	330.0	12.4	5.3	3.4	1.4	8.0	12.0	Q1
TPS3707-30DR	SOIC	D	8	2500	330.0	12.4	6.4	5.2	2.1	8.0	12.0	Q1
TPS3707-33DGNR	HVSSOP	DGN	8	2500	330.0	12.4	5.3	3.4	1.4	8.0	12.0	Q1
TPS3707-33DR	SOIC	D	8	2500	330.0	12.4	6.4	5.2	2.1	8.0	12.0	Q1
TPS3707-50DGNR	HVSSOP	DGN	8	2500	330.0	12.4	5.3	3.4	1.4	8.0	12.0	Q1
TPS3707-50DR	SOIC	D	8	2500	330.0	12.4	6.4	5.2	2.1	8.0	12.0	Q1

**TAPE AND REEL BOX DIMENSIONS**


\*All dimensions are nominal

Device	Package Type	Package Drawing	Pins	SPQ	Length (mm)	Width (mm)	Height (mm)
TPS3705-30DR	SOIC	D	8	2500	350.0	350.0	43.0
TPS3705-33DGNR	HVSSOP	DGN	8	2500	358.0	335.0	35.0
TPS3705-33DR	SOIC	D	8	2500	350.0	350.0	43.0
TPS3705-50DGNR	HVSSOP	DGN	8	2500	358.0	335.0	35.0
TPS3705-50DR	SOIC	D	8	2500	350.0	350.0	43.0
TPS3707-25DGNR	HVSSOP	DGN	8	2500	358.0	335.0	35.0
TPS3707-25DR	SOIC	D	8	2500	350.0	350.0	43.0
TPS3707-30DGNR	HVSSOP	DGN	8	2500	358.0	335.0	35.0
TPS3707-30DR	SOIC	D	8	2500	853.0	449.0	35.0
TPS3707-33DGNR	HVSSOP	DGN	8	2500	358.0	335.0	35.0
TPS3707-33DR	SOIC	D	8	2500	350.0	350.0	43.0
TPS3707-50DGNR	HVSSOP	DGN	8	2500	358.0	335.0	35.0
TPS3707-50DR	SOIC	D	8	2500	350.0	350.0	43.0

**TUBE**


\*All dimensions are nominal

Device	Package Name	Package Type	Pins	SPQ	L (mm)	W (mm)	T (μm)	B (mm)
TPS3705-30D	D	SOIC	8	75	505.46	6.76	3810	4
TPS3705-30D	D	SOIC	8	75	506.6	8	3940	4.32
TPS3705-33D	D	SOIC	8	75	505.46	6.76	3810	4
TPS3705-33DG4	D	SOIC	8	75	505.46	6.76	3810	4
TPS3705-50D	D	SOIC	8	75	505.46	6.76	3810	4
TPS3705-50DG4	D	SOIC	8	75	505.46	6.76	3810	4
TPS3707-25D	D	SOIC	8	75	505.46	6.76	3810	4
TPS3707-25DG4	D	SOIC	8	75	505.46	6.76	3810	4
TPS3707-30D	D	SOIC	8	75	505.46	6.76	3810	4
TPS3707-30D	D	SOIC	8	75	506.6	8	3940	4.32
TPS3707-30DG4	D	SOIC	8	75	505.46	6.76	3810	4
TPS3707-30DG4	D	SOIC	8	75	506.6	8	3940	4.32
TPS3707-33D	D	SOIC	8	75	505.46	6.76	3810	4
TPS3707-33DG4	D	SOIC	8	75	505.46	6.76	3810	4
TPS3707-50D	D	SOIC	8	75	505.46	6.76	3810	4

## GENERIC PACKAGE VIEW

**DGN 8**

**PowerPAD VSSOP - 1.1 mm max height**

3 x 3, 0.65 mm pitch

SMALL OUTLINE PACKAGE

This image is a representation of the package family, actual package may vary.  
Refer to the product data sheet for package details.



4225482/A



4225481/A 11/2019

NOTES:

PowerPAD is a trademark of Texas Instruments.

1. All linear dimensions are in millimeters. Any dimensions in parenthesis are for reference only. Dimensioning and tolerancing per ASME Y14.5M.
2. This drawing is subject to change without notice.
3. This dimension does not include mold flash, protrusions, or gate burrs. Mold flash, protrusions, or gate burrs shall not exceed 0.15 mm per side.
4. This dimension does not include interlead flash. Interlead flash shall not exceed 0.25 mm per side.
5. Reference JEDEC registration MO-187.

# EXAMPLE BOARD LAYOUT

DGN0008D

PowerPAD™ VSSOP - 1.1 mm max height

SMALL OUTLINE PACKAGE



LAND PATTERN EXAMPLE  
EXPOSED METAL SHOWN  
SCALE: 15X



SOLDER MASK DETAILS

4225481/A 11/2019

NOTES: (continued)

6. Publication IPC-7351 may have alternate designs.
7. Solder mask tolerances between and around signal pads can vary based on board fabrication site.
8. Vias are optional depending on application, refer to device data sheet. If any vias are implemented, refer to their locations shown on this view. It is recommended that vias under paste be filled, plugged or tented.
9. Size of metal pad may vary due to creepage requirement.

# EXAMPLE STENCIL DESIGN

DGN0008D

PowerPAD™ VSSOP - 1.1 mm max height

SMALL OUTLINE PACKAGE



**SOLDER PASTE EXAMPLE**  
EXPOSED PAD 9:  
100% PRINTED SOLDER COVERAGE BY AREA  
SCALE: 15X

STENCIL THICKNESS	SOLDER STENCIL OPENING
0.1	1.76 X 2.11
0.125	1.57 X 1.89 (SHOWN)
0.15	1.43 X 1.73
0.175	1.33 X 1.60

4225481/A 11/2019

NOTES: (continued)

10. Laser cutting apertures with trapezoidal walls and rounded corners may offer better paste release. IPC-7525 may have alternate design recommendations.
11. Board assembly site may have different recommendations for stencil design.



D0008A

# PACKAGE OUTLINE

SOIC - 1.75 mm max height

SMALL OUTLINE INTEGRATED CIRCUIT



4214825/C 02/2019

### NOTES:

- Linear dimensions are in inches [millimeters]. Dimensions in parenthesis are for reference only. Controlling dimensions are in inches. Dimensioning and tolerancing per ASME Y14.5M.
- This drawing is subject to change without notice.
- This dimension does not include mold flash, protrusions, or gate burrs. Mold flash, protrusions, or gate burrs shall not exceed  $.006$  [0.15] per side.
- This dimension does not include interlead flash.
- Reference JEDEC registration MS-012, variation AA.



# EXAMPLE BOARD LAYOUT

D0008A

SOIC - 1.75 mm max height

SMALL OUTLINE INTEGRATED CIRCUIT



LAND PATTERN EXAMPLE  
 EXPOSED METAL SHOWN  
 SCALE:8X



SOLDER MASK DETAILS

4214825/C 02/2019

NOTES: (continued)

- 6. Publication IPC-7351 may have alternate designs.
- 7. Solder mask tolerances between and around signal pads can vary based on board fabrication site.

# EXAMPLE STENCIL DESIGN

D0008A

SOIC - 1.75 mm max height

SMALL OUTLINE INTEGRATED CIRCUIT



SOLDER PASTE EXAMPLE  
BASED ON .005 INCH [0.125 MM] THICK STENCIL  
SCALE:8X

4214825/C 02/2019

NOTES: (continued)

8. Laser cutting apertures with trapezoidal walls and rounded corners may offer better paste release. IPC-7525 may have alternate design recommendations.
9. Board assembly site may have different recommendations for stencil design.

## IMPORTANT NOTICE AND DISCLAIMER

TI PROVIDES TECHNICAL AND RELIABILITY DATA (INCLUDING DATA SHEETS), DESIGN RESOURCES (INCLUDING REFERENCE DESIGNS), APPLICATION OR OTHER DESIGN ADVICE, WEB TOOLS, SAFETY INFORMATION, AND OTHER RESOURCES "AS IS" AND WITH ALL FAULTS, AND DISCLAIMS ALL WARRANTIES, EXPRESS AND IMPLIED, INCLUDING WITHOUT LIMITATION ANY IMPLIED WARRANTIES OF MERCHANTABILITY, FITNESS FOR A PARTICULAR PURPOSE OR NON-INFRINGEMENT OF THIRD PARTY INTELLECTUAL PROPERTY RIGHTS.

These resources are intended for skilled developers designing with TI products. You are solely responsible for (1) selecting the appropriate TI products for your application, (2) designing, validating and testing your application, and (3) ensuring your application meets applicable standards, and any other safety, security, regulatory or other requirements.

These resources are subject to change without notice. TI grants you permission to use these resources only for development of an application that uses the TI products described in the resource. Other reproduction and display of these resources is prohibited. No license is granted to any other TI intellectual property right or to any third party intellectual property right. TI disclaims responsibility for, and you will fully indemnify TI and its representatives against, any claims, damages, costs, losses, and liabilities arising out of your use of these resources.

TI's products are provided subject to [TI's Terms of Sale](#) or other applicable terms available either on [ti.com](http://ti.com) or provided in conjunction with such TI products. TI's provision of these resources does not expand or otherwise alter TI's applicable warranties or warranty disclaimers for TI products.

TI objects to and rejects any additional or different terms you may have proposed.

Mailing Address: Texas Instruments, Post Office Box 655303, Dallas, Texas 75265  
Copyright © 2022, Texas Instruments Incorporated