

SDCL1V25

Semi-shielded power inductors

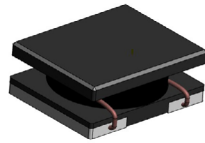

Product features

- High current carrying capacity
- High power density, low core losses
- Magnetically semi-shielded
- 2.8 mm x 2.35 mm surface mount package in 1.05 mm and 1.2 mm heights
- NiZn ferrite magnetic material
- Moisture sensitivity level (MSL): 1

Applications

- DC-DC converters
- Switching controllers
- Industrial IoT equipment
- Game consoles
- Portable electronics
- Laptops, notebooks, and netbooks
- Desktops and workstations
- Battery backup
- LED lighting
- HD televisions and displays

Environmental compliance and general specifications

- Storage temperature range (component): -40 °C to +125 °C
- Operating temperature range: -40 °C to +125 °C (ambient plus self-temperature rise)
- Solder reflow temperature: J-STD-020 (latest revision) compliant



Product specifications

Part number ⁵	OCL ¹ (μ H)	FLL ² (μ H) minimum	I_{RMS} ³ (A)	I_{SAT} ⁴ (A)	DCR (m Ω) @ +20 °C nominal	DCR (m Ω) @ +20 °C maximum
SDCL1V2510						
SDCL1V2510-R47N-R	0.47 \pm 30%	0.21	2.4	2.57	34	40
SDCL1V2510-R68N-R	0.68 \pm 30%	0.30	2.3	2.45	43	50
SDCL1V2510-1R0N-R	1.0 \pm 30%	0.46	1.9	2.4	61	70
SDCL1V2510-1R5N-R	1.5 \pm 30%	0.68	1.6	1.9	95	108
SDCL1V2510-2R2M-R	2.2 \pm 20%	1.14	1.4	1.6	130	150
SDCL1V2510-3R3M-R	3.3 \pm 20%	1.72	1.0	1.1	160	184
SDCL1V2510-4R7M-R	4.7 \pm 20%	2.44	0.9	1	220	253
SDCL1V2510-6R8M-R	6.8 \pm 20%	3.54	0.8	0.9	380	415
SDCL1V2510-100M-R	10 \pm 20%	5.2	0.6	0.7	495	575
SDCL1V2510-150M-R	15 \pm 20%	7.8	0.45	0.55	650	750
SDCL1V2512						
SDCL1V2512-R33N-R	0.33 \pm 30%	0.15	3.0	4.3	31	36
SDCL1V2512-R47N-R	0.47 \pm 30%	0.21	2.9	4.0	31	36
SDCL1V2512-R68N-R	0.68 \pm 30%	0.30	2.7	3.3	36	43
SDCL1V2512-1R0N-R	1.0 \pm 30%	0.46	2.4	2.8	49	55
SDCL1V2512-1R5N-R	1.5 \pm 30%	0.68	1.9	2.2	72	84
SDCL1V2512-2R2M-R	2.2 \pm 20%	1.14	1.7	1.9	92	106
SDCL1V2512-3R3M-R	3.3 \pm 20%	1.72	1.4	1.5	130	150
SDCL1V2512-4R7M-R	4.7 \pm 20%	2.44	1.1	1.35	205	236
SDCL1V2512-6R8M-R	6.8 \pm 20%	3.54	0.9	1.0	265	305
SDCL1V2512-100M-R	10 \pm 20%	5.2	0.7	0.8	400	460
SDCL1V2512-150M-R	15 \pm 20%	7.8	0.5	0.65	520	598
SDCL1V2512-220M-R	22 \pm 20%	11.44	0.4	0.55	860	990

1. Open circuit inductance (OCL) test parameters: 1.0 MHz, 0.1 Vrms, 0.0 Adc, +25 °C

2. Full load inductance (FLL) test parameters: 100 kHz, 0.1 Vrms, I_{SAT} , +25 °C

3. I_{RMS} : DC current for an approximate temperature rise of 40 °C without core loss. Derating is necessary for AC currents. PCB layout, trace thickness and width, air-flow, and proximity of other heat generating components will affect the temperature rise. It is recommended that the temperature of the part not exceed +125 °C under worst case operating conditions verified in the end application.

4. I_{SAT} : Peak current for approximately 35% maximum rolloff @ +25 °C

5. Part number definition: SDCL1Vxxxx-yyyz-R

SDCL1V = Product code

xxxx= size code

yyy= Inductance value in μ H, R=decimal point

z= Inductance tolerance

-R suffix = RoHS compliant

Dimensions-mm

SDCL1V2510

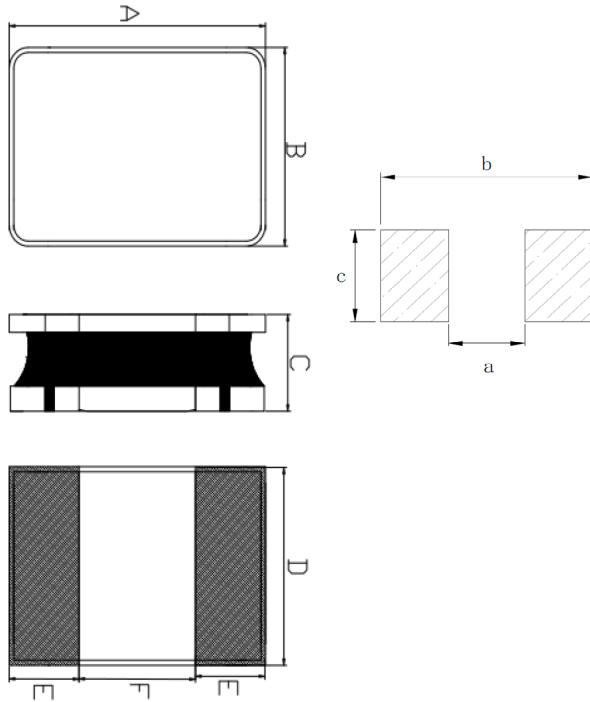

Dimension	Value
A	2.5 + 0.3/-0.1
B	2.0 + 0.35/-0.05
C	1.05 maximum
D	2.1 ± 0.2
E	0.825 ± 0.3
F	0.95 ± 0.3
a	0.65 TYP
b	2.8 TYP
c	2.4 TYP

SDCL1V2512

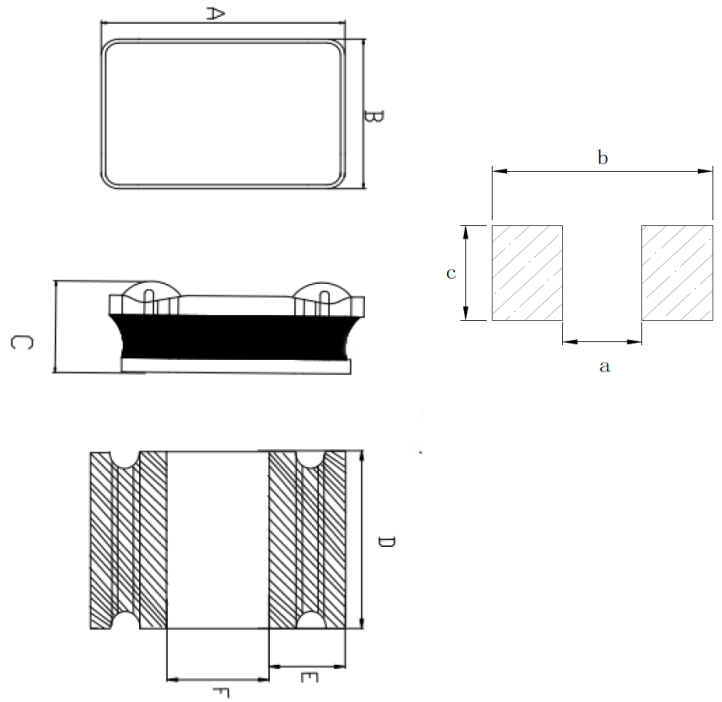

Dimension	Value
A	2.5 + 0.3/-0.1
B	2.0 + 0.35/-0.05
C	1.2 maximum
D	2.15 ± 0.2
E	0.8 ± 0.3
F	1.0 ± 0.3
a	0.7 TYP
b	2.8 TYP
c	2.45 TYP

Part marking: none
Tolerances are ±0.3 millimeters unless stated otherwise
All soldering surfaces to be coplanar within 0.1 millimeters
Pad layout tolerances are ±0.1 millimeters unless stated otherwise
Traces or vias underneath the inductor is not recommended

Packaging information- mm

SDCL1V2510

Supplied in tape and reel packaging, 2000 parts per 7" diameter reel (EIA-481 compliant)

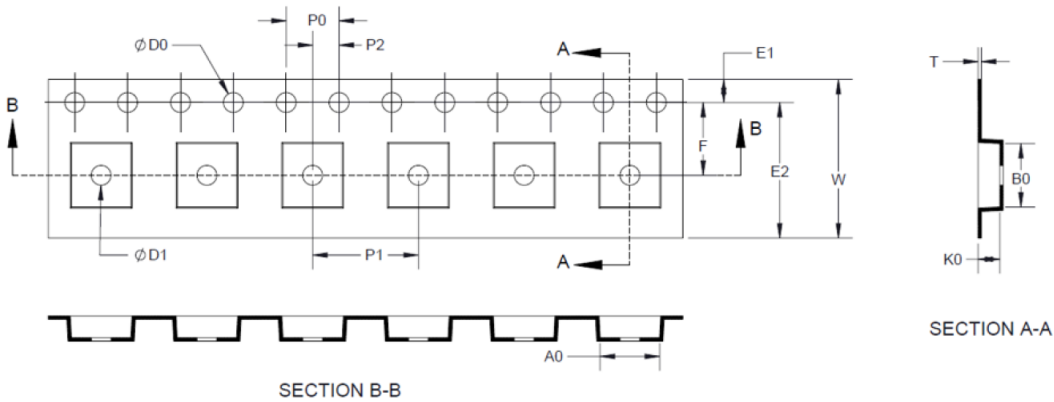

Dimension	Value
W	8.00 ± 0.10
F	3.50 ± 0.05
E1	1.75 ± 0.10
E2	N/A
P0	4.00 ± 0.10
P1	4.00 ± 0.10
P2	2.00 ± 0.10
$\phi D0$	1.55 ± 0.05
$\phi D1$	1.00 ± 0.05
A0	2.40 ± 0.1/-0.05
B0	3.00 ± 0.1/-0.05
K0	1.40 ± 0.1/-0.05
T	0.20 ± 0.05

Packaging information- mm

SDCL1V2512

Supplied in tape and reel packaging, 2000 parts per 7" diameter reel (EIA-481 compliant)

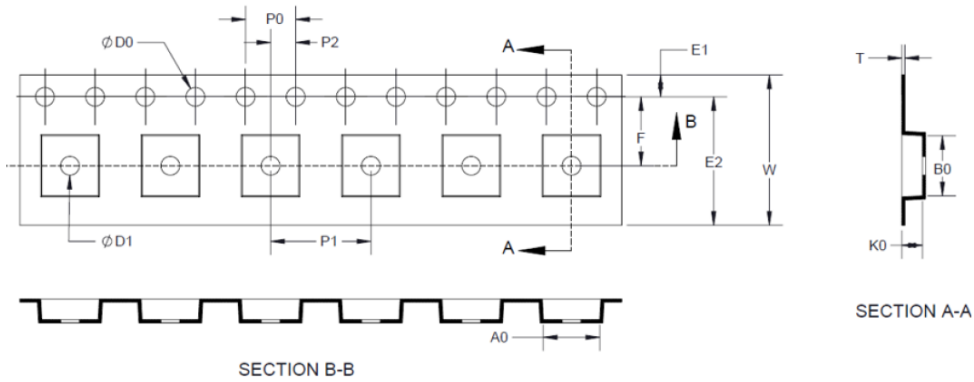

Dimension	Value
W	8.00 ± 0.10
F	3.50 ± 0.05
E1	1.75 ± 0.10
E2	N/A
P0	4.00 ± 0.10
P1	4.00 ± 0.10
P2	2.00 ± 0.10
$\phi D0$	1.55 ± 0.05
$\phi D1$	1.00 ± 0.05
A0	2.40 ± 0.1/-0.05
B0	3.00 ± 0.1/-0.05
K0	1.40 ± 0.1/-0.05
T	0.20 ± 0.05

Inductance and temperature rise vs current
SDCL1V2510

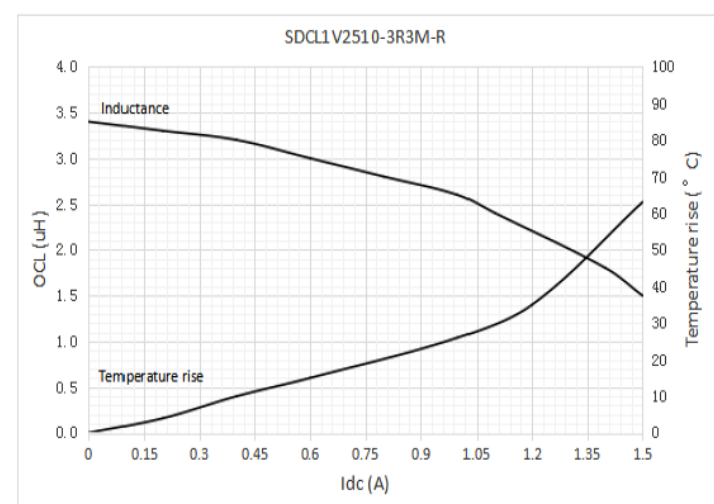
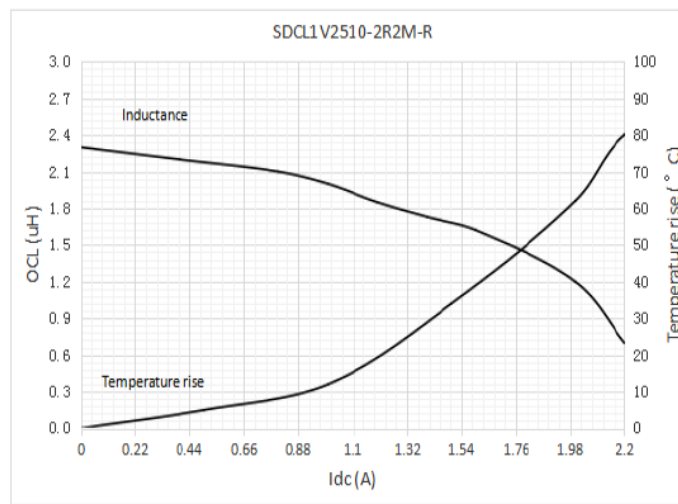
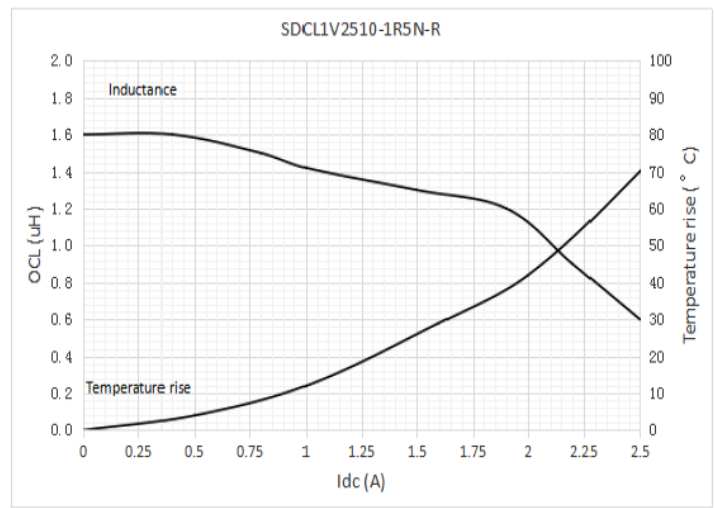
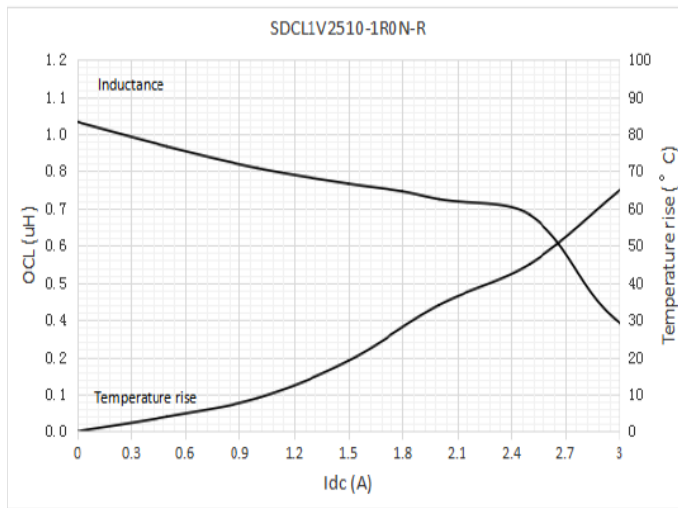
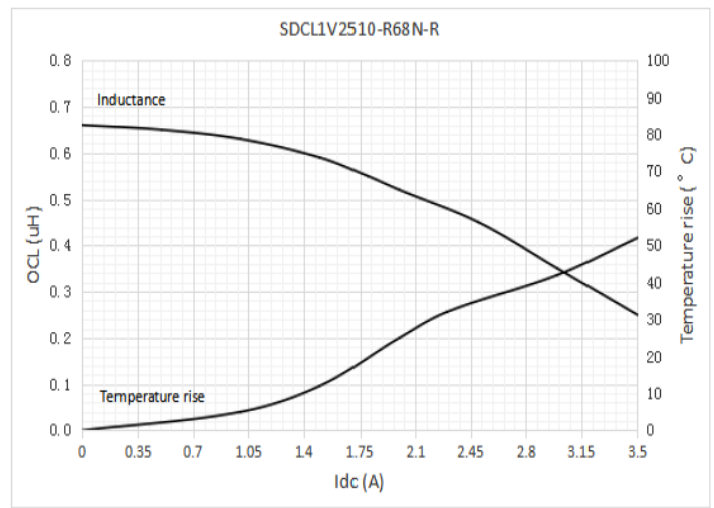
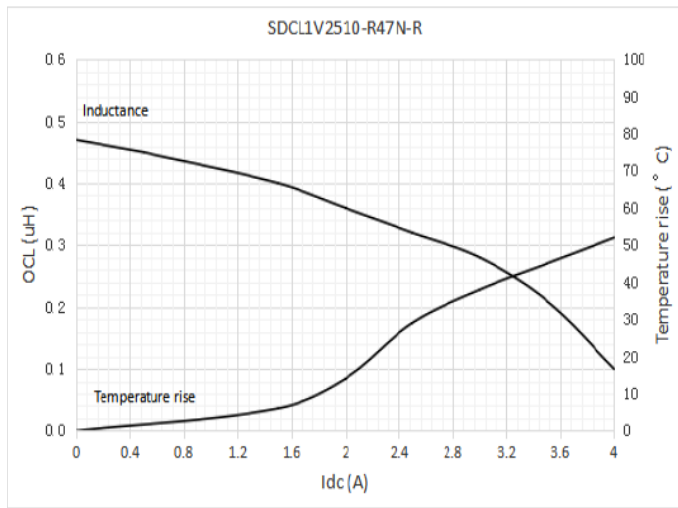

Inductance and temperature rise vs current
SDCL1V2510

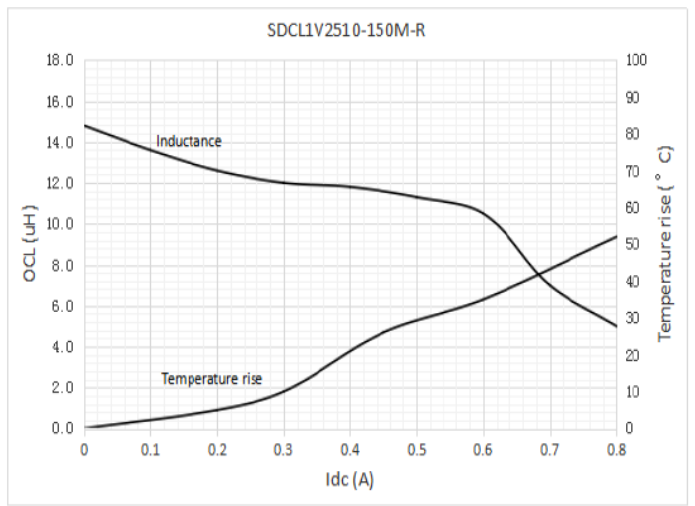
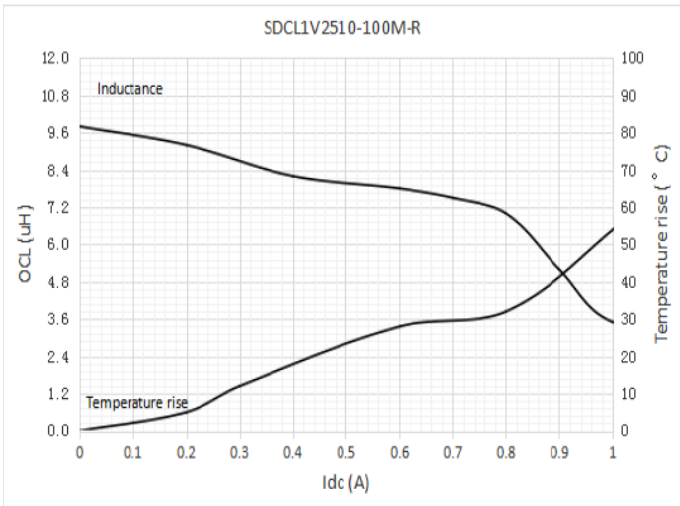
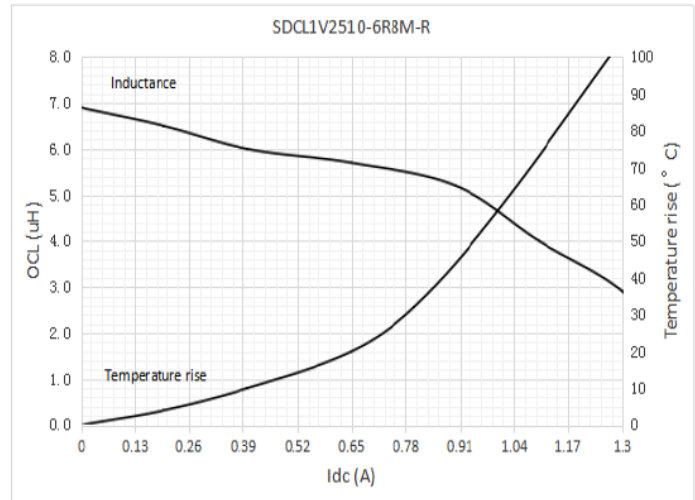
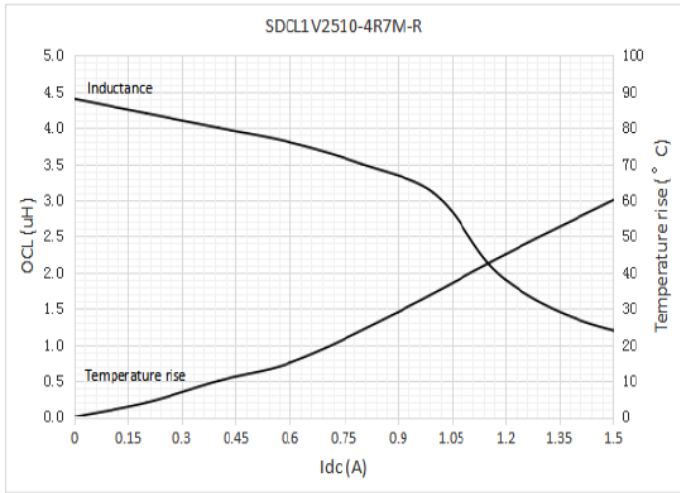

Inductance and temperature rise vs current
SDCL1V2512

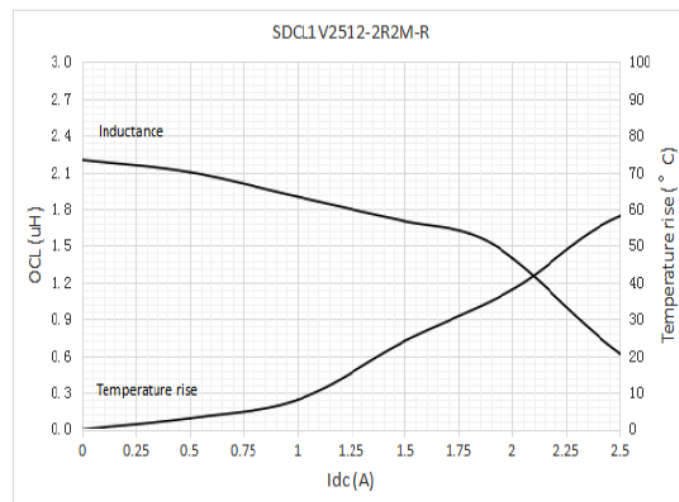
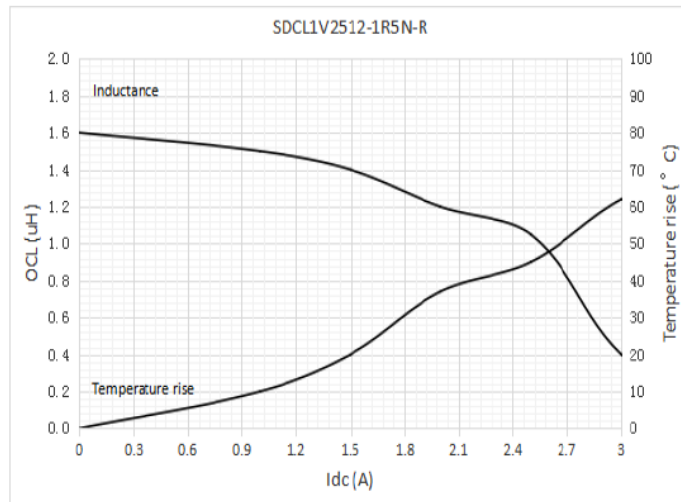
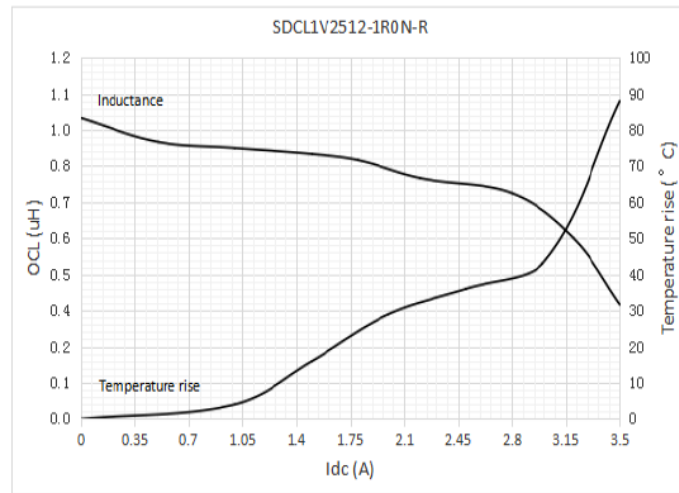
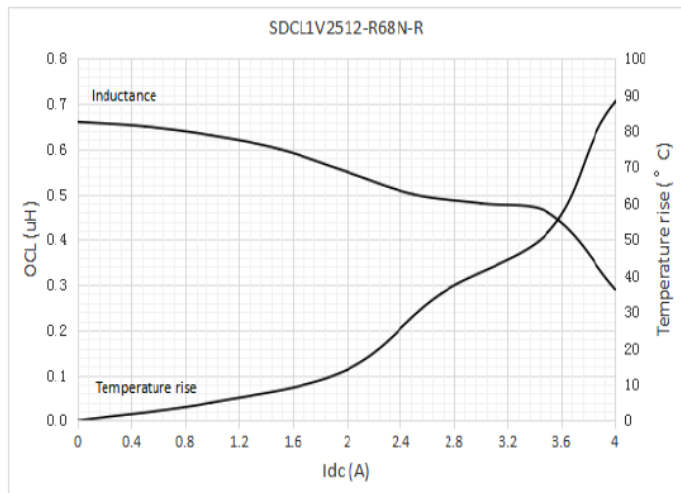
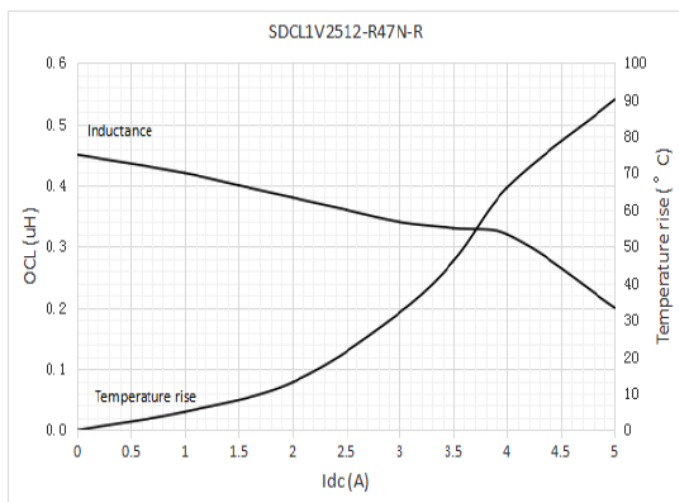
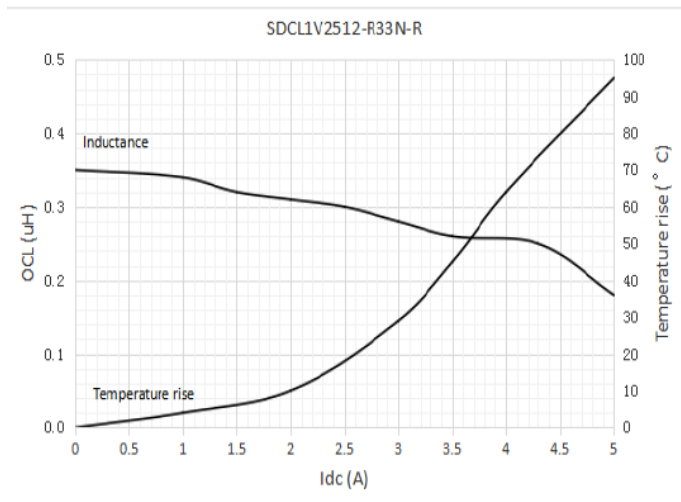

Inductance and temperature rise vs current

SDCL1V2512

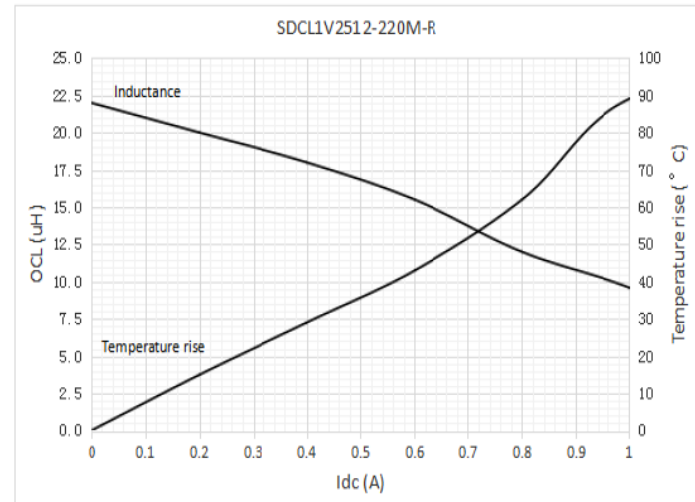
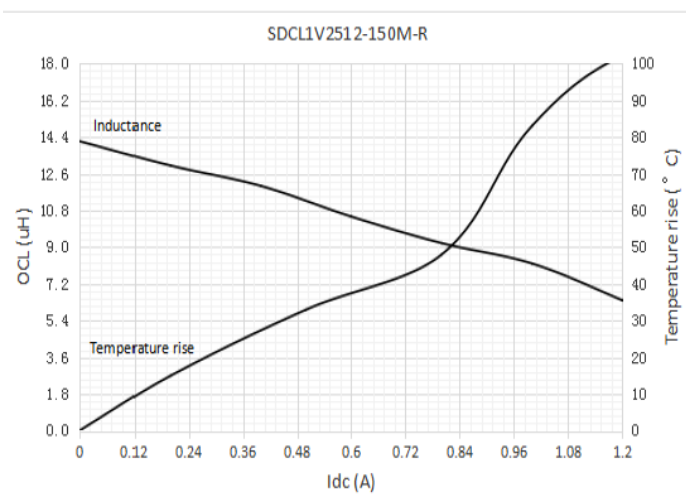
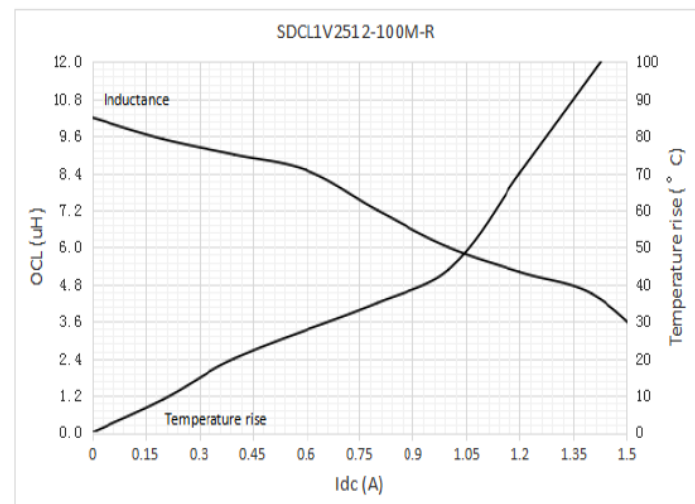
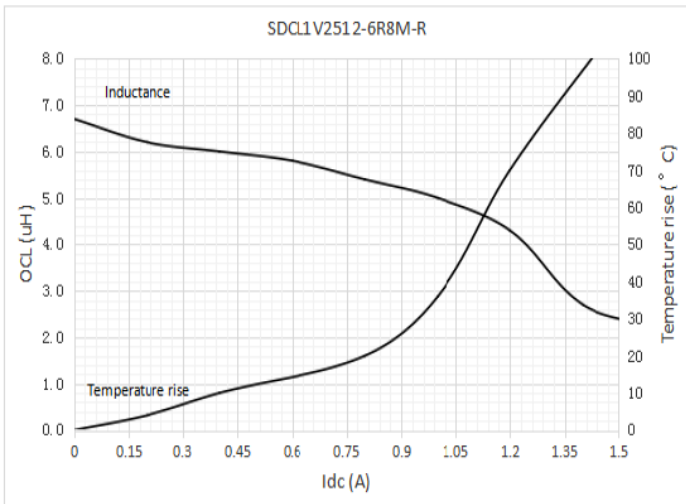
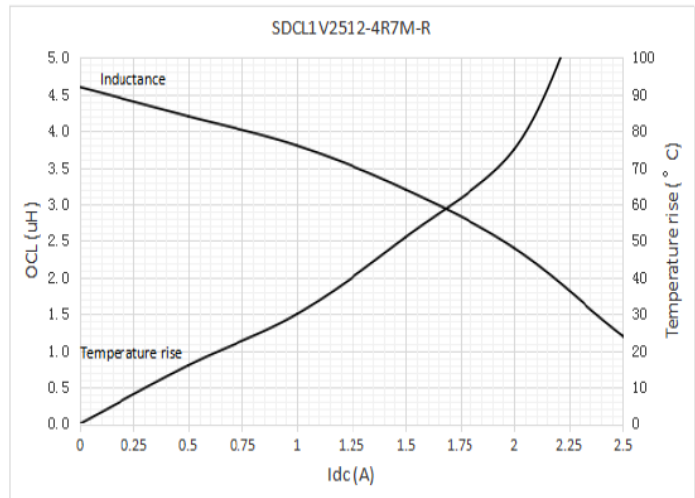
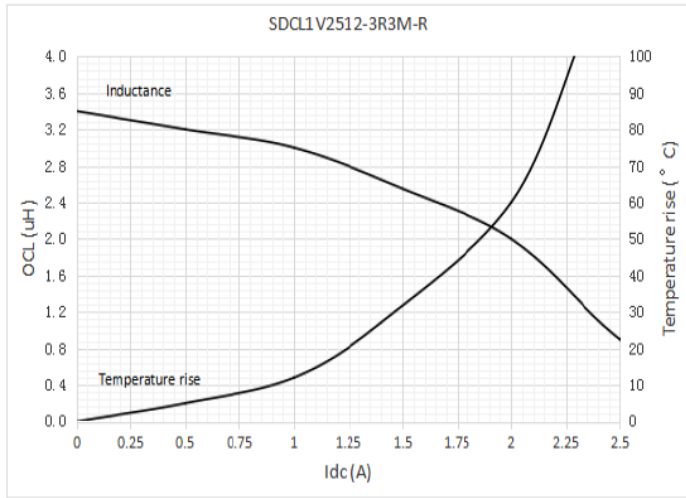

Solder reflow profile

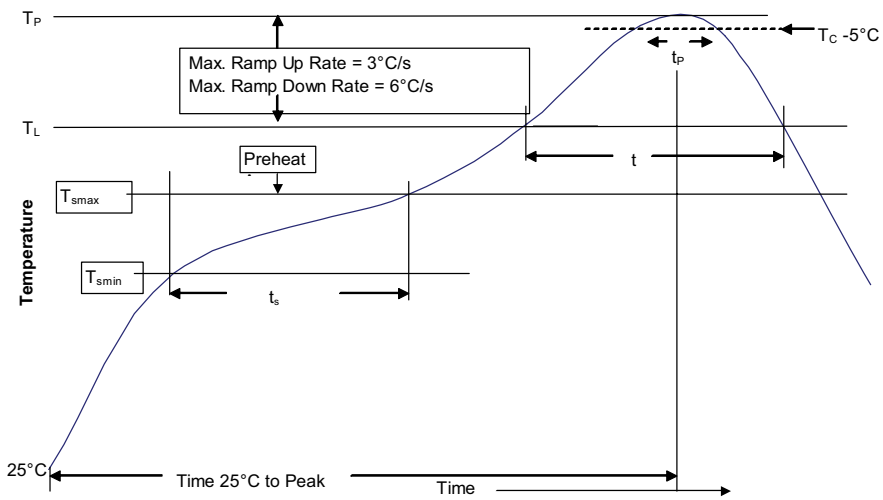

Table 1 - Standard SnPb solder (T_C)

Package thickness	Volume mm ³ <350	Volume mm ³ ≥350
<2.5 mm	235 °C	220 °C
≥2.5 mm	220 °C	220 °C

Table 2 - Lead (Pb) free solder (T_C)

Package thickness	Volume mm ³ <350	Volume mm ³ 350 - 2000	Volume mm ³ >2000
<1.6 mm	260 °C	260 °C	260 °C
1.6 – 2.5 mm	260 °C	250 °C	245 °C
>2.5 mm	250 °C	245 °C	245 °C

Reference J-STD-020

Profile feature	Standard SnPb solder	Lead (Pb) free solder
Preheat and soak		
• Temperature min. (T_{smin})	100 °C	150 °C
• Temperature max. (T_{smax})	150 °C	200 °C
• Time (T_{smin} to T_{smax}) (t_s)	60-120 seconds	60-120 seconds
Ramp up rate T_L to T_p	3 °C/ second max.	3 °C/ second max.
Liquidous temperature (T_L)	183 °C	217 °C
Time (t_L) maintained above T_L	60-150 seconds	60-150 seconds
Peak package body temperature (T_p)*	Table 1	Table 2
Time (t_p)* within 5 °C of the specified classification temperature (T_C)	20 seconds*	30 seconds*
Ramp-down rate (T_p to T_L)	6 °C/ second max.	6 °C/ second max.
Time 25 °C to peak temperature	6 minutes max.	8 minutes max.

* Tolerance for peak profile temperature (T_p) is defined as a supplier minimum and a user maximum.

Life Support Policy: Eaton does not authorize the use of any of its products for use in life support devices or systems without the express written approval of an officer of the Company. Life support systems are devices which support or sustain life, and whose failure to perform, when properly used in accordance with instructions for use provided in the labeling, can be reasonably expected to result in significant injury to the user.

Eaton reserves the right, without notice, to change design or construction of any products and to discontinue or limit distribution of any products. Eaton also reserves the right to change or update, without notice, any technical information contained in this bulletin.

Eaton
Electronics Division
1000 Eaton Boulevard
Cleveland, OH 44122
United States
Eaton.com/electronics

© 2021 Eaton
All Rights Reserved
Printed in USA
Publication No. ELX1030 BU-ELX21029
April 2021

Eaton is a registered trademark.

All other trademarks are property of their respective owners.

Follow us on social media to get the latest product and support information.

