



# PESDxL1BA series

Low capacitance bidirectional ESD protection diodes in SOD323

Rev. 02 — 20 August 2009

Product data sheet

## 1. Product profile

### 1.1 General description

Bidirectional ElectroStatic Discharge (ESD) protection diodes in a very small SOD323 (SC-76) SMD plastic package designed to protect one signal line from the damage caused by ESD and other transients.

### 1.2 Features

- Bidirectional ESD protection of one line
- Max. peak pulse power:  $P_{pp} = 500 \text{ W}$
- Low clamping voltage:  $V_{(CL)R} = 26 \text{ V}$
- Ultra low leakage current:  $I_{RM} < 0.09 \mu\text{A}$
- ESD protection  $> 23 \text{ kV}$
- IEC 61000-4-2, level 4 (ESD)
- IEC 61000-4-5 (surge);  $I_{pp} = 18 \text{ A}$
- Very small SMD plastic package

### 1.3 Applications

- Computers and peripherals
- Communication systems
- Audio and video equipment
- Data lines
- CAN bus protection


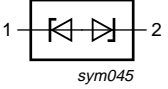
### 1.4 Quick reference data

Table 1. Quick reference data

Symbol	Parameter	Conditions	Min	Typ	Max	Unit
$V_{RWM}$	reverse stand-off voltage					
	PESD3V3L1BA		-	-	3.3	V
	PESD5V0L1BA		-	-	5.0	V
	PESD12VL1BA		-	-	12	V
	PESD15VL1BA		-	-	15	V
	PESD24VL1BA		-	-	24	V
$C_d$	diode capacitance	$V_R = 0 \text{ V};$ $f = 1 \text{ MHz}$				
	PESD3V3L1BA		-	101	-	pF
	PESD5V0L1BA		-	75	-	pF
	PESD12VL1BA		-	19	-	pF
	PESD15VL1BA		-	16	-	pF
	PESD24VL1BA		-	11	-	pF

## 2. Pinning information

Table 2. Pinning

Pin	Description	Simplified outline	Symbol
1	cathode 1		
2	cathode 2		

## 3. Ordering information

Table 3. Ordering information

Type number	Package		Version
	Name	Description	
PESDxL1BA series	SC-76	plastic surface mounted package; 2 leads	SOD323

## 4. Marking

Table 4. Marking codes

Type number	Marking code
PESD3V3L1BA	AB
PESD5V0L1BA	AC
PESD12VL1BA	AD
PESD15VL1BA	AE
PESD24VL1BA	AF

## 5. Limiting values

**Table 5. Limiting values**

In accordance with the Absolute Maximum Rating System (IEC 60134).

Symbol	Parameter	Conditions	Min	Max	Unit
P <sub>pp</sub>	peak pulse power	8/20 μs	[1]		
	PESD3V3L1BA		-	500	W
	PESD5V0L1BA		-	500	W
	PESD12VL1BA		-	200	W
	PESD15VL1BA		-	200	W
	PESD24VL1BA		-	200	W
I <sub>pp</sub>	peak pulse current	8/20 μs	[1]		
	PESD3V3L1BA		-	18	A
	PESD5V0L1BA		-	15	A
	PESD12VL1BA		-	5	A
	PESD15VL1BA		-	5	A
	PESD24VL1BA		-	3	A
T <sub>j</sub>	junction temperature		-	150	°C
T <sub>amb</sub>	ambient temperature		-65	+150	°C
T <sub>stg</sub>	storage temperature		-65	+150	°C

[1] Non-repetitive current pulse 8/20 μs exponential decay waveform; see [Figure 1](#).

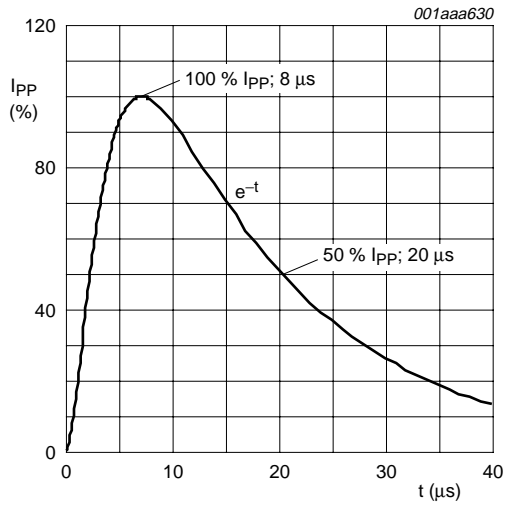
**Table 6. ESD maximum ratings**

Symbol	Parameter	Conditions	Min	Max	Unit
ESD	electrostatic discharge capability	IEC 61000-4-2 (contact discharge)	[1]		
	PESD3V3L1BA		-	30	kV
	PESD5V0L1BA		-	30	kV
	PESD12VL1BA		-	30	kV
	PESD15VL1BA		-	30	kV
	PESD24VL1BA		-	23	kV
	PESDxL1BA series	HBM MIL-Std 883	-	10	kV

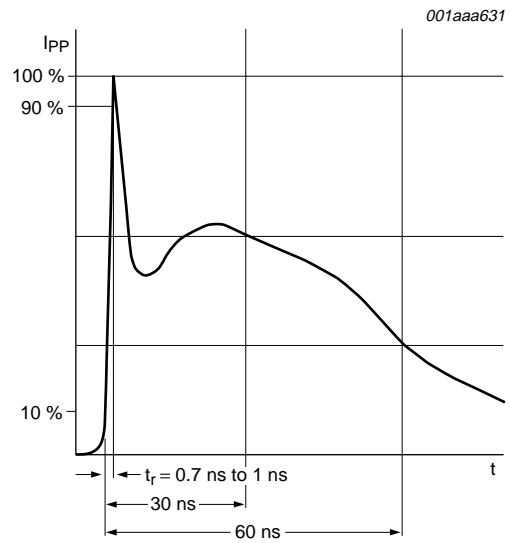
[1] Device stressed with ten non-repetitive ESD pulses; see [Figure 2](#).

**Table 7. ESD standards compliance**

Standard	Conditions
IEC 61000-4-2; level 4 (ESD); <a href="#">Figure 2</a>	> 15 kV (air); > 8 kV (contact)
HBM MIL-Std 883; class 3	> 4 kV



**Fig 1. 8/20 μs pulse waveform according to IEC 61000-4-5**



**Fig 2. ESD pulse waveform according to IEC 61000-4-2**

## 6. Characteristics

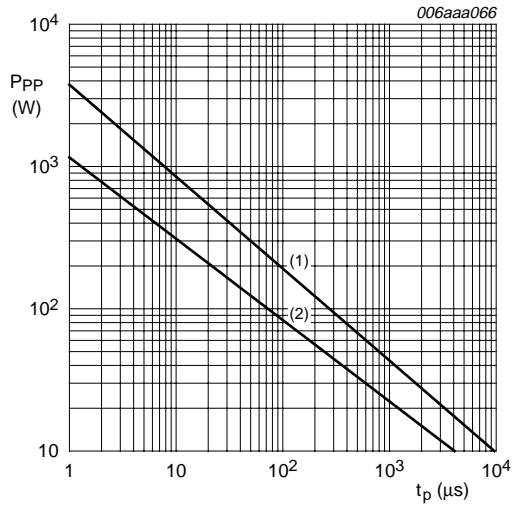
**Table 8. Characteristics**
 $T_{amb} = 25\text{ }^{\circ}\text{C}$  unless otherwise specified

Symbol	Parameter	Conditions	Min	Typ	Max	Unit
$V_{RWM}$	reverse stand-off voltage					
	PESD3V3L1BA		-	-	3.3	V
	PESD5V0L1BA		-	-	5.0	V
	PESD12VL1BA		-	-	12	V
	PESD15VL1BA		-	-	15	V
	PESD24VL1BA		-	-	24	V
$I_{RM}$	reverse leakage current	see <a href="#">Figure 7</a>				
	PESD3V3L1BA	$V_{RWM} = 3.3\text{ V}$	-	0.09	2	$\mu\text{A}$
	PESD5V0L1BA	$V_{RWM} = 5.0\text{ V}$	-	0.01	1	$\mu\text{A}$
	PESD12VL1BA	$V_{RWM} = 12\text{ V}$	-	< 1	50	nA
	PESD15VL1BA	$V_{RWM} = 15\text{ V}$	-	< 1	50	nA
	PESD24VL1BA	$V_{RWM} = 24\text{ V}$	-	< 1	50	nA
$V_{(BR)}$	breakdown voltage	$I_R = 5\text{ mA}$				
	PESD3V3L1BA		5.8	6.4	6.9	V
	PESD5V0L1BA		7.0	7.6	8.2	V
	PESD12VL1BA		14.2	15.9	16.7	V
	PESD15VL1BA		17.1	18.9	20.3	V
	PESD24VL1BA		25.4	27.8	30.3	V
$C_d$	diode capacitance	$V_R = 0\text{ V}$ ; $f = 1\text{ MHz}$ ; see <a href="#">Figure 5</a> and <a href="#">6</a>				
	PESD3V3L1BA		-	101	-	pF
	PESD5V0L1BA		-	75	-	pF
	PESD12VL1BA		-	19	-	pF
	PESD15VL1BA		-	16	-	pF
	PESD24VL1BA		-	11	-	pF
$V_{(CLR)}$	clamping voltage			<a href="#">[1]</a>		
	PESD3V3L1BA	$I_{pp} = 1\text{ A}$	-	-	8	V
		$I_{pp} = 18\text{ A}$	-	-	26	V
	PESD5V0L1BA	$I_{pp} = 1\text{ A}$	-	-	10	V
		$I_{pp} = 15\text{ A}$	-	-	33	V
	PESD12VL1BA	$I_{pp} = 1\text{ A}$	-	-	20	V
		$I_{pp} = 5\text{ A}$	-	-	37	V
	PESD15VL1BA	$I_{pp} = 1\text{ A}$	-	-	25	V
		$I_{pp} = 5\text{ A}$	-	-	44	V
	PESD24VL1BA	$I_{pp} = 1\text{ A}$	-	-	40	V
		$I_{pp} = 3\text{ A}$	-	-	70	V

**Table 8. Characteristics ...continued**  
*T<sub>amb</sub> = 25 °C unless otherwise specified*

Symbol	Parameter	Conditions	Min	Typ	Max	Unit
r <sub>dif</sub>	differential resistance	I <sub>R</sub> = 1 mA				
	PESD3V3L1BA		-	-	400	Ω
	PESD5V0L1BA		-	-	80	Ω
	PESD12VL1BA		-	-	200	Ω
	PESD15VL1BA		-	-	225	Ω
	PESD24VL1BA		-	-	300	Ω

[1] Non-repetitive current pulse 8/20 μs exponential decay waveform; see [Figure 1](#).

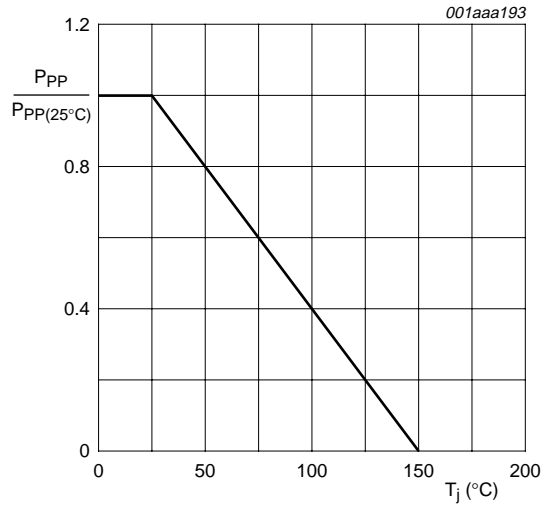


$T_{amb} = 25\text{ }^\circ\text{C}$

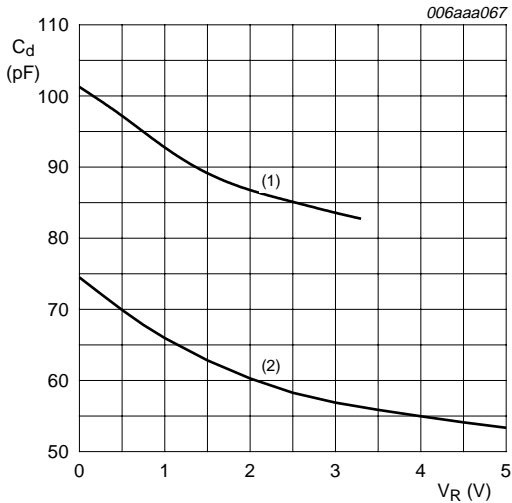
$t_p = 8/20\text{ }\mu$ s exponential decay waveform; see [Figure 1](#)

- (1) PESD3V3L1BA and PESD5V0L1BA
- (2) PESD12VL1BA; PESD15VL1BA; PESD24VL1BA

**Fig 3. Peak pulse power dissipation as a function of pulse time; typical values**



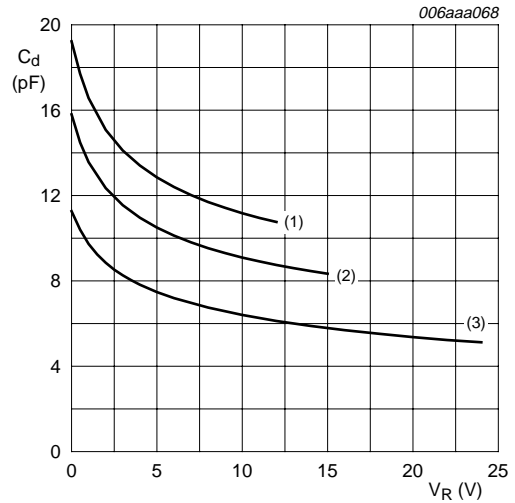
**Fig 4. Relative variation of peak pulse power as a function of junction temperature; typical values**



$T_{amb} = 25\text{ }^\circ\text{C}$ ;  $f = 1\text{ MHz}$

- (1) PESD3V3L1BA
- (2) PESD5V0L1BA

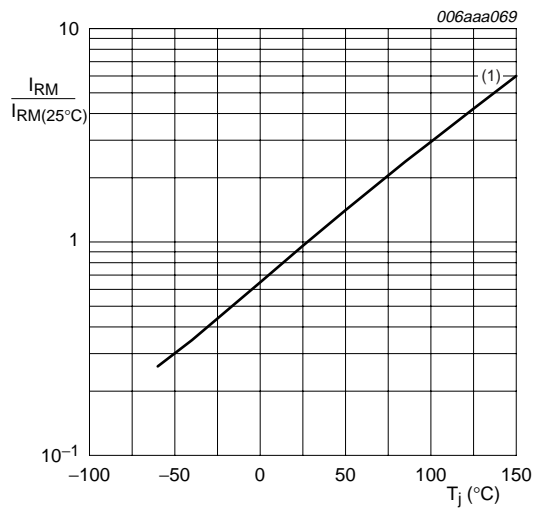
**Fig 5. Diode capacitance as a function of reverse voltage; typical values**



$T_{amb} = 25\text{ }^\circ\text{C}$ ;  $f = 1\text{ MHz}$

- (1) PESD12VL1BA
- (2) PESD15VL1BA
- (3) PESD24VL1BA

**Fig 6. Diode capacitance as a function of reverse voltage; typical values**

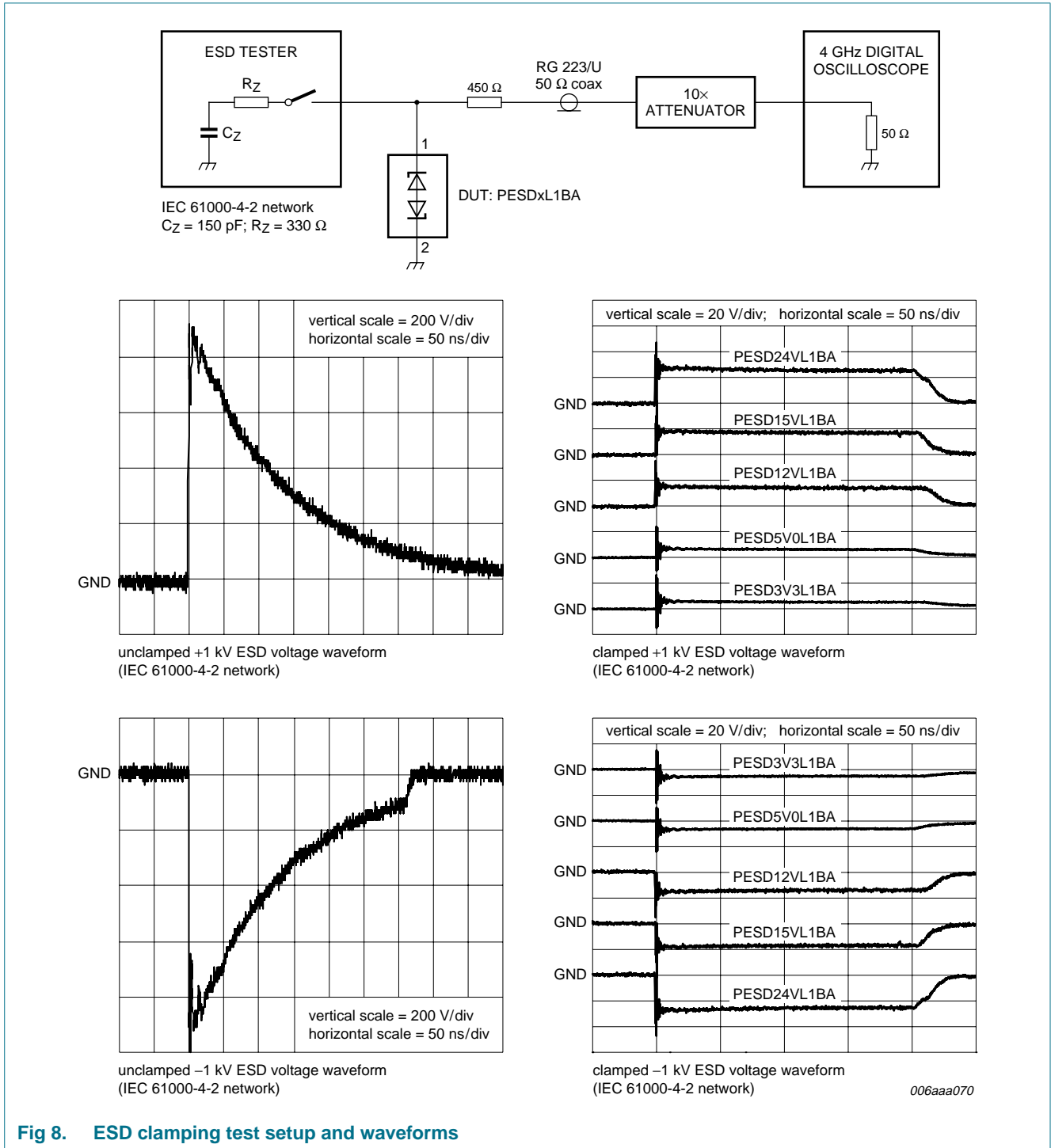


(1) PESD3V3L1BA; PESD5V0L1BA

For PESD12VL1BA, PESD15VL1BA and PESD24VL1BA,  $I_{RM} < 20 \text{ nA}$  at  $150 \text{ }^\circ\text{C}$

**Fig 7. Relative variation of reverse leakage current as a function of junction temperature; typical values**

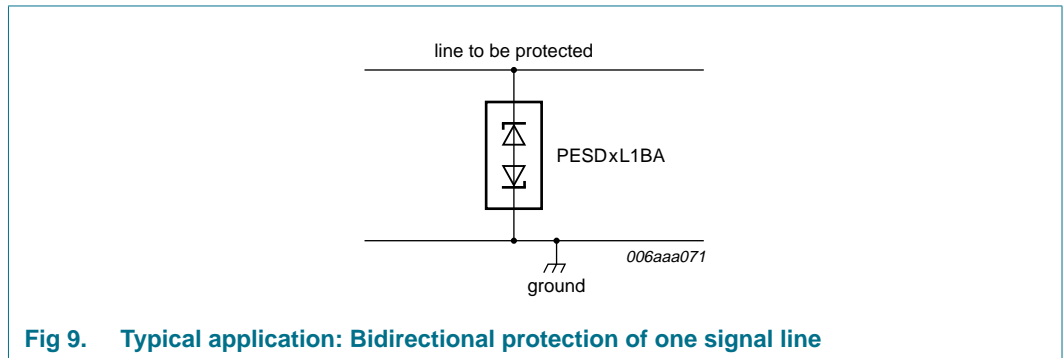




**Fig 8. ESD clamping test setup and waveforms**

## 7. Application information

The PESDxL1BA series is designed for bidirectional protection of one signal line from the damage caused by ElectroStatic Discharge (ESD) and surge pulses. The PESDxL1BA series may be used on lines where the signal polarity is above and below ground. The PESDxL1BA series provides a surge capability of up to 500 W per line for a 8/20  $\mu$ s waveform.



**Fig 9. Typical application: Bidirectional protection of one signal line**

### Circuit board layout and protection device placement

Circuit board layout is critical for the suppression of ESD, Electrical Fast Transient (EFT) and surge transients. The following guidelines are recommended:

1. Place the protection device as close to the input terminal or connector as possible.
2. The path length between the protection device and the protected line should be minimized.
3. Keep parallel signal paths to a minimum.
4. Avoid running protected conductors in parallel with unprotected conductor.
5. Minimize all printed-circuit board conductive loops including power and ground loops.
6. Minimize the length of the transient return path to ground.
7. Avoid using shared transient return paths to a common ground point.
8. Ground planes should be used whenever possible. For multilayer printed-circuit boards, use ground vias.

8. Package outline

Plastic surface-mounted package; 2 leads

SOD323

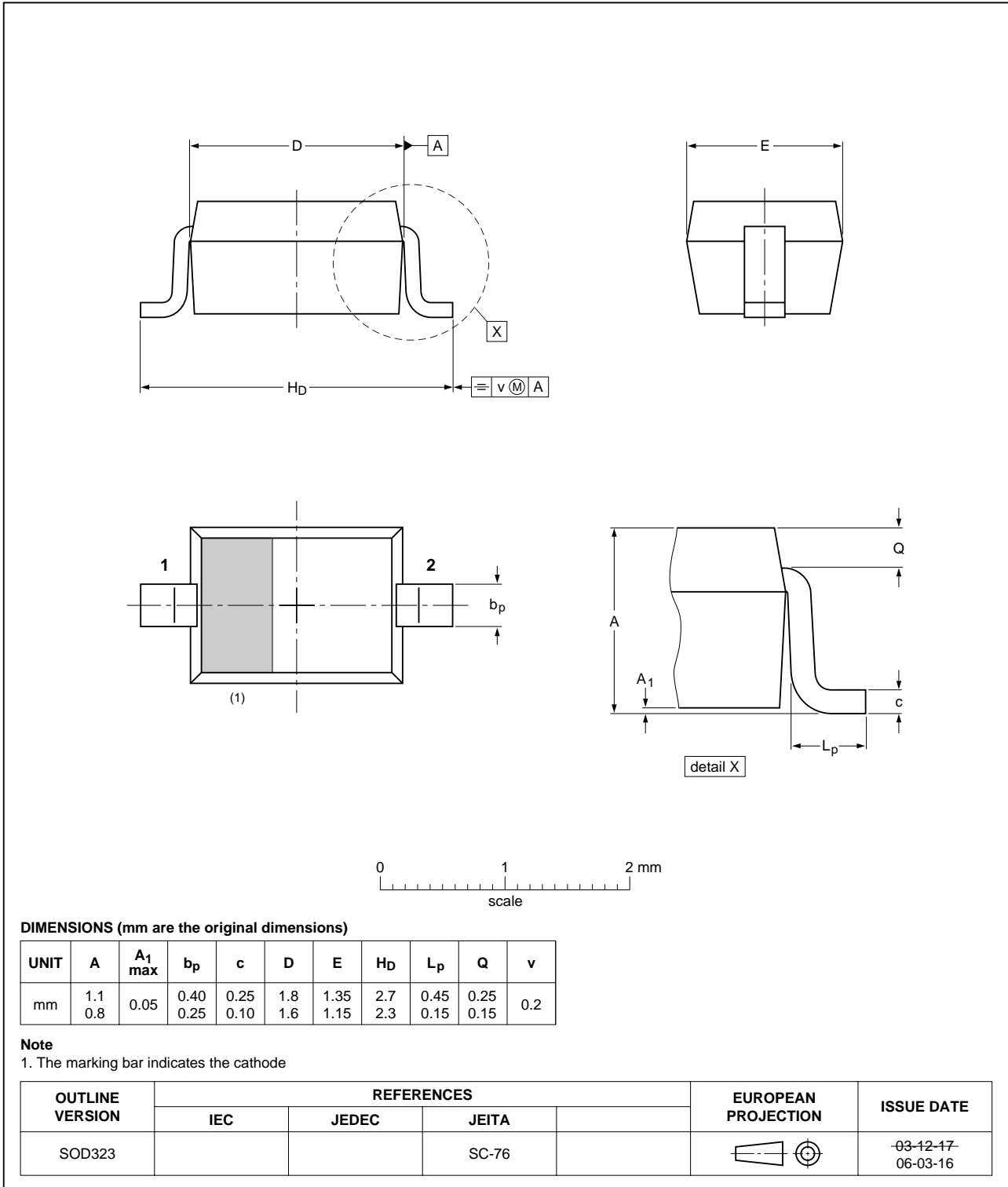


Fig 10. Package outline SOD323 (SC-76)

## 9. Packing information

**Table 9. Packing methods**

The indicated -xxx are the last three digits of the 12NC ordering code.<sup>[1]</sup>

Type number	Package	Description	Packing quantity	
			3000	10000
PESDxL1BA series	SOD323	4 mm pitch, 8 mm tape and reel	-115	-135

[1] For further information and the availability of packing methods, see [Section 12](#).

## 10. Revision history

Table 10. Revision history

Document ID	Release date	Data sheet status	Change notice	Supersedes
PESDXL1BA_SER_2	20090820	Product data sheet	-	PESDXL1BA_SER_1
Modifications:				
		<ul style="list-style-type: none"><li>This data sheet was changed to reflect the new company name NXP Semiconductors, including new legal definitions and disclaimers. No changes were made to the technical content.</li><li><a href="#">Figure 10 "Package outline SOD323 (SC-76)":</a> updated</li></ul>		
PESDXL1BA_SER_1	20041004	Product data sheet	-	-

## 11. Legal information

### 11.1 Data sheet status

Document status <sup>[1][2]</sup>	Product status <sup>[3]</sup>	Definition
Objective [short] data sheet	Development	This document contains data from the objective specification for product development.
Preliminary [short] data sheet	Qualification	This document contains data from the preliminary specification.
Product [short] data sheet	Production	This document contains the product specification.

[1] Please consult the most recently issued document before initiating or completing a design.

[2] The term 'short data sheet' is explained in section "Definitions".

[3] The product status of device(s) described in this document may have changed since this document was published and may differ in case of multiple devices. The latest product status information is available on the Internet at URL <http://www.nexperia.com>.

### 11.2 Definitions

**Draft** — The document is a draft version only. The content is still under internal review and subject to formal approval, which may result in modifications or additions. Nexperia does not give any representations or warranties as to the accuracy or completeness of information included herein and shall have no liability for the consequences of use of such information.

**Short data sheet** — A short data sheet is an extract from a full data sheet with the same product type number(s) and title. A short data sheet is intended for quick reference only and should not be relied upon to contain detailed and full information. For detailed and full information see the relevant full data sheet, which is available on request via the local Nexperia sales office. In case of any inconsistency or conflict with the short data sheet, the full data sheet shall prevail.

### 11.3 Disclaimers

**General** — Information in this document is believed to be accurate and reliable. However, Nexperia does not give any representations or warranties, expressed or implied, as to the accuracy or completeness of such information and shall have no liability for the consequences of use of such information.

**Right to make changes** — Nexperia reserves the right to make changes to information published in this document, including without limitation specifications and product descriptions, at any time and without notice. This document supersedes and replaces all information supplied prior to the publication hereof.

**Suitability for use** — Nexperia products are not designed, authorized or warranted to be suitable for use in medical, military, aircraft, space or life support equipment, nor in applications where failure or malfunction of a Nexperia product can reasonably be expected to result in personal injury, death or severe property or environmental

damage. Nexperia accepts no liability for inclusion and/or use of Nexperia products in such equipment or applications and therefore such inclusion and/or use is at the customer's own risk.

**Applications** — Applications that are described herein for any of these products are for illustrative purposes only. Nexperia makes no representation or warranty that such applications will be suitable for the specified use without further testing or modification.

**Limiting values** — Stress above one or more limiting values (as defined in the Absolute Maximum Ratings System of IEC 60134) may cause permanent damage to the device. Limiting values are stress ratings only and operation of the device at these or any other conditions above those given in the Characteristics sections of this document is not implied. Exposure to limiting values for extended periods may affect device reliability.

**Terms and conditions of sale** — Nexperia products are sold subject to the general terms and conditions of commercial sale, as published at <http://www.nexperia.com/profile/terms>, including those pertaining to warranty, intellectual property rights infringement and limitation of liability, unless explicitly otherwise agreed to in writing by Nexperia. In case of any inconsistency or conflict between information in this document and such terms and conditions, the latter will prevail.

**No offer to sell or license** — Nothing in this document may be interpreted or construed as an offer to sell products that is open for acceptance or the grant, conveyance or implication of any license under any copyrights, patents or other industrial or intellectual property rights.

**Export control** — This document as well as the item(s) described herein may be subject to export control regulations. Export might require a prior authorization from national authorities.

**Quick reference data** — The Quick reference data is an extract of the product data given in the Limiting values and Characteristics sections of this document, and as such is not complete, exhaustive or legally binding.

### 11.4 Trademarks

Notice: All referenced brands, product names, service names and trademarks are the property of their respective owners.

## 12. Contact information

For more information, please visit: <http://www.nexperia.com>

For sales office addresses, please send an email to: [salesaddresses@nexperia.com](mailto:salesaddresses@nexperia.com)

## 13. Contents

---

<b>1</b>	<b>Product profile</b> . . . . .	<b>1</b>
1.1	General description. . . . .	1
1.2	Features . . . . .	1
1.3	Applications . . . . .	1
1.4	Quick reference data. . . . .	1
<b>2</b>	<b>Pinning information</b> . . . . .	<b>2</b>
<b>3</b>	<b>Ordering information</b> . . . . .	<b>2</b>
<b>4</b>	<b>Marking</b> . . . . .	<b>2</b>
<b>5</b>	<b>Limiting values</b> . . . . .	<b>3</b>
<b>6</b>	<b>Characteristics</b> . . . . .	<b>5</b>
<b>7</b>	<b>Application information</b> . . . . .	<b>10</b>
<b>8</b>	<b>Package outline</b> . . . . .	<b>11</b>
<b>9</b>	<b>Packing information</b> . . . . .	<b>12</b>
<b>10</b>	<b>Revision history</b> . . . . .	<b>13</b>
<b>11</b>	<b>Legal information</b> . . . . .	<b>14</b>
11.1	Data sheet status . . . . .	14
11.2	Definitions . . . . .	14
11.3	Disclaimers . . . . .	14
11.4	Trademarks. . . . .	14
<b>12</b>	<b>Contact information</b> . . . . .	<b>14</b>
<b>13</b>	<b>Contents</b> . . . . .	<b>15</b>