

Rail-to-rail 1.8 V high-speed dual comparator

TS3022
SO-8/MiniSO-8

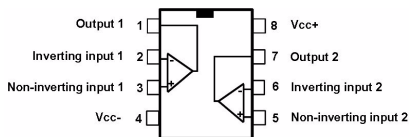

Pin connections (top view)



Features

- Propagation delay: 38 ns
- Low current consumption: 73 μ A
- Rail-to-rail inputs
- Push-pull outputs
- Supply operation from 1.8 to 5 V
- Wide temperature range: -40 °C to 125 °C
- ESD tolerance: 5 kV HBM, 300 V MM
- Latch-up immunity: 200 mA
- SMD packages
- Automotive qualification

Applications

- Telecom
- Instrumentation
- Signal conditioning
- High-speed sampling systems
- Portable communication systems
- Automotive

Maturity status link

[TS3022](#)

Description

The **TS3022** dual comparator features a high speed response time with rail-to-rail inputs. With a supply voltage specified from 2 to 5 V, this comparator can operate over a wide temperature range: -40 °C to 125 °C.

The **TS3022** comparator offers micropower consumption as low as a few tens of microamperes thus providing an excellent ratio of power consumption current versus response time.

The **TS3022** includes push-pull outputs and is available in small packages (SMD): SO-8 and MiniSO-8.

1 Absolute maximum ratings and operating conditions

Table 1. Absolute maximum ratings (AMR)

Symbol	Parameter	Value	Unit	
V_{CC}	Supply voltage ⁽¹⁾	5.5	V	
V_{ID}	Differential input voltage ⁽²⁾	±5		
V_{IN}	Input voltage range	$(V_{CC-}) - 0.3$ to $(V_{CC+}) + 0.3$		
R_{thja}	Thermal resistance junction-to-ambient ⁽³⁾	SO-8	125	°C/W
		MiniSO-8	90	
R_{thjc}	Thermal resistance junction-to-case ⁽³⁾	SO-8	40	
		MiniSO-8	39	
T_{stg}	Storage temperature	-65 to 150	°C	
T_j	Junction temperature	150		
T_{LEAD}	Lead temperature (soldering 10 s)	260		
ESD	HBM: human body model ⁽⁴⁾	5000	V	
	MM: machine model ⁽⁵⁾	300		
	CDM : charged device model for TS3022IDT and TS3022IST ⁽⁶⁾	1500		
	CDM : charged device model for TS3022IYST ⁽⁶⁾	1400		
	Latch-up immunity	200	mA	

1. All voltage values, except the differential voltage are referenced to (V_{CC-}) . V_{CC} is defined as the difference between V_{CC+} and V_{CC-} .
2. The magnitude of the input and output voltages must never exceed the supply rail ± 0.3 V.
3. Short-circuits can cause excessive heating. These are typical values.
4. Human body model: a 100 pF capacitor is charged to the specified voltage, then discharged through a 1.5 kΩ resistor between two pins of the device. This is done for all couples of connected pin combinations while the other pins are floating.
5. Machine model: a 200 pF capacitor is charged to the specified voltage, then discharged directly between two pins of the device with no external series resistor (internal resistor < 5 Ω). This is done for all couples of connected pin combinations while the other pins are floating.
6. Charged device model: all pins and the package are charged together to the specified voltage and then discharged directly to the ground through only one pin. This is done for all pins.

Table 2. Operating conditions

Symbol	Parameter	Value	Unit	
V_{CC}	Supply voltage	0 °C < T_{amb} < +125 °C	1.8 to 5	V
		-40 °C < T_{amb} < +125 °C	2 to 5	
V_{icm}	Common mode input voltage range	-40 °C < T_{amb} < 85 °C	$(V_{CC-}) - 0.2$ to $(V_{CC+}) + 0.2$	
		+85 °C < T_{amb} < +125 °C	(V_{CC-}) to (V_{CC+})	
T_{oper}	Operating temperature range	-40 to 125	°C	

2 Electrical characteristics

Table 3. Electrical characteristics at $V_{CC+} = 2\text{ V}$, $V_{CC-} = 0\text{ V}$, $T_{amb} = 25\text{ °C}$, and full V_{icm} range (unless otherwise specified)

Symbol	Parameter	Test conditions ⁽¹⁾	Min.	Typ.	Max.	Unit
V_{IO}	Input offset voltage	-40 °C < T_{amb} < +125 °C, TS3021A		0.5	6	mV
					7	
$\Delta V_{IO}/\Delta T$	Input offset voltage drift	-40 °C < T_{amb} < 125 °C		3	20	$\mu\text{V}/\text{°C}$
I_{IO}	Input offset current ⁽²⁾	T_{amb}		1	20	nA
		-40 °C < T_{amb} < +125 °C			100	
I_{IB}	Input bias current ⁽²⁾	T_{amb}		86	160	nA
		-40 °C < T_{amb} < 125 °C			300	
I_{CC}	Supply current	No load, output high, $V_{icm} = 0\text{ V}$		73	90	μA
		No load, output high, $V_{icm} = 0\text{ V}$, -40 °C < T_{amb} < 125 °C			115	
		No load, output low, $V_{icm} = 0\text{ V}$		84	105	
		No load, output low, $V_{icm} = 0\text{ V}$, -40 °C < T_{amb} < 125 °C			125	
I_{SC}	Short-circuit current	Source		9		mA
		Sink		10		
V_{OH}	Output voltage high	$I_{source} = 1\text{ mA}$	1.88	1.92		V
		-40 °C < T_{amb} < 125 °C	1.80			
V_{OL}	Output voltage low	$I_{sink} = 1\text{ mA}$		60	100	mV
		-40 °C < T_{amb} < 125 °C			150	
CMRR	Common mode rejection ratio	$0 < V_{icm} < 2\text{ V}$		67		dB
SVR	Supply voltage rejection	$\Delta V_{CC} = 2\text{ to }5\text{ V}$	58	73		
TP_{LH}	Propagation delay, low to high output level ⁽³⁾	$V_{icm} = 0\text{ V}$, $f = 10\text{ kHz}$, $CL = 50\text{ pF}$, overdrive = 100 mV		38	60	ns
		$V_{icm} = 0\text{ V}$, $f = 10\text{ kHz}$, $CL = 50\text{ pF}$, overdrive = 20 mV		48	75	
TP_{HL}	Propagation delay, high to low output level ⁽⁴⁾	$V_{icm} = 0\text{ V}$, $f = 10\text{ kHz}$, $CL = 50\text{ pF}$, overdrive = 100 mV		40	60	ns
		$V_{icm} = 0\text{ V}$, $f = 10\text{ kHz}$, $CL = 50\text{ pF}$, overdrive = 20 mV		49	75	
T_F	Fall time	$f = 10\text{ kHz}$, $CL = 50\text{ pF}$, $RL = 10\text{ k}\Omega$, overdrive = 100 mV		8		
T_R	Rise time	$f = 10\text{ kHz}$, $CL = 50\text{ pF}$, $RL = 10\text{ k}\Omega$, overdrive = 100 mV		9		

1. All values over the temperature range are guaranteed through correlation and simulation. No production test is performed at the temperature range limits.
2. Maximum values include unavoidable inaccuracies of the industrial tests
3. Response time is measured at 50% of the final output value with the following conditions: inverting input voltage ($IN-$) = V_{icm} and non-inverting input voltage ($IN+$) moving from $V_{icm} - 100\text{ mV}$ to $V_{icm} + \text{overdrive}$.
4. Response time is measured at 50% of the final output value with the following conditions: inverting input voltage ($IN-$) = V_{icm} and non-inverting input voltage ($IN+$) moving from $V_{icm} + 100\text{ mV}$ to $V_{icm} - \text{overdrive}$.

Table 4. Electrical characteristics at $V_{CC+} = 3.3\text{ V}$, $V_{CC-} = 0\text{ V}$, $T_{amb} = 25\text{ °C}$, and full V_{icm} range (unless otherwise specified)

Symbol	Parameter	Test conditions ⁽¹⁾	Min.	Typ.	Max.	Unit
V_{IO}	Input offset voltage	$-40\text{ °C} < T_{amb} < 125\text{ °C}$		0.2	6	mV
					7	
$\Delta V_{IO}/\Delta T$	Input offset voltage drift	$-40\text{ °C} < T_{amb} < 125\text{ °C}$		3	20	$\mu\text{V}/\text{°C}$
I_{IO}	Input offset current ⁽²⁾	T_{amb}		1	20	nA
		$-40\text{ °C} < T_{amb} < +125\text{ °C}$			100	
I_{IB}	Input bias current ⁽²⁾	T_{amb}		86	160	
		$-40\text{ °C} < T_{amb} < +125\text{ °C}$			300	
I_{CC}	Supply current	No load, output high, $V_{icm} = 0\text{ V}$		75	90	μA
		No load, output high, $V_{icm} = 0\text{ V}$, $-40\text{ °C} < T_{amb} < 125\text{ °C}$			120	
		No load, output low, $V_{icm} = 0\text{ V}$		86	110	
		No load, output low, $V_{icm} = 0\text{ V}$, $-40\text{ °C} < T_{amb} < 125\text{ °C}$			125	
I_{SC}	Short-circuit current	Source		26		mA
		Sink		24		
V_{OH}	Output voltage high	$I_{source} = 1\text{ mA}$	3.20	3.25		V
		$-40\text{ °C} < T_{amb} < 125\text{ °C}$	3.10			
V_{OL}	Output voltage low	$I_{sink} = 1\text{ mA}$		40	80	mV
		$-40\text{ °C} < T_{amb} < 125\text{ °C}$			150	
CMRR	Common mode rejection ratio	$0 < V_{icm} < 3.3\text{ V}$		75		dB
SVR	Supply voltage rejection	$\Delta V_{CC} = 2\text{ to }5\text{ V}$	58	73		
TP_{LH}	Propagation delay, low to high output level ⁽³⁾	$V_{icm} = 0\text{ V}$, $f = 10\text{ kHz}$, $CL = 50\text{ pF}$, overdrive = 100 mV		39	65	
		$V_{icm} = 0\text{ V}$, $f = 10\text{ kHz}$, $CL = 50\text{ pF}$, overdrive = 20 mV		50	85	
TP_{HL}	Propagation delay, high to low output level ⁽⁴⁾	$V_{icm} = 0\text{ V}$, $f = 10\text{ kHz}$, $CL = 50\text{ pF}$, overdrive = 100 mV		41	65	ns
		$V_{icm} = 0\text{ V}$, $f = 10\text{ kHz}$, $CL = 50\text{ pF}$, overdrive = 20 mV		51	80	
T_F	Fall time	$f = 10\text{ kHz}$, $CL = 50\text{ pF}$, $RL = 10\text{ k}\Omega$, overdrive = 100 mV		5		
T_R	Rise time	$f = 10\text{ kHz}$, $CL = 50\text{ pF}$, $RL = 10\text{ k}\Omega$, overdrive = 100 mV		7		

1. All values over the temperature range are guaranteed through correlation and simulation. No production test is performed at the temperature range limits.
2. Maximum values include unavoidable inaccuracies of the industrial tests.
3. Response time is measured at 50% of the final output value with the following conditions: inverting input voltage ($IN-$) = V_{icm} and non-inverting input voltage ($IN+$) moving from $V_{icm} - 100\text{ mV}$ to $V_{icm} + \text{overdrive}$.
4. Response time is measured at 50% of the final output value with the following conditions: Inverting input voltage ($IN-$) = V_{icm} and non-inverting input voltage ($IN+$) moving from $V_{icm} + 100\text{ mV}$ to $V_{icm} - \text{overdrive}$.

Table 5. Electrical characteristics at $V_{CC} = 5\text{ V}$, $T_{amb} = 25\text{ °C}$, and full V_{icm} range (unless otherwise specified)

Symbol	Parameter	Test conditions ⁽¹⁾	Min.	Typ.	Max.	Unit
V_{IO}	Input offset voltage	-40 °C < T_{amb} < 125 °C, TS3021A		0.2	6	mV
					7	
$\Delta V_{IO}/\Delta T$	Input offset voltage drift	-40 °C < T_{amb} < 125 °C		3	20	$\mu\text{V}/\text{°C}$
I_{IO}	Input offset current ⁽²⁾	T_{amb}		1	20	nA
		-40 °C < T_{amb} < +125 °C			100	
I_{IB}	Input bias current ⁽²⁾	T_{amb}		86	160	nA
		-40 °C < T_{amb} < +125 °C			300	
I_{CC}	Supply current	No load, output high, $V_{icm} = 0\text{ V}$		77	95	μA
		No load, output high, $V_{icm} = 0\text{ V}$, -40 °C < T_{amb} < 125 °C			125	
		No load, output low, $V_{icm} = 0\text{ V}$		89	115	
		No load, output low, $V_{icm} = 0\text{ V}$, -40 °C < T_{amb} < 125 °C			135	
I_{SC}	Short-circuit current	Source		51		mA
		Sink		40		
V_{OH}	Output voltage high	$I_{source} = 4\text{ mA}$	4.80	4.84		V
		-40 °C < T_{amb} < 125 °C	4.70			
V_{OL}	Output voltage low	$I_{sink} = 4\text{ mA}$		130	180	mV
		-40 °C < T_{amb} < 125 °C			250	
CMRR	Common mode rejection ratio	$0 < V_{icm} < 5\text{ V}$		79		dB
SVR	Supply voltage rejection	$\Delta V_{CC} = 2\text{ to }5\text{ V}$	58	73		
TP_{LH}	Propagation delay, low to high output level ⁽³⁾	$V_{icm} = 0\text{ V}$, $f = 10\text{ kHz}$, $CL = 50\text{ pF}$, overdrive = 100 mV		42	75	ns
		$V_{icm} = 0\text{ V}$, $f = 10\text{ kHz}$, $CL = 50\text{ pF}$, overdrive = 20 mV		54	105	
TP_{HL}	Propagation delay, high to low output level ⁽⁴⁾	$V_{icm} = 0\text{ V}$, $f = 10\text{ kHz}$, $CL = 50\text{ pF}$, overdrive = 100 mV		45	75	ns
		$V_{icm} = 0\text{ V}$, $f = 10\text{ kHz}$, $CL = 50\text{ pF}$, overdrive = 20 mV		55	95	
T_F	Fall time	$f = 10\text{ kHz}$, $CL = 50\text{ pF}$, $RL = 10\text{ k}\Omega$, overdrive = 100 mV		4		ns
T_R	Rise time	$f = 10\text{ kHz}$, $CL = 50\text{ pF}$, $RL = 10\text{ k}\Omega$, overdrive = 100 mV		4		ns

1. All values over the temperature range are guaranteed through correlation and simulation. No production test is performed at the temperature range limits.
2. Maximum values include unavoidable inaccuracies of the industrial tests.
3. Response time is measured 10%/90% of the final output value with the following conditions: inverting input voltage (IN^-) = V_{icm} and non-inverting input voltage (IN^+) moving from $V_{icm} - 100\text{ mV}$ to $V_{icm} + \text{overdrive}$.
4. Response time is measured 10%/90% of the final output value with the following conditions: Inverting input voltage (IN^-) = V_{icm} and non-inverting input voltage (IN^+) moving from $V_{icm} + 100\text{ mV}$ to $V_{icm} - \text{overdrive}$.

3 Electrical characteristic curves

Figure 1. Current consumption vs. supply voltage (V_{icm} = 0 V, output high)

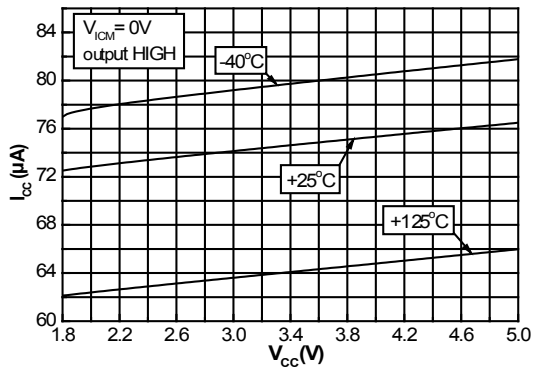

Figure 2. Current consumption vs. supply voltage (V_{icm} = V_{cc} output high)

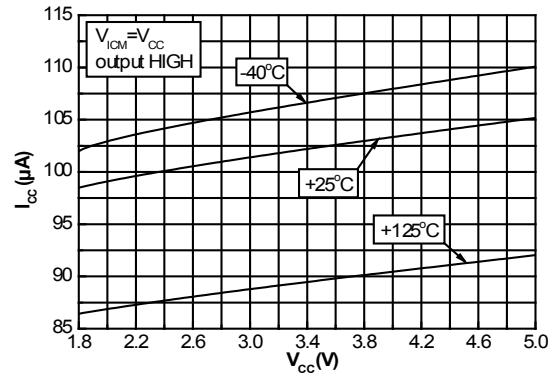

Figure 3. Current consumption vs. supply voltage (V_{icm} = 0 V, output low)

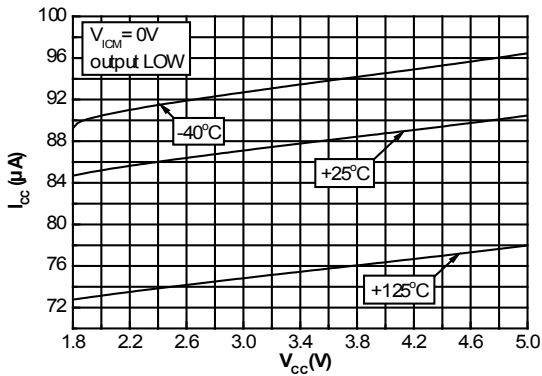

Figure 4. Current consumption vs. supply voltage (V_{icm} = V_{cc} output low)

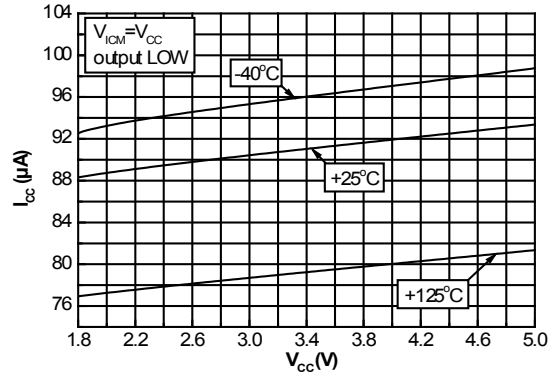

Figure 5. Output voltage vs. source current, V_{cc} = 2 V

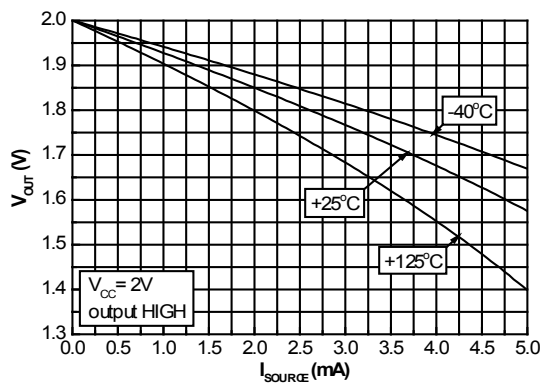

Figure 6. Output voltage vs. sink current, V_{cc} = 2 V

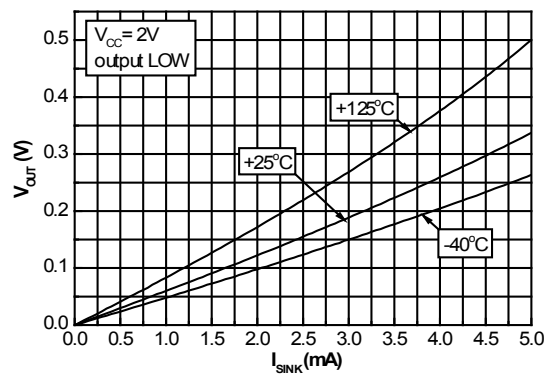

Figure 7. Output voltage vs. source current, $V_{CC} = 3.3\text{ V}$

Figure 8. Output voltage vs. sink current, $V_{CC} = 3.3\text{ V}$

Figure 9. Output voltage vs. source current, $V_{CC} = 5\text{ V}$

Figure 10. Output voltage vs. sink current, $V_{CC} = 5\text{ V}$

Figure 11. Input offset voltage vs. temperature and common mode voltage

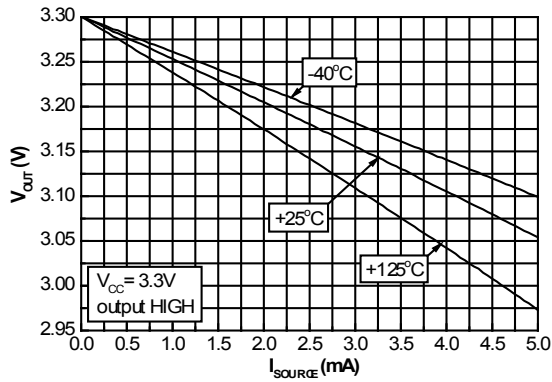
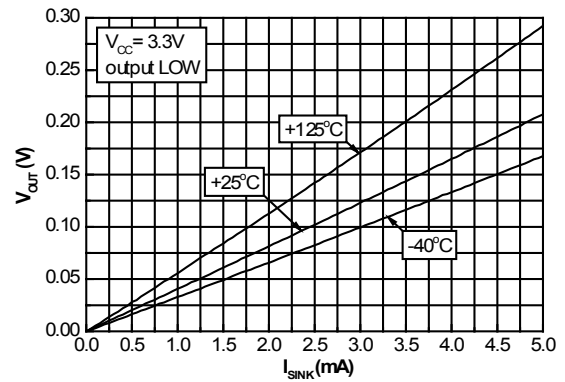
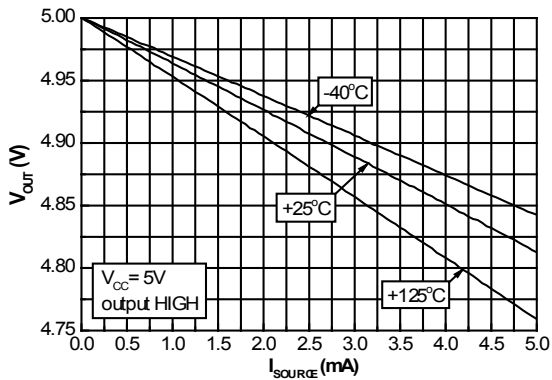
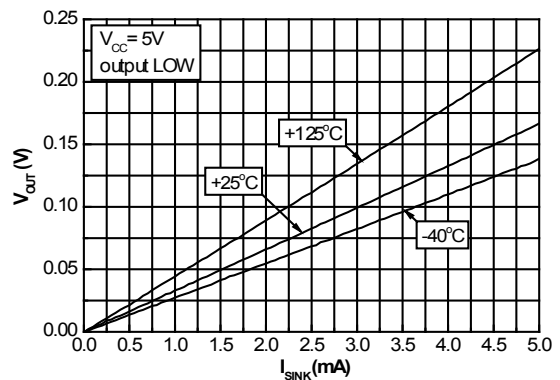
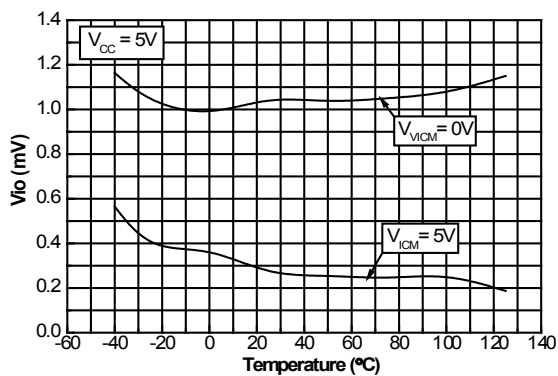
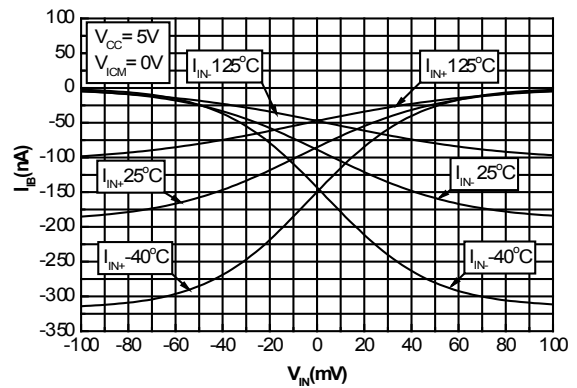
Figure 12. Input bias current vs. temperature and input voltage

Figure 13. Current consumption vs. commutation frequency

Figure 14. Propagation delay (HL) vs. overdrive at $V_{CC} = 2V$, $V_{ICM} = 0V$

Figure 15. Propagation delay (HL) vs. overdrive at $V_{CC} = 2V$, $V_{ICM} = V_{CC}$

Figure 16. Propagation delay (LH) vs. overdrive at $V_{CC} = 2V$, $V_{ICM} = 0V$

Figure 17. Propagation delay (LH) vs. overdrive at $V_{CC} = 2V$, $V_{ICM} = V_{CC}$

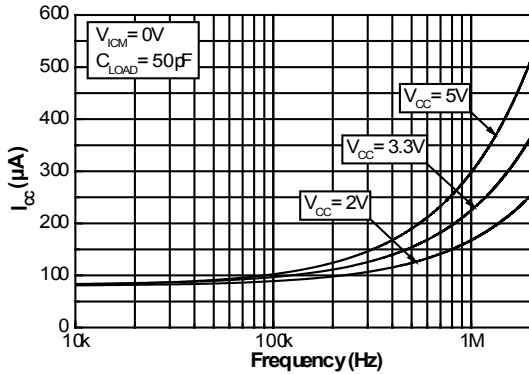
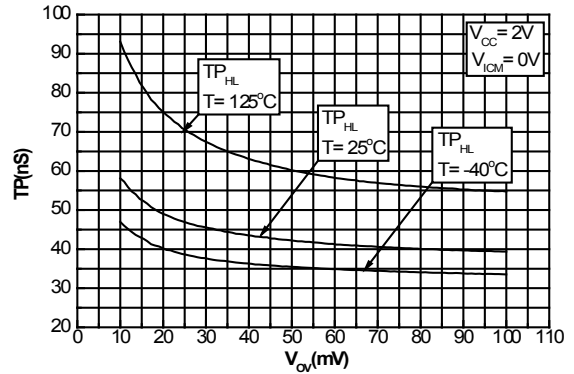
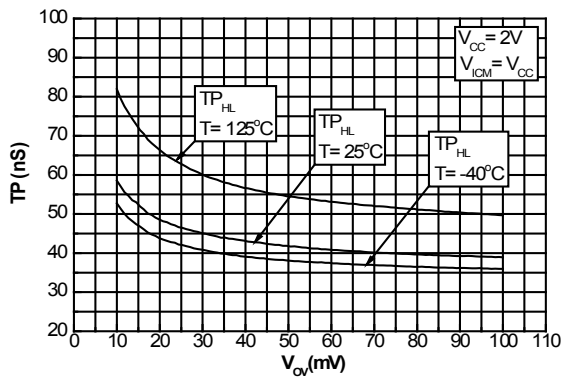
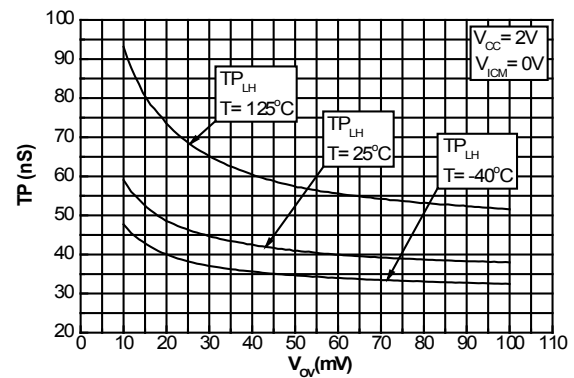
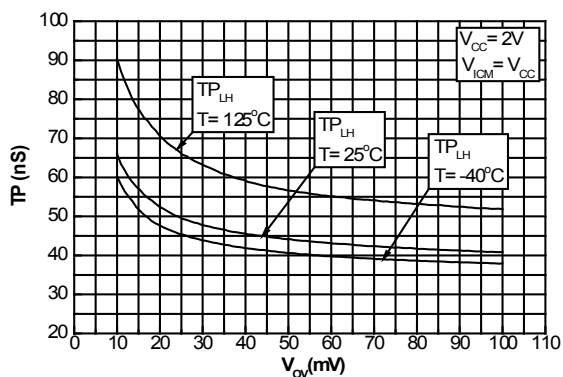
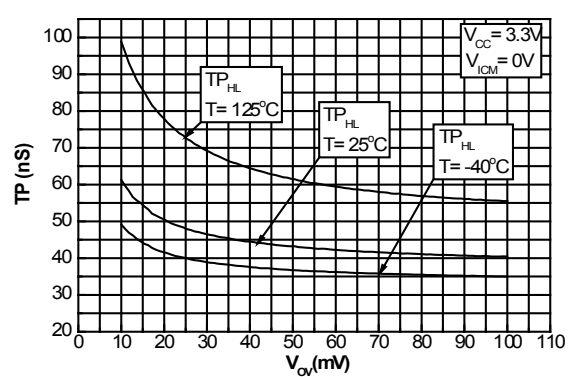
Figure 18. Propagation delay (HL) vs. overdrive at $V_{CC} = 3.3V$, $V_{ICM} = 0V$

Figure 19. Propagation delay (HL) vs. overdrive at V_{CC} = 3.3 V, Vicm = V_{CC}

Figure 20. Propagation delay (LH) vs. overdrive at V_{CC} = 3.3 V, Vicm = 0 V

Figure 21. Propagation delay (LH) vs. overdrive at V_{CC} = 3.3 V, Vicm = V_{CC}

Figure 22. Propagation delay (HL) vs. overdrive at V_{CC} = 5 V, Vicm = 0 V

Figure 23. Propagation delay (HL) vs. overdrive at V_{CC} = 5 V, Vicm = V_{CC}

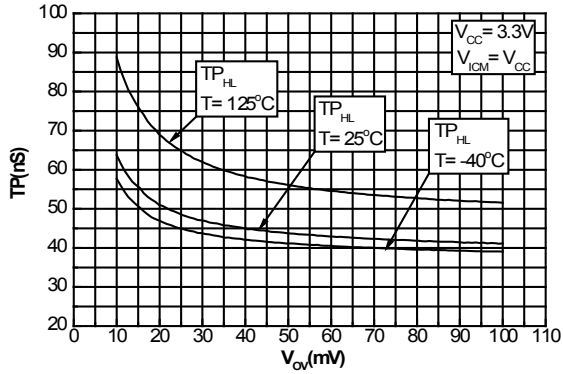
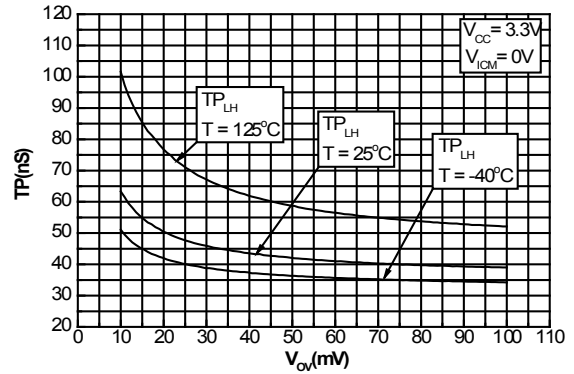
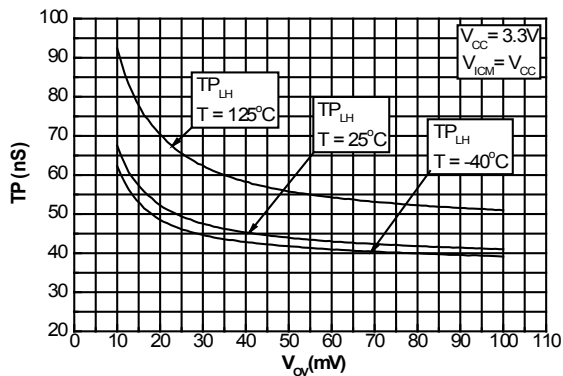
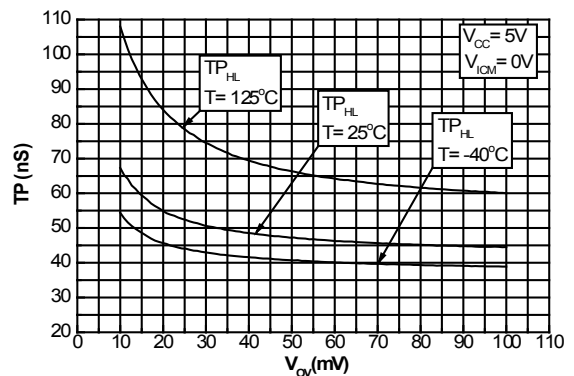
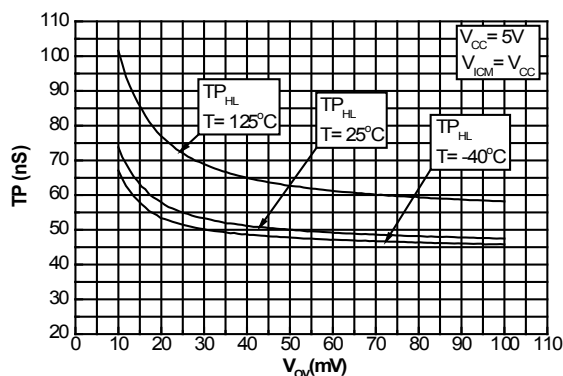
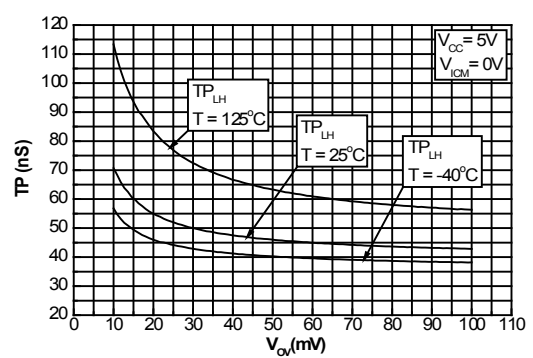
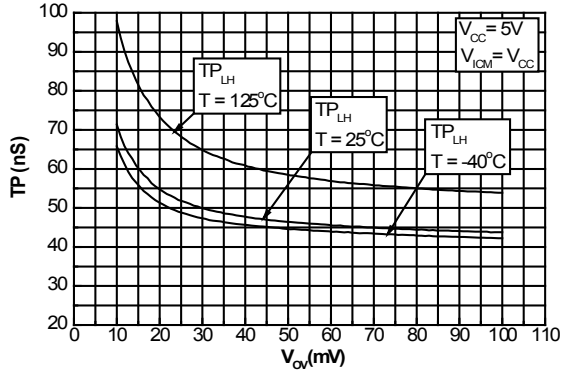
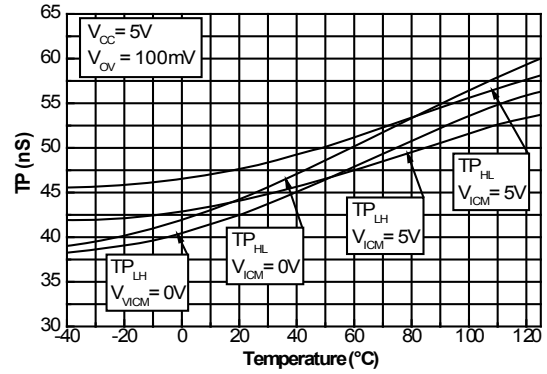
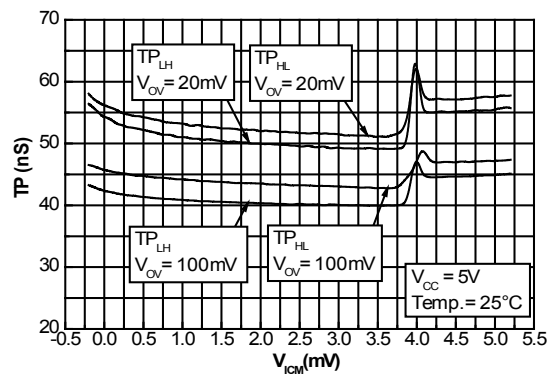
Figure 24. Propagation delay (LH) vs. overdrive at V_{CC} = 5 V, Vicm = 0 V

Figure 25. Propagation delay (LH) vs. overdrive at $V_{CC} = 5\text{ V}$, $V_{ICM} = V_{CC}$

Figure 26. Propagation delay vs. temperature, $V_{CC} = 5\text{ V}$, overdrive = 100 mV

Figure 27. Propagation delay vs. common mode voltage, $V_{CC} = 5\text{ V}$

4 Application recommendation

When high speed comparators are used, it is strongly recommended to place a capacitor as close as possible to the supply pins. Decoupling has two main advantages for this application: it helps to reduce electromagnetic interference and rejects the ripple that may appear on the output.

A bypass capacitor combination, composed of 100 nF in addition to 10 nF and 1 nF in parallel is recommended because it eliminates spikes on the supply line better than a single 100 nF capacitor. Each millimeter of the PCB track plays an important role. Bypass capacitors must be placed as close as possible to the comparator supply pin. The smallest value capacitor should be preferably placed closer to the supply pin.

In addition, important values of input impedance in series with parasitic PCB capacity and input comparator capacity create an additional RC filter. It generates an additional propagation delay.

For high speed signal applications, PCB must be designed with great care taking into consideration low resistive grounding, short tracks and quality SMD capacitors featuring low ESR. Bypass capacitor stores energy and provides a complementary energy tank when spikes occur on the power supply line. If the input signal frequency is far from the resonant frequency, impedance strongly increases and the capacitor loses bypassing capability. Placing different capacitors with different resonant frequencies allows a wide frequency bandwidth to be covered. It is also recommended to implement an unbroken ground plane with low inductance.

Figure 28. High speed layout recommendation

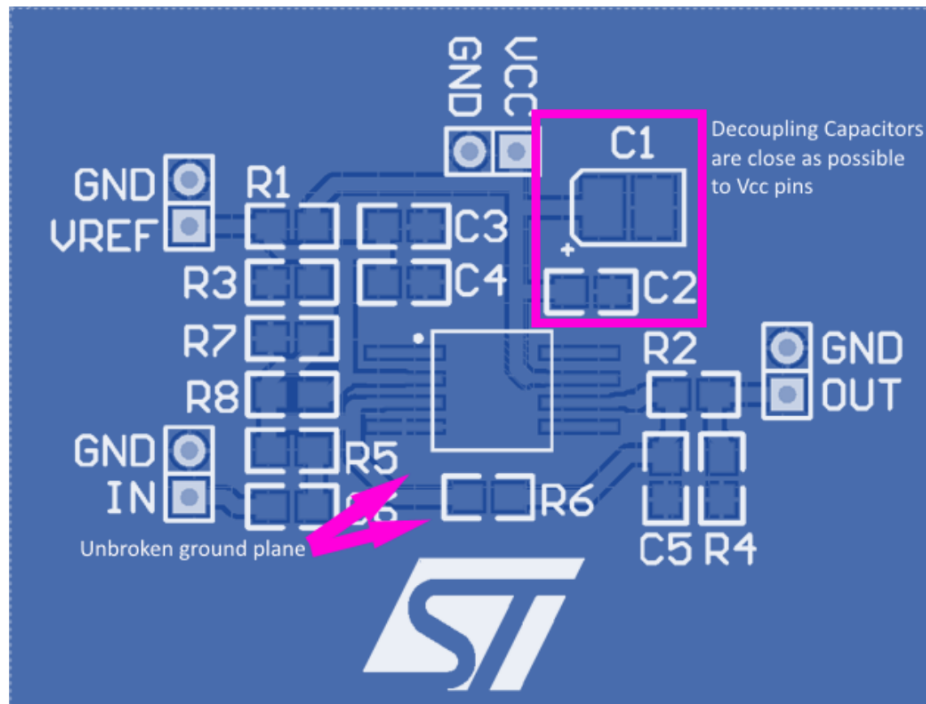

5 **Package information**

In order to meet environmental requirements, ST offers these devices in different grades of **ECOPACK** packages, depending on their level of environmental compliance. ECOPACK specifications, grade definitions and product status are available at: www.st.com. ECOPACK is an ST trademark.

5.1 SO-8 package information

Figure 29. SO-8 package outline

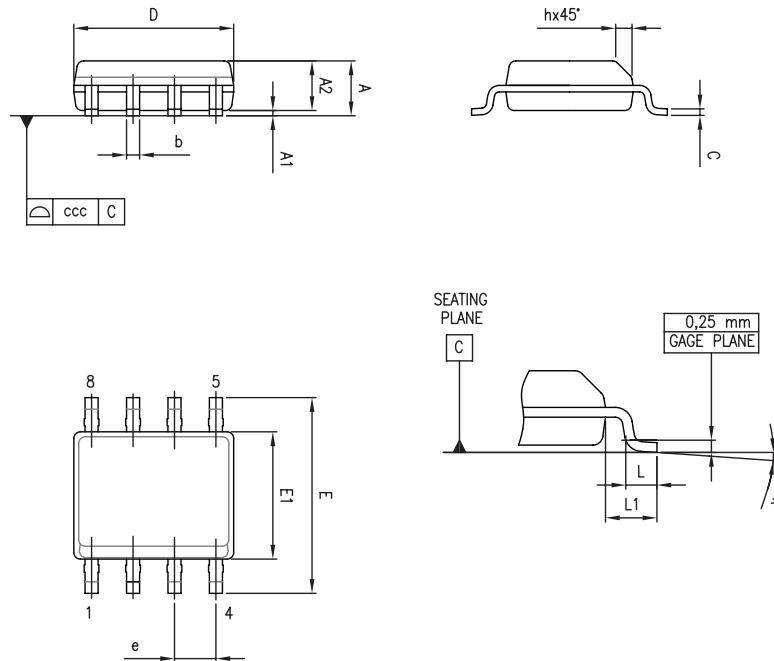

Table 6. SO-8 package mechanical data

Ref.	Dimensions					
	Millimeters			Inches		
	Min.	Typ.	Max.	Min.	Typ.	Max.
A			1.75			0.069
A1	0.10		0.25	0.04		0.010
A2	1.25			0.049		
b	0.28		0.48	0.011		0.019
c	0.17		0.23	0.007		0.010
D	4.80	4.90	5.00	0.189	0.193	0.197
E	5.80	6.00	6.20	0.228	0.236	0.244
E1	3.80	3.90	4.00	0.150	0.154	0.157
e		1.27			0.050	
h	0.25		0.50	0.010		0.020
L	0.40		1.27	0.016		0.050
L1		1.04			0.040	
k	0		8°	1°		8°
ccc			0.10			0.004

5.2 MiniSO8 package information

Figure 30. MiniSO8 package outline

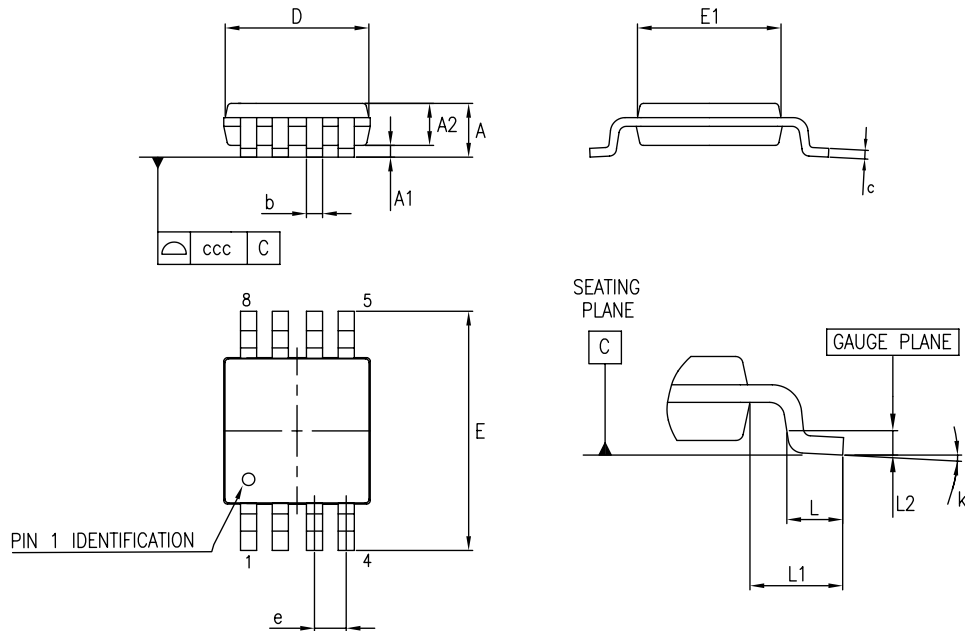

Table 7. MiniSO8 mechanical data

Dim.	Millimeters			Inches		
	Min.	Typ.	Max.	Min.	Typ.	Max.
A			1.1			0.043
A1	0		0.15	0		0.006
A2	0.75	0.85	0.95	0.03	0.033	0.037
b	0.22		0.4	0.009		0.016
c	0.08		0.23	0.003		0.009
D	2.8	3	3.2	0.11	0.118	0.126
E	4.65	4.9	5.15	0.183	0.193	0.203
E1	2.8	3	3.1	0.11	0.118	0.122
e		0.65			0.026	
L	0.4	0.6	0.8	0.016	0.024	0.031
L1		0.95			0.037	
L2		0.25			0.01	
k	0°		8°	0°		8°
ccc			0.1			0.004

6 Ordering information

Table 8. Ordering information

Order code	Temperature range	Package	Packing	Marking
TS3022IDT	-40 to 125 °C	SO-8	Tape and reel	3022I
TS3022IST		MiniSO-8		K521
TS3022IYST ⁽¹⁾				K520

1. Qualified and characterized according to AEC Q100 and Q003 or equivalent, advanced screening according to AEC Q001 and Q 002 or equivalent.

Revision history

Table 9. Document revision history

Date	Revision	Changes
29-Jan-2009	1	Initial release. The information contained in this datasheet was previously included in the TS3021-TS3022 datasheet (revision 4 dated October 2007). The single version (TS3021) and dual version (TS3022) have now been split into two separate datasheets. Refer to the TS3021 revision 5 for a complete history of changes.
25-Jun-2009	2	Modified ESD tolerances in Table 1: Absolute maximum ratings. In Table 3, Table 4 and Table 5: – modified VIO typical value and maximum limits. – modified IIB typical value. – modified ICC typical values and corrected maximum limits. – modified ISC typical values. – modified VOH and VOL typical values. – modified CMRR and SVR typical values. – modified TPHL and TPLH typical values. – modified note 3. – added note 4. Modified all curves.
07-Dec-2017	3	Updated features and applications in cover page. Updated Section 6: "Ordering information".
26-Mar-2019	4	Added new CDM parameter in Table 1. Absolute maximum ratings (AMR).
22-Oct-2020	5	Updated Table 8. Ordering information.

Contents

1	Absolute maximum ratings and operating conditions	2
2	Electrical characteristics	3
3	Electrical characteristic curves	6
4	Application recommendation	11
5	Package information	12
5.1	SO-8 package information	13
5.2	MiniSO8 package information	14
6	Ordering information	15
	Revision history	16

List of figures

Figure 1.	Current consumption vs. supply voltage ($V_{icm} = 0\text{ V}$, output high)	6
Figure 2.	Current consumption vs. supply voltage ($V_{icm} = V_{cc}$ output high)	6
Figure 3.	Current consumption vs. supply voltage ($V_{icm} = 0\text{ V}$, output low)	6
Figure 4.	Current consumption vs. supply voltage ($V_{icm} = V_{cc}$ output low)	6
Figure 5.	Output voltage vs. source current, $V_{cc} = 2\text{ V}$	6
Figure 6.	Output voltage vs. sink current, $V_{cc} = 2\text{ V}$	6
Figure 7.	Output voltage vs. source current, $V_{cc} = 3.3\text{ V}$	7
Figure 8.	Output voltage vs. sink current, $V_{cc} = 3.3\text{ V}$	7
Figure 9.	Output voltage vs. source current, $V_{cc} = 5\text{ V}$	7
Figure 10.	Output voltage vs. sink current, $V_{cc} = 5\text{ V}$	7
Figure 11.	Input offset voltage vs. temperature and common mode voltage	7
Figure 12.	Input bias current vs. temperature and input voltage	7
Figure 13.	Current consumption vs. commutation frequency	8
Figure 14.	Propagation delay (HL) vs. overdrive at $V_{cc} = 2\text{ V}$, $V_{icm} = 0\text{ V}$	8
Figure 15.	Propagation delay (HL) vs. overdrive at $V_{cc} = 2\text{ V}$, $V_{icm} = V_{cc}$	8
Figure 16.	Propagation delay (LH) vs. overdrive at $V_{cc} = 2\text{ V}$, $V_{icm} = 0\text{ V}$	8
Figure 17.	Propagation delay (LH) vs. overdrive at $V_{cc} = 2\text{ V}$, $V_{icm} = V_{cc}$	8
Figure 18.	Propagation delay (HL) vs. overdrive at $V_{cc} = 3.3\text{ V}$, $V_{icm} = 0\text{ V}$	8
Figure 19.	Propagation delay (HL) vs. overdrive at $V_{cc} = 3.3\text{ V}$, $V_{icm} = V_{cc}$	9
Figure 20.	Propagation delay (LH) vs. overdrive at $V_{cc} = 3.3\text{ V}$, $V_{icm} = 0\text{ V}$	9
Figure 21.	Propagation delay (LH) vs. overdrive at $V_{cc} = 3.3\text{ V}$, $V_{icm} = V_{cc}$	9
Figure 22.	Propagation delay (HL) vs. overdrive at $V_{cc} = 5\text{ V}$, $V_{icm} = 0\text{ V}$	9
Figure 23.	Propagation delay (HL) vs. overdrive at $V_{cc} = 5\text{ V}$, $V_{icm} = V_{cc}$	9
Figure 24.	Propagation delay (LH) vs. overdrive at $V_{cc} = 5\text{ V}$, $V_{icm} = 0\text{ V}$	9
Figure 25.	Propagation delay (LH) vs. overdrive at $V_{cc} = 5\text{ V}$, $V_{icm} = V_{cc}$	10
Figure 26.	Propagation delay vs. temperature, $V_{cc} = 5\text{ V}$, overdrive = 100 mV	10
Figure 27.	Propagation delay vs. common mode voltage, $V_{cc} = 5\text{ V}$	10
Figure 28.	High speed layout recommendation.	11
Figure 29.	SO-8 package outline	13
Figure 30.	MiniSO8 package outline	14

List of tables

Table 1.	Absolute maximum ratings (AMR)	2
Table 2.	Operating conditions	2
Table 3.	Electrical characteristics at $V_{CC+} = 2\text{ V}$, $V_{CC-} = 0\text{ V}$, $T_{amb} = 25\text{ }^{\circ}\text{C}$, and full V_{icm} range (unless otherwise specified)	3
Table 4.	Electrical characteristics at $V_{CC+} = 3.3\text{ V}$, $V_{CC-} = 0\text{ V}$, $T_{amb} = 25\text{ }^{\circ}\text{C}$, and full V_{icm} range (unless otherwise specified)	4
Table 5.	Electrical characteristics at $V_{CC} = 5\text{ V}$, $T_{amb} = 25\text{ }^{\circ}\text{C}$, and full V_{icm} range (unless otherwise specified)	5
Table 6.	SO-8 package mechanical data	13
Table 7.	MiniSO8 mechanical data	14
Table 8.	Ordering information.	15
Table 9.	Document revision history	16

IMPORTANT NOTICE – PLEASE READ CAREFULLY

STMicroelectronics NV and its subsidiaries (“ST”) reserve the right to make changes, corrections, enhancements, modifications, and improvements to ST products and/or to this document at any time without notice. Purchasers should obtain the latest relevant information on ST products before placing orders. ST products are sold pursuant to ST’s terms and conditions of sale in place at the time of order acknowledgement.

Purchasers are solely responsible for the choice, selection, and use of ST products and ST assumes no liability for application assistance or the design of Purchasers’ products.

No license, express or implied, to any intellectual property right is granted by ST herein.

Resale of ST products with provisions different from the information set forth herein shall void any warranty granted by ST for such product.

ST and the ST logo are trademarks of ST. For additional information about ST trademarks, please refer to www.st.com/trademarks. All other product or service names are the property of their respective owners.

Information in this document supersedes and replaces information previously supplied in any prior versions of this document.

© 2020 STMicroelectronics – All rights reserved