

# NCP5339

## Integrated Driver & MOSFETs

The NCP5339 integrates a MOSFET driver, high-side MOSFET and low-side MOSFET into a 6 mm x 6 mm 40-pin QFN package. The driver and MOSFETs have been optimized for high-current DC-DC buck power conversion applications. The NCP5339 integrated solution greatly reduce package parasitics and board space compared to a discrete component solution.

### Features

- 3-State 5 V PWM Logic
- Zero Current Detection for Improving Light Load Efficiency
- Internal Bootstrap Schottky Diode
- Undervoltage Lockout of VCIN
- Disable Pin Disables Both Driver Outputs
- Internal Thermal Warning / Thermal Shutdown Functionality
- These are Pb-free Devices

### Typical Applications

- Servers and Desktops
- Graphics Cards
- Telecom

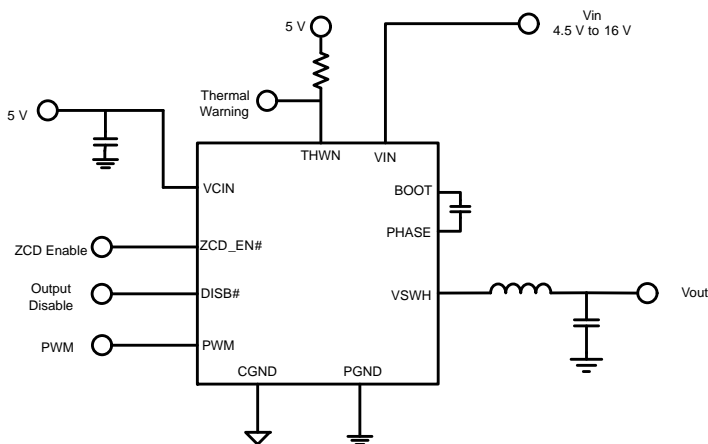
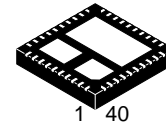

Figure 1. Application Schematic



**ON Semiconductor®**

[www.onsemi.com](http://www.onsemi.com)



QFN40 6x6, 0.5P  
CASE 485CM

### MARKING DIAGRAM

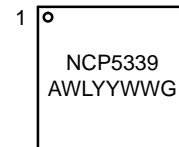

NCP5339 = Specific Device Code  
A = Assembly Location  
WL = Wafer Lot  
YY = Year  
WW = Work Week  
G = Pb-Free Package

### ORDERING INFORMATION

Device	Package	Shipping†
NCP5339MNTXG	QFN-40 (Pb-Free)	2500 / Tape & Reel

†For information on tape and reel specifications, including part orientation and tape sizes, please refer to our Tape and Reel Packaging Specification Brochure, BRD8011/D.



# NCP5339

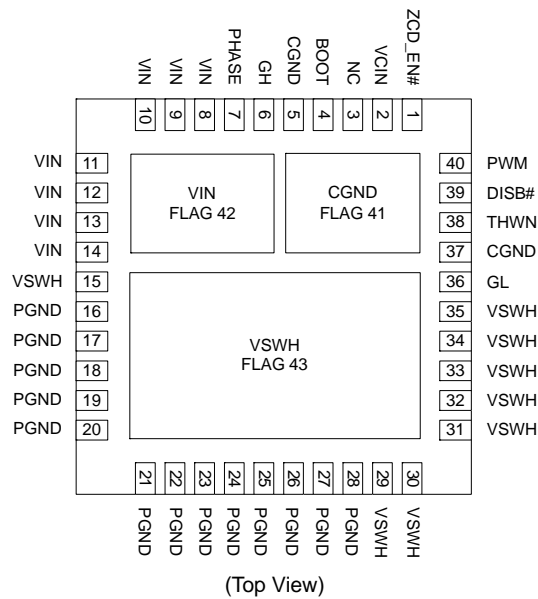

**Figure 3. Pin Connections**

**Table 1. PIN FUNCTION DESCRIPTION**

Pin No.	Pin Name	Description
1	ZCD_EN#	Enable Zero Current Detection. When the voltage on this pin is low, the NCP5339 will enter zero current detection mode. Otherwise, the NCP5339 will be in PWM mode. There is a 300 kΩ pull-up resistor to VCIN.
2	VCIN	Control Input Voltage. Provides power to the driver IC logic and power to the GL driver.
3	NC	No Connect. There is no connection to any IC die.
4	BOOT	Bootstrap Voltage. This provides power to the GH driver. Place a high frequency ceramic capacitor of 0.1 μF to 1.0 μF from this pin to PHASE.
5, 37, FLAG 41	CGND	Control Signal Ground
6	GH	High-Side FET Gate Access
7	PHASE	Connection to the source of the high-side MOSFET. Place a high frequency ceramic capacitor of 0.1 μF to 1.0 μF from this pin to BOOT pin.
8–14, FLAG 42	VIN	Input Voltage
15, 29–35, FLAG 43	VSWH	Switch Node Output
16–28	PGND	Power Ground
36	GL	Low-Side FET Gate Access
38	THWN	Thermal warning indicator. This is an open-drain output. When the temperature at the driver die reaches T <sub>THWN</sub> , this pin is pulled low. Driver operation is not disabled until the driver die temperature reaches T <sub>THDN</sub> . Driver operation is resumed once the driver die temperature falls below the T <sub>THDN</sub> hysteresis level.
39	DISB#	Output Disable Pin. When the voltage on this pin is low, GH and GL is pulled low.
40	PWM	PWM Drive Logic. This is a 3-state input: PWM = High → GH is high, GL is low. PWM = Mid → GH is low, GL goes low after t <sub>holdoff</sub> . PWM = Low → GH is low, GL is high (ZCD_EN# = High). GH is low, GL is high for t <sub>blank</sub> and then goes low when zero current is detected (ZCD_EN# = Low). There are internal PWM resistors that bias this pin to 2.2 V (mid-state) if the pin is left floating.

# NCP5339

**Table 2. ABSOLUTE MAXIMUM RATINGS** (All Signals Referenced to CGND unless noted otherwise)

Pin Symbol	Pin Name	Min	Max	Unit
VCIN	Control Input Voltage	-0.3	6.5	V
VIN	Power Input Voltage (Note 1)	-0.3	25 to PGND	V
BOOT	Bootstrap Voltage	-0.3 to VSWH	35 40 (< 50 ns) 6.5 to VSWH	V
VSWH	Switch Node Output (Note 1)	-0.3 to PGND -5 to PGND (< 10 ns)	25 to PGND 30 to PGND (< 10 ns)	V
GH	High-Side FET Gate Access	-0.3 to VSWH	6.5 to VSWH	V
GL	Low-Side FET Gate Access	-0.3	6.5	V
ZCD_EN#	Zero Current Detection	-0.3	6.5	V
PWM	PWM Drive Logic	-0.3	6.5	V
DISB#	Output Disable	-0.3	6.5	V
THWN	Thermal Warning	-0.3	6.5	V
Continuous Output Current	Output Current, F <sub>sw</sub> = 300 kHz, V <sub>IN</sub> = 12 V, V <sub>OUT</sub> = 1.2 V (Note 2)	-	50	A
Peak Output Current (Note 3)	Output Current, F <sub>sw</sub> = 300 kHz, V <sub>IN</sub> = 12 V, V <sub>OUT</sub> = 1.2 V (Note 2)	-	80	A

Stresses exceeding those listed in the Maximum Ratings table may damage the device. If any of these limits are exceeded, device functionality should not be assumed, damage may occur and reliability may be affected.

1. During switching of the MOSFETs, high transient voltages can appear on these pins. It is important to keep these transients within the Maximum Ratings range.
2. Output current ratings are based on using a 3.0" x 3.0" PCB, 8 layers, board design, T<sub>A</sub> = 25°C, natural convection.
3. Peak output current is applied for 10 ms.

NOTE: This device is ESD sensitive. Use standard ESD precautions when handling.

**Table 3. THERMAL CHARACTERISTICS**

Parameter	Symbol	Value	Unit
Thermal Resistance, Junction-to-Ambient (Note 4)	$\theta_{JA}$	24.6	°C/W
Thermal Characterization Parameter, Junction-to-Board (Note 4)	$\psi_{JB}$	0.3	°C/W
Thermal Characterization Parameter, Junction-to-Top (Note 4)	$\psi_{JC}$	0.5	°C/W
Operating Junction Temperature Range	T <sub>J</sub>	-40 to 150	°C
Storage Temperature Range	T <sub>S</sub>	-55 to 150	°C
Moisture Sensitivity Level	MSL	3	

4. JESD51-7 board (2s2p, 1 oz. Cu thickness), 0 LFM.

**Table 4. OPERATING RANGES**

Rating	Symbol	Min	Typ	Max	Unit
Control Input Voltage	VCIN	4.5	5	5.5	V
Input Voltage	VIN	4.5	12	16	V

Functional operation above the stresses listed in the Recommended Operating Ranges is not implied. Extended exposure to stresses beyond the Recommended Operating Ranges limits may affect device reliability.

# NCP5339

**Table 5. ELECTRICAL CHARACTERISTICS**

(VCIN = 5 V, VIN = 12 V, TA = -40°C to +125°C, unless otherwise noted.)

Parameter	Symbol	Condition	Min	Typ	Max	Unit
<b>SUPPLY CURRENT</b>						
VCIN Current (normal mode)	–	DISB# = 5 V, PWM = switching (0 V to 5 V), FSW = 400 kHz	–	18	30	mA
VCIN Current (shutdown mode)	–	DISB# = GND, ZCD_EN# = VCIN	–	1	–	μA
<b>UNDERVOLTAGE LOCKOUT (VCIN)</b>						
UVLO Rising	V <sub>UVLO</sub>	VCIN rising	3.8	4.35	4.5	V
UVLO Hysteresis	HYS <sub>UVLO</sub>	UVLO rising threshold – UVLO falling threshold	150	200	250	mV
<b>BOOTSTRAP DIODE</b>						
Forward Voltage	–	Forward bias current = 2 mA	0.1	0.4	0.6	V
<b>PWM INPUT</b>						
PWM Input Voltage High	V <sub>PWM_HI</sub>		3.7	–	–	V
PWM Input Voltage Mid-State	V <sub>PWM_MID</sub>		1.3	–	3.0	V
PWM Input Voltage Low	V <sub>PWM_LO</sub>		–	–	0.7	V
Tri-State Shutdown Holdoff Time	t <sub>holdoff</sub>			250		ns
PWM Input Resistance	–			63		kΩ
PWM Input Bias Voltage	–			2.2		V
<b>OUTPUT DISABLE</b>						
Output Disable Input Voltage High	V <sub>DISB#_HI</sub>		2.0	–	–	V
Output Disable Input Voltage Low	V <sub>DISB#_LO</sub>		–	–	0.8	V
Output Disable Hysteresis	HYS <sub>DISB#</sub>	V <sub>DISB#_HI</sub> – V <sub>DISB#_LO</sub>	–	500	–	mV
Enable Delay Time (Note 5)	–	DISB# rising, PWM = 0 V, GL rising to 10%	–	25	–	μs
Output Disable Propagation Delay	–	DISB# falling, PWM = 0 V, GL falling to 90%	–	20	40	ns
<b>ZERO CROSS DETECT</b>						
Zero Cross Detect High	V <sub>ZCD_EN#_HI</sub>		2.0	–	–	V
Zero Cross Detect Low	V <sub>ZCD_EN#_LO</sub>		–	–	0.8	V
Zero Cross Detect Threshold	–	ZCD_EN# = 0 V	–	–6	–	mV
ZCD Blanking	t <sub>blank</sub>		–	250	–	ns
<b>THERMAL WARNING/SHUTDOWN</b>						
Thermal Warning Temperature (Note 5)	T <sub>THWN</sub>	Temperature at driver IC	–	150	–	°C
Thermal Warning Hysteresis (Note 5)	HYS <sub>THWN</sub>		–	15	–	°C
Thermal Shutdown Temperature (Note 5)	T <sub>THSD</sub>	Temperature at driver IC	–	180	–	°C
Thermal Shutdown Hysteresis (Note 5)	HYS <sub>THSD</sub>		–	25	–	°C

Product parametric performance is indicated in the Electrical Characteristics for the listed test conditions, unless otherwise noted. Product performance may not be indicated by the Electrical Characteristics if operated under different conditions.

5. Guaranteed by design and/or characterization. This parameter is not tested in production.

TYPICAL CHARACTERISTICS

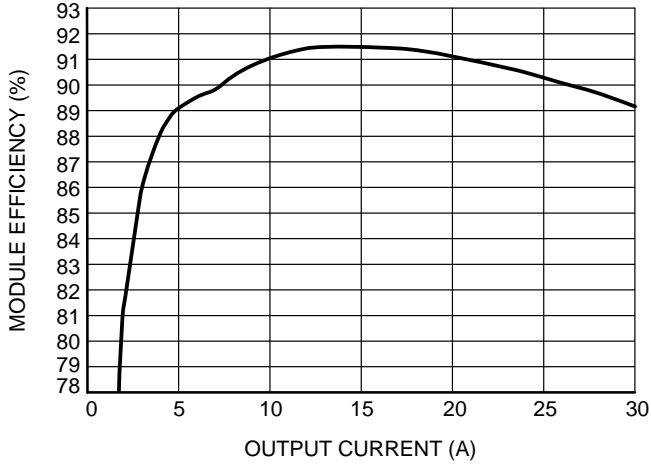

Figure 4. Module Efficiency vs. Current ( $V_{in} = 12\text{ V}$ ,  $V_{out} = 1.2\text{ V}$ , Natural Air Convection, Inductor =  $0.15\ \mu\text{H}$ , Output measured at VSW)

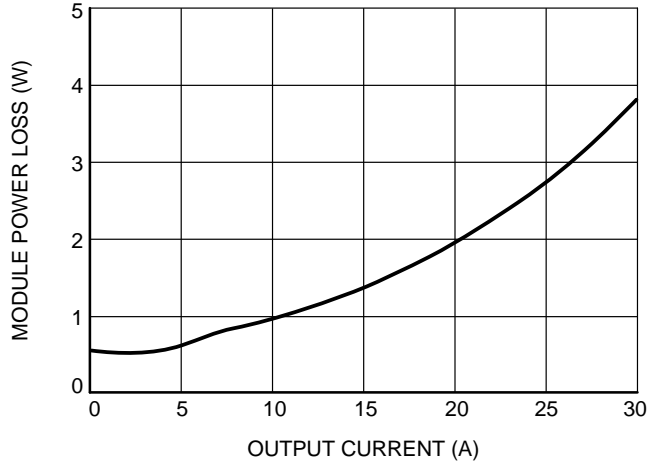

Figure 5. Module Power Loss vs. Current ( $V_{in} = 12\text{ V}$ ,  $V_{out} = 1.2\text{ V}$ , Natural Air Convection)

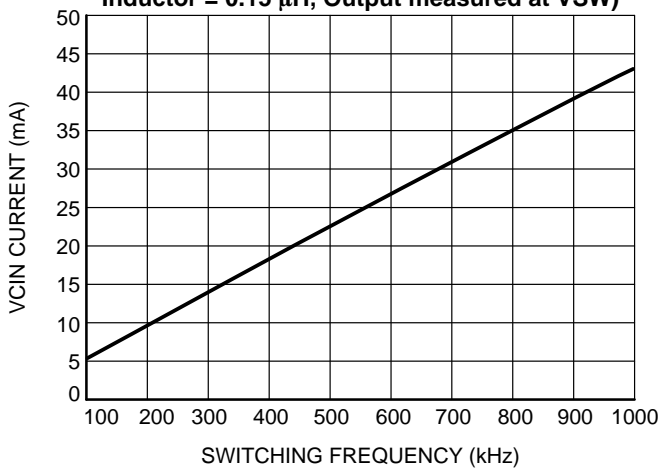

Figure 6. Driver Supply Current vs. Frequency ( $V_{CIN} = 5\text{ V}$ ,  $T_a = 25^\circ\text{C}$ )

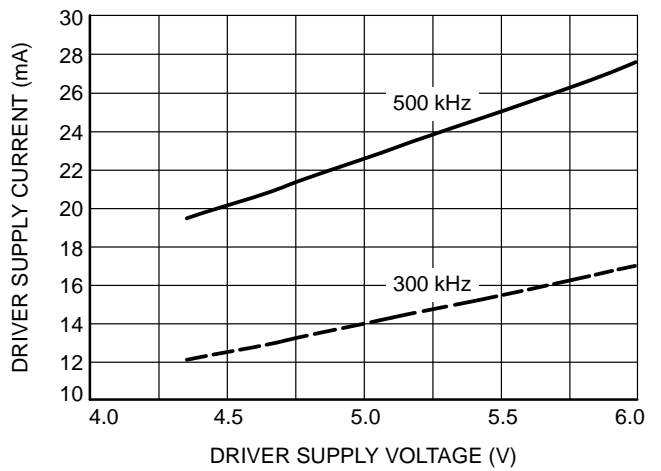

Figure 7. Driver Supply Current vs. Driver Supply Voltage ( $T_a = 25^\circ\text{C}$ )

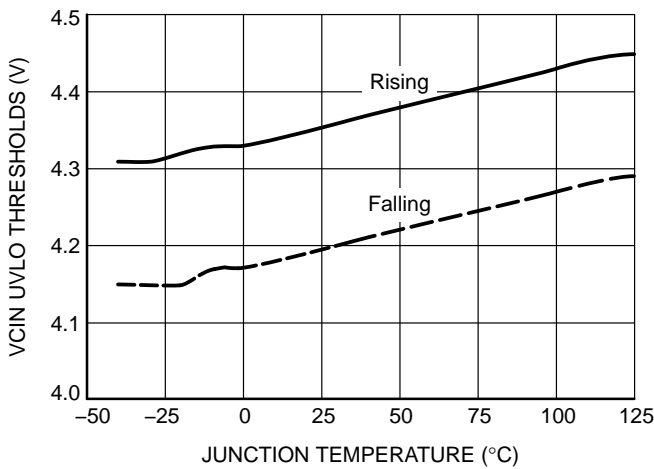

Figure 8. VCIN UVLO vs. Temperature ( $V_{CIN} = 5\text{ V}$ ,  $T_a = 25^\circ\text{C}$ )

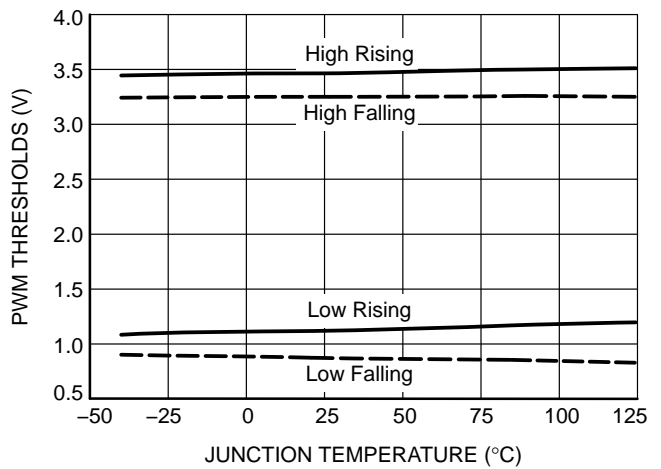

Figure 9. PWM Thresholds vs. Temperature ( $V_{CIN} = 5\text{ V}$ ,  $T_a = 25^\circ\text{C}$ )

TYPICAL CHARACTERISTICS

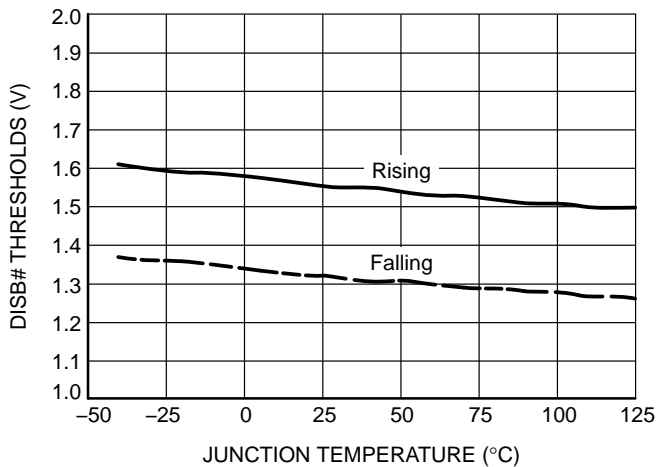

Figure 10. DISB# Threshold vs. Temperature (VCIN = 5 V, Ta = 25°C)

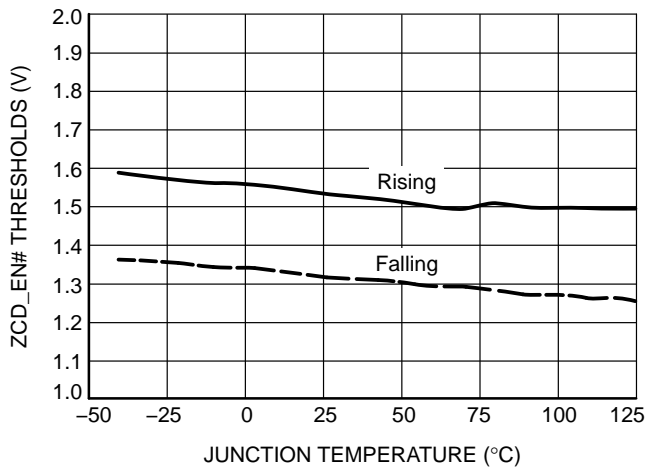

Figure 11. ZCD\_EN# Threshold vs. Temperature (VCIN = 5 V, Ta = 25°C)

## APPLICATIONS INFORMATION

**Theory of Operation**

The NCP5339 is an integrated driver and MOSFET module designed for use in a synchronous buck converter topology. It consists of a MOSFET driver die and two MOSFET dies, one acting as the control MOSFET (high-side FET) and the other acting as the synchronous MOSFET (low-side FET). A single PWM input signal is all that is required to properly drive the high-side and low-side MOSFETs.

**VCIN Undervoltage Lockout (UVLO)**

The VCIN pin is monitored by an Undervoltage Lockout circuit. While VCIN is below UVLO Rising threshold (4.35 V, typical), the outputs of the MOSFET driver, GH and GL, are floating. The internal pull-down resistors connected to GH and GL keep the MOSFETs in the off-state. When VCIN is greater than UVLO Rising threshold, the driver can be enabled by pulling DISB# high. There is a hysteresis of 200 mV (typical) on VCIN UVLO.

**Enabling/Disabling the Driver (DISB#)**

The DISB# pin is used to disable the GH and GL outputs of the MOSFET driver. When DISB# is low, the driver is disabled, pulling both gates of the MOSFETs low. This prevents power transfer from VIN to the output. The driver is enabled by pulling DISB# into a logic-high state (as long as VCIN is greater than UVLO Rising threshold). When the driver is enabled, the states of GH and GL are determined by the signal on the PWM pin. See Table 6 for the UVLO/DISB# logic table.

Every time DISB# changes from a low-state to a high-state, the driver undergoes an auto-calibration cycle for the zero current detect threshold. This auto-calibration cycle typically takes 25  $\mu$ s to complete. The driver outputs will not respond to the PWM input signal until the auto-calibration cycle is completed.

**Table 6. UVLO/DISB# Logic Table**

UVLO	DISB#	GH, GL Outputs
L	X	GH = Low, GL = Low
H	L	GH = Low, GL = Low
H	H	Normal PWM Operation (See X)
H	Open	GH = Low, GL = Low

**Low-Side Driver**

The low-side driver is designed to drive a ground-referenced low-RDS(on) N-Channel MOSFET, the synchronous MOSFET in a buck converter. The voltage supply for the low-side driver is internally connected to the VCIN and CGND pins. The driver turns on the low-side MOSFET with the charge stored in the VCIN capacitor. So, it is important to place the VCIN capacitor close to the VCIN

and CGND pins to minimize the parasitics in this loop. A multi-layer ceramic capacitor greater than 1  $\mu$ F should be used.

**High-Side Driver**

The high-side driver is designed to drive a floating low-RDS(on) N-channel MOSFET, the control MOSFET in a buck converter. The gate voltage for the high-side driver is developed by a bootstrap circuit referenced to the VSWH pin (switch node).

The bootstrap circuit is comprised of the internal Schottky diode and an external capacitor. When the NCP5339 is starting up, the VSWH pin is held at ground, allowing the bootstrap capacitor to charge up to VCIN through the bootstrap diode (See Figure 1). When the PWM input is driven high, the high-side driver will turn on the high-side MOSFET using the stored charge of the bootstrap capacitor. As the high-side MOSFET turns on, the VSWH pin rises. When the high-side MOSFET is fully turned on, the switch node will settle to VIN and the BST pin will settle to VIN + VCIN (excluding parasitic ringing).

**Bootstrap Circuit**

The bootstrap circuit relies on an external charge-storage capacitor (C<sub>BST</sub>) and an integrated diode to provide current to the high-side driver. A multi-layer ceramic capacitor with a value greater than 100 nF should be used as the bootstrap capacitor.

**Overlap Protection Circuit**

It is important to avoid cross-conduction of the two MOSFETs, which could result in a decrease in the power conversion efficiency or damage to the device.

The NCP5339 prevents cross-conduction by monitoring the status of the MOSFETs and applying the appropriate amount of non-overlap time (the time between the turn-off of one MOSFET and the turn-on of the other MOSFET). See Figure 12.

When the PWM input is driven high, the gate of the low-side MOSFET (GL) goes low after a propagation delay, t<sub>pdGL</sub>. The time it takes for the low-side MOSFET to turn off is dependent on the total charge on the low-side MOSFET gate. The NCP5339 monitors the pre-driver voltage of both MOSFETs and VSWH to determine the conduction status of the MOSFETs. Once the low-side MOSFET is turned off, an internal timer will delay the turn-on of the high-side MOSFET, t<sub>pdhGH</sub>.

Likewise, when the PWM input pin goes low, the gate of the high-side MOSFET (GH) goes low after a propagation delay, t<sub>pdGH</sub>. The time to turn off the high-side MOSFET is dependent on the total gate charge of the high-side MOSFET. A timer is triggered once the high-side MOSFET stops conducting, to delay the turn-on of the low-side MOSFET, t<sub>pdhGL</sub>.



# NCP5339

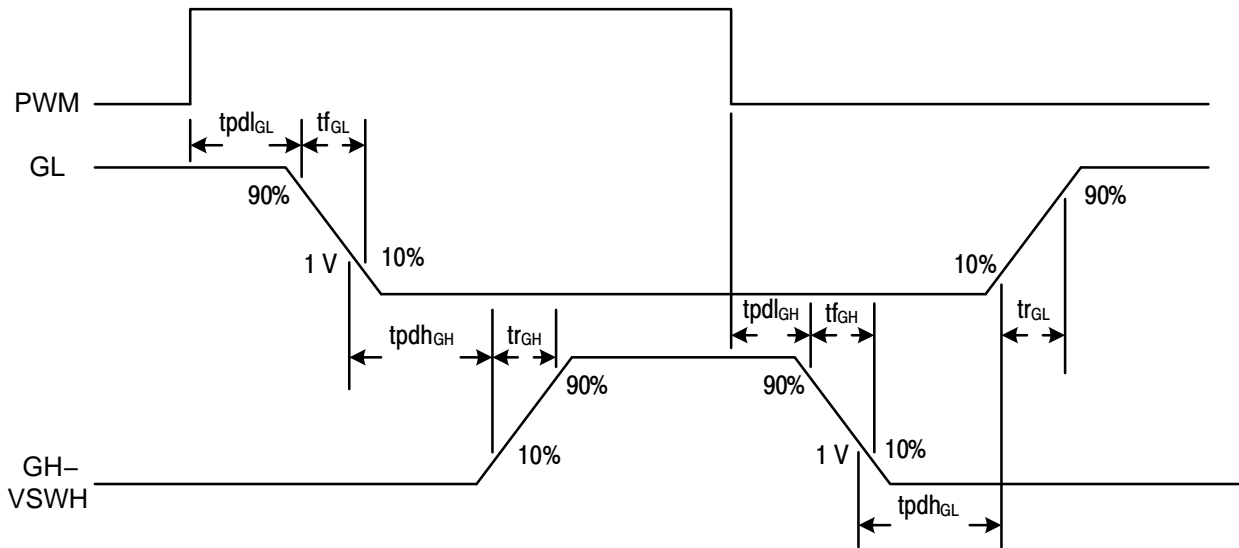

Figure 12. MOSFET Gate Timing Diagram

### PWM Mid-State

The NCP5339 can be placed into a high-impedance state, where both high-side and low-side MOSFETs are in the off-state. This state is commonly used in multi-phase applications that allow phase shedding. A phase can be turned off by placing the NCP5339 from that phase into PWM mid-state. The phase can quickly be turned back on by having PWM exit mid-state. When the voltage on PWM is within the  $V_{PWM\_MID}$  voltage range, both GH and GL are pulled low after a hold-off time (See Figure 13).

- When transitioning from a PWM low state to mid-state, GL goes from high to low after  $t_{holdoff}$ . GH is already low due to the prior PWM low state.
- When transitioning from a PWM high state to mid-state, GH goes from high to low without delay. After GH is pulled low, GL goes high for  $t_{holdoff}$ . There are internal resistors at the PWM input that biases the voltage on PWM to be at mid-state when the voltage at the pin is otherwise floating.

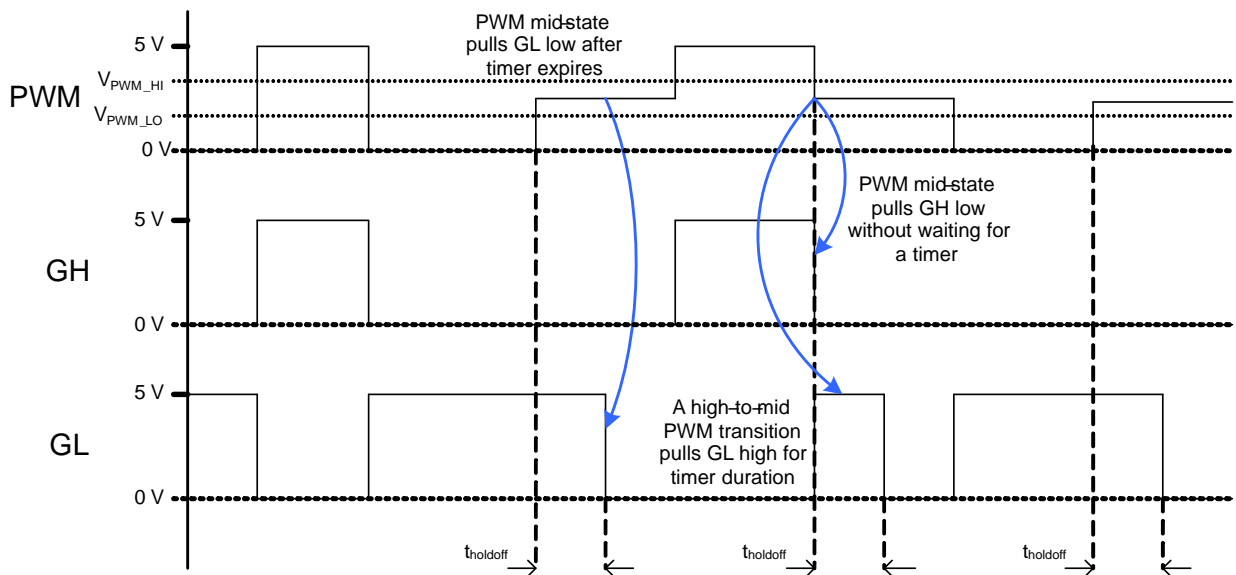

Figure 13. PWM Tri-State Behavior

**Zero Current Detect**

When operating under light load conditions, the current ripple through the inductor can cause a buck converter to partially operate with negative current. This can have a noticeable impact on converter efficiency as the negative current discharges the output capacitors. The zero current detect feature in the NCP5339 automatically turns off the low-side MOSFET before the inductor current goes negative. This causes the converter to operate under discontinuous conduction mode and improves the efficiency during light load conditions.

The ZCD\_EN# pin is a logic input pin with an active 300 kΩ pull-up resistance to VCIN.

When ZCD\_EN# is set high, the NCP5339 will operate in normal PWM mode.

When ZCD\_EN# is set low, zero cross detect (ZCD) is enabled, see Figure 14. The high-side driver responds to PWM in the same manner as in normal PWM mode. When PWM is high, GH goes high after the non-overlap delay. When PWM is low, GL goes high after the non-overlap delay, and stays high for the duration of the ZCD blanking timer. Once this timer expires, VSWH is monitored for zero cross detection, pulling GL low after VSWH is detected to be at or above the ZCD threshold voltage.

The ZCD threshold undergoes an auto-calibration cycle every time DISB# is brought from low to high. This auto-calibration cycle typically takes 25 μs to complete. During the auto-calibration cycle, GH and GL are pulled low and do not respond to PWM signals.

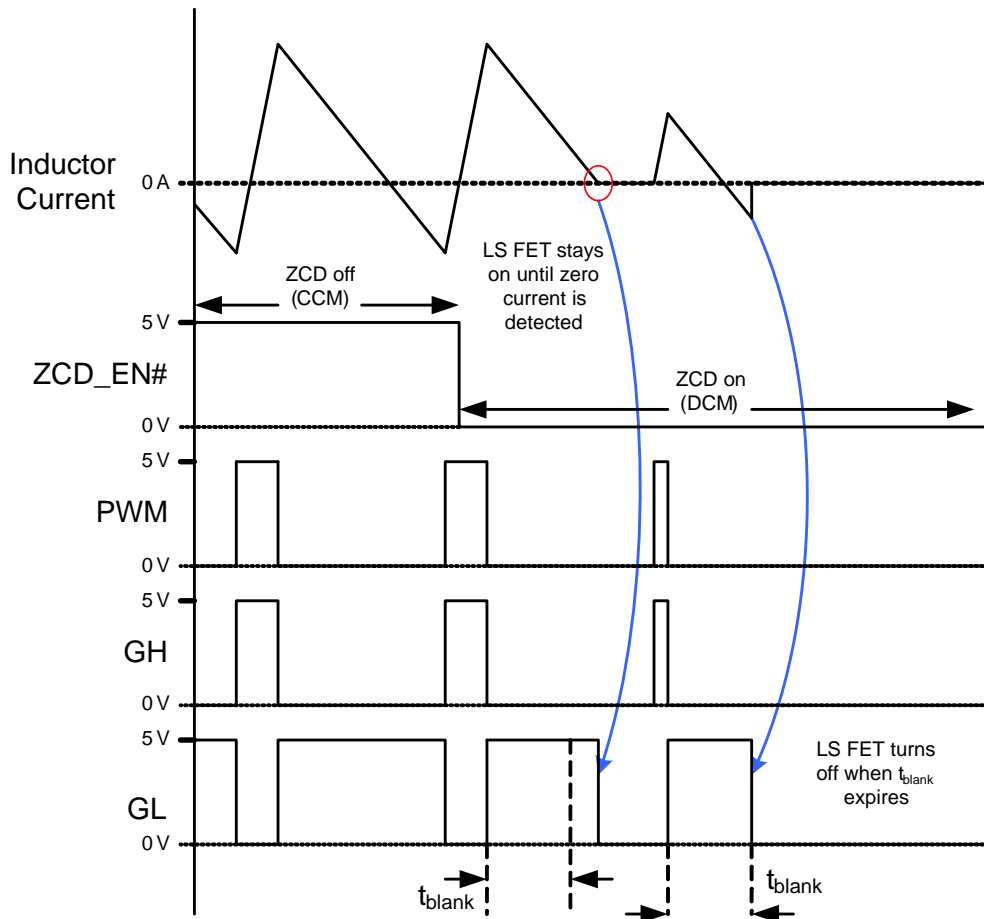
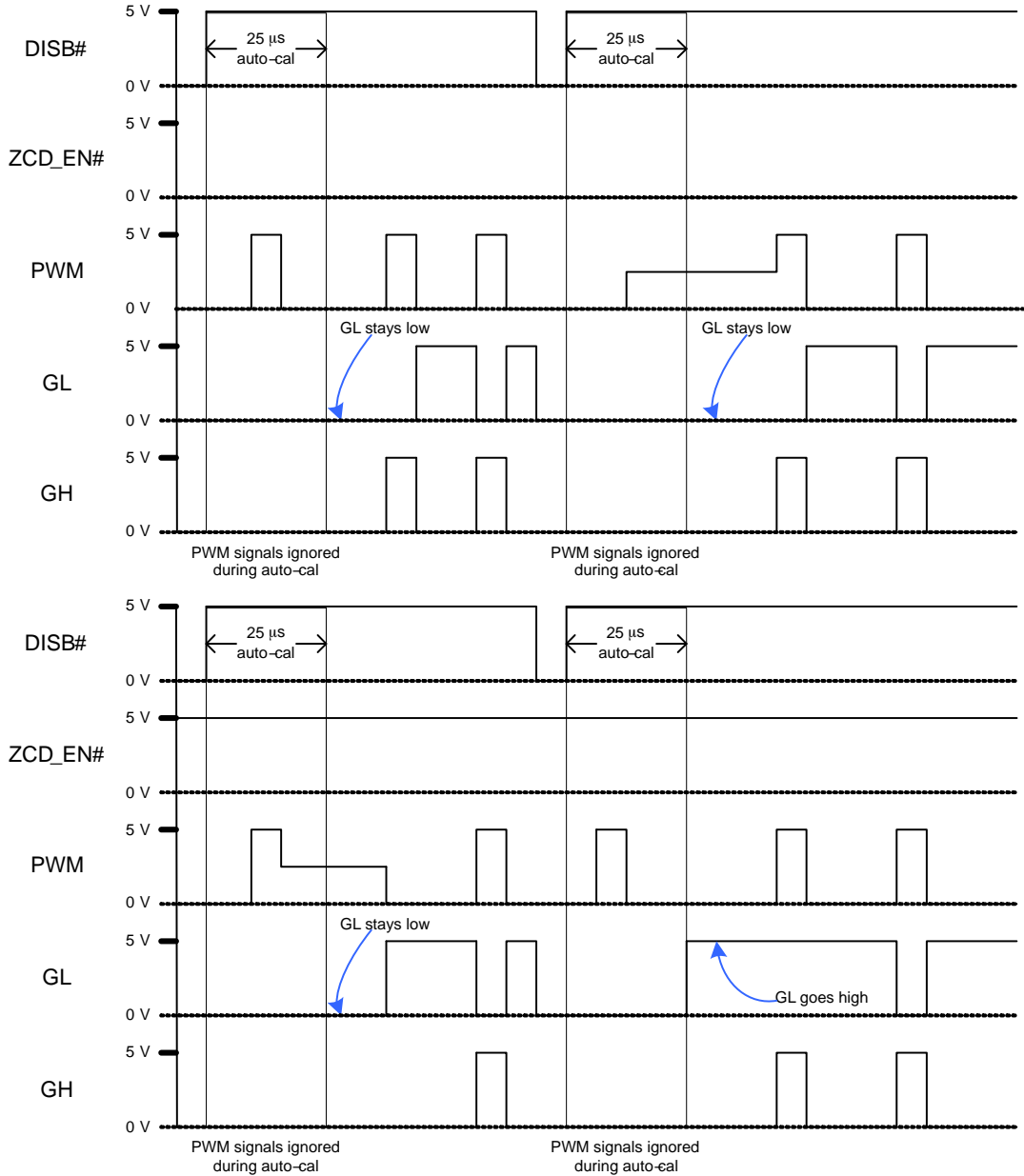

Figure 14. Zero Current Detect Behavior

**Prebias Startup**

There are conditions that could allow a converter to start up when there is a pre-existing voltage at the output. Turning off a converter and then quickly turning it back on is an example of this. There are controllers that, when a prebias startup is recognized, will want to start the power stage without discharging the output capacitors. To allow for a prebias startup, the GL control of the NCP5339 has the following behavior when it is first enabled:

1. If on startup, ZCD\_EN# is low and PWM is low or mid, GL is low. Need a PWM transition (mid-to-high-to-low, low-to-high-to-low or mid-to-low) to get GL to go high.
2. If on startup, ZCD\_EN# is high and PWM is mid, GL is low. Need a PWM transition to low to get GL to go high.
3. If on startup, ZCD\_EN# is high and PWM is low, GL is high. No prebias condition.



**Figure 15. Prebias Startup**  
 (Top figure: ZCD\_EN# = High, Bottom figure: ZCD\_EN# = Low)

**Thermal Warning / Thermal Shutdown**

The THWN pin is an open-drain output. The temperature sensor is on the die of the MOSFET driver. When the temperature of the driver reaches 150°C, the THWN pin is pulled low indicating a thermal warning. At this point, the part continues to function normally. When the temperature

drops below 135°C, the THWN pin is released. If the driver temperature exceeds 180°C, the part enters thermal shutdown and turns off both MOSFETs. Once the temperature falls below 155°C, the part resumes normal operation. The THWN pin has a maximum current capability of 30 mA.

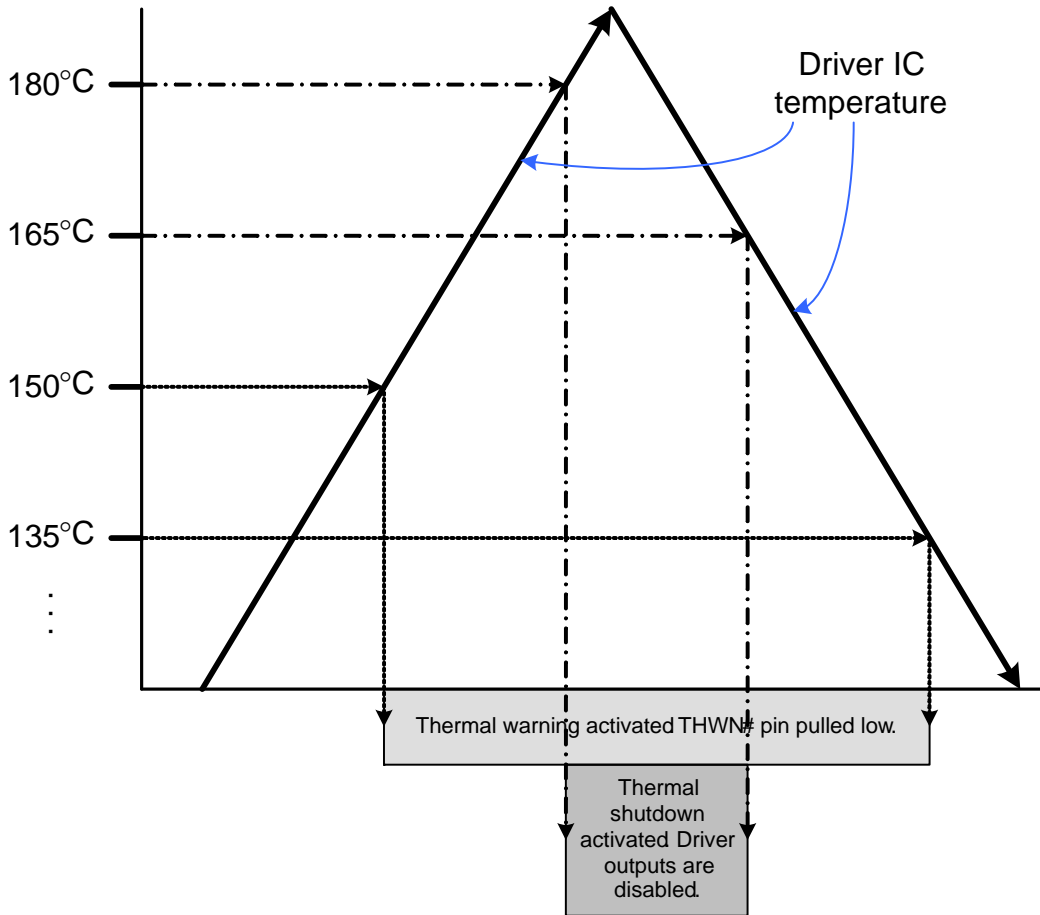
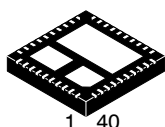

Figure 16. Thermal Warning/Thermal Shutdown Behavior

# MECHANICAL CASE OUTLINE

## PACKAGE DIMENSIONS

ON Semiconductor®



1 40  
SCALE 2:1

QFN40 6x6, 0.5P  
CASE 485CM  
ISSUE O

DATE 05 JUN 2012

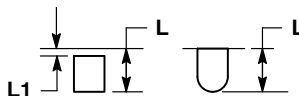
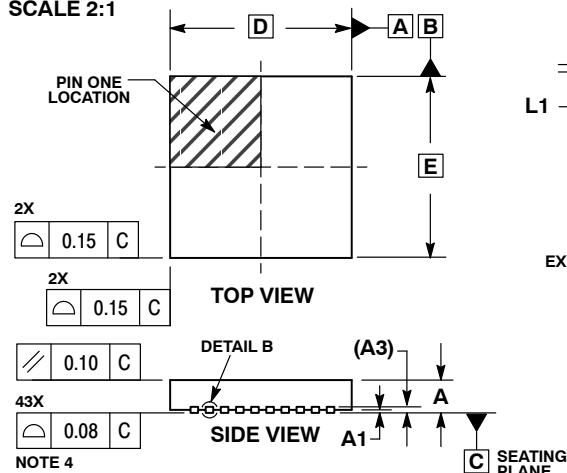

DETAIL A  
ALTERNATE  
CONSTRUCTIONS

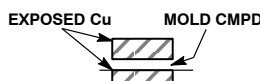

DETAIL B  
ALTERNATE  
CONSTRUCTION

NOTES:

1. DIMENSIONING AND TOLERANCING PER ASME Y14.5M, 1994.
2. CONTROLLING DIMENSIONS: MILLIMETERS.
3. DIMENSION b APPLIES TO PLATED TERMINAL AND IS MEASURED BETWEEN 0.15 AND 0.30mm FROM TERMINAL
4. COPLANARITY APPLIES TO THE EXPOSED PAD AS WELL AS THE TERMINALS.
5. POSITIONAL TOLERANCE APPLIES TO ALL THREE EXPOSED PADS.

MILLIMETERS		
DIM	MIN	MAX
A	0.80	1.00
A1	---	0.05
A3	0.20	REF
b	0.18	0.30
D	6.00	BSC
D2	2.30	2.50
D3	1.40	1.60
E	6.00	BSC
E2	4.30	4.50
E3	1.90	2.10
E4	1.64	1.84
e	0.50	BSC
G	2.20	BSC
K	0.20	---
L	0.30	0.50
L1	---	0.15

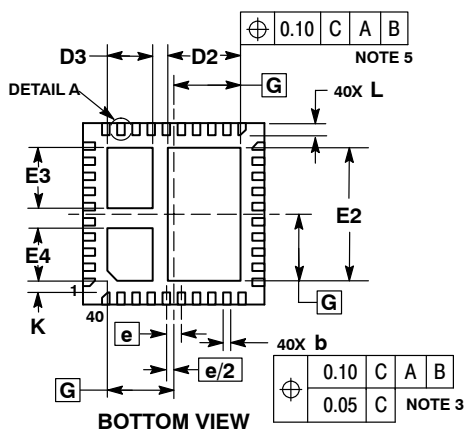

**SOLDERING FOOTPRINT**

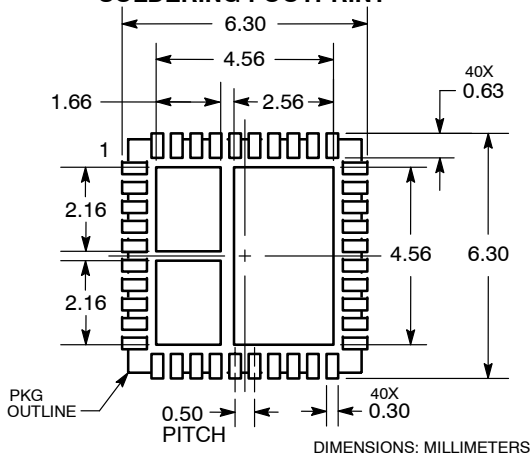

**GENERIC MARKING DIAGRAM\***

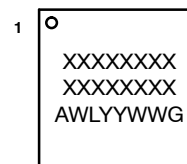

- XXXXX = Specific Device Code
- A = Assembly Location
- WL = Wafer Lot
- YY = Year
- WW = Work Week
- G = Pb-Free Package

\*This information is generic. Please refer to device data sheet for actual part marking.  
Pb-Free indicator, "G" or microdot "▪", may or may not be present.

<b>DOCUMENT NUMBER:</b>	<b>98AON81111E</b>	Electronic versions are uncontrolled except when accessed directly from the Document Repository. Printed versions are uncontrolled except when stamped "CONTROLLED COPY" in red.
<b>DESCRIPTION:</b>	<b>QFN40 6x6, 0.5P</b>	<b>PAGE 1 OF 1</b>

ON Semiconductor and ON are trademarks of Semiconductor Components Industries, LLC dba ON Semiconductor or its subsidiaries in the United States and/or other countries. ON Semiconductor reserves the right to make changes without further notice to any products herein. ON Semiconductor makes no warranty, representation or guarantee regarding the suitability of its products for any particular purpose, nor does ON Semiconductor assume any liability arising out of the application or use of any product or circuit, and specifically disclaims any and all liability, including without limitation special, consequential or incidental damages. ON Semiconductor does not convey any license under its patent rights nor the rights of others.

**onsemi**, **Onsemi**, and other names, marks, and brands are registered and/or common law trademarks of Semiconductor Components Industries, LLC dba "**onsemi**" or its affiliates and/or subsidiaries in the United States and/or other countries. **onsemi** owns the rights to a number of patents, trademarks, copyrights, trade secrets, and other intellectual property. A listing of **onsemi**'s product/patent coverage may be accessed at [www.onsemi.com/site/pdf/Patent-Marking.pdf](http://www.onsemi.com/site/pdf/Patent-Marking.pdf). **onsemi** reserves the right to make changes at any time to any products or information herein, without notice. The information herein is provided "as-is" and **onsemi** makes no warranty, representation or guarantee regarding the accuracy of the information, product features, availability, functionality, or suitability of its products for any particular purpose, nor does **onsemi** assume any liability arising out of the application or use of any product or circuit, and specifically disclaims any and all liability, including without limitation special, consequential or incidental damages. Buyer is responsible for its products and applications using **onsemi** products, including compliance with all laws, regulations and safety requirements or standards, regardless of any support or applications information provided by **onsemi**. "Typical" parameters which may be provided in **onsemi** data sheets and/or specifications can and do vary in different applications and actual performance may vary over time. All operating parameters, including "Typicals" must be validated for each customer application by customer's technical experts. **onsemi** does not convey any license under any of its intellectual property rights nor the rights of others. **onsemi** products are not designed, intended, or authorized for use as a critical component in life support systems or any FDA Class 3 medical devices or medical devices with a same or similar classification in a foreign jurisdiction or any devices intended for implantation in the human body. Should Buyer purchase or use **onsemi** products for any such unintended or unauthorized application, Buyer shall indemnify and hold **onsemi** and its officers, employees, subsidiaries, affiliates, and distributors harmless against all claims, costs, damages, and expenses, and reasonable attorney fees arising out of, directly or indirectly, any claim of personal injury or death associated with such unintended or unauthorized use, even if such claim alleges that **onsemi** was negligent regarding the design or manufacture of the part. **onsemi** is an Equal Opportunity/Affirmative Action Employer. This literature is subject to all applicable copyright laws and is not for resale in any manner.

## PUBLICATION ORDERING INFORMATION

### LITERATURE FULFILLMENT:

Email Requests to: [orderlit@onsemi.com](mailto:orderlit@onsemi.com)

**onsemi Website:** [www.onsemi.com](http://www.onsemi.com)

### TECHNICAL SUPPORT

**North American Technical Support:**

Voice Mail: 1 800-282-9855 Toll Free USA/Canada

Phone: 011 421 33 790 2910

**Europe, Middle East and Africa Technical Support:**

Phone: 00421 33 790 2910

For additional information, please contact your local Sales Representative