

2N6487, 2N6488 (NPN), 2N6490, 2N6491 (PNP)



ON Semiconductor®

www.onsemi.com

Complementary Silicon Plastic Power Transistors

These devices are designed for use in general-purpose amplifier and switching applications.

Features

- High DC Current Gain
- High Current Gain – Bandwidth Product
- TO–220 Compact Package
- These Devices are Pb–Free and are RoHS Compliant*

MAXIMUM RATINGS (Note 1)

Rating	Symbol	Value	Unit
Collector–Emitter Voltage 2N6487, 2N6490 2N6488, 2N6491	V_{CEO}	60 80	Vdc
Collector–Base Voltage 2N6487, 2N6490 2N6488, 2N6491	V_{CB}	70 90	Vdc
Emitter–Base Voltage	V_{EB}	5.0	Vdc
Collector Current – Continuous	I_C	15	Adc
Base Current	I_B	5.0	Adc
Total Power Dissipation @ $T_C = 25^\circ\text{C}$ Derate above 25°C	P_D	75 0.6	W W/ $^\circ\text{C}$
Total Power Dissipation @ $T_A = 25^\circ\text{C}$ Derate above 25°C	P_D	1.8 0.014	W W/ $^\circ\text{C}$
Operating and Storage Junction Temperature Range	T_J, T_{stg}	–65 to +150	$^\circ\text{C}$

Stresses exceeding those listed in the Maximum Ratings table may damage the device. If any of these limits are exceeded, device functionality should not be assumed, damage may occur and reliability may be affected.

1. Indicates JEDEC Registered Data.

THERMAL CHARACTERISTICS

Characteristics	Symbol	Max	Unit
Thermal Resistance, Junction–to–Case	$R_{\theta JC}$	1.67	$^\circ\text{C/W}$
Thermal Resistance, Junction–to–Ambient	$R_{\theta JA}$	70	$^\circ\text{C/W}$

15 AMPERE COMPLEMENTARY SILICON POWER TRANSISTORS 60–80 VOLTS, 75 WATTS

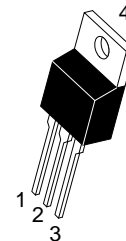
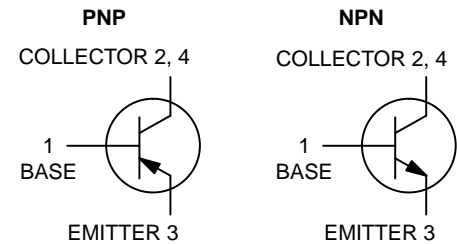

TO–220
CASE 221A
STYLE 1

MARKING DIAGRAM



2N64xx = Specific Device Code
xx = See Table on Page 5
G = Pb–Free Package
A = Assembly Location
Y = Year
WW = Work Week

ORDERING INFORMATION

See detailed ordering, marking, and shipping information in the package dimensions section on page 5 of this data sheet.

*For additional information on our Pb–Free strategy and soldering details, please download the ON Semiconductor Soldering and Mounting Techniques Reference Manual, SOLDERRM/D.

2N6487, 2N6488 (NPN), 2N6490, 2N6491 (PNP)

ELECTRICAL CHARACTERISTICS ($T_C = 25^\circ\text{C}$ unless otherwise noted) (Note 2)

Characteristic	Symbol	Min	Max	Unit
OFF CHARACTERISTICS				
Collector–Emitter Sustaining Voltage (Note 3) ($I_C = 200\text{ mAdc}$, $I_B = 0$) 2N6487, 2N6490 2N6488, 2N6491	$V_{CEO(sus)}$	60 80	– –	Vdc
Collector–Emitter Sustaining Voltage (Note 3) ($I_C = 200\text{ mAdc}$, $V_{BE} = 1.5\text{ Vdc}$) 2N6487, 2N6490 2N6488, 2N6491	V_{CEX}	70 90	– –	Vdc
Collector Cutoff Current ($V_{CE} = 30\text{ Vdc}$, $I_B = 0$) 2N6487, 2N6490 ($V_{CE} = 40\text{ Vdc}$, $I_B = 0$) 2N6488, 2N6491	I_{CEO}	– –	1.0 1.0	mAdc
Collector Cutoff Current ($V_{CE} = 65\text{ Vdc}$, $V_{EB(off)} = 1.5\text{ Vdc}$) 2N6487, 2N6490 ($V_{CE} = 85\text{ Vdc}$, $V_{EB(off)} = 1.5\text{ Vdc}$) 2N6488, 2N6491 ($V_{CE} = 60\text{ Vdc}$, $V_{EB(off)} = 1.5\text{ Vdc}$, $T_C = 150^\circ\text{C}$) 2N6487, 2N6490 ($V_{CE} = 80\text{ Vdc}$, $V_{EB(off)} = 1.5\text{ Vdc}$, $T_C = 150^\circ\text{C}$) 2N6488, 2N6491	I_{CEX}	– – – –	500 500 5.0 5.0	μAdc
Emitter Cutoff Current ($V_{BE} = 5.0\text{ Vdc}$, $I_C = 0$)	I_{EBO}	–	1.0	mAdc

ON CHARACTERISTICS

DC Current Gain ($I_C = 5.0\text{ Adc}$, $V_{CE} = 4.0\text{ Vdc}$) ($I_C = 15\text{ Adc}$, $V_{CE} = 4.0\text{ Vdc}$)	h_{FE}	20 5.0	150 –	–
Collector–Emitter Saturation Voltage ($I_C = 5.0\text{ Adc}$, $I_B = 0.5\text{ Adc}$) ($I_C = 15\text{ Adc}$, $I_B = 5.0\text{ Adc}$)	$V_{CE(sat)}$	– –	1.3 3.5	Vdc
Base–Emitter On Voltage ($I_C = 5.0\text{ Adc}$, $V_{CE} = 4.0\text{ Vdc}$) ($I_C = 15\text{ Adc}$, $V_{CE} = 4.0\text{ Vdc}$)	$V_{BE(on)}$	– –	1.3 3.5	Vdc

DYNAMIC CHARACTERISTICS

Current–Gain – Bandwidth Product (Note 4) ($I_C = 1.0\text{ Adc}$, $V_{CE} = 4.0\text{ Vdc}$, $f_{test} = 1.0\text{ MHz}$)	f_T	5.0	–	MHz
Small–Signal Current Gain ($I_C = 1.0\text{ Adc}$, $V_{CE} = 4.0\text{ Vdc}$, $f = 1.0\text{ kHz}$)	h_{fe}	25	–	–

Product parametric performance is indicated in the Electrical Characteristics for the listed test conditions, unless otherwise noted. Product performance may not be indicated by the Electrical Characteristics if operated under different conditions.

2. Indicates JEDEC Registered Data.

3. Pulse Test: Pulse Width $\leq 300\ \mu\text{s}$, Duty Cycle $\leq 2.0\%$.

4. $f_T = |h_{fe}| \cdot f_{test}$

2N6487, 2N6488 (NPN), 2N6490, 2N6491 (PNP)

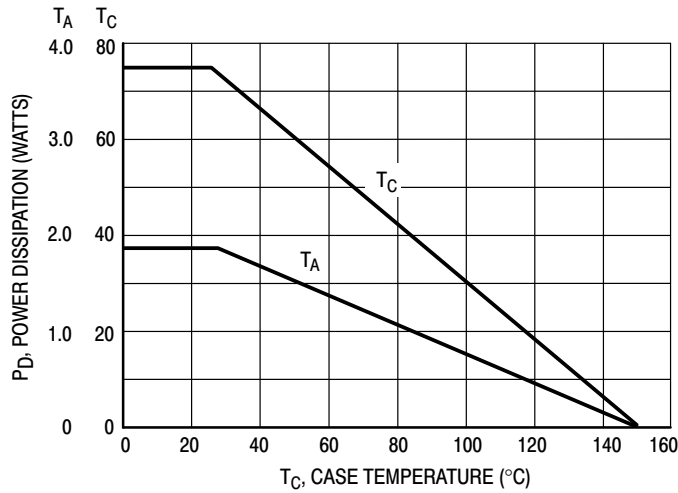
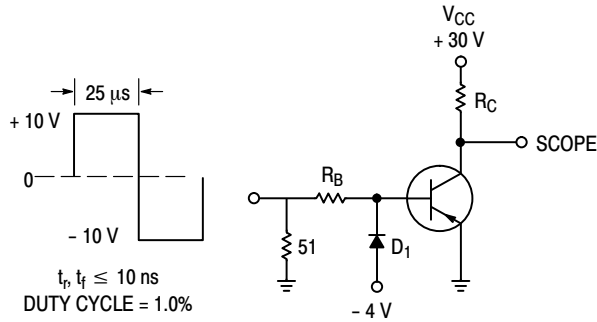

Figure 1. Power Derating



R_B AND R_C VARIED TO OBTAIN DESIRED CURRENT LEVELS. FOR PNP, REVERSE ALL POLARITIES.

D_1 MUST BE FAST RECOVERY TYPE, e.g.:
 1N5825 USED ABOVE $I_B \approx 100$ mA
 MSD6100 USED BELOW $I_B \approx 100$ mA

Figure 2. Switching Time Test Circuit

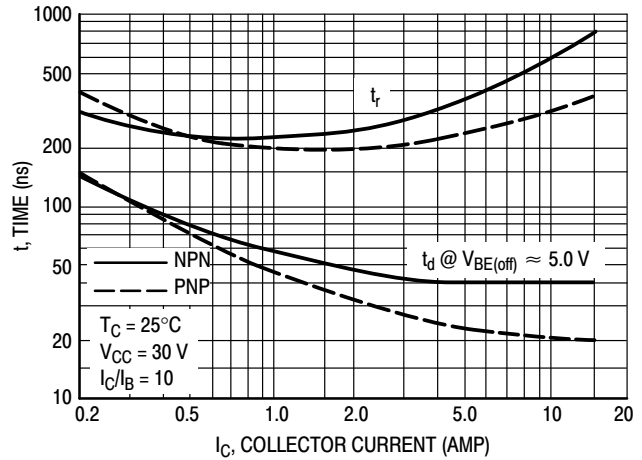

Figure 3. Turn-On Time

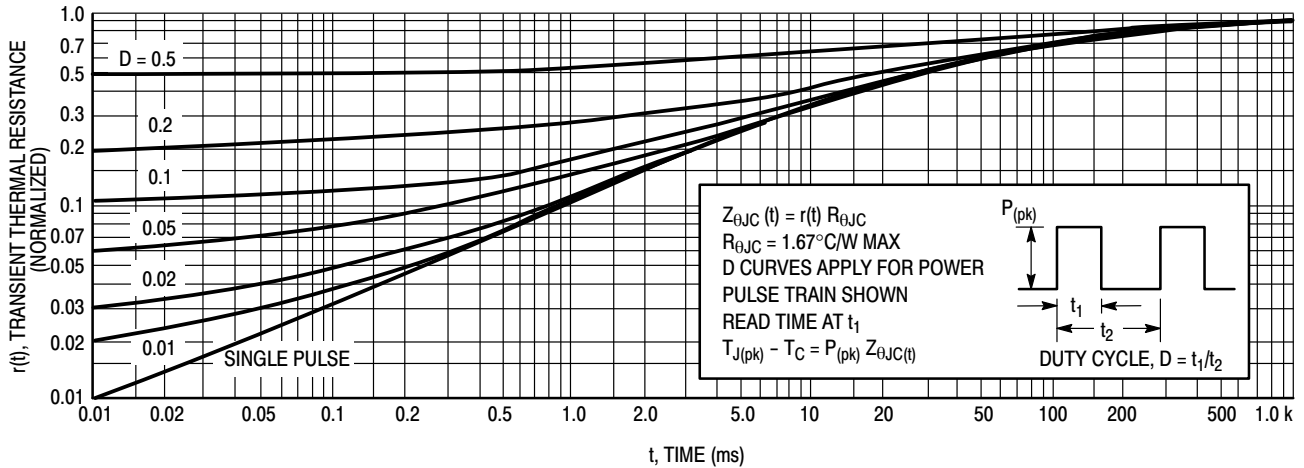

Figure 4. Thermal Response

2N6487, 2N6488 (NPN), 2N6490, 2N6491 (PNP)

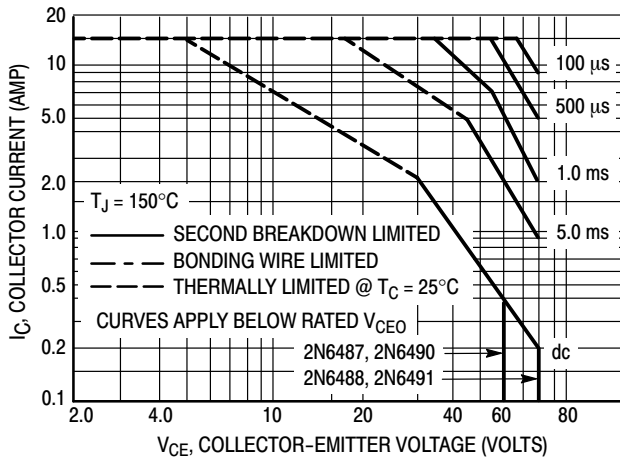

Figure 5. Active-Region Safe Operating Area

There are two limitations on the power handling ability of a transistor's average junction temperature and second breakdown. Safe operating area curves indicate $I_C - V_{CE}$ limits of the transistor that must be observed for reliable operation; i.e., the transistor must not be subjected to greater dissipation than the curves indicate.

The data of Figure 5 is based on $T_{J(pk)} = 150^\circ\text{C}$; T_C is variable depending on conditions. Second breakdown pulse limits are valid for duty cycles to 10% provided $T_{J(pk)} \leq 150^\circ\text{C}$. $T_{J(pk)}$ may be calculated from the data in Figure 4. At high case temperatures, thermal limitations will reduce the power that can be handled to values less than the limitations imposed by second breakdown.

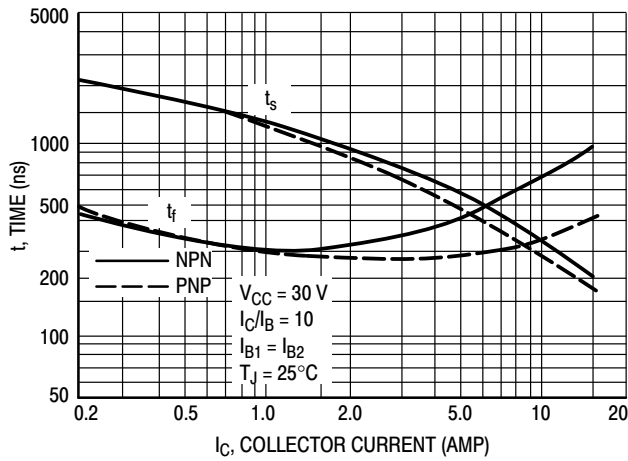

Figure 6. Turn-Off Time

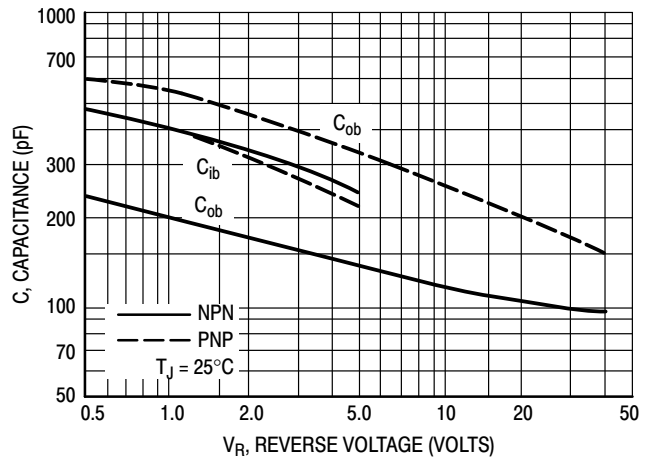
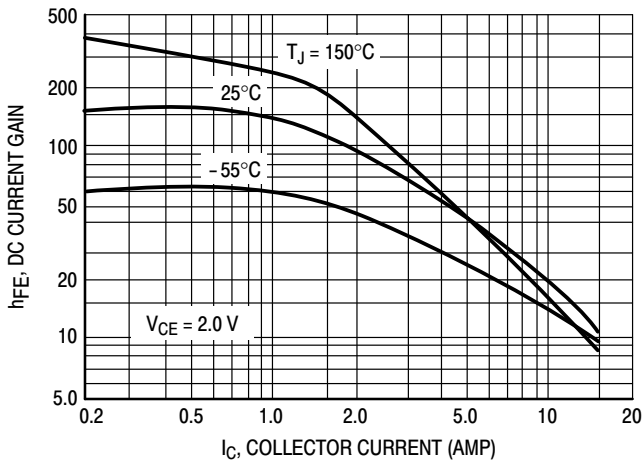

Figure 7. Capacitances

NPN 2N6487, 2N6488



PNP 2N6490, 2N6491

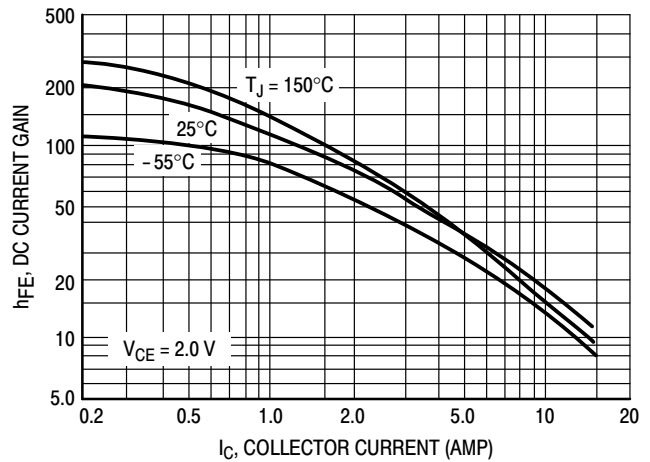

Figure 8. DC Current Gain

2N6487, 2N6488 (NPN), 2N6490, 2N6491 (PNP)

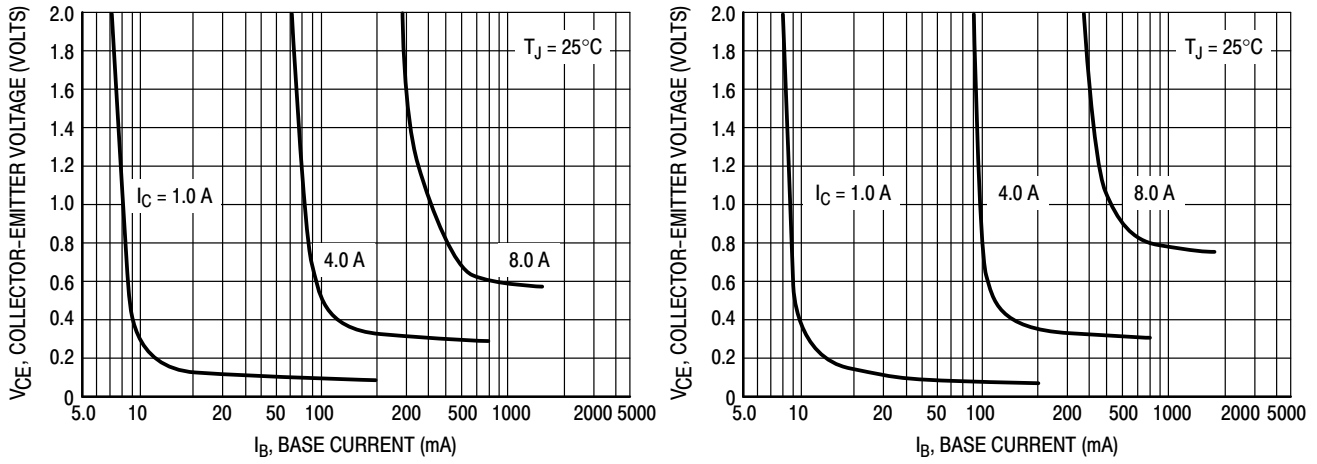

Figure 9. Collector Saturation Region

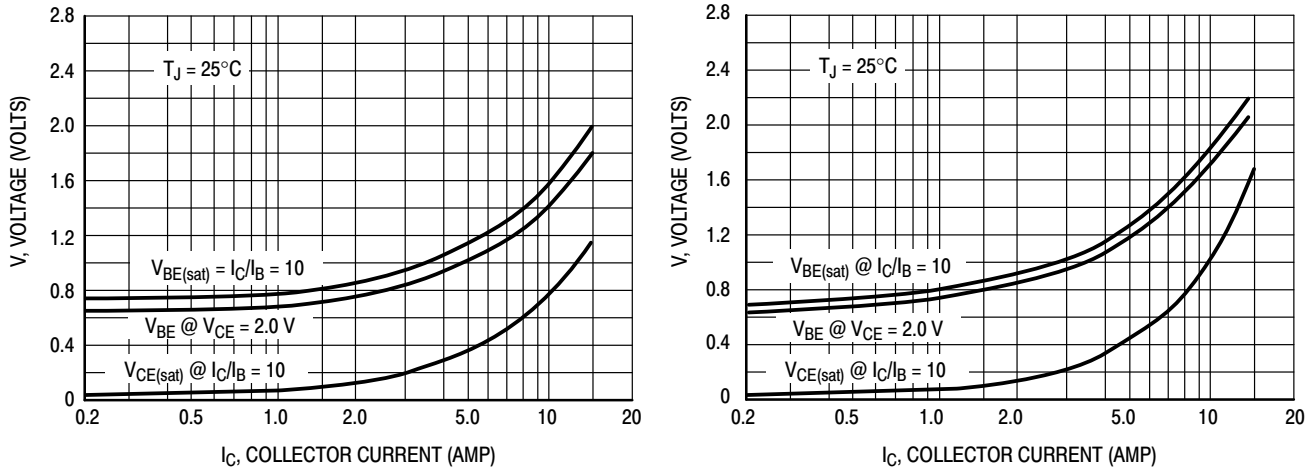

Figure 10. "On" Voltages

ORDERING INFORMATION

Device	Device Marking	Package	Shipping
2N6487G	2N6487	TO-220 (Pb-Free)	50 Units / Rail
2N6488G	2N6488	TO-220 (Pb-Free)	50 Units / Rail
2N6490G	2N6490	TO-220 (Pb-Free)	50 Units / Rail
2N6491G	2N6491	TO-220 (Pb-Free)	50 Units / Rail

MECHANICAL CASE OUTLINE PACKAGE DIMENSIONS



SCALE 1:1



TO-220 CASE 221A ISSUE AK

DATE 13 JAN 2022

NOTES:

1. DIMENSIONING AND TOLERANCING PER ANSI Y14.5M, 2009.
2. CONTROLLING DIMENSION: INCHES
3. DIMENSION Z DEFINES A ZONE WHERE ALL BODY AND LEAD IRREGULARITIES ARE ALLOWED.
4. MAX WIDTH FOR F102 DEVICE = 1.35MM

DIM	INCHES		MILLIMETERS	
	MIN.	MAX.	MIN.	MAX.
A	0.570	0.620	14.48	15.75
B	0.380	0.415	9.66	10.53
C	0.160	0.190	4.07	4.83
D	0.025	0.038	0.64	0.96
F	0.142	0.161	3.60	4.09
G	0.095	0.105	2.42	2.66
H	0.110	0.161	2.80	4.10
J	0.014	0.024	0.36	0.61
K	0.500	0.562	12.70	14.27
L	0.045	0.060	1.15	1.52
N	0.190	0.210	4.83	5.33
Q	0.100	0.120	2.54	3.04
R	0.080	0.110	2.04	2.79
S	0.045	0.055	1.15	1.41
T	0.235	0.255	5.97	6.47
U	0.000	0.050	0.00	1.27
V	0.045	---	1.15	---
Z	---	0.080	---	2.04

STYLE 1:
PIN 1. BASE
2. COLLECTOR
3. EMITTER
4. COLLECTOR

STYLE 2:
PIN 1. BASE
2. EMITTER
3. COLLECTOR
4. EMITTER

STYLE 3:
PIN 1. CATHODE
2. ANODE
3. GATE
4. ANODE

STYLE 4:
PIN 1. MAIN TERMINAL 1
2. MAIN TERMINAL 2
3. GATE
4. MAIN TERMINAL 2

STYLE 5:
PIN 1. GATE
2. DRAIN
3. SOURCE
4. DRAIN

STYLE 6:
PIN 1. ANODE
2. CATHODE
3. ANODE
4. CATHODE

STYLE 7:
PIN 1. CATHODE
2. ANODE
3. CATHODE
4. ANODE

STYLE 8:
PIN 1. CATHODE
2. ANODE
3. EXTERNAL TRIP/DELAY
4. ANODE

STYLE 9:
PIN 1. GATE
2. COLLECTOR
3. EMITTER
4. COLLECTOR

STYLE 10:
PIN 1. GATE
2. SOURCE
3. DRAIN
4. SOURCE

STYLE 11:
PIN 1. DRAIN
2. SOURCE
3. GATE
4. SOURCE

STYLE 12:
PIN 1. MAIN TERMINAL 1
2. MAIN TERMINAL 2
3. GATE
4. NOT CONNECTED

DOCUMENT NUMBER:	98ASB42148B	Electronic versions are uncontrolled except when accessed directly from the Document Repository. Printed versions are uncontrolled except when stamped "CONTROLLED COPY" in red.
DESCRIPTION:	TO-220	PAGE 1 OF 1

onsemi and onsemi are trademarks of Semiconductor Components Industries, LLC dba onsemi or its subsidiaries in the United States and/or other countries. onsemi reserves the right to make changes without further notice to any products herein. onsemi makes no warranty, representation or guarantee regarding the suitability of its products for any particular purpose, nor does onsemi assume any liability arising out of the application or use of any product or circuit, and specifically disclaims any and all liability, including without limitation special, consequential or incidental damages. onsemi does not convey any license under its patent rights nor the rights of others.

onsemi, **Onsemi**, and other names, marks, and brands are registered and/or common law trademarks of Semiconductor Components Industries, LLC dba "**onsemi**" or its affiliates and/or subsidiaries in the United States and/or other countries. **onsemi** owns the rights to a number of patents, trademarks, copyrights, trade secrets, and other intellectual property. A listing of **onsemi**'s product/patent coverage may be accessed at www.onsemi.com/site/pdf/Patent-Marking.pdf. **onsemi** reserves the right to make changes at any time to any products or information herein, without notice. The information herein is provided "as-is" and **onsemi** makes no warranty, representation or guarantee regarding the accuracy of the information, product features, availability, functionality, or suitability of its products for any particular purpose, nor does **onsemi** assume any liability arising out of the application or use of any product or circuit, and specifically disclaims any and all liability, including without limitation special, consequential or incidental damages. Buyer is responsible for its products and applications using **onsemi** products, including compliance with all laws, regulations and safety requirements or standards, regardless of any support or applications information provided by **onsemi**. "Typical" parameters which may be provided in **onsemi** data sheets and/or specifications can and do vary in different applications and actual performance may vary over time. All operating parameters, including "Typicals" must be validated for each customer application by customer's technical experts. **onsemi** does not convey any license under any of its intellectual property rights nor the rights of others. **onsemi** products are not designed, intended, or authorized for use as a critical component in life support systems or any FDA Class 3 medical devices or medical devices with a same or similar classification in a foreign jurisdiction or any devices intended for implantation in the human body. Should Buyer purchase or use **onsemi** products for any such unintended or unauthorized application, Buyer shall indemnify and hold **onsemi** and its officers, employees, subsidiaries, affiliates, and distributors harmless against all claims, costs, damages, and expenses, and reasonable attorney fees arising out of, directly or indirectly, any claim of personal injury or death associated with such unintended or unauthorized use, even if such claim alleges that **onsemi** was negligent regarding the design or manufacture of the part. **onsemi** is an Equal Opportunity/Affirmative Action Employer. This literature is subject to all applicable copyright laws and is not for resale in any manner.

PUBLICATION ORDERING INFORMATION

LITERATURE FULFILLMENT:

Email Requests to: orderlit@onsemi.com

onsemi Website: www.onsemi.com

TECHNICAL SUPPORT

North American Technical Support:

Voice Mail: 1 800-282-9855 Toll Free USA/Canada

Phone: 011 421 33 790 2910

Europe, Middle East and Africa Technical Support:

Phone: 00421 33 790 2910

For additional information, please contact your local Sales Representative