

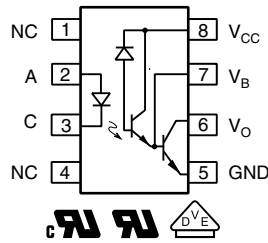

# High Speed Optocoupler, 100 k Bd, Low Input Current, High Gain

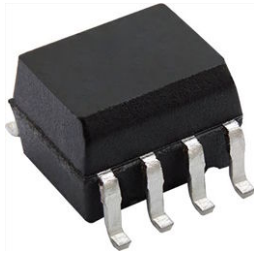

### FEATURES

- High current transfer ratio, 300 %
- Low input current, 0.5 mA
- High output current, 60 mA
- TTL compatible output,  $V_{OL} = 0.1 V$
- Adjustable bandwidth access to base
- Material categorization: for definitions of compliance please see [www.vishay.com/doc?99912](http://www.vishay.com/doc?99912)



RoHS COMPLIANT

### LINKS TO ADDITIONAL RESOURCES



### DESCRIPTION

The SFH6318 is ideal for TTL applications since the 300 % minimum current transfer ratio with an LED current of 1.6 mA enables operation with one unit load-in and one unit load-out with a 2.2 kΩ pull-up resistor.

The SFH6319 is best suited for low power logic applications involving CMOS and low power TTL. A 400 % current transfer ratio with only 0.5 mA of LED current is guaranteed from 0 °C to 70 °C.

Very high current ratio together with 4000  $V_{RMS}$  isolation are achieved by coupling an LED with an integrated high gain photo detector in a SOIC-8 package. Separate pins for the photo diode and output stage enable TTL compatible saturation voltages with high speed operation. Photodarlington operation is achieved by tying the  $V_{CC}$  and  $V_O$  terminals together. Access to the base terminal allows adjustment to the gain bandwidth.

### APPLICATIONS

- Logic ground isolation - TTL / TTL, TTL / CMOS, CMOS / CMOS, CMOS / TTL
- EIA RS 232C line receiver
- Low input current line receiver long lines, party lines
- Telephone ring detector
- Line voltage status indication - low input power dissipation
- Low power systems - ground isolation

### AGENCY APPROVALS

- [UL1577](#)
- [cUL](#)
- [DIN EN 60747-5-5 \(VDE 0884-5\) available with option 1](#)
- [CSA](#)

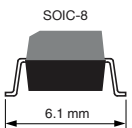
ORDERING INFORMATION		
<div style="display: flex; justify-content: space-around; align-items: center;"> <div style="border: 1px solid black; padding: 2px 5px;">S</div> <div style="border: 1px solid black; padding: 2px 5px;">F</div> <div style="border: 1px solid black; padding: 2px 5px;">H</div> <div style="border: 1px solid black; padding: 2px 5px;">6</div> <div style="border: 1px solid black; padding: 2px 5px;">3</div> <div style="border: 1px solid black; padding: 2px 5px;">1</div> <div style="border: 1px solid black; padding: 2px 5px;">#</div> <div style="border: 1px solid black; padding: 2px 5px;">-</div> <div style="border: 1px solid black; padding: 2px 5px;">X</div> <div style="border: 1px solid black; padding: 2px 5px;">0</div> <div style="border: 1px solid black; padding: 2px 5px;">#</div> <div style="border: 1px solid black; padding: 2px 5px;">#</div> <div style="border: 1px solid black; padding: 2px 5px;">T</div> </div> <div style="display: flex; justify-content: space-around; margin-top: 5px;"> <span>PART NUMBER</span> <span>PACKAGE OPTION</span> <span>TAPE AND REEL</span> </div>		
AGENCY CERTIFIED / PACKAGE	CTR (%)	
UL, cUL, CSA	≥ 300	≥ 500
SOIC-8	SFH6318T	SFH6319T

### Note

- Additional options may be possible, please contact sales office



ABSOLUTE MAXIMUM RATINGS ( $T_{amb} = 25\text{ }^{\circ}\text{C}$ , unless otherwise specified)					
PARAMETER	TEST CONDITION	PART	SYMBOL	VALUE	UNIT
<b>INPUT</b>					
Reverse voltage			$V_R$	3	V
Supply and output voltage	$V_{CC}$ (pin 8 to 5), $V_O$ (pin 6 to 5)	SFH6318	$V_{CC}, V_O$	-0.5 to 7	V
		SFH6319	$V_{CC}, V_O$	-0.5 to 18	V
Input power dissipation			$P_{diss}$	35	mW
Average input current			$I_{F(AVG)}$	20	mA
Peak input current	50 % duty cycle; 1 ms pulse width		$I_{FRM}$	40	mA
Peak transient input current	$t_p \leq 1\text{ }\mu\text{s}$ , 300 pps		$I_{FSM}$	1	A
<b>OUTPUT</b>					
Output current (pin 6)			$I_O$	60	mA
Emitter-base reverse current (pin 5 to 7)			$V_{EB0}$	0.5	V
Output power dissipation			$P_{diss}$	150	mW
Derate linearly from 25 $^{\circ}\text{C}$				2	mW/ $^{\circ}\text{C}$
<b>COUPLER</b>					
Storage temperature			$T_{stg}$	-55 to +125	$^{\circ}\text{C}$
Lead soldering temperature	$t = 10\text{ s}$		$T_{slid}$	260	$^{\circ}\text{C}$
Junction temperature			$T_j$	125	$^{\circ}\text{C}$
Ambient temperature range			$T_{amb}$	-55 to +100	$^{\circ}\text{C}$
Total power dissipation			$P_{diss}$	185	mW

**Note**

- Stresses in excess of the absolute maximum ratings can cause permanent damage to the device. Functional operation of the device is not implied at these or any other conditions in excess of those given in the operational sections of this document. Exposure to absolute maximum ratings for extended periods of the time can adversely affect reliability

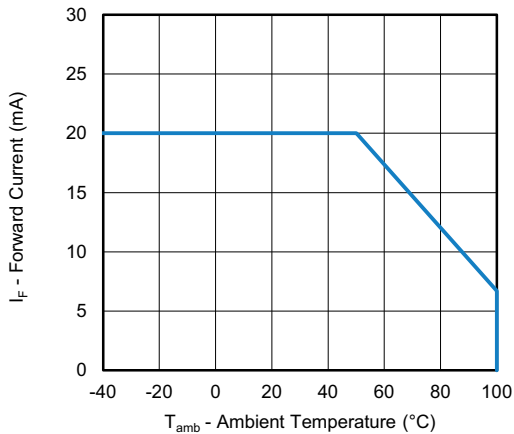

Fig. 1 - Forward Current vs. Ambient Temperature

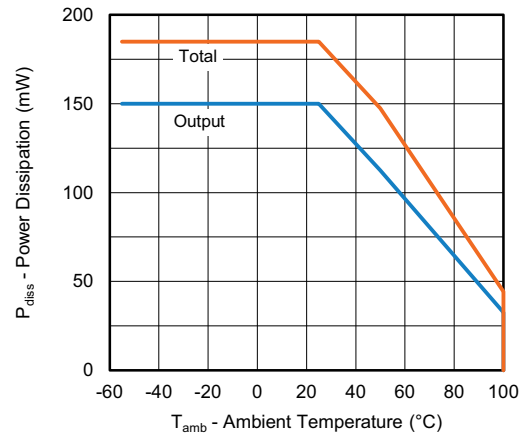

Fig. 2 - Power Dissipation vs. Ambient Temperature



<b>ELECTRICAL CHARACTERISTICS</b> ( $T_{amb} = 0\text{ }^{\circ}\text{C}$ to $70\text{ }^{\circ}\text{C}$ ; typical values are at $T_{amb} = 25\text{ }^{\circ}\text{C}$ )						
PARAMETER	TEST CONDITION	SYMBOL	MIN.	TYP.	MAX.	UNIT
<b>INPUT</b>						
Forward voltage	$I_F = 1.6\text{ mA}$	$V_F$	-	1.28	1.7	V
Temperature coefficient of forward voltage	$I_F = 1.6\text{ mA}$	$\Delta V_F / \Delta T_{amb}$	-	-2.3	-	mV/ $^{\circ}\text{C}$
Input capacitance	$f = 1\text{ MHz}, V_F = 0$	$C_{IN}$	-	55	-	pF
<b>OUTPUT</b>						
Logic low output voltage <sup>(1)</sup>	$I_F = 1.6\text{ mA}, I_O = 4.8\text{ mA}, V_{CC} = 4.5\text{ V}$	$V_{OL}$	-	0.1	0.4	V
	$I_F = 1.6\text{ mA}, I_O = 8\text{ mA}, V_{CC} = 4.5\text{ V}$	$V_{OL}$	-	0.1	0.4	V
	$I_F = 5\text{ mA}, I_O = 15\text{ mA}, V_{CC} = 4.5\text{ V}$	$V_{OL}$	-	0.15	0.4	V
	$I_F = 12\text{ mA}, I_O = 24\text{ mA}, V_{CC} = 4.5\text{ V}$	$V_{OL}$	-	0.25	0.4	V
Logic high output current <sup>(1)</sup>	$I_F = 0\text{ mA}, V_O = V_{CC} = 7\text{ V}$	$I_{IO}$	-	0.1	250	$\mu\text{A}$
	$I_F = 0\text{ mA}, V_O = V_{CC} = 18\text{ V}$	$I_{IO}$	-	0.05	100	$\mu\text{A}$
Logic low supply current <sup>(1)</sup>	$I_F = 1.6\text{ mA}, V_O = \text{OPEN}, V_{CC} = 18\text{ V}$	$I_{CCL}$	-	0.3	1.5	mA
Logic high supply current <sup>(1)</sup>	$I_F = 0\text{ mA}, V_O = \text{OPEN}, V_{CC} = 18\text{ V}$	$I_{CCH}$	-	0.0003	10	$\mu\text{A}$
<b>COUPLER</b>						
Capacitance (input to output) <sup>(2)</sup>	$f = 1\text{ MHz}$	$C_{IO}$	-	0.6	-	pF

**Notes**

- Minimum and maximum values are testing requirements. Typical values are characteristics of the device and are the result of engineering evaluation. Typical values are for information only and are not part of the testing requirements

(1) Pin 7 open

(2) Device considered a two-terminal device: pins 1, 2, 3, and 4 shorted together and pins 5, 6, 7, and 8 shorted together

<b>CURRENT TRANSFER RATIO</b> ( $T_{amb} = 0\text{ }^{\circ}\text{C}$ to $70\text{ }^{\circ}\text{C}$ ; typical values are at $T_{amb} = 25\text{ }^{\circ}\text{C}$ )							
PARAMETER	TEST CONDITION	PART	SYMBOL	MIN.	TYP.	MAX.	UNIT
Current transfer ratio <sup>(1)</sup>	$I_F = 1.6\text{ mA}, V_O = 0.4\text{ V}, V_{CC} = 4.5\text{ V}$	SFH6318	CTR	300	2000	2600	%
	$I_F = 0.5\text{ mA}, V_O = 0.4\text{ V}, V_{CC} = 4.5\text{ V}$	SFH6319	CTR	400	2200	3500	%
	$I_F = 1.6\text{ mA}, V_O = 0.4\text{ V}, V_{CC} = 4.5\text{ V}$	SFH6319	CTR	500	2000	2600	%

**Notes**

- DC current transfer ratio is defined as the ratio of output collector current,  $I_O$ , to the forward LED input current,  $I_F$  times 100 %

(1) Pin 7 open

<b>SWITCHING CHARACTERISTICS</b> ( $T_{amb} = 25\text{ }^{\circ}\text{C}$ )							
PARAMETER	TEST CONDITION	PART	SYMBOL	MIN.	TYP.	MAX.	UNIT
Propagation delay time to low output level	$I_F = 1.6\text{ mA}, R_L = 2.2\text{ k}\Omega$	SFH6318	$t_{PHL}$	-	2	10	$\mu\text{s}$
Propagation delay time to low output level <sup>(1)(2)</sup>	$I_F = 0.5\text{ mA}, R_L = 4.7\text{ k}\Omega$	SFH6319	$t_{PHL}$	-	4	25	$\mu\text{s}$
Propagation delay time to high output level <sup>(1)(2)</sup>	$I_F = 12\text{ mA}, R_L = 270\ \Omega$	SFH6319	$t_{PHL}$	-	0.5	1	$\mu\text{s}$
Propagation delay time to high output level	$I_F = 1.6\text{ mA}, R_L = 2.2\text{ k}\Omega$	SFH6318	$t_{PLH}$	-	15	35	$\mu\text{s}$
Propagation delay time to high output level <sup>(1)(2)</sup>	$I_F = 0.5\text{ mA}, R_L = 4.7\text{ k}\Omega$	SFH6319	$t_{PLH}$	-	30	60	$\mu\text{s}$
Propagation delay time to high output level <sup>(1)(2)</sup>	$I_F = 12\text{ mA}, R_L = 270\ \Omega$	SFH6319	$t_{PLH}$	-	3	7	$\mu\text{s}$

**Notes**

(1) Pin 7 open

(2) Using a resistor between pin 5 and 7 will decrease gain and delay time





<b>SAFETY AND INSULATION RATINGS</b> ( $T_{amb} = 25\text{ }^{\circ}\text{C}$ , unless otherwise specified)				
PARAMETER	TEST CONDITION	SYMBOL	VALUE	UNIT
Climatic classification	According to IEC 68 part 1		55 / 100 / 21	
Pollution degree	According to DIN VDE 0109		2	
Comparative tracking index	Insulation group IIIa	CTI	175	
Maximum rated withstanding isolation voltage	According to UL1577, $t = 1\text{ min}$	$V_{ISO}$	3333	$V_{RMS}$
Tested withstanding isolation voltage	According to UL1577, $t = 1\text{ s}$	$V_{ISO}$	4000	$V_{RMS}$
Maximum transient isolation voltage	According to DIN EN 60747-5-5	$V_{IOTM}$	6000	$V_{peak}$
Maximum repetitive peak isolation voltage	According to DIN EN 60747-5-5	$V_{IORM}$	560	$V_{peak}$
Isolation resistance	$V_{IO} = 500\text{ V}$ , $T_{amb} = 25\text{ }^{\circ}\text{C}$	$R_{IO}$	$\geq 10^{12}$	$\Omega$
	$V_{IO} = 500\text{ V}$ , $T_{amb} = 100\text{ }^{\circ}\text{C}$	$R_{IO}$	$\geq 10^{11}$	$\Omega$
	$V_{IO} = 500\text{ V}$ , $T_{amb} = T_s$	$R_{IO}$	$\geq 10^9$	$\Omega$
Output safety power		$P_{SO}$	350	mW
Input safety current		$I_{SI}$	150	mA
Safety temperature		$T_s$	165	$^{\circ}\text{C}$
Creepage distance			$\geq 4$	mm
Clearance distance			$\geq 4$	mm
Insulation thickness		DTI	$\geq 0.3$	mm
Input to output test voltage, method B	$V_{IORM} \times 1.875 = V_{PR}$ , 100 % production test with $t_M = 1\text{ s}$ , partial discharge $< 5\text{ pC}$	$V_{PR}$	1050	$V_{peak}$
Input to output test voltage, method A	$V_{IORM} \times 1.6 = V_{PR}$ , 100 % sample test with $t_M = 10\text{ s}$ , partial discharge $< 5\text{ pC}$	$V_{PR}$	896	$V_{peak}$

**Note**

- As per IEC 60747-5-5, § 7.4.3.8.2, this optocoupler is suitable for “safe electrical insulation” only within the safety ratings. Compliance with the safety ratings shall be ensured by means of protective circuits

**TYPICAL CHARACTERISTICS** ( $T_{amb} = 25\text{ }^{\circ}\text{C}$ , unless otherwise specified)

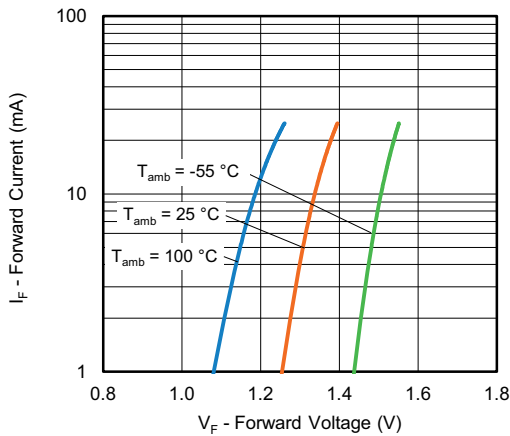

Fig. 5 - Forward Current vs. Forward Voltage

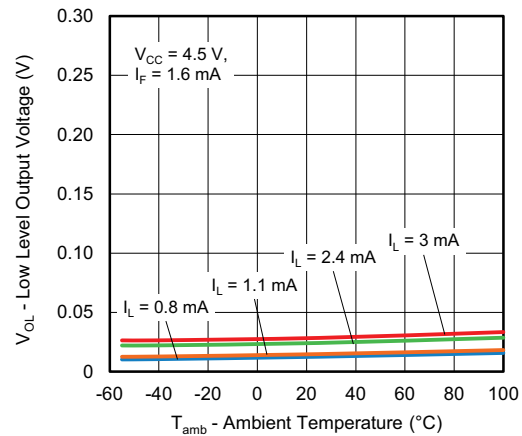

Fig. 8 - Low Level Output Voltage vs. Ambient Temperature

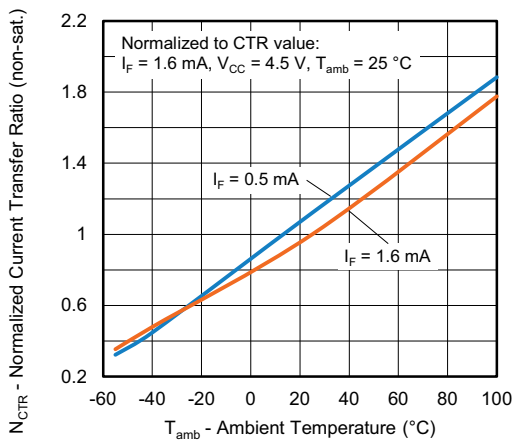

Fig. 6 - Normalized Current Transfer Ratio (non-saturated) vs. Ambient Temperature

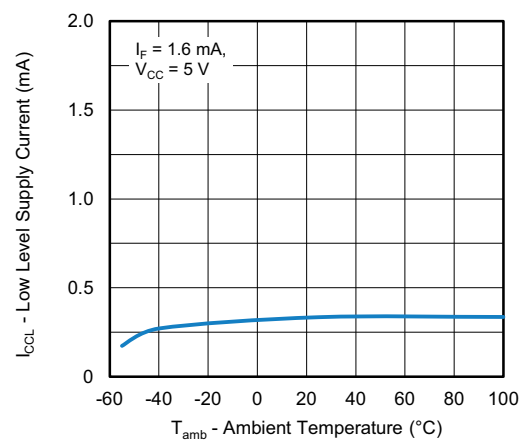

Fig. 9 - Low Level Supply Current vs. Ambient Temperature

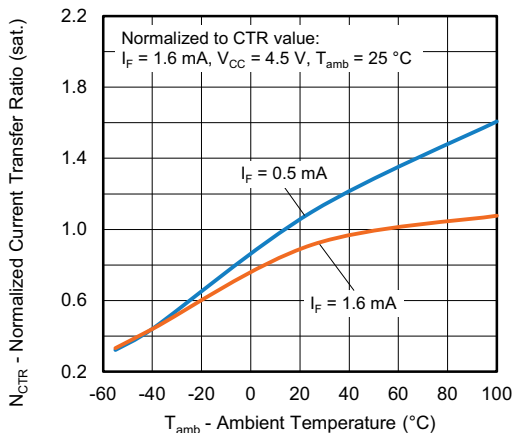

Fig. 7 - Normalized Current Transfer Ratio (saturated) vs. Ambient Temperature

## PACKAGE DIMENSIONS (in millimeters)

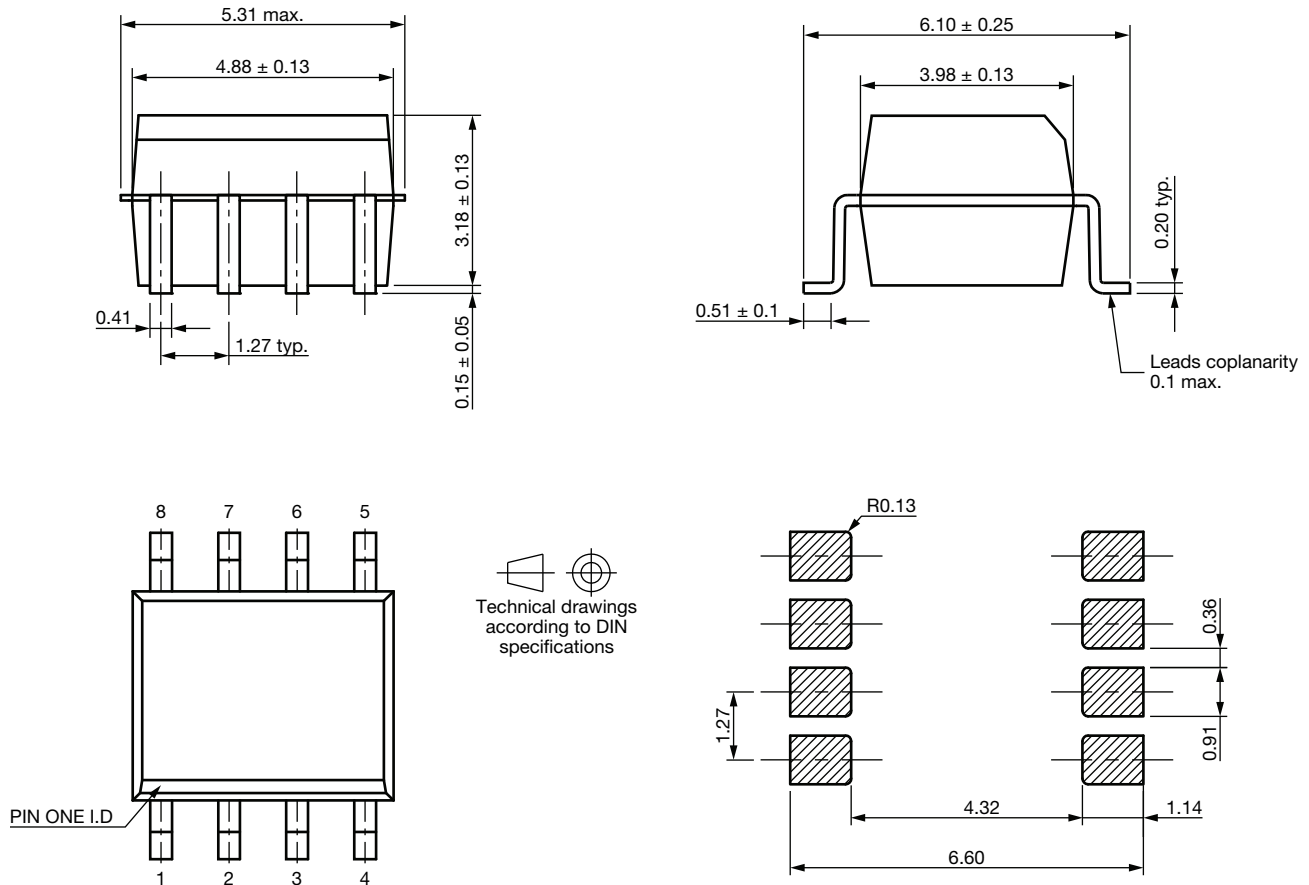

Fig. 10 - Package Drawing

## PACKAGE MARKING

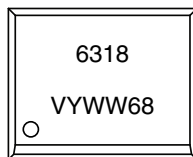

Fig. 11 - Example of SFH6318

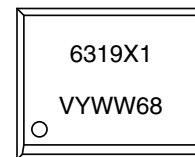

Fig. 12 - Example of SFH6319-X001T

### Notes

- “YWW” is the date code marking (Y = year code, WW = week code)
- “X1” is only marked on option 1 parts
- Tape and reel suffix (T) is not part of the package marking

**PACKING INFORMATION** (in millimeters)

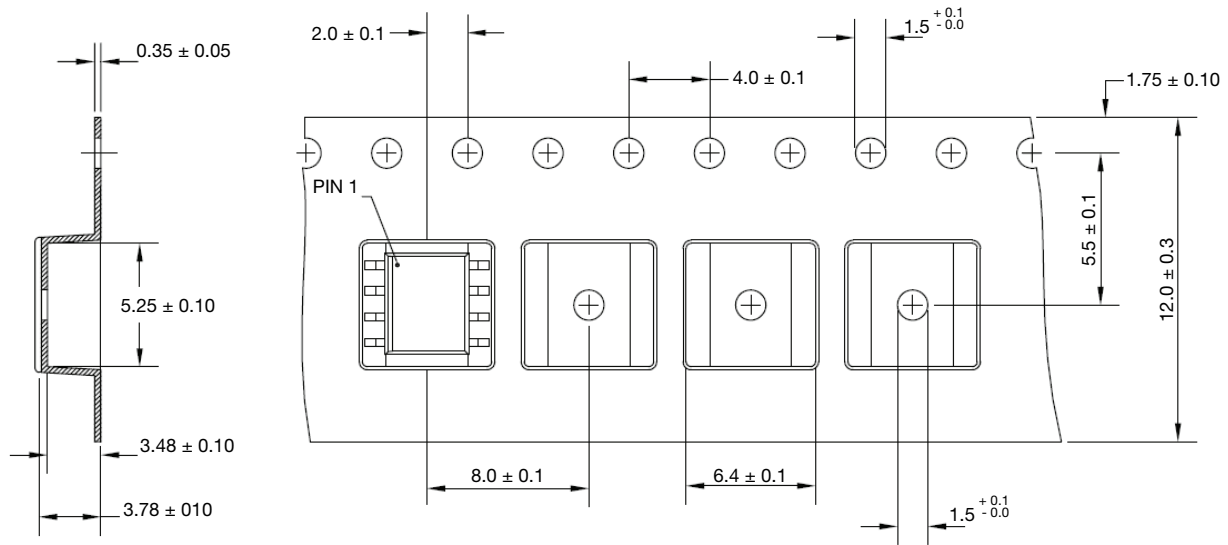

Fig. 13 - Tape and Reel Packing (2000 pieces on reel)

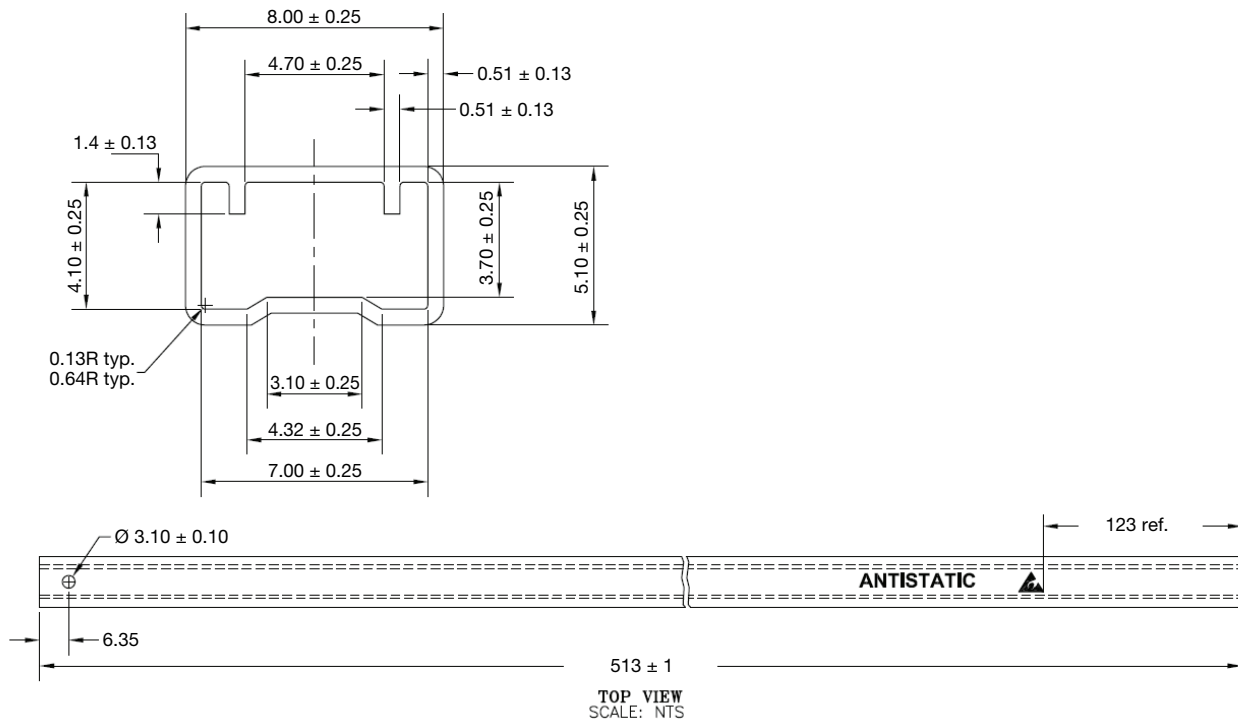

Fig. 14 - Tube Packing

DEVICE PER TUBE			
TYPE	UNITS/TUBE	TUBES/BOX	UNITS/BOX
SOIC-8	100	30	3000





**SOLDER PROFILE**

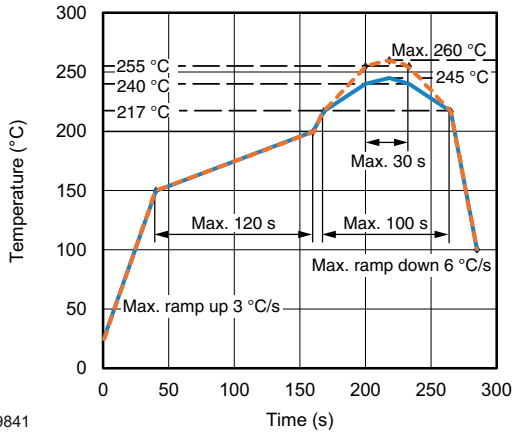

19841

Fig. 15 - Lead (Pb)-free Reflow Solder Profile according to J-STD-020

**HANDLING AND STORAGE CONDITIONS**

ESD level: HBM class 2

Floor life: unlimited

Conditions:  $T_{amb} < 30\text{ °C}$ , RH < 85 %

Moisture sensitivity level 1, according to J-STD-020



## **Disclaimer**

ALL PRODUCT, PRODUCT SPECIFICATIONS AND DATA ARE SUBJECT TO CHANGE WITHOUT NOTICE TO IMPROVE RELIABILITY, FUNCTION OR DESIGN OR OTHERWISE.

Vishay Intertechnology, Inc., its affiliates, agents, and employees, and all persons acting on its or their behalf (collectively, "Vishay"), disclaim any and all liability for any errors, inaccuracies or incompleteness contained in any datasheet or in any other disclosure relating to any product.

Vishay makes no warranty, representation or guarantee regarding the suitability of the products for any particular purpose or the continuing production of any product. To the maximum extent permitted by applicable law, Vishay disclaims (i) any and all liability arising out of the application or use of any product, (ii) any and all liability, including without limitation special, consequential or incidental damages, and (iii) any and all implied warranties, including warranties of fitness for particular purpose, non-infringement and merchantability.

Statements regarding the suitability of products for certain types of applications are based on Vishay's knowledge of typical requirements that are often placed on Vishay products in generic applications. Such statements are not binding statements about the suitability of products for a particular application. It is the customer's responsibility to validate that a particular product with the properties described in the product specification is suitable for use in a particular application. Parameters provided in datasheets and / or specifications may vary in different applications and performance may vary over time. All operating parameters, including typical parameters, must be validated for each customer application by the customer's technical experts. Product specifications do not expand or otherwise modify Vishay's terms and conditions of purchase, including but not limited to the warranty expressed therein.

Hyperlinks included in this datasheet may direct users to third-party websites. These links are provided as a convenience and for informational purposes only. Inclusion of these hyperlinks does not constitute an endorsement or an approval by Vishay of any of the products, services or opinions of the corporation, organization or individual associated with the third-party website. Vishay disclaims any and all liability and bears no responsibility for the accuracy, legality or content of the third-party website or for that of subsequent links.

Except as expressly indicated in writing, Vishay products are not designed for use in medical, life-saving, or life-sustaining applications or for any other application in which the failure of the Vishay product could result in personal injury or death. Customers using or selling Vishay products not expressly indicated for use in such applications do so at their own risk. Please contact authorized Vishay personnel to obtain written terms and conditions regarding products designed for such applications.

No license, express or implied, by estoppel or otherwise, to any intellectual property rights is granted by this document or by any conduct of Vishay. Product names and markings noted herein may be trademarks of their respective owners.