

## Insulated Gen 2 Schottky Rectifier Module, 250 A



SOT-227

**RoHS**  
COMPLIANT

### FEATURES

- Max.  $T_J = 175\text{ }^\circ\text{C}$
- Two fully independent diodes
- Fully insulated package
- Trench MOS Barrier Schottky technology
- Ultra low forward voltage drop
- Optimized for power conversion: welding and industrial SMPS applications
- Easy to use and parallel
- Industry standard outline
- UL approved file E78996 
- Designed and qualified for industrial level
- Material categorization: for definitions of compliance please see [www.vishay.com/doc?99912](http://www.vishay.com/doc?99912)

### DESCRIPTION

The VS-QA250FA20 insulated modules integrate two state of the art Trench MOS Schottky technology rectifiers in the compact, industry standard SOT-227 package.

These devices are thus intended for high frequency converters and switching power supplies.

PRIMARY CHARACTERISTICS	
$I_{F(AV)}$ per module at $T_C = 106\text{ }^\circ\text{C}$	250 A
$V_R$	200 V
$V_{FM}$ at 200 A, $T_C = 25\text{ }^\circ\text{C}$	1.0 V
Package	SOT-227
Circuit configuration	Two separate diodes, parallel pin-out

MAJOR RATINGS AND CHARACTERISTICS			
SYMBOL	CHARACTERISTICS	VALUES	UNITS
$V_F$	$T_J = 125\text{ }^\circ\text{C}$	1.09	V
$T_J$	Range	-55 to +175	$^\circ\text{C}$

ABSOLUTE MAXIMUM RATINGS ( $T_C = 25\text{ }^\circ\text{C}$ unless otherwise specified)				
PARAMETER	SYMBOL	TEST CONDITIONS	VALUES	UNITS
Maximum average forward current per module	$I_{F(AV)}$	$T_C = 106\text{ }^\circ\text{C}$	250	A
Maximum cathode to anode voltage	$V_R$		200	V
Maximum continuous forward current per diode	$I_F$	$T_C = 95\text{ }^\circ\text{C}$	183	A
Maximum single pulse forward current per diode	$I_{FSM}$	$T_C = 175\text{ }^\circ\text{C}$ , $t = 6\text{ ms}$ , square	900	
Maximum power dissipation per diode	$P_D$	$T_C = 95\text{ }^\circ\text{C}$	182	W
Non-repetitive avalanche energy per diode	$E_{AS}$	$T_J = 25\text{ }^\circ\text{C}$ , $I_{AS} = 19\text{ A}$ , $L = 10\text{ mH}$	1800	mJ
RMS isolation voltage	$V_{ISOL}$	Any terminal to case, $t = 1\text{ minute}$	2500	V
Operating junction and storage temperatures	$T_J, T_{Stg}$		-55 to +175	$^\circ\text{C}$



ELECTRICAL SPECIFICATIONS PER DIODE ( $T_J = 25\text{ }^\circ\text{C}$ unless otherwise specified)						
PARAMETER	SYMBOL	TEST CONDITIONS	MIN.	TYP.	MAX.	UNITS
Cathode to anode breakdown voltage	$V_{BR}$	$I_R = 2\text{ mA}$	200	-	-	V
Forward voltage	$V_{FM}$	$I_F = 200\text{ A}$	-	1.0	1.2	
		$I_F = 200\text{ A}, T_J = 125\text{ }^\circ\text{C}$	-	0.89	1.09	
Reverse leakage current	$I_{RM}$	$V_R = 200\text{ V}$	-	13	90	$\mu\text{A}$
		$T_J = 125\text{ }^\circ\text{C}, V_R = V_R\text{ rated}$	-	14	-	mA
Junction capacitance	$C_T$	$V_R = 200\text{ V}$	-	380	-	pF

DYNAMIC RECOVERY CHARACTERISTICS ( $T_J = 25\text{ }^\circ\text{C}$ unless otherwise specified)							
PARAMETER	SYMBOL	TEST CONDITIONS	MIN.	TYP.	MAX.	UNITS	
Reverse recovery time	$t_{rr}$	$T_J = 25\text{ }^\circ\text{C}$	-	54	-	ns	
		$T_J = 125\text{ }^\circ\text{C}$	-	67	-		
Peak recovery current	$I_{RRM}$	$T_J = 25\text{ }^\circ\text{C}$	$I_F = 50\text{ A}$ $di_F/dt = 200\text{ A}/\mu\text{s}$ $V_R = 100\text{ V}$	-	6	A	
		$T_J = 125\text{ }^\circ\text{C}$		-	8.4		-
Reverse recovery charge	$Q_{rr}$	$T_J = 25\text{ }^\circ\text{C}$		-	165	-	nC
		$T_J = 125\text{ }^\circ\text{C}$		-	296	-	

THERMAL - MECHANICAL SPECIFICATIONS						
PARAMETER	SYMBOL	TEST CONDITIONS	MIN.	TYP.	MAX.	UNITS
Junction to case, single leg conducting	$R_{thJC}$		-	-	0.44	$^\circ\text{C}/\text{W}$
Junction to case, both leg conducting			-	-	0.22	
Case to heatsink	$R_{thCS}$	Flat, greased surface	-	0.1	-	
Weight			-	30	-	g
Mounting torque		Torque to terminal	-	-	1.1 (9.7)	Nm (lbf.in)
		Torque to heatsink	-	-	1.8 (15.9)	Nm (lbf.in)
Case style			SOT-227			

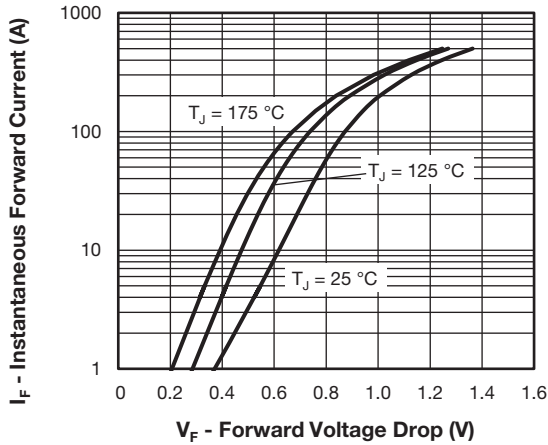

Fig. 1 - Typical Forward Voltage Drop vs. Instantaneous Forward Current (Per Diode)

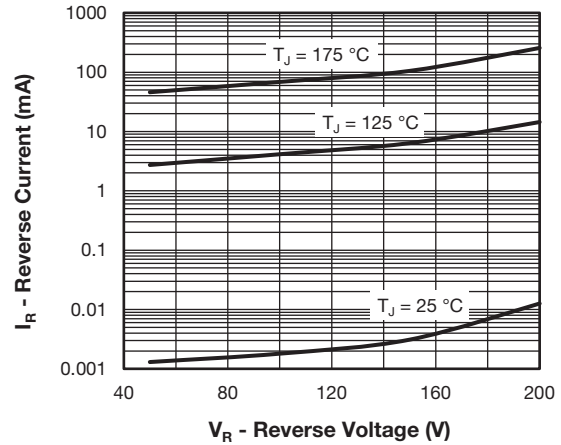

Fig. 2 - Typical Reverse Current vs. Reverse Voltage (Per Diode)

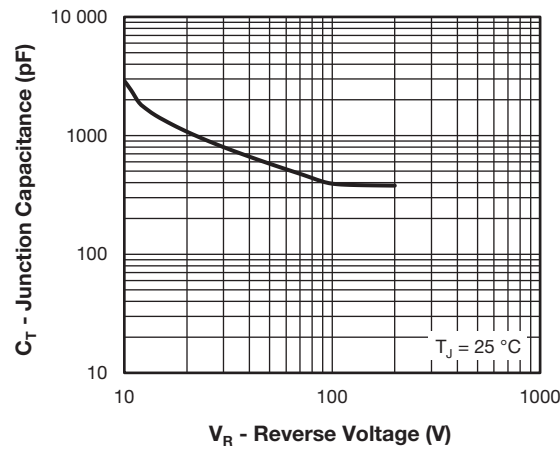

Fig. 3 - Typical Junction Capacitance vs. Reverse Voltage (Per Diode)

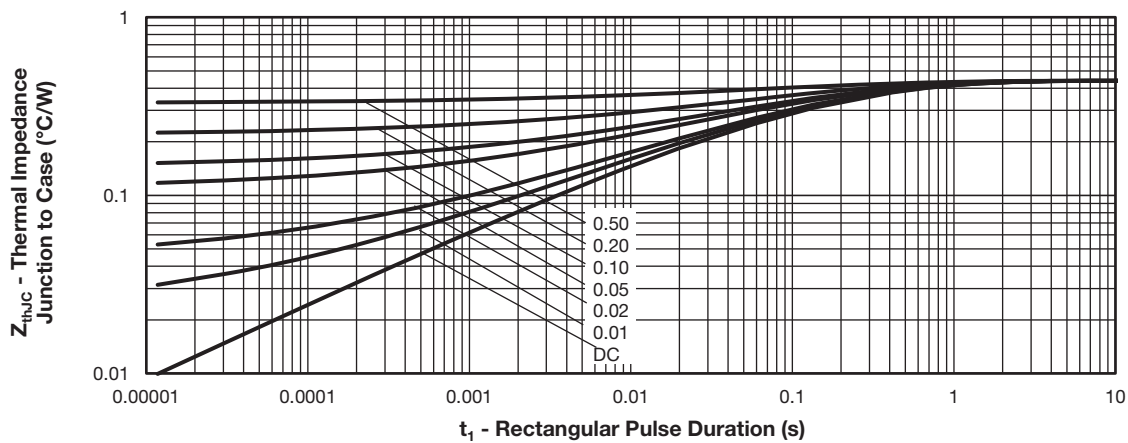

Fig. 4 - Maximum Thermal Impedance  $Z_{thJC}$  Characteristics (Per Diode)

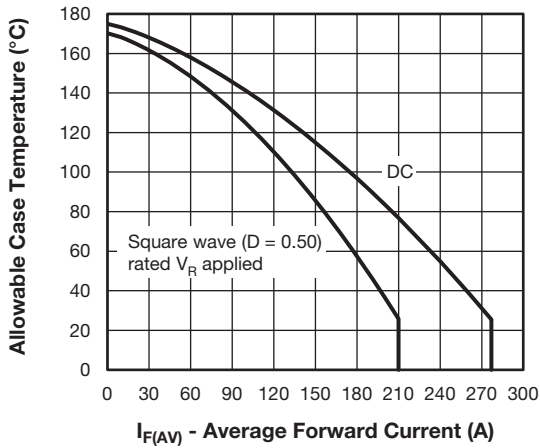

Fig. 5 - Maximum Current Rating Capability (Per Diode)

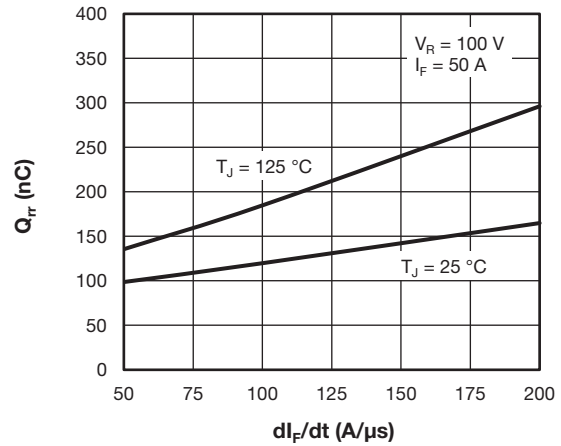

Fig. 7 - Typical Reverse Recovery Charge vs.  $di_F/dt$  (Per Diode)

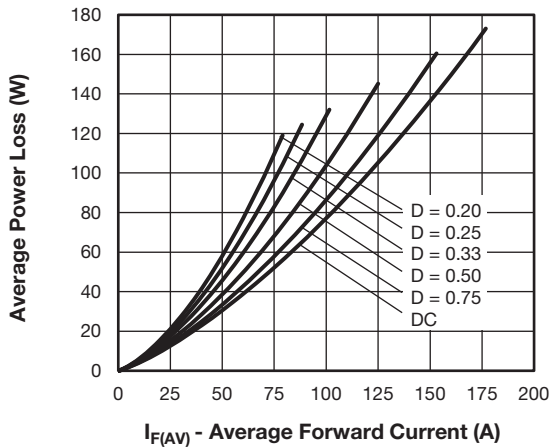

Fig. 6 - Forward Power Loss Characteristics (Per Diode)

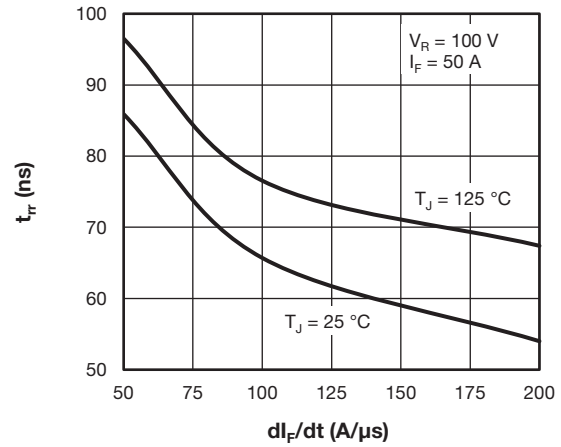

Fig. 8 - Typical Reverse Recovery Time vs.  $di_F/dt$  (Per Diode)

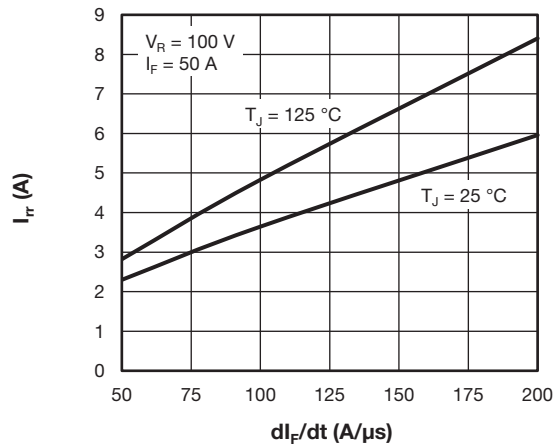

Fig. 9 - Typical Reverse Recovery Current vs.  $di_F/dt$  (Per Diode)

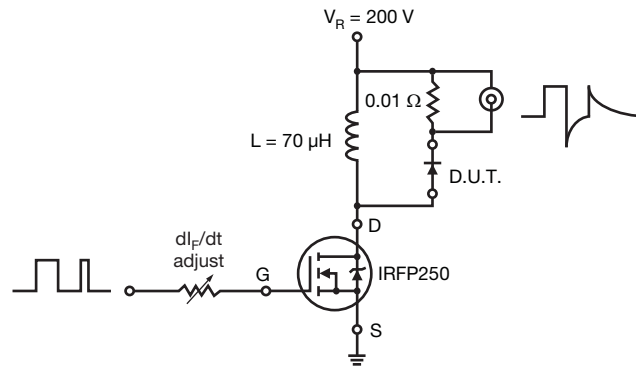
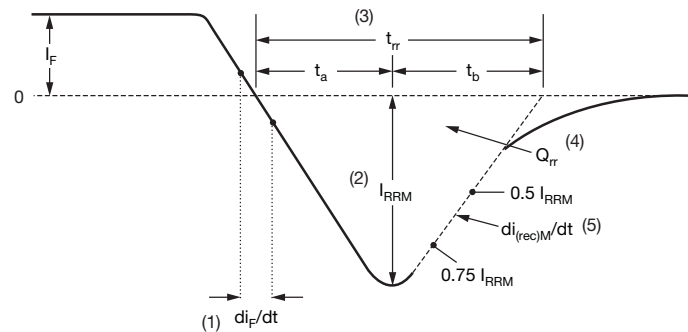

Fig. 10 - Reverse Recovery Parameter Test Circuit



- (1)  $di_F/dt$  - rate of change of current through zero crossing
- (2)  $I_{RRM}$  - peak reverse recovery current
- (3)  $t_{rr}$  - reverse recovery time measured from zero crossing point of negative going  $I_F$  to point where a line passing through  $0.75 I_{RRM}$  and  $0.50 I_{RRM}$  extrapolated to zero current.
- (4)  $Q_{rr}$  - area under curve defined by  $t_{rr}$  and  $I_{RRM}$
- (5)  $di_{(rec)M}/dt$  - peak rate of change of current during  $t_b$  portion of  $t_{rr}$

$$Q_{rr} = \frac{t_{rr} \times I_{RRM}}{2}$$

Fig. 11 - Reverse Recovery Waveform and Definitions

**ORDERING INFORMATION TABLE**

Device code	<b>VS-</b>	<b>Q</b>	<b>A</b>	<b>250</b>	<b>F</b>	<b>A</b>	<b>20</b>
	①	②	③	④	⑤	⑥	⑦

- 1** - Vishay Semiconductors product
- 2** - Schottky technologies
- 3** - Present silicon generation
- 4** - Current rating (250 = 250 A)
- 5** - Circuit configuration (2 separate diodes, parallel pin-out)
- 6** - Package indicator (SOT-227 standard insulated base)
- 7** - Voltage rating (20 = 200 V)

Quantity per tube is 10, M4 screw and washer included



CIRCUIT CONFIGURATION		
CIRCUIT	CIRCUIT CONFIGURATION CODE	CIRCUIT DRAWING
2 separate diodes, parallel pin-out	F	<p>The circuit drawing shows two diodes connected in parallel. The anodes are connected to pins 1 and 2, and the cathodes are connected to pins 3 and 4. A lead assignment diagram to the right shows the physical layout of the diodes on a package with pins 1, 2, 3, and 4.</p>

LINKS TO RELATED DOCUMENTS	
Dimensions	<a href="http://www.vishay.com/doc?95423">www.vishay.com/doc?95423</a>
Packaging information	<a href="http://www.vishay.com/doc?95425">www.vishay.com/doc?95425</a>



# SOT-227 Generation 2

**DIMENSIONS** in millimeters (inches)



**Note**

- Controlling dimension: millimeter



## **Disclaimer**

ALL PRODUCT, PRODUCT SPECIFICATIONS AND DATA ARE SUBJECT TO CHANGE WITHOUT NOTICE TO IMPROVE RELIABILITY, FUNCTION OR DESIGN OR OTHERWISE.

Vishay Intertechnology, Inc., its affiliates, agents, and employees, and all persons acting on its or their behalf (collectively, "Vishay"), disclaim any and all liability for any errors, inaccuracies or incompleteness contained in any datasheet or in any other disclosure relating to any product.

Vishay makes no warranty, representation or guarantee regarding the suitability of the products for any particular purpose or the continuing production of any product. To the maximum extent permitted by applicable law, Vishay disclaims (i) any and all liability arising out of the application or use of any product, (ii) any and all liability, including without limitation special, consequential or incidental damages, and (iii) any and all implied warranties, including warranties of fitness for particular purpose, non-infringement and merchantability.

Statements regarding the suitability of products for certain types of applications are based on Vishay's knowledge of typical requirements that are often placed on Vishay products in generic applications. Such statements are not binding statements about the suitability of products for a particular application. It is the customer's responsibility to validate that a particular product with the properties described in the product specification is suitable for use in a particular application. Parameters provided in datasheets and / or specifications may vary in different applications and performance may vary over time. All operating parameters, including typical parameters, must be validated for each customer application by the customer's technical experts. Product specifications do not expand or otherwise modify Vishay's terms and conditions of purchase, including but not limited to the warranty expressed therein.

Hyperlinks included in this datasheet may direct users to third-party websites. These links are provided as a convenience and for informational purposes only. Inclusion of these hyperlinks does not constitute an endorsement or an approval by Vishay of any of the products, services or opinions of the corporation, organization or individual associated with the third-party website. Vishay disclaims any and all liability and bears no responsibility for the accuracy, legality or content of the third-party website or for that of subsequent links.

Except as expressly indicated in writing, Vishay products are not designed for use in medical, life-saving, or life-sustaining applications or for any other application in which the failure of the Vishay product could result in personal injury or death. Customers using or selling Vishay products not expressly indicated for use in such applications do so at their own risk. Please contact authorized Vishay personnel to obtain written terms and conditions regarding products designed for such applications.

No license, express or implied, by estoppel or otherwise, to any intellectual property rights is granted by this document or by any conduct of Vishay. Product names and markings noted herein may be trademarks of their respective owners.