



SPECIFICATION SHEET

SPECIFICATION SHEET NO.	N0626- KBU8100000L80A
DATE	June. 26, 2021
REVISION	A1
DESCRIPTION	Thru Hole Silicon Bridge Rectifier, KBU Series, KBU810 Type, 4 Pins, Reverse Voltage 1000V Max. Forward Current 8A Max. Operating Temp. Range -55°C ~+150°C, Package in Bulk, 400pcs/Box RoHS/RoHS III compliant
CUSTOMER	
CUSTOMER PART NUMBER	
CROSS REF. PART NUMBER	
ORIGINAL PART NUMBER	MDD KBU810
PART CODE	KBU8100000L80A

VENDOR APPROVE			
Issued/Checked/Approved			
DATE: June 26, 2021			

CUSTOMER APPROVE
DATE:

THRU HOLE BRIDGE RECTIFER KBU SERIES

MAIN FEATURE

- The plastic package has Underwrite Laboratory Flammability Classification 94V-0
- Low reverse leakage
- High forward surge current capability
- High temperature soldering guaranteed: 260/10 sec. 0.375" lead length, 5 lbs tension



APPLICATION

- For printed circuit board

RFQ

[Request For Quotation](#)

PART CODE GUIDE

KBU	8100000	L	80A
1	2	3	4

- 1) **KBU**: Thru Hole Silicon Bridge Rectifier, KBU Series, 4 Pins
- 2) **8100000**: Type code for original part number KBU810
- 3) **L**: Package code, In Bulk, 400pcs/Box.
- 4) **810**: Specification code for Reverse Voltage 1000V Max. Forward Current 8A Max

MORE ITEMS AVAILABLE

KBU8005000L805	KBU8010000L810	KBU8020000L820	KBU8040000L840	KBU8060000L860
KBU8080000L880	KBU8100000L80A			

THRU HOLE BRIDGE RECTIFIER KBU SERIES

DIMENSION (Unit: Inch/mm)

Image for reference

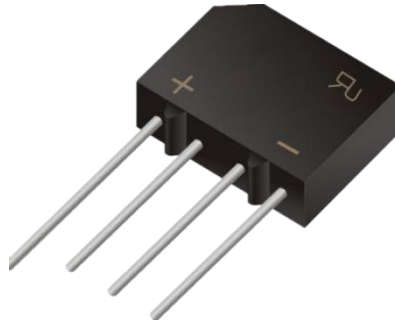

Marking: KBU810

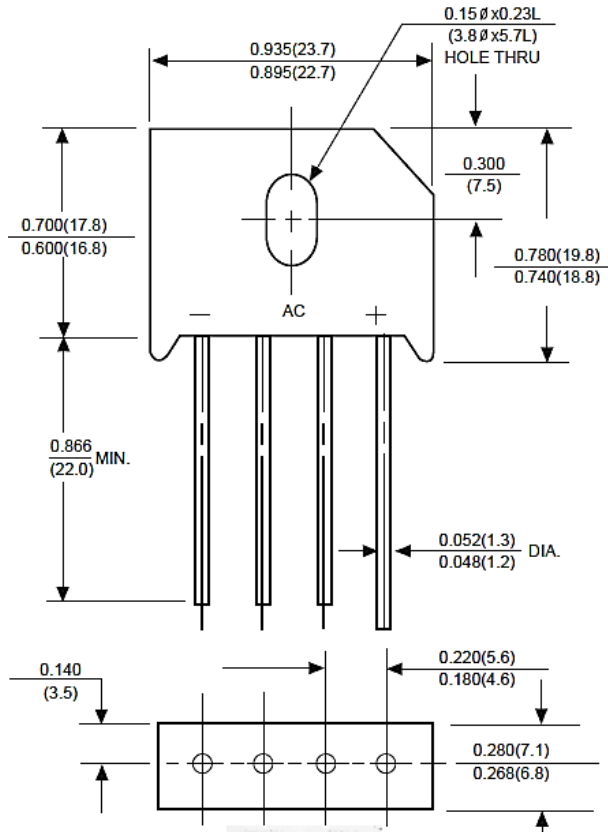

KBU

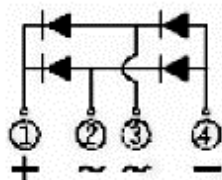

THRU HOLE BRIDGE RECTIFIER KBU SERIES
MECHANICAL DATA

Case	Terminals	Polarity	Mounting Position	Weight per piece
JEDEC KBU molded plastic body	Solder plated, Solderable per MIL-STD-750, Method 2026	Polarity symbol marking on body	Any	0.27 Ounce 7.59 grams

MAX. RATING & CHARACTERISTICS

Parameter	SYMBOLS	VALUE			UNITS
		Min.	Typical	Max.	
Repetitive peak reverse voltage	V _{RRM}			1000	Volts
RMS voltage	V _{RMS}			700	Volts
DC blocking voltage	V _{DC}			1000	Volts
Average forward output rectified current at T _c = 50°C (see Note 2)	I _{AV}			8.0	A
Peak forward surge current 8.3ms single half sine-wave superimposed on rated load (JEDEC Method)	I _{FSM}		200		A
Rating for Fusing (t<8.3ms)	I ² t		-		A ² S
Forward voltage drop per bridge element at 4.0 A	V _F			1.0	Volts
DC reverse current at rated DC blocking voltage	I _R			10	μA
				1.0	mA
Junction capacitance (Note2)	C _J		200		pF
Thermal resistance (Note 3)	R _{QJA}		5.0		°C/W
Operating junction temperature range	T _J	-55		+150	
Storage temperature range	T _{STG}	-55		+150	°C

Note

1. Ratings at 25 C ambient temperature unless otherwise specified. Single phase half-wave 60Hz, resistive or inductive load, for capacitive load current derate by 20%.
2. Measured at 1.0MHz and applied reverse voltage of 4.0V
3. Unit mounted on 3.0"*3.0"*0.11" thick(75*75*30mm) at plate
4. PCB mounted with 0.2"*0.2"(12*12mm) copper pads, 0.375" (9.5mm) lead length

THRU HOLE BRIDGE RECTIFIER KBU SERIES
RELIABILITY

Number	Experiment Items	Experiment Method And Conditions	Reference Documents
1	Solder Resistance Test	Test 260°C± 5°C for 10 ± 2 sec. Immerse body into solder 1/16" ± 1/32"	MIL-STD-750D METHOD-2031.2
2	Solderability Test	230°C ±5°C for 5 sec.	MIL-STD-750D METHOD-2026.1 0
3	Pull Test	1 kg in axial lead direction for 10 sec.	MIL-STD-750D METHOD-2036.4
4	Bend Test	0.5Kg Weight Applied To Each Lead, Bending Arcs 90 °C ± 5 °C For 3 Times	MIL-STD-750D METHOD-2036.4
5	High Temperature Reverse Bias Test	TA=100°C for 1000 Hours at VR=80% Rated VR	MIL-STD-750D METHOD-1038.4
6	Forward Operation Life Test	TA=25°C Rated Average Rectified Current	MIL-STD-750D METHOD-1027.3
7	Intermittent Operation Life Test	On state: 5 min with rated IRMS Power Off state: 5 min with Cool Forced Air. On and off for 1000 cycles.	MIL-STD-750D METHOD-1036.3
8	Pressure Cooker Test	15 PSIG, TA=121°C, 4 hours	MIL-S-19500 APPENOIXC
9	Temperature Cycling Test	-55°C~+125°C; 30 Minutes For Dwelled Time 5 minutes for transferred time. Total: 10 cycles.	MIL-STD-750D METHOD-1051.7
10	Thermal Shock Test	0°C for 5 minutes., 100°C for 5minutes, Total: 10 cycles	MIL-STD-750D METHOD-1056.7
11	Forward Surge Test	8.3ms Single Sale Sine-wave One Surge.	MIL-STD-750D METHOD-4066.4
12	Humidity Test	TA=65°C, RH=98% for 1000 hours.	MIL-STD-750D METHOD-1021.3
13	High Temperature Storage life Test	150°C for 1000 Hours	MIL-STD-750D METHOD-1031.5

THRU HOLE BRIDGE RECTIFIER KBU SERIES

RATINGS AND CHARACTERISTIC CURVES (For Reference Only)

FIG. 1- FORWARD CURRENT DERATING CURVE

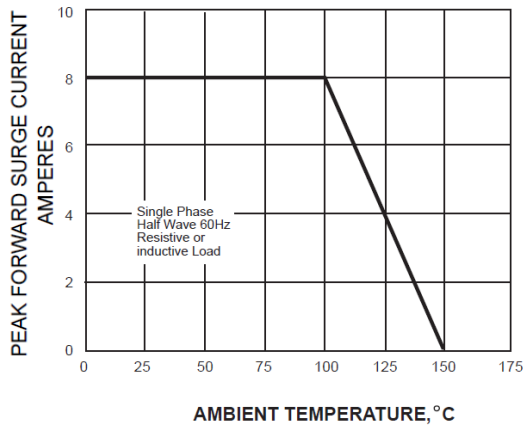

FIG. 2-MAXIMUM NON-REPETITIVE PEAK FORWARD SURGE CURRENT

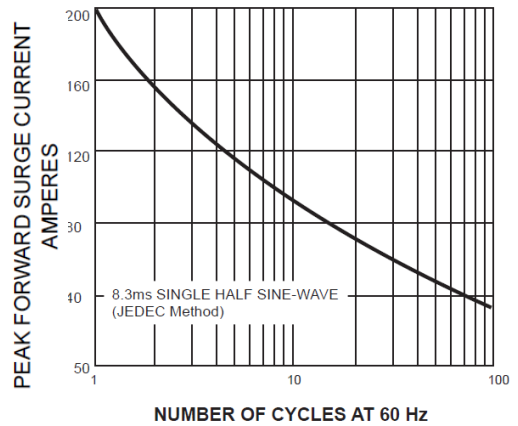

FIG. 3-TYPICAL INSTANTANEOUS FORWARD CHARACTERISTICS

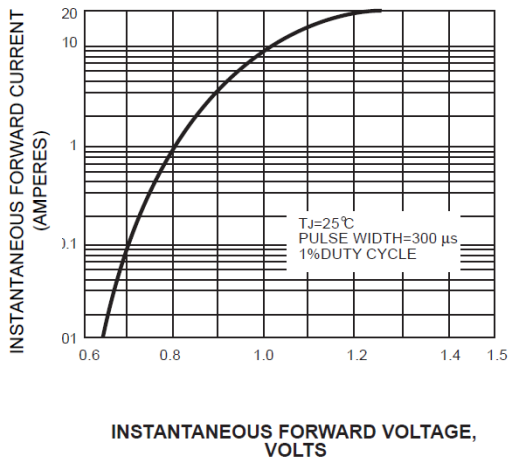

FIG. 4-TYPICAL REVERSE CHARACTERISTICS

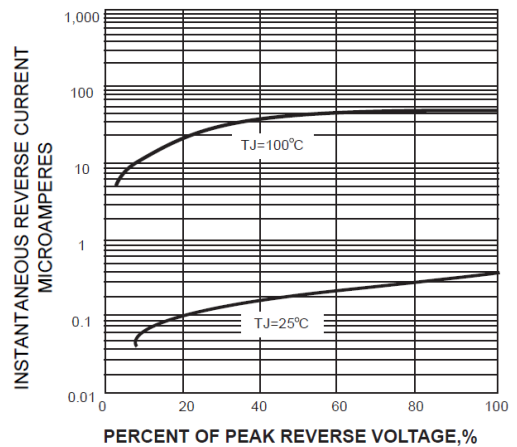

FIG. 5-TYPICAL JUNCTION CAPACITANCE

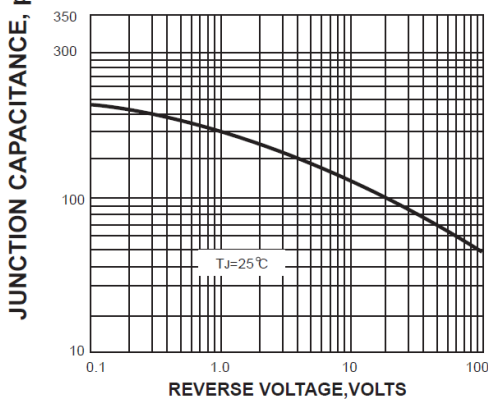
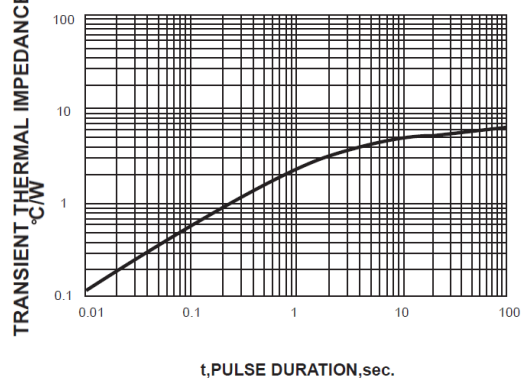

FIG. 6-TYPICAL TRANSIENT THERMAL IMPEDANCE



THRU HOLE BRIDGE RECTIFIER KBU SERIES

PACKAGE

Part Type	Qty. Per Box (pcs)	G.W per box (kg)	Inner Box L*W*H (mm)	Carton size L*W*H (mm)	Qty. Per Carton (pcs)	G. W (kg)
KBU	400	2.9	233*213*55	450*250*190	2400	18.25

DISCLAIMER

NextGen Component, Inc. reserves the right to make changes to the product(s) and or information contained herein without notice. No liability is assumed as a result of their use or application. No rights under any patent accompany the sale of any such product(s) or information