

MOLLY-M

~35° medium beam

TECHNICAL SPECIFICATIONS:

Dimensions	Ø 69.8 mm
Height	23.6 mm
ROHS compliant	yes ⓘ

MATERIAL SPECIFICATIONS:

Component	Type	Material	Colour	Finish
MOLLY-M	Single lens	PMMA	clear	







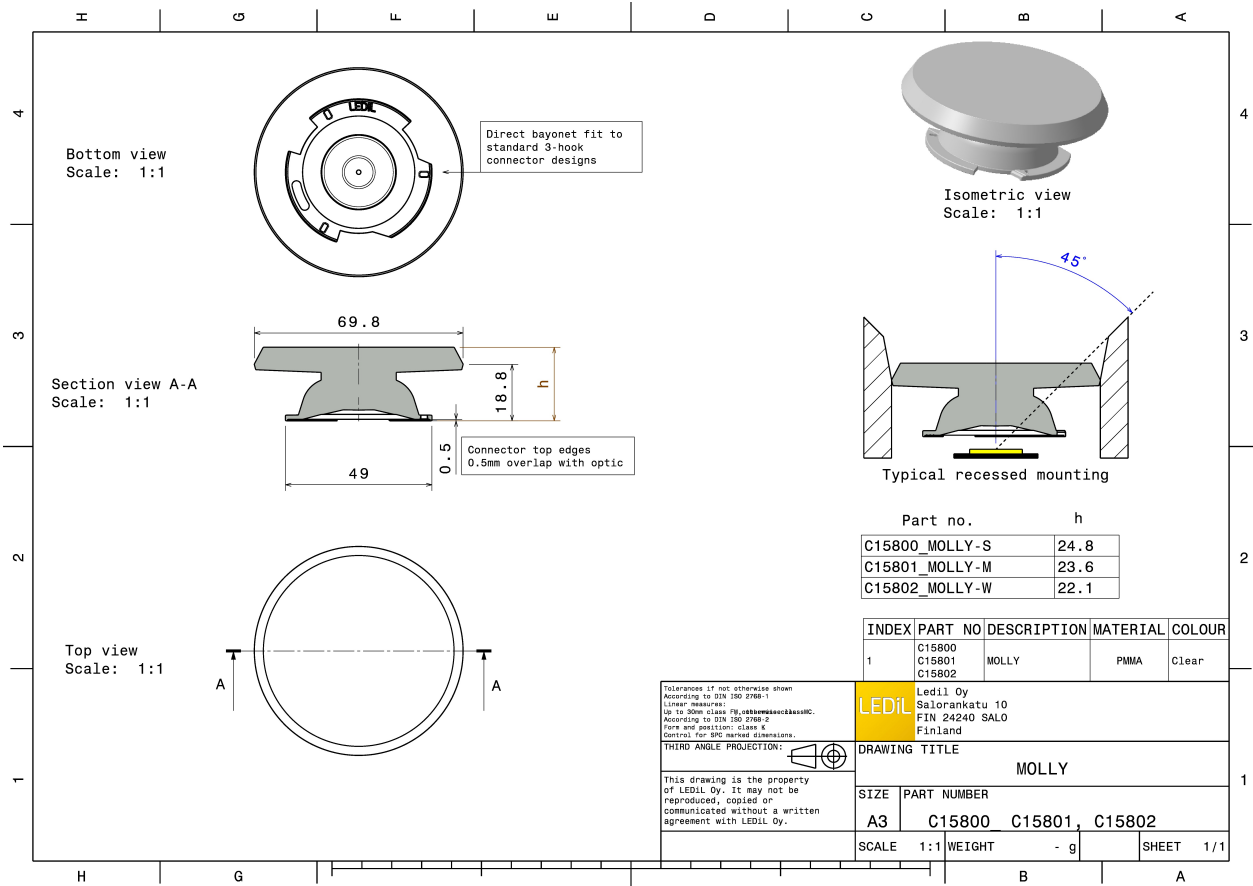



ORDERING INFORMATION:

Component	Qty in box	MOQ	MPQ	Box weight (kg)
C15801_MOLLY-M » Box size: 476 x 273 x 292 mm	198	36	18	9.0

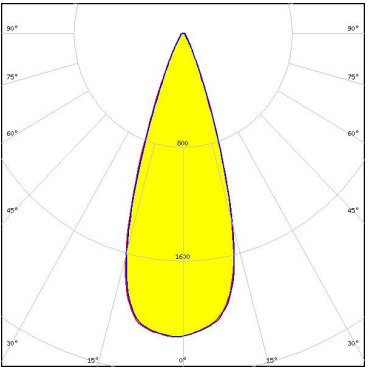

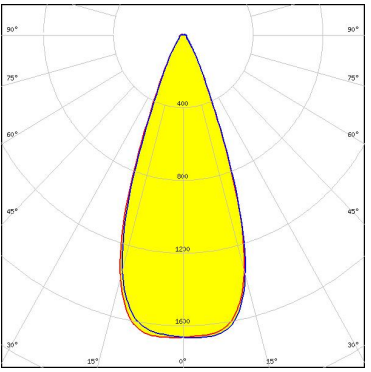
See also our general installation guide: www.ledil.com/installation_guide

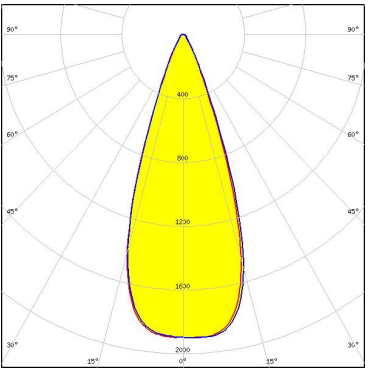
PHOTOMETRIC DATA (MEASURED):

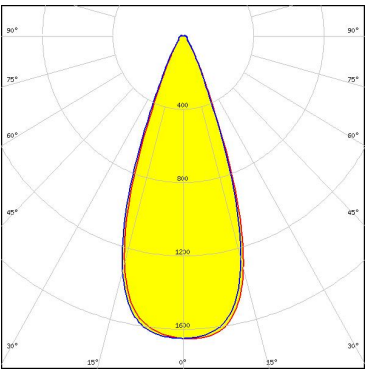
<p></p> <p>LED Vero SE 13</p> <p>FWHM / FWTM 36.0° / 54.0°</p> <p>Efficiency 90 %</p> <p>Peak intensity 2.1 cd/lm</p> <p>LEDs/each optic 1</p> <p>Light colour White</p> <p>Required components: C16402_CLAMP-VEROSE-13-18</p>		
<p></p> <p>LED Vero SE 18</p> <p>FWHM / FWTM 40.0° / 62.0°</p> <p>Efficiency 89 %</p> <p>Peak intensity 1.7 cd/lm</p> <p>LEDs/each optic 1</p> <p>Light colour White</p> <p>Required components: C16402_CLAMP-VEROSE-13-18</p>		
<p></p> <p>LED Vesta TW 15mm DP</p> <p>FWHM / FWTM 38.0° / 58.0°</p> <p>Efficiency 90 %</p> <p>Peak intensity 1.9 cd/lm</p> <p>LEDs/each optic 1</p> <p>Light colour Tunable White</p> <p>Required components: C13658_CLAMP-VERO13-18 Bender Wirth: 482 Typ L2</p>		
<p></p> <p>LED Vesta TW 18mm (31W) DP</p> <p>FWHM / FWTM 40.0° / 61.0°</p> <p>Efficiency 88 %</p> <p>Peak intensity 1.7 cd/lm</p> <p>LEDs/each optic 1</p> <p>Light colour Tunable White</p> <p>Required components: C13584_CLAMP-VERO29 Bender Wirth: 483 Typ L3</p>		

PHOTOMETRIC DATA (MEASURED):

CITIZEN

LED CLL03x/CLU03x
 FWHM / FWTM 36.0° / 55.0°
 Efficiency 89 %
 Peak intensity 2.1 cd/lm
 LEDs/each optic 1
 Light colour White
 Required components:
 Bender Wirth: 433 Typ L1

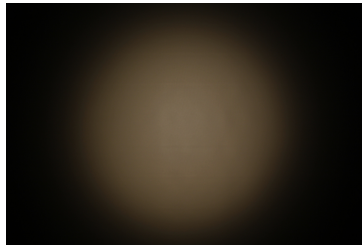

CITIZEN

LED LCN-C02B (Tunable White)
 FWHM / FWTM 35.0° / 53.0°
 Efficiency 89 %
 Peak intensity 2.2 cd/lm
 LEDs/each optic 1
 Light colour White
 Required components:
 C13658_CLAMP-VERO13-18
 Bender Wirth: 481 Typ L2

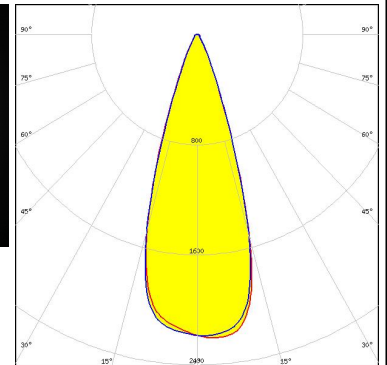

LED CMA1840
 FWHM / FWTM 37.0° / 56.0°
 Efficiency 91 %
 Peak intensity 2 cd/lm
 LEDs/each optic 1
 Light colour White
 Required components:
 C14123_CLAMP-CXA15-18

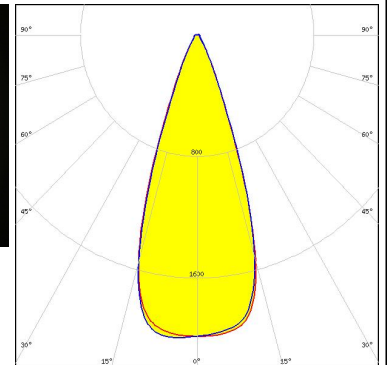

LED CMA2550
 FWHM / FWTM 42.0° / 62.0°
 Efficiency 89 %
 Peak intensity 1.6 cd/lm
 LEDs/each optic 1
 Light colour White
 Required components:
 C14036_CLAMP_CXA25-30

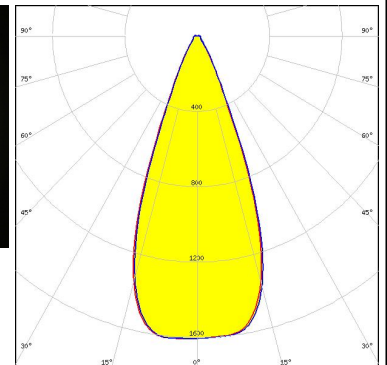
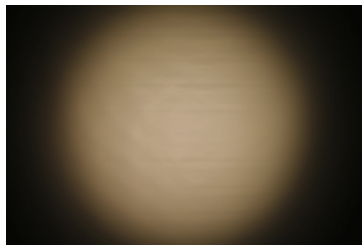

PHOTOMETRIC DATA (MEASURED):

CREE LED

LED CMA3090
 FWHM / FWTM 45.0° / 68.0°
 Efficiency 88 %
 Peak intensity 1.4 cd/m
 LEDs/each optic 1
 Light colour White
 Required components:
 C14036_CLAMP_CXA25-30

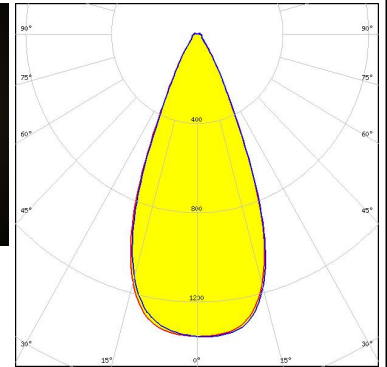
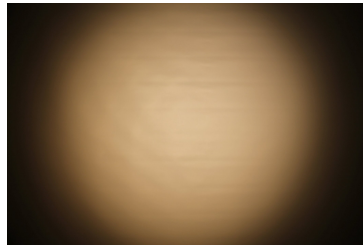

CREE LED

LED CMT14xx
 FWHM / FWTM 33.0° / 50.0°
 Efficiency 90 %
 Peak intensity 2.5 cd/m
 LEDs/each optic 1
 Light colour White
 Required components:
 C13658_CLAMP-VERO13-18
 Bender Wirth: 434 Typ L1

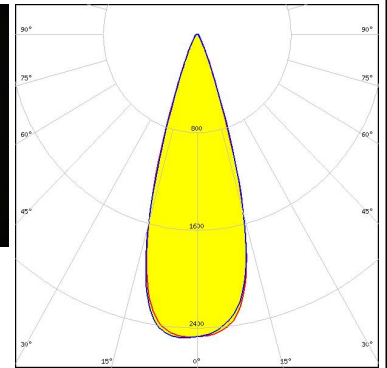
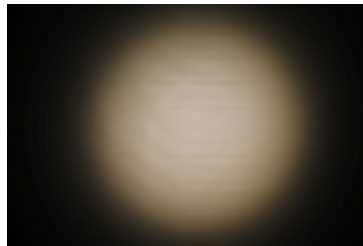

CREE LED

LED CMT19xx
 FWHM / FWTM 36.0° / 55.0°
 Efficiency 90 %
 Peak intensity 2.1 cd/m
 LEDs/each optic 1
 Light colour White
 Required components:
 C13658_CLAMP-VERO13-18
 Bender Wirth: 477 Typ L1

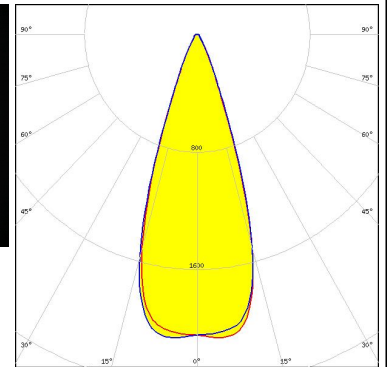
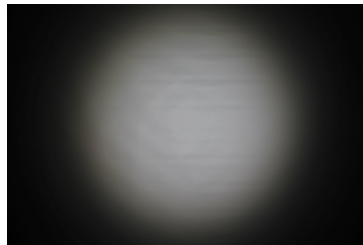

CREE LED

LED CMT28xx
 FWHM / FWTM 42.0° / 65.0°
 Efficiency 87 %
 Peak intensity 1.5 cd/m
 LEDs/each optic 1
 Light colour White
 Required components:
 C13584_CLAMP-VERO29
 Bender Wirth: 471 Typ L3

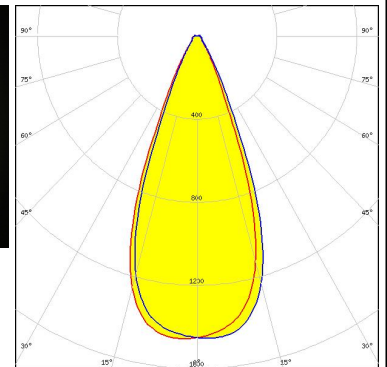
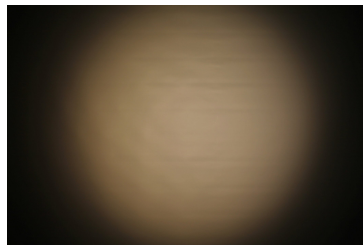

PHOTOMETRIC DATA (MEASURED):



LED CXA/B 15xx
 FWHM / FWTM 34.0° / 51.0°
 Efficiency 90 %
 Peak intensity 2.4 cd/lm
 LEDs/each optic 1
 Light colour White
 Required components:
 C14123_CLAMP-CXA15-18

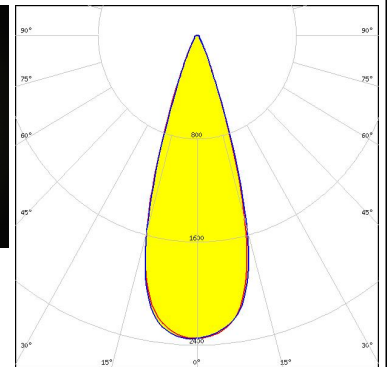

LED LUXEON CoB 1204HD
 FWHM / FWTM 30.0° / 46.0°
 Efficiency 89 %
 Peak intensity 2.9 cd/lm
 LEDs/each optic 1
 Light colour White
 Required components:
 TE Connectivity: 2213382-2 + OPTIC CLIP Z50 TYPE1 2213194-1

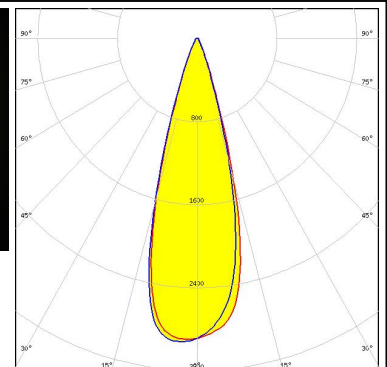
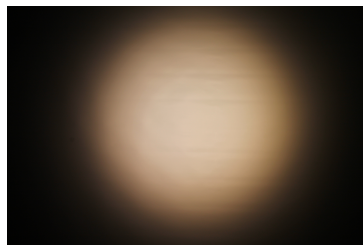

LED CDM-14 (Dim-To-Warm)
 FWHM / FWTM 36.0° / 54.0°
 Efficiency 89 %
 Peak intensity 2 cd/lm
 LEDs/each optic 1
 Light colour White
 Required components:
 C13658_CLAMP-VERO13-18
 Bender Wirth: 491 Typ L2

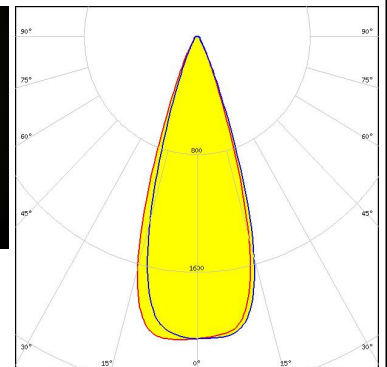
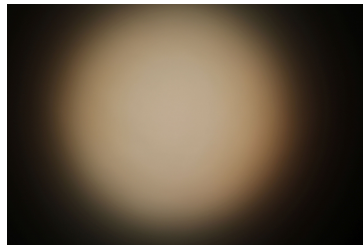

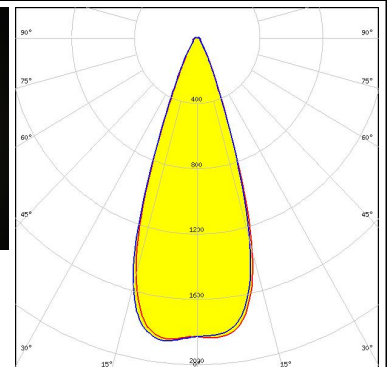
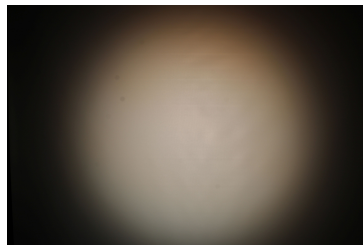

LED CDM-18 (Dim-To-Warm)
 FWHM / FWTM 38.0° / 57.0°
 Efficiency 89 %
 Peak intensity 1.9 cd/lm
 LEDs/each optic 1
 Light colour White
 Required components:
 C13658_CLAMP-VERO13-18
 Bender Wirth: 491 Typ L2

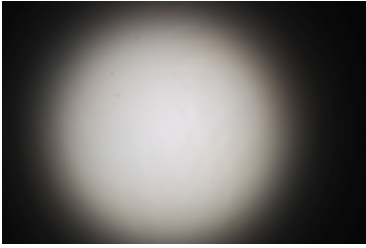
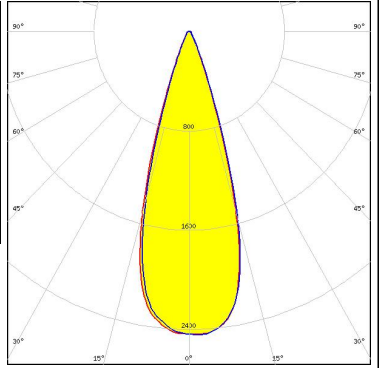
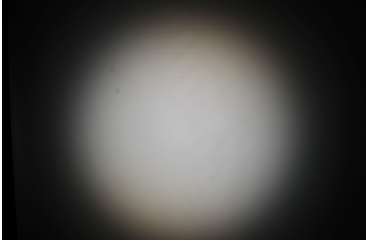
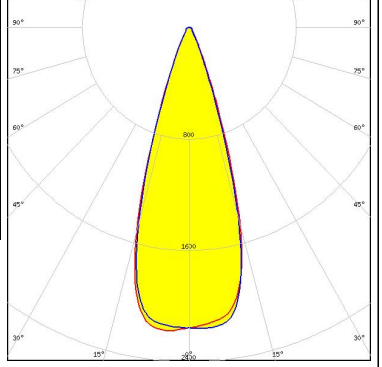
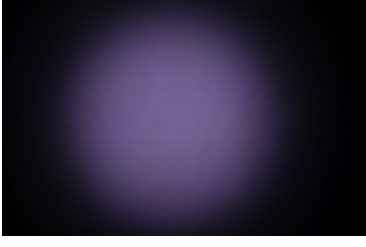
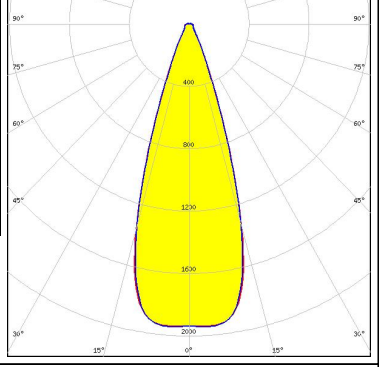
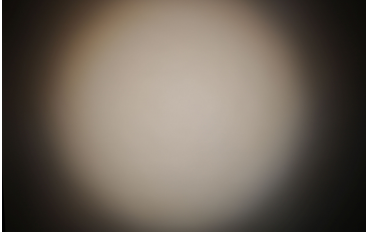
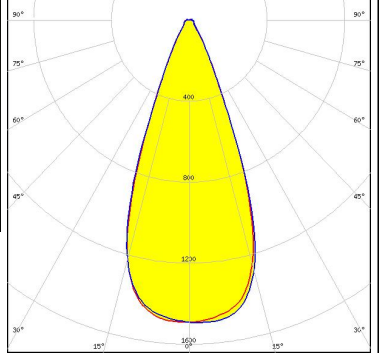

PHOTOMETRIC DATA (MEASURED):

<p>LUMINUS</p> <p>LED CDM-9 (Dim-To-Warm)</p> <p>FWHM / FWTM 33.0° / 49.0°</p> <p>Efficiency 89 %</p> <p>Peak intensity 2.4 cd/lm</p> <p>LEDs/each optic 1</p> <p>Light colour White</p> <p>Required components: C13658_CLAMP-VERO13-18 Bender Wirth: 490 Typ L1</p>		
<p>LUMINUS</p> <p>LED CTM-14 (Tunable White)</p> <p>FWHM / FWTM 34.0° / 52.0°</p> <p>Efficiency 88 %</p> <p>Peak intensity 2.2 cd/lm</p> <p>LEDs/each optic 1</p> <p>Light colour White</p> <p>Required components: C13584_CLAMP-VERO29 Bender Wirth: 442 Typ L3</p>		
<p>LUMINUS</p> <p>LED CTM-14 RGBW</p> <p>FWHM / FWTM 35.0° / 55.0°</p> <p>Efficiency 88 %</p> <p>Peak intensity 2 cd/lm</p> <p>LEDs/each optic 1</p> <p>Light colour RGBW</p> <p>Required components: C13584_CLAMP-VERO29 Bender Wirth: 500 Typ L3-1</p>		
<p>LUMINUS</p> <p>LED CTM-22 (Tunable White)</p> <p>FWHM / FWTM 42.0° / 64.0°</p> <p>Efficiency 87 %</p> <p>Peak intensity 1.5 cd/lm</p> <p>LEDs/each optic 1</p> <p>Light colour White</p> <p>Required components: C13584_CLAMP-VERO29 Bender Wirth: 494 Typ L3</p>		

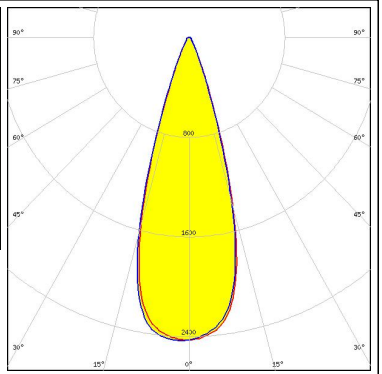
PHOTOMETRIC DATA (MEASURED):

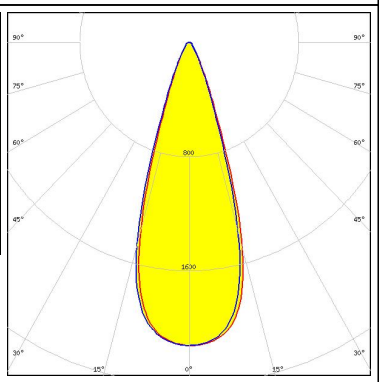
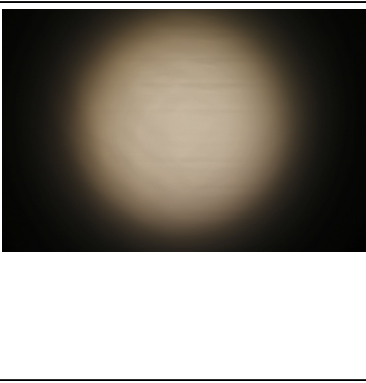
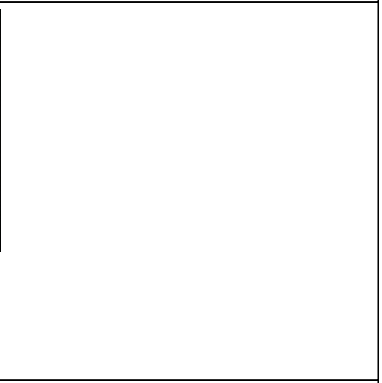
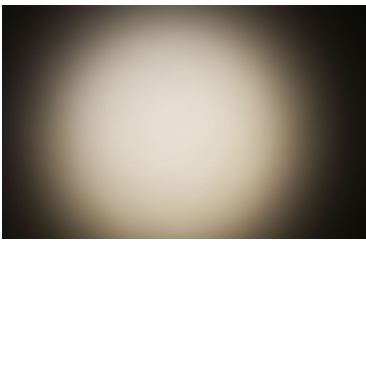
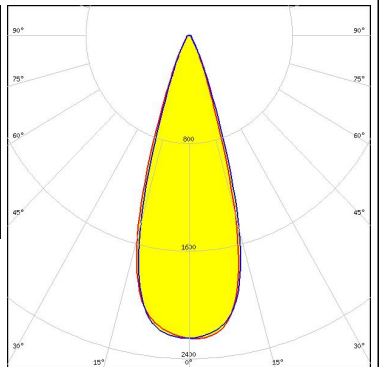
<p>NICHIA</p> <p>LED NVCWJ024Z-V1MT: COB J-Type Tunable White</p> <p>FWHM / FWTM 33.0° / 51.0°</p> <p>Efficiency 89 %</p> <p>Peak intensity 2.4 cd/lm</p> <p>LEDs/each optic 1</p> <p>Light colour White</p> <p>Required components: C13658_CLAMP-VERO13-18 Bender Wirth: 498 Typ L2</p>		
<p>OSRAM</p> <p>LED PrevaLED Core G7 L15 H1</p> <p>FWHM / FWTM 35.0° / 55.0°</p> <p>Efficiency 90 %</p> <p>Peak intensity 2.1 cd/lm</p> <p>LEDs/each optic 1</p> <p>Light colour White</p> <p>Required components: C16685_CLAMP-PRV-A</p>		
<p>PHILIPS</p> <p>LED Fortimo SLM L13 CoB</p> <p>FWHM / FWTM 35.0° / 53.0°</p> <p>Efficiency 89 %</p> <p>Peak intensity 2.2 cd/lm</p> <p>LEDs/each optic 1</p> <p>Light colour White</p> <p>Required components: TE Connectivity: 2213130-2 + OPTIC CLIP Z50 TYPE1 2213194-1</p>		
<p>PHILIPS</p> <p>LED Fortimo SLM L15 + SLM holder</p> <p>FWHM / FWTM 34.0° / 53.0°</p> <p>Efficiency 89 %</p> <p>Peak intensity 2.3 cd/lm</p> <p>LEDs/each optic 1</p> <p>Light colour White</p> <p>Required components: TE Connectivity: OPTIC CLIP Z50 TYPE1 2213194-1</p>		

PHOTOMETRIC DATA (MEASURED):

PHILIPS

LED Fortimo SLM L15 CoB
 FWHM / FWTM 36.0° / 54.0°
 Efficiency 88 %
 Peak intensity 2.1 cd/lm
 LEDs/each optic 1
 Light colour White

Required components:

TE Connectivity: 2213130-2 + OPTIC CLIP Z50 TYPE1 2213194-1

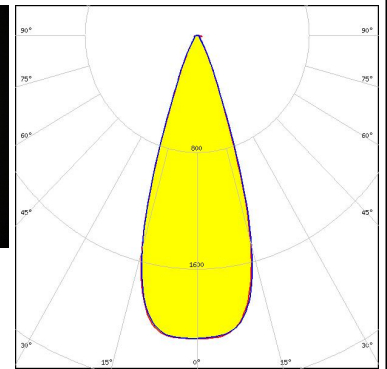

SAMSUNG

LED LC035T (Tunable white)
 FWHM / FWTM 43.0° / 67.0°
 Efficiency 88 %
 Peak intensity 1.4 cd/lm
 LEDs/each optic 1
 Light colour White

Required components:

C13584_CLAMP-VERO29

Bender Wirth: 502 Typ L3

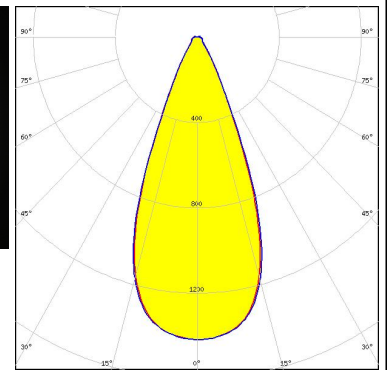
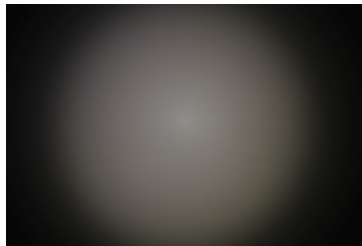

XICATO

LED XTM - 19mm LES
 FWHM / FWTM 39.0° / 60.0°
 Efficiency 90 %
 Peak intensity 1.8 cd/lm
 LEDs/each optic 1
 Light colour White

Required components:

C16491_XTM-ADAPTER-50-A

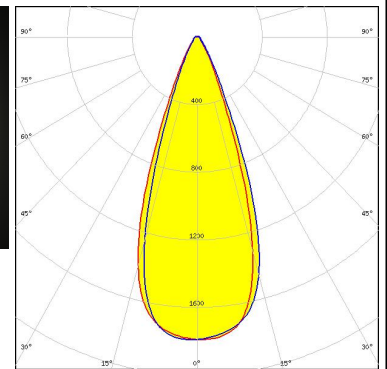
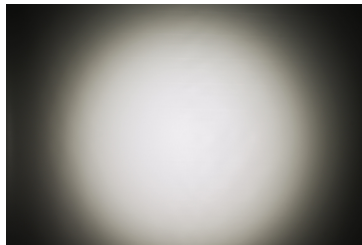

PHOTOMETRIC DATA (SIMULATED):

bridgelux.

LED V9 HD
 FWHM / FWTM 32.0° / 44.0°
 Efficiency 90 %
 Peak intensity 3.3 cd/lm
 LEDs/each optic 1
 Light colour White
 Required components:
 C13658_CLAMP-VERO13-18
 Bender Wirth: 496 Typ L1

bridgelux.

LED VERO13
 FWHM / FWTM 32.0° / 46.0°
 Efficiency 91 %
 Peak intensity 3.1 cd/lm
 LEDs/each optic 1
 Light colour White
 Required components:
 C13658_CLAMP-VERO13-18

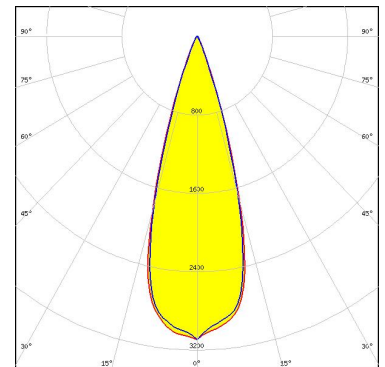

CITIZEN

LED CLL02x/CLU02x (LES10)
 FWHM / FWTM 30.0° / 42.0°
 Efficiency 89 %
 Peak intensity 3.6 cd/lm
 LEDs/each optic 1
 Light colour White
 Required components:
 Bender Wirth: 434 Typ L1

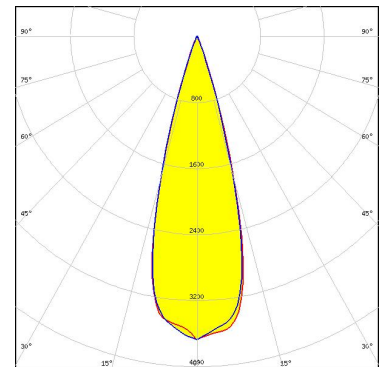

CREE LED

LED CXA/B 1816 & CXA/B 1820 & CXA 1850
 FWHM / FWTM 33.0° / 47.0°
 Efficiency 90 %
 Peak intensity 3.1 cd/lm
 LEDs/each optic 1
 Light colour White
 Required components:
 C14123_CLAMP-CXA15-18

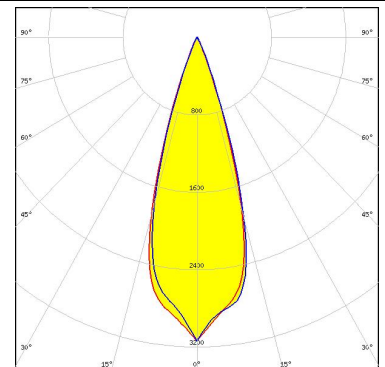

PHOTOMETRIC DATA (SIMULATED):



LED CXA/B 25xx
FWHM / FWTM 36.0° / 50.0°
Efficiency 88 %
Peak intensity 2.2 cd/lm
LEDs/each optic 1
Light colour White
Required components:
C14036_CLAMP_CXA25-30

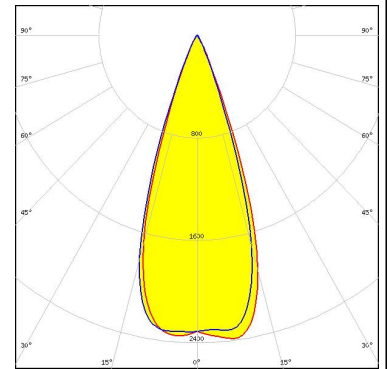

LED CTM-18 (Tunable White)
FWHM / FWTM 34.0° / 47.0°
Efficiency 80 %
Peak intensity 2.3 cd/lm
LEDs/each optic 1
Light colour White
Required components:
C13658_CLAMP-VERO13-18

GENERAL INFORMATION:

NOTE: The typical beam angle will be changed by different color, chip size and chip position tolerance. The typical total beam angle is the full angle measured where the luminous intensity is half of the peak value.

Due to use of high power COB's with this product, special attention to proper thermal design is highly recommended. LEDiL has no liability for direct, indirect or consecutive damages arising from the LEDiL products being used outside of the recommended temperature range.

MATERIALS:

As part of our continuous research and improvement processes, and to ensure the best possible quality and availability of our products, LEDiL reserves the right to change material grades without notice.

PRODUCT DATA USER AGREEMENT AND DISCLAIMER:

The measured data in the provided downloadable LEDiL Product Datasheets and Mechanical 2D-Drawings is rounded and provided as reference for planning. LEDiL Oy's optical specifications have been verified by conducting performance testing of the products in accordance with the company's quality system. The reported data are averaged results of multiple measurements with typical variation. LEDiL Oy reserves the right to without prior notification make changes and improvements to its products.

LEDiL Oy assumes neither warranty, nor guarantee nor any other liability of any kind for the contents and correctness of the provided data. The provided data has been generated with highest diligence but the provided data may in reality not represent the complete possible variation range of all intrinsic parameters. Therefore, in certain cases a deviation from the provided data could occur.

LEDiL Oy reserves the right to undertake technical changes of its products without further notification which could lead to changes in the provided data. LEDiL Oy assumes no liability of any kind for the possible deviation from any provided data or any other damage resulting from the usage of the provided data.

The user agrees to this disclaimer and user agreement with the download or usage of the provided files.

LEDiL Oy

Joensuunkatu 13
FI-24240 SALO
Finland

LEDiL Inc.

228 West Page Street
Suite D
Sycamore IL 60178
USA

Ledil Optics Technology (Shenzhen) Co., Ltd.

405 , Block B
Casic Motor Building
Shenzhen 518057
P.R.CHINA

Local sales and technical support

[www.ledil.com/
where_to_buy](http://www.ledil.com/where_to_buy)

Shipping locations

Salo, Finland
Hong Kong, China

Distribution Partners

[www.ledil.com/
where_to_buy](http://www.ledil.com/where_to_buy)