

SP3030 Series 0.5pF 20kV Unidirectional Discrete TVS

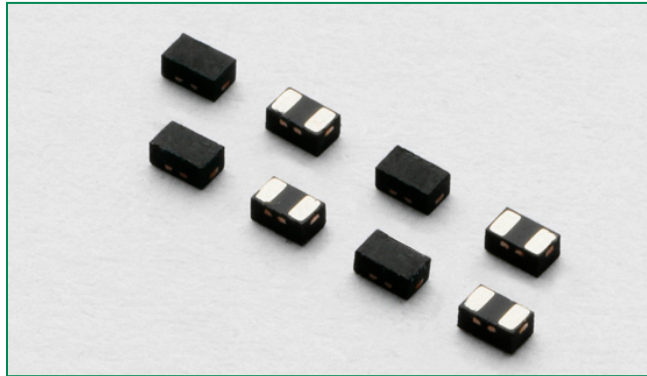

Pinout

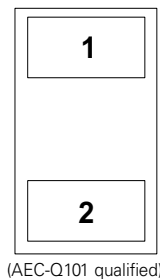

Functional Block Diagram



Life Support Note:

Not Intended for Use in Life Support or Life Saving Applications

The products shown herein are not designed for use in life sustaining or life saving applications unless otherwise expressly indicated.

HDMI Application Example

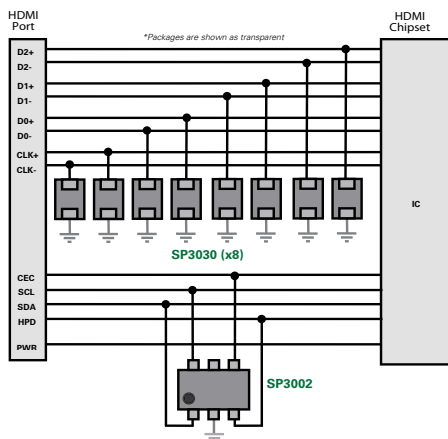

Description

The SP3030 includes low capacitance rail to rail diodes with an additional Zener diode to provide protection for electronic equipment that may experience destructive electrostatic discharges (ESD). These robust diodes can safely absorb repetitive ESD strikes above the maximum level specified in the IEC61000-4-2 international standard ($\pm 20\text{kV}$ contact discharge) without performance degradation. The low loading capacitance makes it ideal for protecting high speed data lines such as HDMI, DVI, USB2.0, USB3.0 and eSATA.

Features

- ESD protection of $\pm 20\text{kV}$ contact discharge, $\pm 30\text{kV}$ air discharge, (IEC61000-4-2)
- EFT protection, IEC61000-4-4, 40A ($t_p=5/50\text{ns}$)
- Lightning Protection, IEC61000-4-5, 3A ($t_p=8/20\mu\text{s}$)
- Low capacitance of 0.5pF @ $V_R=0\text{V}$
- Low leakage current of $0.1\mu\text{A}$ at 5V
- Small SOD882 packaging helps save board space
- AEC-Q101 qualified (SOD882 package)

Applications

- Tablets
- Ultrabook
- eReader
- Smart Phones
- Digital Cameras
- MP3/ PMP
- Set Top Boxes
- Portable Medical

USB3.0 Application Example

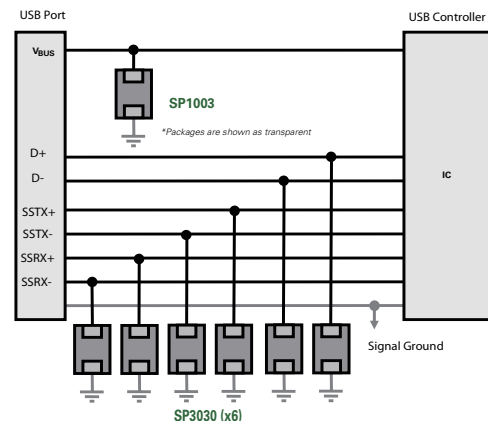

Additional Information



Datasheet



Resources



Samples

Absolute Maximum Ratings

Symbol	Parameter	Value	Units
I_{PP}	Peak Current ($t_p=8/20\mu s$)	3.0	A
T_{OP}	Operating Temperature	-40 to 125	°C
T_{STOR}	Storage Temperature	-55 to 150	°C

CAUTION: Stresses above those listed in "Absolute Maximum Ratings" may cause permanent damage to the device. This is a stress only rating and operation of the device at these or any other conditions above those indicated in the operational sections of this specification is not implied.

Thermal Information

Parameter	Rating	Units
Storage Temperature Range	-55 to 150	°C
Maximum Junction Temperature	150	°C
Maximum Lead Temperature (Soldering 20-40s)	260	°C

Electrical Characteristics ($T_{OP}=25^\circ C$)

Parameter	Symbol	Test Conditions	Min	Typ	Max	Units
Reverse Standoff Voltage	V_{RWM}				5	V
Reverse Leakage Current	I_{LEAK}	$V_R=5V$ with 1pin at GND		0.1	0.5	μA
Clamp Voltage ¹	V_C	$I_{PP}=1A, t_p=8/20\mu s, Fwd$		9.2		V
		$I_{PP}=2A, t_p=8/20\mu s, Fwd$		10.0		V
ESD Withstand Voltage ¹	V_{ESD}	IEC61000-4-2 (Contact)	± 20			kV
		IEC61000-4-2 (Air)	± 30			kV
Dynamic Resistance	R_{DYN}	$(V_{C2}-V_{C1})/(I_{PP2}-I_{PP1})$		0.55		Ω
Diode Capacitance ¹	$C_{I/O-I/O}$	Reverse Bias=0V, f=1 MHz		0.5		pF

Note: 1. Parameter is guaranteed by design and/or device characterization.

Insertion Loss (S21) I/O to GND

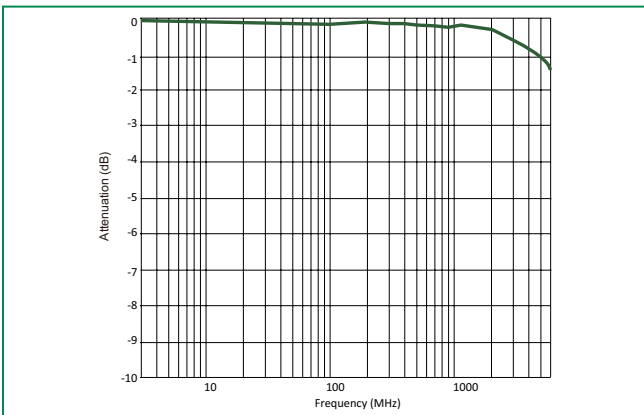

Normalized Capacitance vs. Reverse Voltage

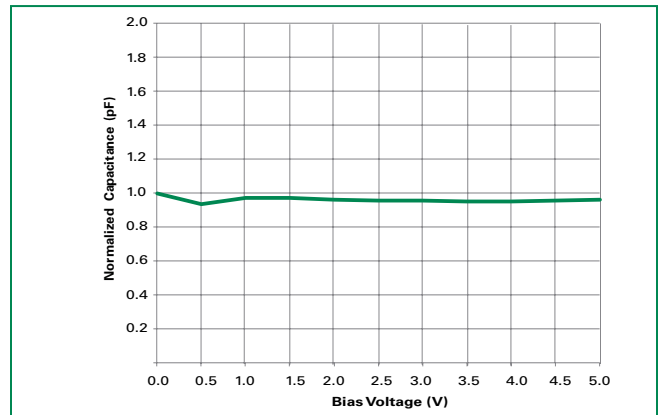

HDMI 1.4 Eye Diagram

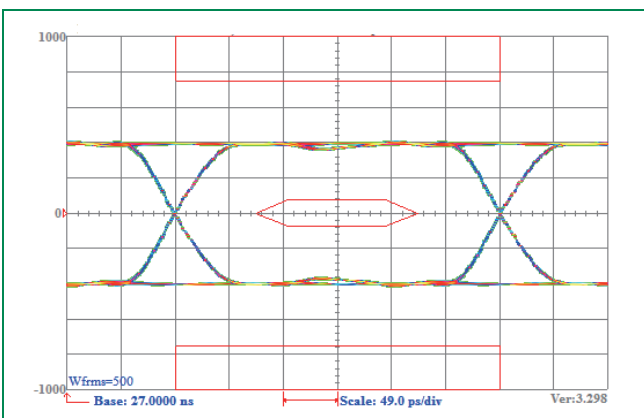

USB3.0 Eye Diagram

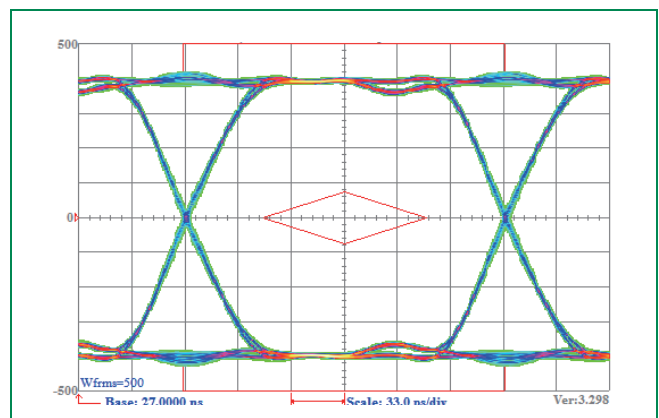

Pulse Waveform

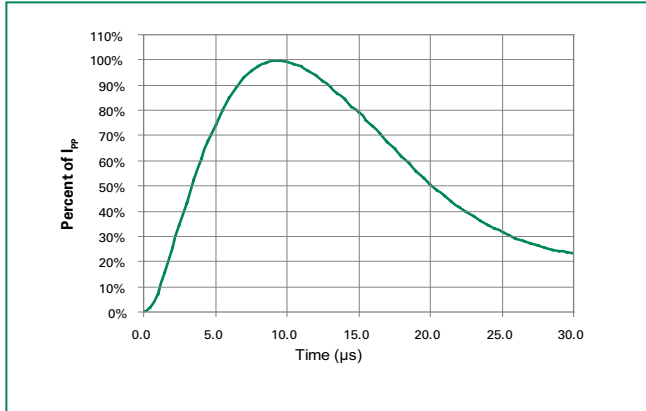

Transmission Line Pulsing (TLP) Plot

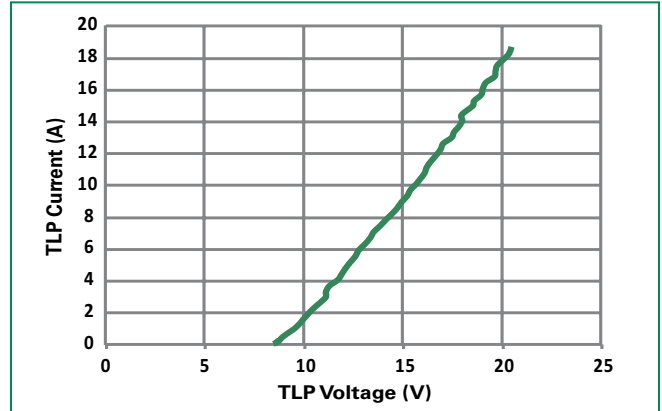

Soldering Parameters

Reflow Condition		Pb – Free assembly
Pre Heat	- Temperature Min ($T_{s(min)}$)	150°C
	- Temperature Max ($T_{s(max)}$)	200°C
	- Time (min to max) (t_s)	60 – 180 secs
Average ramp up rate (Liquidus) Temp (T_L) to peak		3°C/second max
$T_{s(max)}$ to T_L - Ramp-up Rate		3°C/second max
Reflow	- Temperature (T_L) (Liquidus)	217°C
	- Temperature (t_L)	60 – 150 seconds
Peak Temperature (T_p)		260 ^{+0/-5} °C
Time within 5°C of actual peak Temperature (t_p)		20 – 40 seconds
Ramp-down Rate		6°C/second max
Time 25°C to peak Temperature (T_p)		8 minutes Max.
Do not exceed		260°C

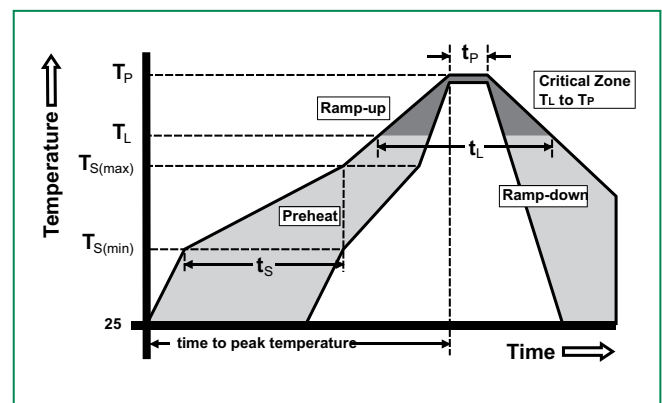

Part Numbering System

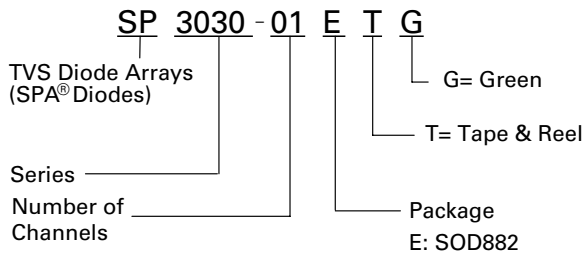

Product Characteristics

Lead Plating	Pre-Plated Frame
Lead Material	Copper Alloy
Lead Coplanarity	0.0004 inches (0.102mm)
Substitute Material	Silicon
Body Material	Molded Epoxy
Flammability	UL 94 V-0

- Notes :
- All dimensions are in millimeters
 - Dimensions include solder plating.
 - Dimensions are exclusive of mold flash & metal burr.
 - Blo is facing up for mold and facing down for trim/form, i.e. reverse trim/form.
 - Package surface matte finish VDI 11-13.

Part Marking System

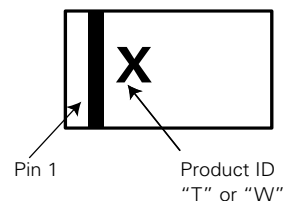

Ordering Information

Part Number	Package	Marking	Packaging Options	P0/P1	Packaging Specifications	Min. Order Qty.
SP3030-01ETG	SOD882	"T" or "W"	Tape & Reel - 8mm tape/7" reel	4mm/2mm	EIA-481	10,000

Package Dimensions — SOD882

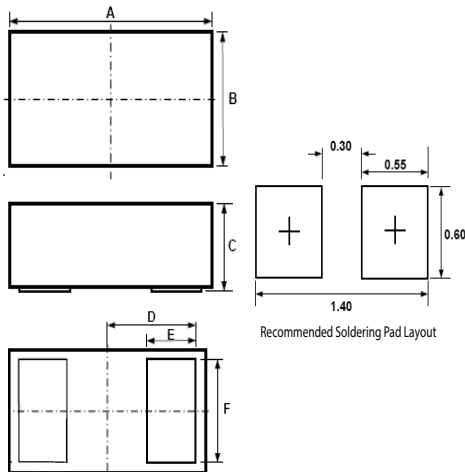

Symbol	Package	SOD882				
	JEDEC	MO-236				
	Millimeters			Inches		
	Min	Typ	Max	Min	Typ	Max
A	0.90	1.00	1.10	0.037	0.039	0.041
B	0.50	0.60	0.70	0.022	0.024	0.026
C	0.40	0.50	0.60	0.016	0.020	0.024
D	0.45			0.018		
E	0.20	0.25	0.35	0.008	0.010	0.012
F	0.45	0.50	0.55	0.018	0.020	0.022

Embossed Carrier Tape & Reel Specification — SOD882

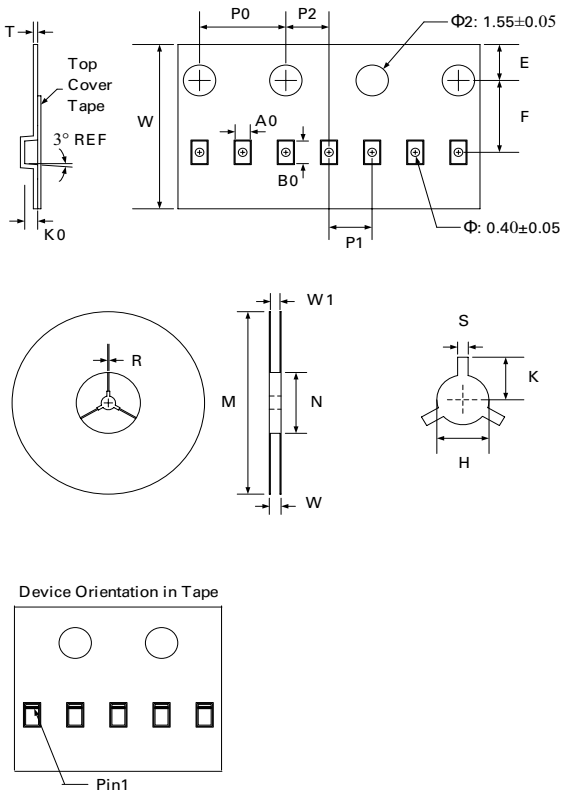

Symbol	Tape Dimensions	
	Millimeters	
	Min	Max
A0	0.65	0.75
B0	1.10	1.20
K0	0.50	0.60
E	1.65	1.85
F	3.45	3.55
P0	3.90	4.10
P1	1.90	2.10
P2	1.95	2.05
T	1.95	2.05
W	7.90	8.10

Symbol	Reel Dimensions (Size Ø 178)	
	Millimeters	
	Min	Max
M	177.0	179.0
N	59.0	61.0
W	11.0	12.0
W1	8.5	9.5
H	12.5	13.5
S	1.9	2.1
K	10.8	11.2
R	0.95	1.05

Disclaimer Notice - Information furnished is believed to be accurate and reliable. However, users should independently evaluate the suitability of and test each product selected for their own applications. Littelfuse products are not designed for, and may not be used in, all applications. Read complete Disclaimer Notice at www.littelfuse.com/disclaimer-electronics.