

5G NR/ 4G/ LTE Ceramic Chip Antenna

ACR4006X

Request Samples



Check Inventory



40 x 6 x 5 mm

RoHS/RoHS II Compliant

MSL Level = 3

Features

- Ultra-wide band 600 MHz ~ 6 GHz
- Compact & Low-Profile
- Linear Polarization
- Surface Mount (SMD)
- High efficiency across cellular bands

Applications

- IoT
- M2M
- Robotics
- Wearables
- Smart Home/Building
- Industrial/Medical/Automotive
- 5GNR, CBRS, Private LTE, CAT M & NB-IoT applications

Dimensions

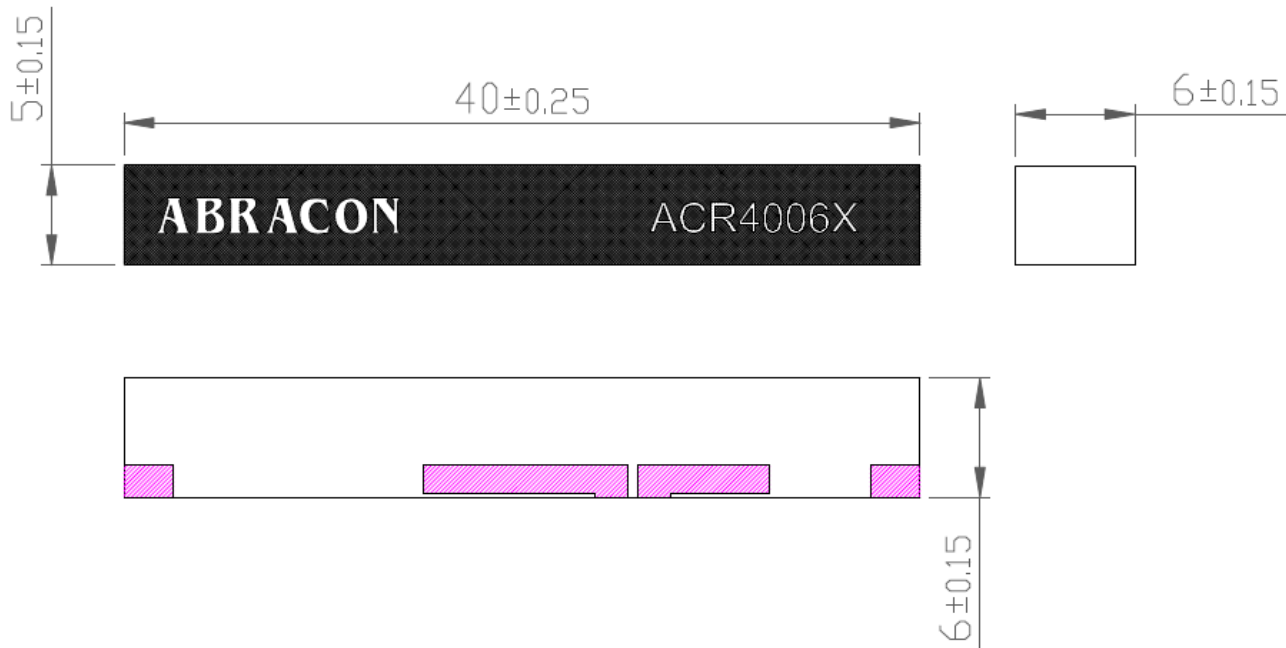

Unit : mm



5101 Hidden Creek Ln Spicewood TX 78669
Phone: 512-371-6159 | Fax: 512-351-8858
For terms and conditions of sales, please visit:
www.abracon.com

REVISED: 10-01-20

ABRACON IS
ISO9001-2015
CERTIFIED

5G NR/ 4G/ LTE Ceramic Chip Antenna

ACR4006X

Request Samples



Check Inventory



40 x 6 x 5 mm

RoHS/RoHS II Compliant

MSL Level = 3

Electrical Specification

Parameter		Specification
Operating Frequency		600 ~ 960, 1710 ~ 2690, 3300 ~ 6000 MHz
Polarization		Linear
Impedance		50 Ω
Bands Supported	5G NR	n - 1,2,3,5,6,7,12,14,18,20,25,28,29,30,34,38,39,40,41,48,65,66,70,71,77,78,79,80,81,82,83,84,86,89,90,95
	4G LTE	B - 1,2,3,4,5,7,8,12,13,14,17,18,19,20,25,26,28,29,34,37,38,39,41,42,43,44,48,49,52,65,66,67,68,69,70,71,85
	3G	PCS,DCA,UMTS

Performance Characteristics

Frequency (MHz)	617	698	700	824	960	1800	1900	2100	2600	3500	4500	5500
Efficiency (%)	31.37	51.86	60.03	54.16	65.11	76.02	74.75	77.43	30.07	41.13	61.78	45.83
Average Gain (dBi)	-5.03	-2.85	-2.21	-2.66	-1.86	-1.19	-1.26	-1.11	-5.21	-3.85	-2.09	-3.38
Peak Gain (dBi)	-2.33	0.87	1.26	0.14	0.95	3.56	3.54	4.42	-1.15	0.86	3.59	2.17

Note : All test measurements were conducted on 120 x 45 mm. Performance of the chip antenna will vary relative to the ground plane size in use.

Mechanical Specification

Parameter	Specification	Unit
Antenna Dimension	40 x 6 x 5	mm
Antenna Clearance Space	45 x 13	mm
Evaluation Board size	120 x 45	mm
Solder Termination	Ag (Environmental-Friendly Pb-Free)	

Environmental Specification

Parameter	Specification
Operating Temperature	-40°C to 85°C
Storage Temperature	
Relative Humidity	90% to 95%



5101 Hidden Creek Ln Spicewood TX 78669
 Phone: 512-371-6159 | Fax: 512-351-8858
 For terms and conditions of sales, please visit:
www.abracon.com

REVISED: 10-01-20

ABRACON IS
 ISO9001-2015
 CERTIFIED

5G NR/ 4G/ LTE Ceramic Chip Antenna

ACR4006X

Request Samples



Check Inventory



40 x 6 x 5 mm

RoHS/RoHS II Compliant

MSL Level = 3

Test Measurement – Return Loss

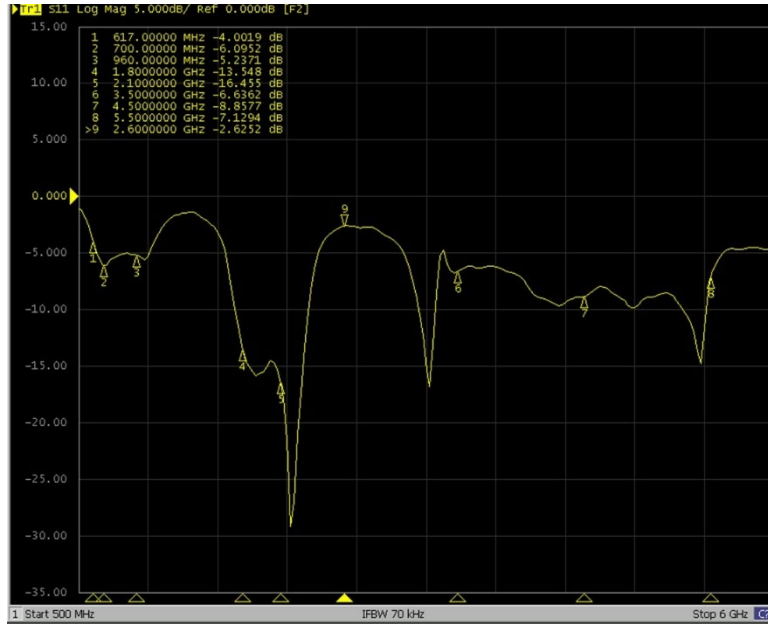

Test Measurement – VSWR

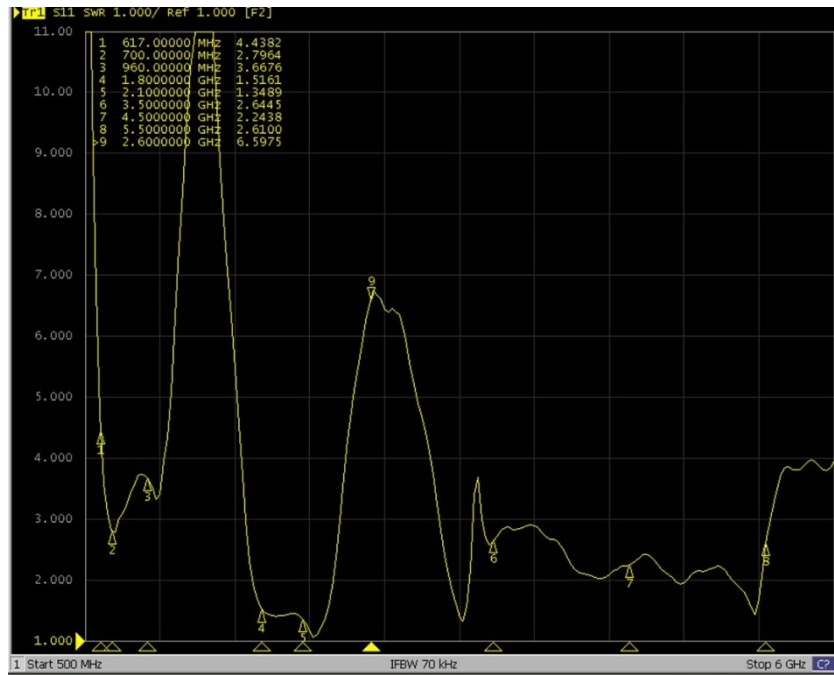

5101 Hidden Creek Ln Spicewood TX 78669
Phone: 512-371-6159 | Fax: 512-351-8858
For terms and conditions of sales, please visit:
www.abracon.com

REVISED: 10-01-20

ABRACON IS
ISO9001-2015
CERTIFIED

5G NR/ 4G/ LTE Ceramic Chip Antenna

ACR4006X

Request Samples



Check Inventory



40 x 6 x 5 mm

RoHS/RoHS II Compliant

MSL Level = 3

Efficiency

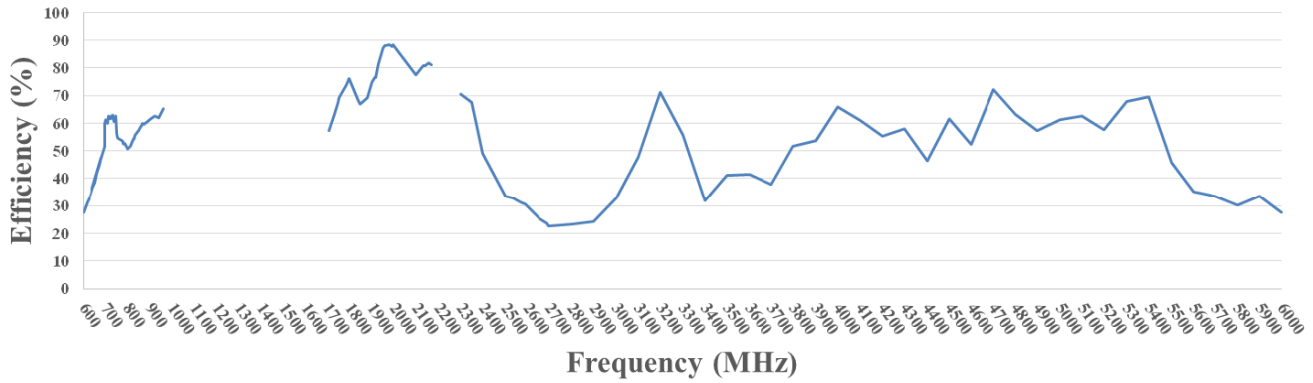

Peak Gain

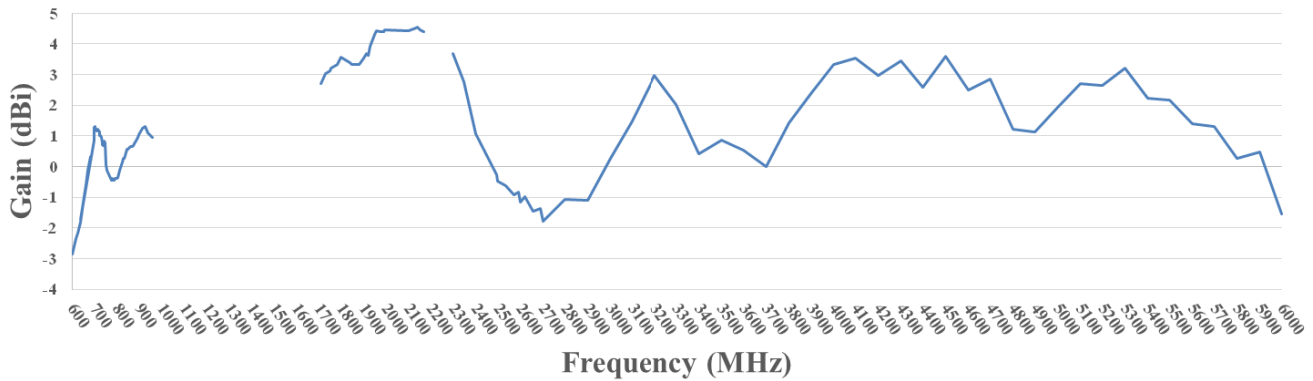

Average Gain

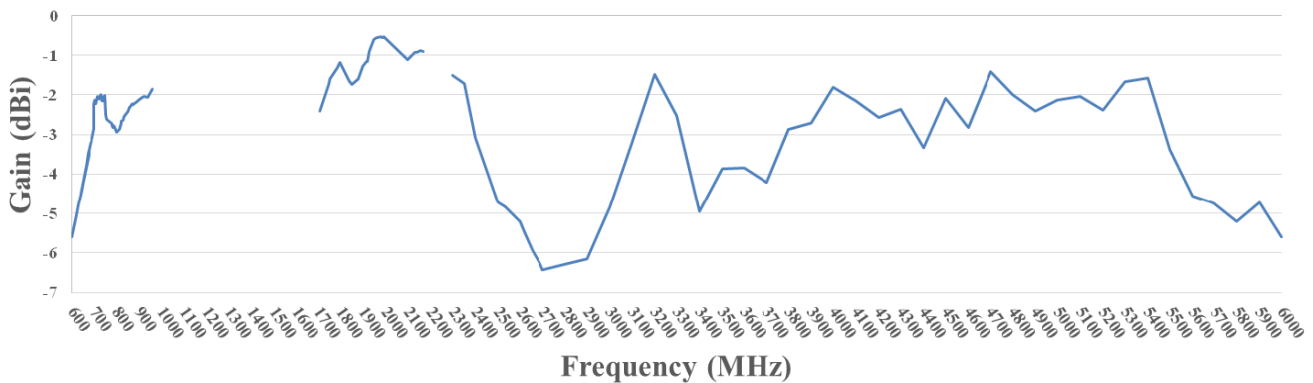

5G NR/ 4G/ LTE Ceramic Chip Antenna

ACR4006X

Request Samples



Check Inventory



40 x 6 x 5 mm

RoHS/RoHS II Compliant

MSL Level = 3

Radiation Pattern

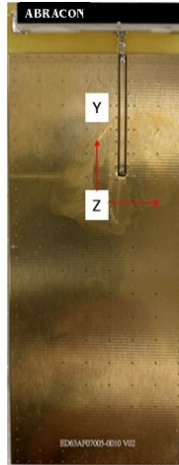

2D Pattern

XY Plane

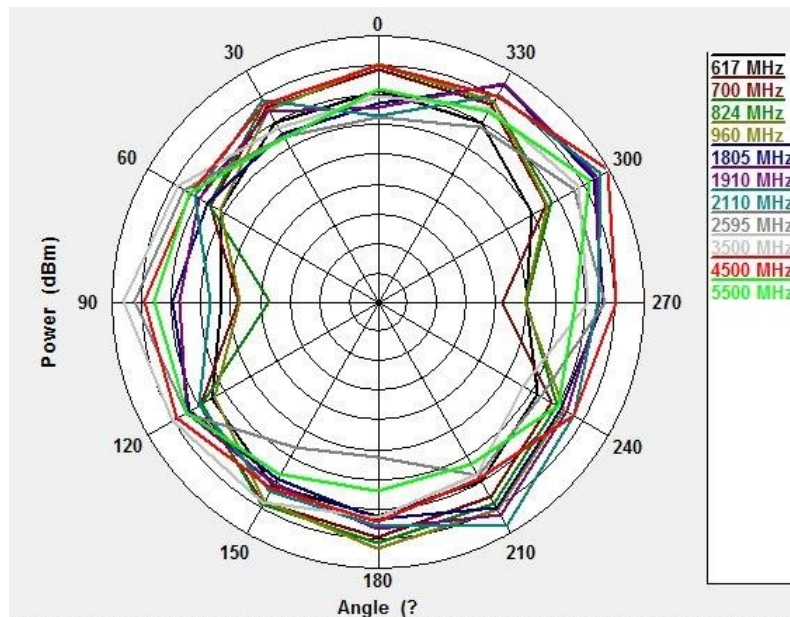

5G NR/ 4G/ LTE Ceramic Chip Antenna

ACR4006X

Request Samples



Check Inventory



40 x 6 x 5 mm

RoHS/RoHS II Compliant

MSL Level = 3

XZ Plane

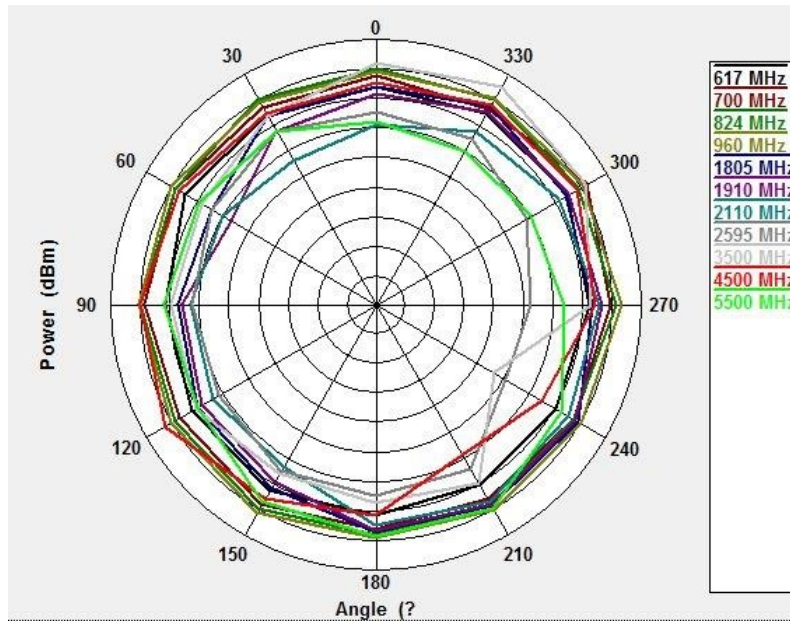

YZ Plane

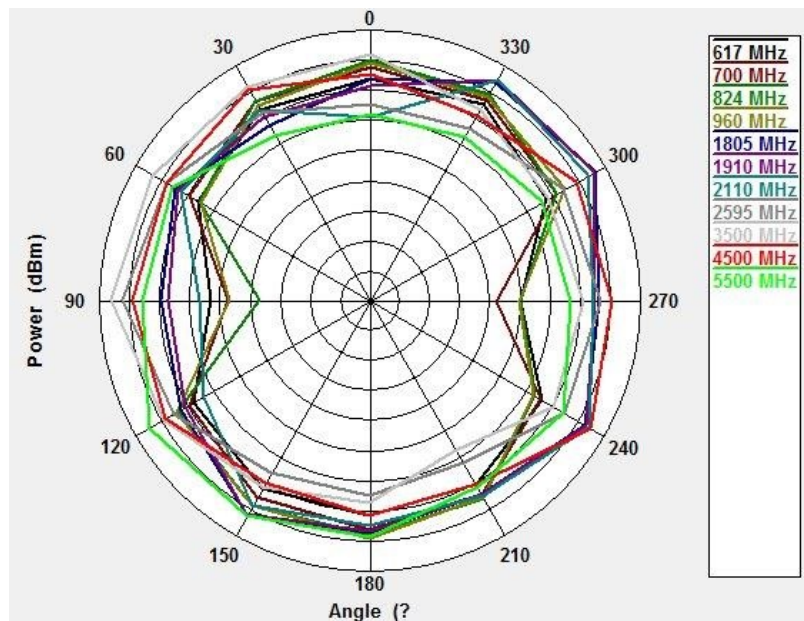

5G NR/ 4G/ LTE Ceramic Chip Antenna

ACR4006X

Request Samples



Check Inventory



40 x 6 x 5 mm

RoHS/RoHS II Compliant

MSL Level = 3

3D Pattern

617 MHz

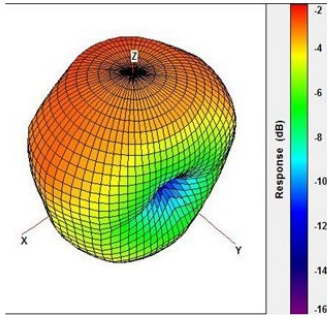

700 MHz

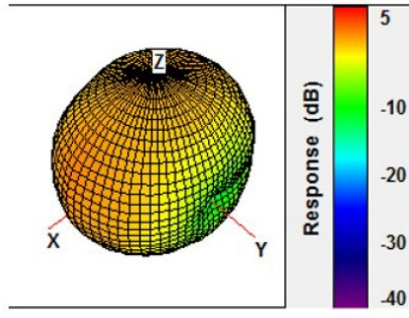

824 MHz

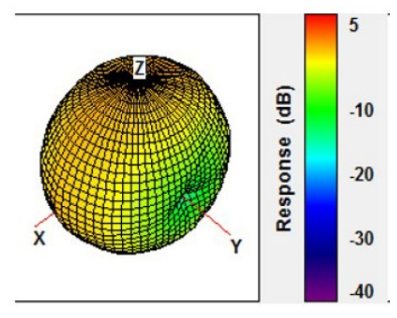

960 MHz

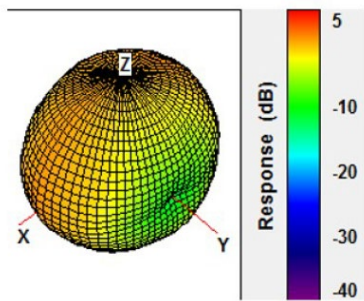

1800 MHz

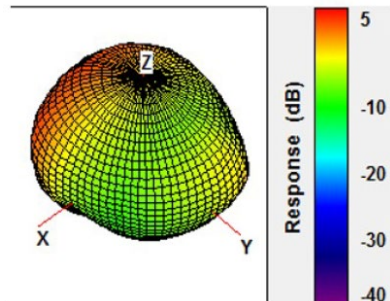

1900 MHz

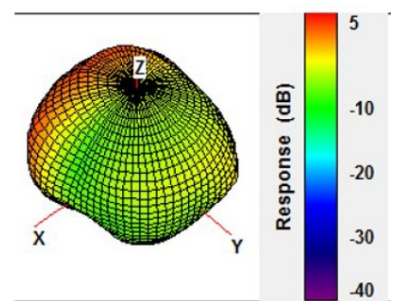

2100 MHz

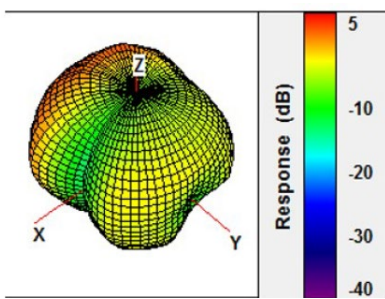

2600 MHz

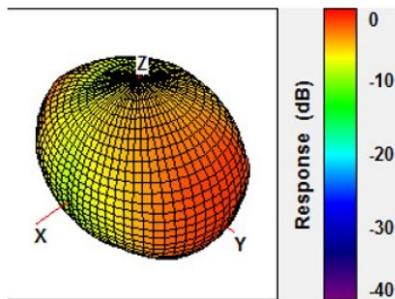

3500 MHz

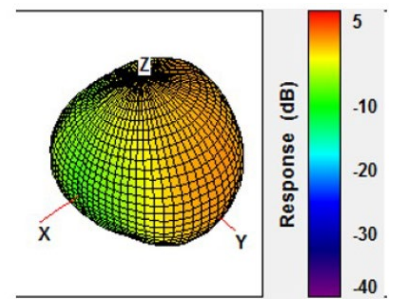

4500 MHz

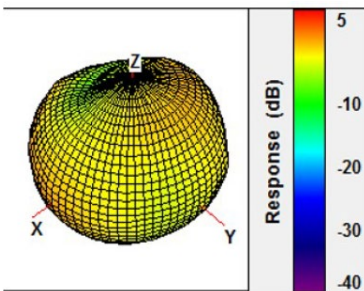

5500 MHz

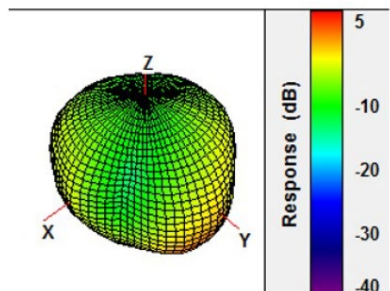

5G NR/ 4G/ LTE Ceramic Chip Antenna

ACR4006X

Request Samples



Check Inventory



40 x 6 x 5 mm

RoHS/RoHS II Compliant

MSL Level = 3

Reliability Tests

Test	Test Condition
Sinusoidal Vibration Test	The device is subject to 5 to 200 to 5Hz swept in 10 minutes, 4.5G at maximum (2mm amplitude), in X and Y directions for two hours each and in Z direction for four hours. After this test, examine its appearance functions.
Vibration Test in Package Condition	The device is subject to vibrations of 15 to 60 to 15 Hz swept in 6 minutes, 4G at maximum (2mm amplitude at maximum), applied in X, Y and Z directions for two hours each, i.e. six hours in total. After this test, examine its appearance functions.
Free Fall Test in packaged condition	Drop the object, which is packaged to a concrete surface from the height of 90 cm, on one corner, three edges and six faces once each, i.e. 10 times in total. After this test, examine its appearance functions.
Solder Heat Resistance Test	The lead pins of the unit are soaked in solder bath at $270\pm 5^{\circ}\text{C}$ for 10 ± 0.5 seconds and then be left for more than 1 hour at $25\pm 5^{\circ}\text{C}$ in less than 65% relative humidity.
Adhesion Test	The device is subjected to be soldered on test PCB. Then apply 0.5Kg (5N) of force for 10 ± 1 second in the direction of parallel to the substrate. (The soldering should be done by reflow and be conducted with care so that the soldering is uniform and free of defect by stress such as heat shock).
Low Temperature Endurance	The device is exposed to the temperature -40°C for 16 hours and then normal temperature/humidity for 24 additional hours. After this test, examine its appearance functions.
High Temperature Endurance	The device is exposed to temperature $+85^{\circ}\text{C}$ for 16 hours and then normal temperature/humidity for 24 hours or more. After this test, examine its appearance functions.
High-Temperature/High-Humidity Test	The device is exposed to the temperature $+85^{\circ}\text{C}$ and 90-95% relative humidity for 96 hours, and then expose it to normal temperature/humidity for 24 additional hours. After this test, examine its appearance functions.
Thermal Shock Test	The device is exposed to a cyclic temperature change (-30°C , 30 minutes ~ $+85^{\circ}\text{C}$, 30 minutes) for 5 cycles, then exposed to normal temperature/humidity for 24 additional hours. After this test, examine its appearance functions.

5G NR/ 4G/ LTE Ceramic Chip Antenna

ACR4006X

Request Samples



Check Inventory



40 x 6 x 5 mm

RoHS/RoHS II Compliant

MSL Level = 3

Reflow Soldering Standard Condition

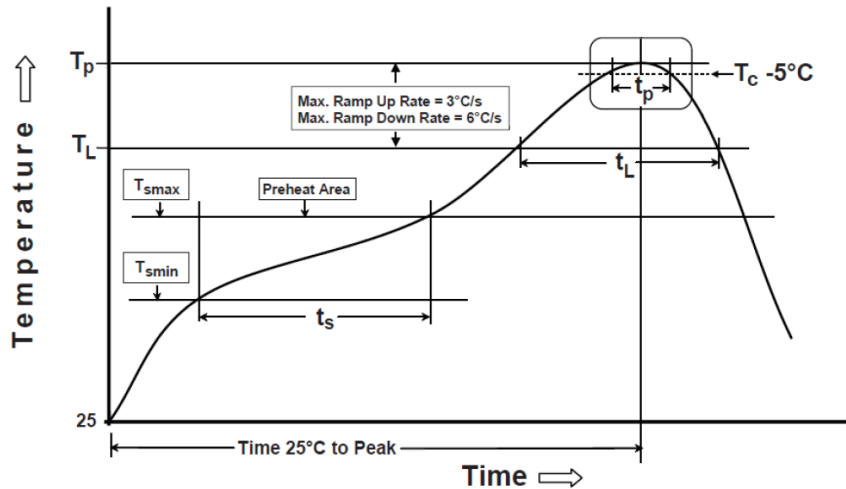

Soldering Condition: Soldering iron temperature 270 ± 10 °C. Apply preheating at 120°C for 2-3 minutes. Finish soldering each terminal within 3 seconds, if the soldering iron is over 270 ± 10 °C or 3 seconds, the component surface will peel or damage.

Phase	Profile features	Pb-Free Assembly (SnAgCu)
PREHEAT	-Temperature Min(T_{smin}) -Temperature Max(T_{smax}) -Time(t_s) from (T_{smin} to T_{smax})	150°C 200°C 60-120 seconds
RAMP-UP	Avg. Ramp-up Rate (T_{smax} to T_P)	3°C/second(max)
REFLOW	-Temperature(T_L) -Total Time above T_L (t_L)	217°C 30-100 seconds
PEAK	-Temperature(T_P) -Time(t_p)	260°C 20-30 second
RAMP-DOWN	Rate	6°C / second max.
Time from 25°C to Peak Temperature		8 minutes max.
Composition of solder paste		96.5Sn/3Ag/0.5Cu
Solder Paste Model		SHENMAO PF606-P26

5G NR/ 4G/ LTE Ceramic Chip Antenna

ACR4006X

Request Samples



Check Inventory



40 x 6 x 5 mm

RoHS/RoHS II Compliant

MSL Level = 3

Transmission Line and Matching

Transmission line and matching

Typical config.1

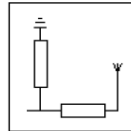

Typical config.2

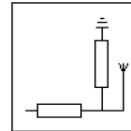

Component types

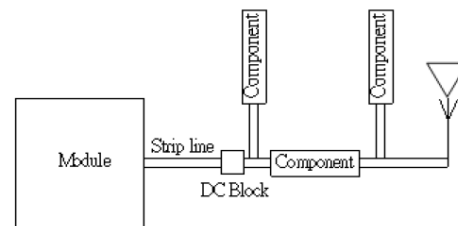
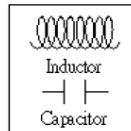

The matching network has to be individually designed using one,two or three components.

Packaging

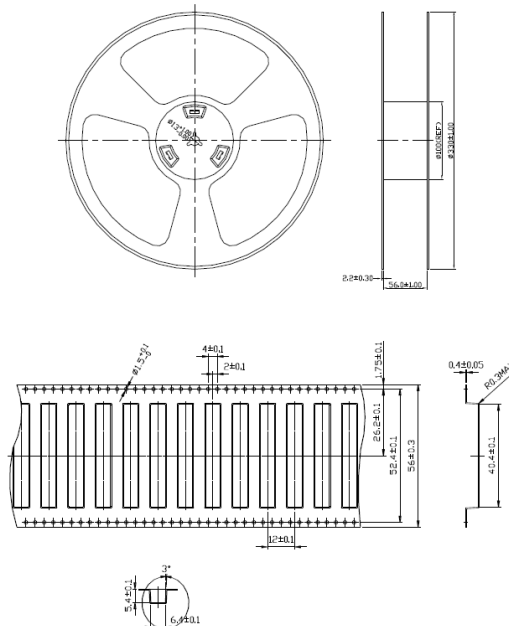

1. Blister tape to IEC 286-3, polyester.
2. Number of pieces per tape: 450
3. Number of pieces per carton : 1350