

1575MHz GPS Ceramic Chip Antenna

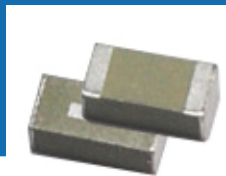

ACAG0301-1575-T

3.2 x 1.6 x 0.6mm



RoHS/RoHS II Compliant

MSL = 1

FEATURES

- High gain of 4.18dBi
- Made using LTCC (low temperature co-fired ceramic) technology
- VSWR ≤ 2.0
- Compact form factor and low profile 3.2 x 1.6 x 0.6mm
- Omni-directional

APPLICATIONS

- GPS/Glonass devices
- IoT and wearables with embedded GPS systems
- Tablets and mobile devices
- Navigation devices
- GPS accessories: USB dongle, SDIO cards, PCMCIA card

ELECTRICAL CHARACTERISTICS

Item	Specification
Frequency (No matching)	1590 MHz
Frequency (after matching)	1575 MHz
Bandwidth	40 MHz typ
VSWR	≤ 2.0
Impedance	50 Ω
Peak Gain	4.18 dBi
Azimuth	Omni-directional
Polarization	Linear
Operating Temperature range	-40°C ~+ 85°C

MECHANICAL DIMENSIONS (mm)

Antenna Dimensions

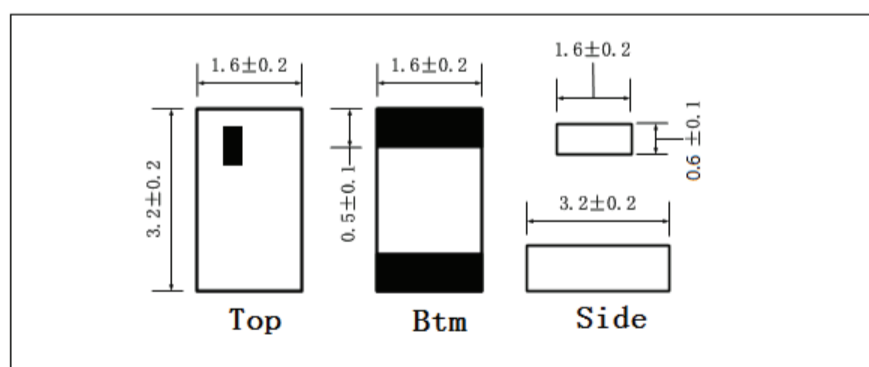

Layout

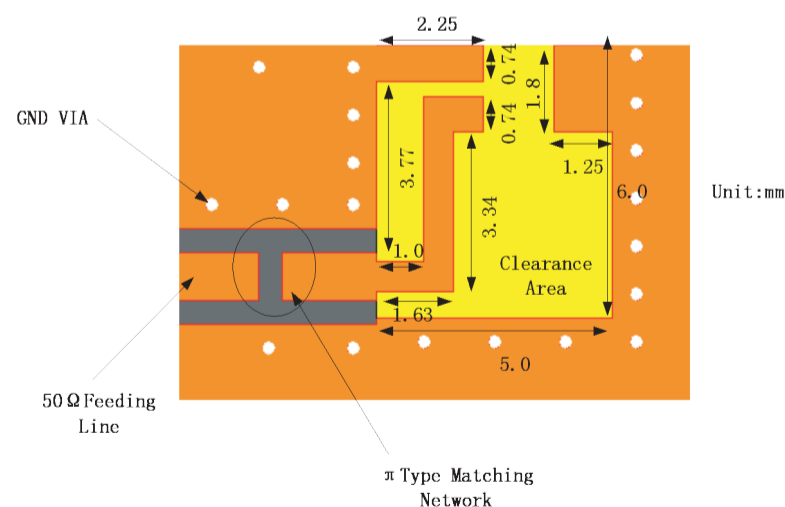

1575MHz GPS Ceramic Chip Antenna



ACAG0301-1575-T



3.2 x 1.6 x 0.6mm
RoHS/RoHS II Compliant
MSL = 1

EVALUATION BOARD AND MATCHING CIRCUITS

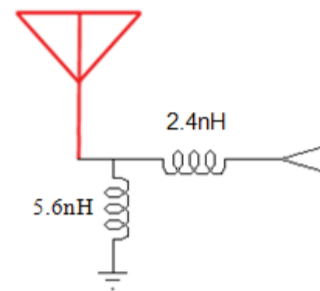
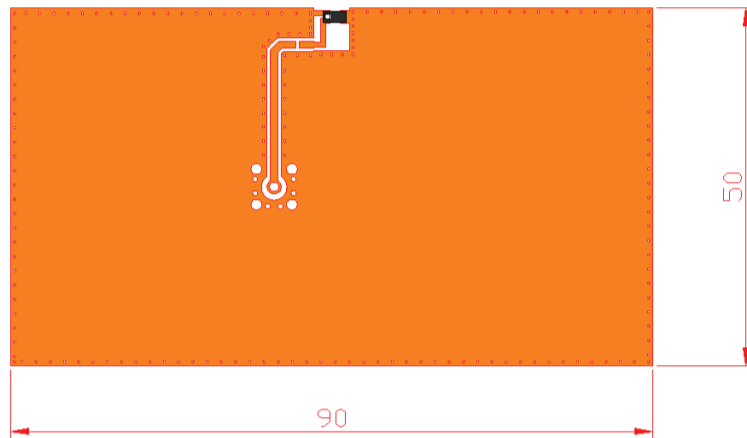

ANTENNA RESPONSE | SMITH CHART AND RETURN LOSS S11

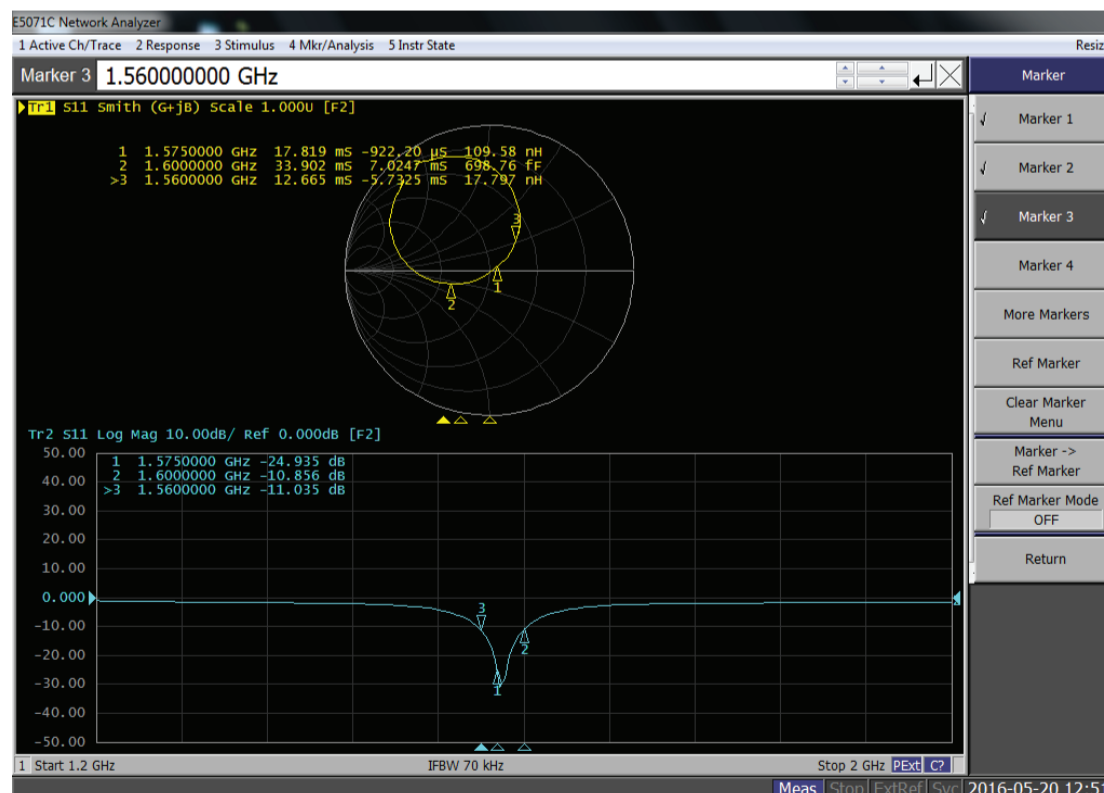

1575MHz GPS Ceramic Chip Antenna



ACAG0301-1575-T

3.2 x 1.6 x 0.6mm



RoHS/RoHS II Compliant

MSL = 1

RADIATION PATTERNS

Coordinates

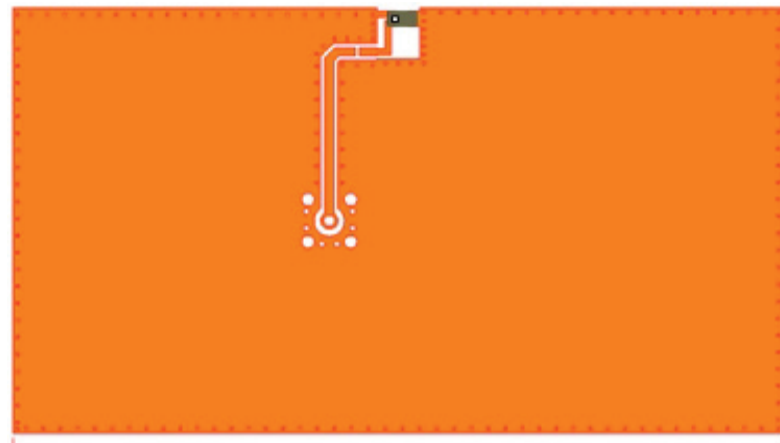
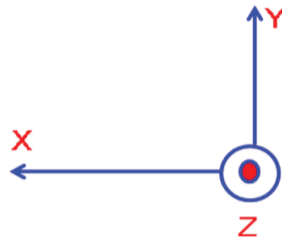

X-Z Plane

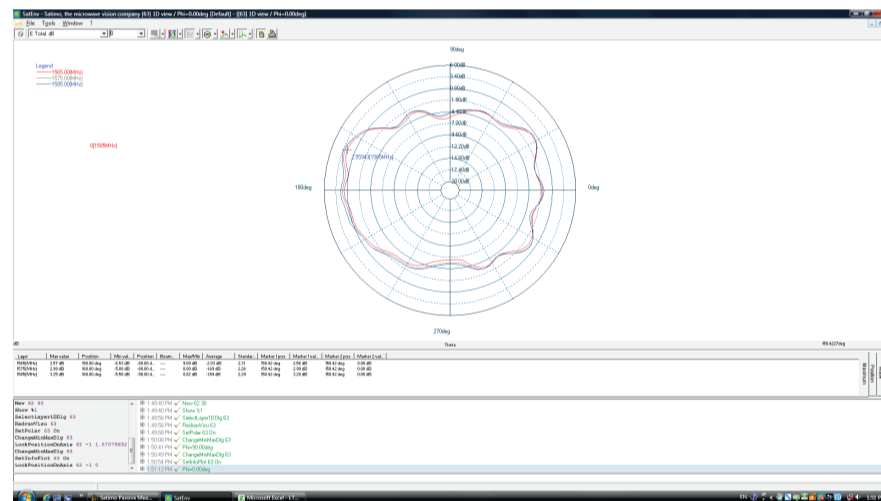

X-Y Plane

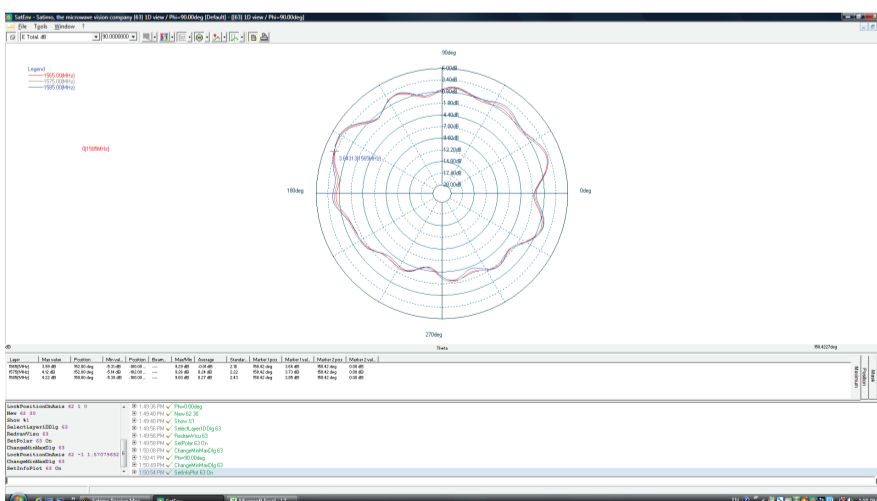

Y-Z Plane

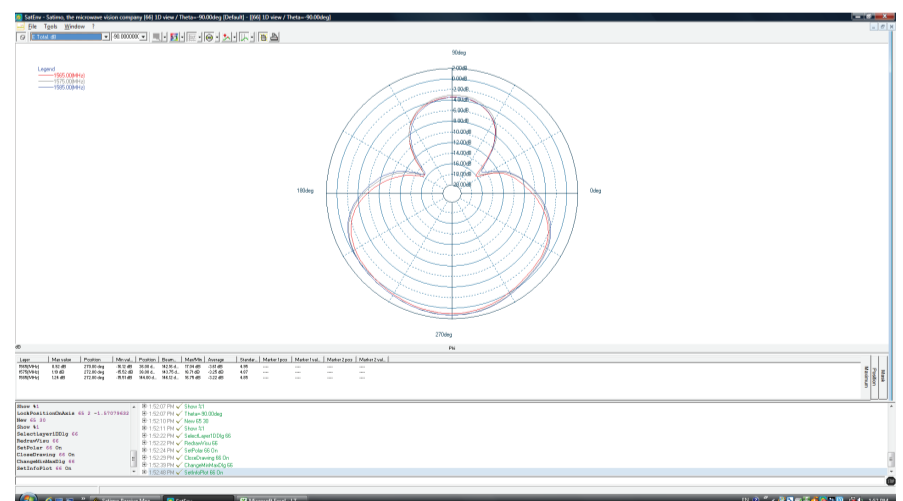

REVISED: 06.21.2018



5101 Hidden Creek Ln Spicewood TX 78669
Phone: 512-371-6159 | Fax: 512-351-8858
For terms and conditions of sales, please visit:
www.abracon.com

ABRACON IS
ISO9001-2015
CERTIFIED

1575MHz GPS Ceramic Chip Antenna

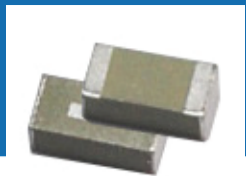

ACAG0301-1575-T

3.2 x 1.6 x 0.6mm



RoHS/RoHS II Compliant

MSL = 1

3D PATTERNS

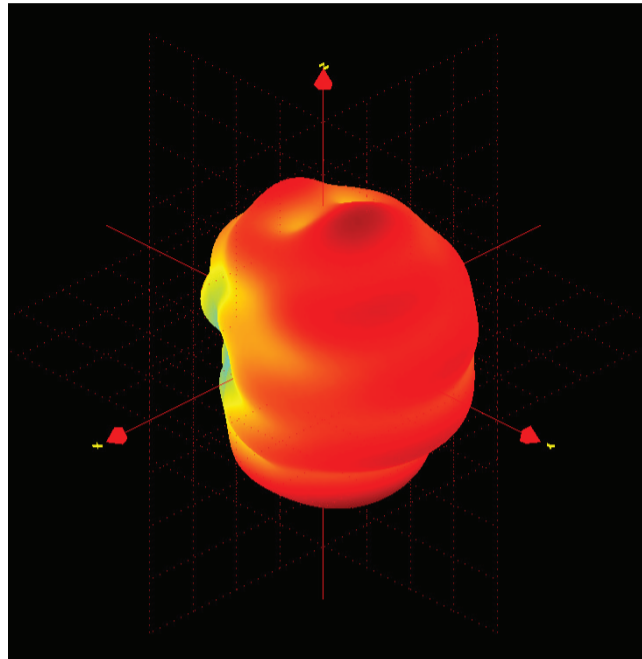

Frequency (MHz)	1565	1575	1585
Avg. Gain (dBi)	-1.26	-0.56	-1.58
Peak Gain (dBi)	3.96	4.18	4.05
Efficiency (%)	73	79	81

REFLOW SOLDERING STANDARD CONDITION

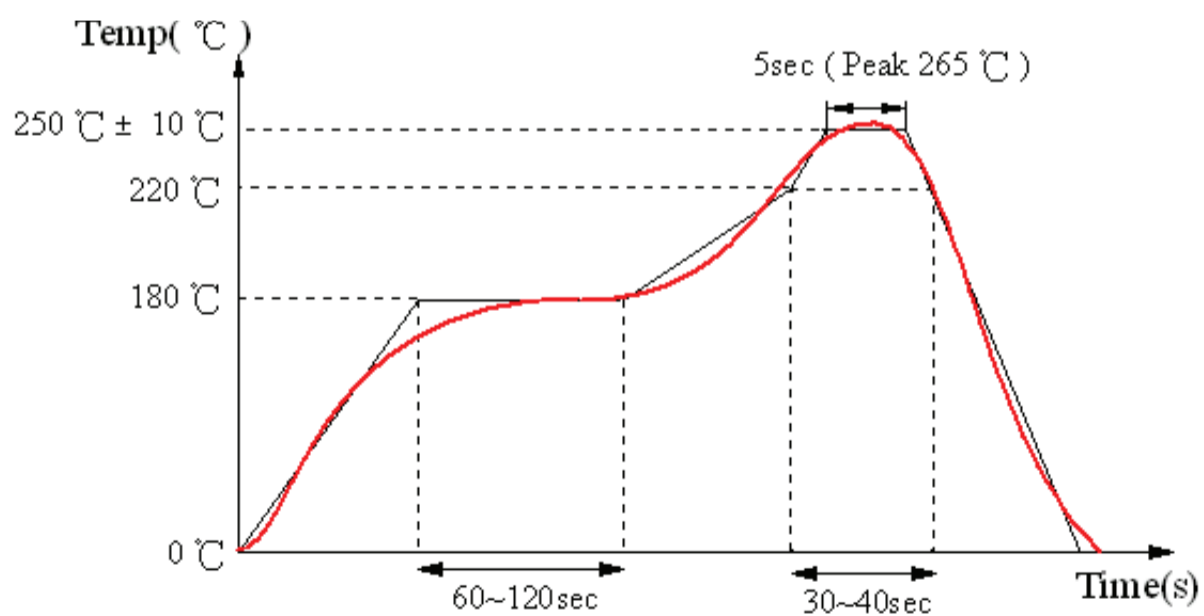

1575MHz GPS Ceramic Chip Antenna



ACAG0301-1575-T



3.2 x 1.6 x 0.6mm
RoHS/RoHS II Compliant
MSL = 1

PACKAGING

Reel (3000 pcs/Reel)

Size of the carton: 330 x 210 x 210 mm

Tape Dimensions: mm

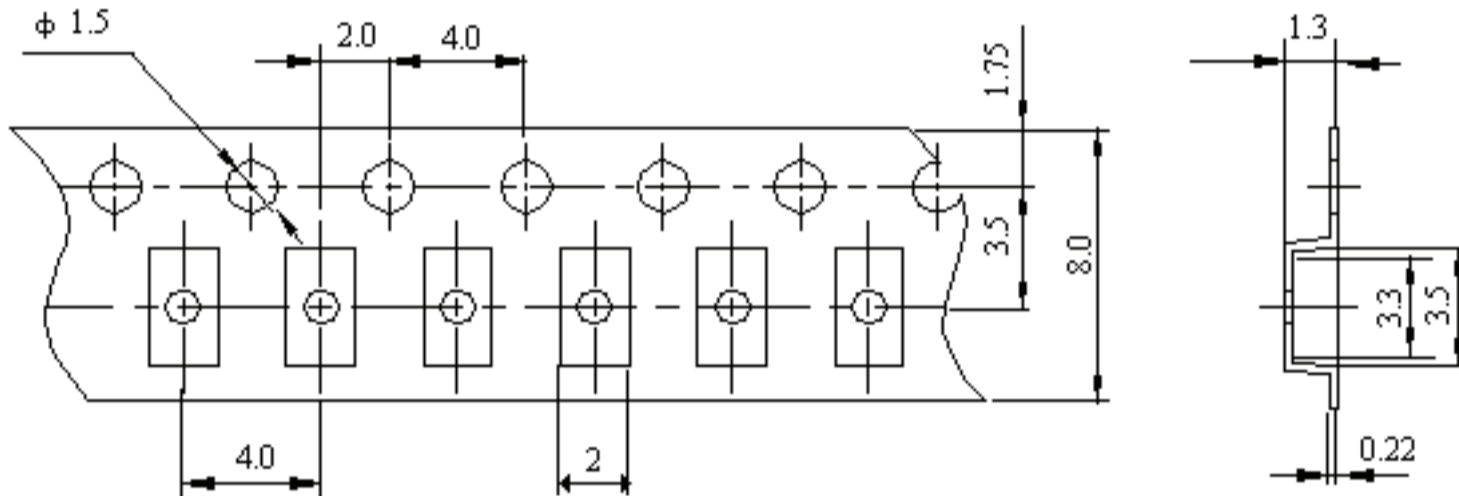

Reel Dimensions: mm

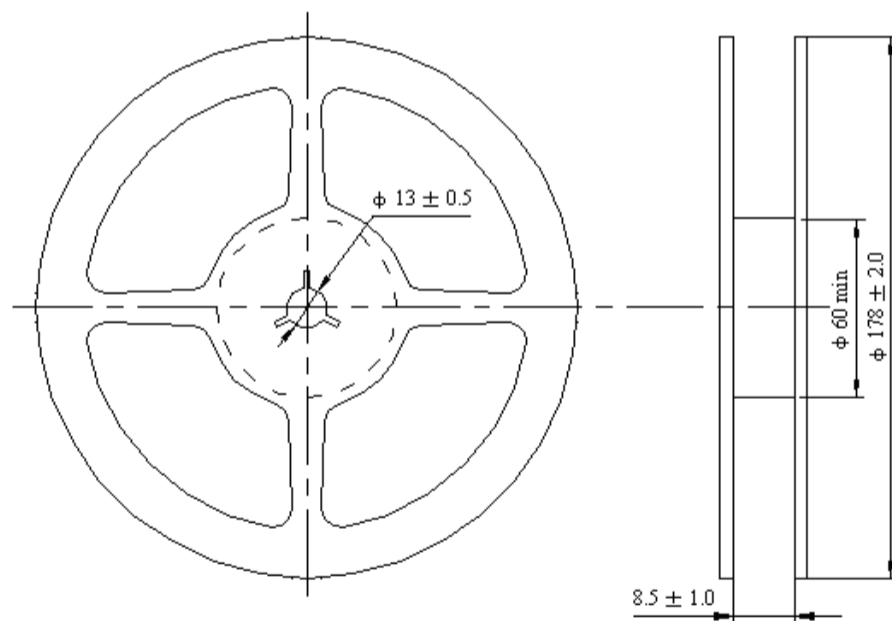

Storage Temperature Range : <30 degree C, Humidity : <60%RH

MSL-1

Oxidizable, 12 months in a vacuum sealed bag.

Once opened, please repack the unused items within 168 hours by re-seal package treatment.

1575MHz GPS Ceramic Chip Antenna

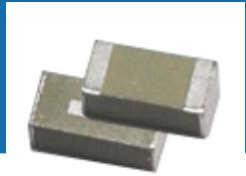

ACAG0301-1575-T



3.2 x 1.6 x 0.6mm
RoHS/RoHS II Compliant
MSL = 1

CAUTIONS

1. Static voltage

Static voltage between signal & ground may cause deterioration & destruction of the component. Please avoid static voltage.

2. Ultrasonic cleaning

Ultrasonic vibration may cause deterioration & destruction of the component. Please avoid ultrasonic cleaning.

3. Soldering

Only leads of the component may be soldered. Please avoid soldering to any other part of the component, such as on the patterns as this will change the performance of the antenna.