

General Description

The MAX11960 evaluation kit (EV kit) demonstrates the device's, 20-bit, 1.0MSPS, dual-channel, fully differential SAR ADC with internal reference buffers. The EV kit includes a graphical user interface (GUI) that provides communication from Avnet's ZedBoard™ development board for the Xilinx Zynq®-7000 SoC. The ZedBoard is not included with the EV kit and must be purchased through Avnet.

The ZedBoard communicates with the PC through an Ethernet cable using Windows® 7, or Windows 8/8.1-compatible software.

The EV kit comes with the MAX11960ETP+ installed.

Benefits and Features

- FMC Connector for Interface
- 75MHz SPI Clock Capability through FMC Connector
- Sync In and Sync Out for Coherent Sampling
- On-Board Input Buffers (MAX9632)
- On-Board +3.0V Reference Voltage (MAX6126)
- Windows 7, and Windows 8/8.1-Compatible Software

Ordering Information appears at end of data sheet.

System Block Diagram

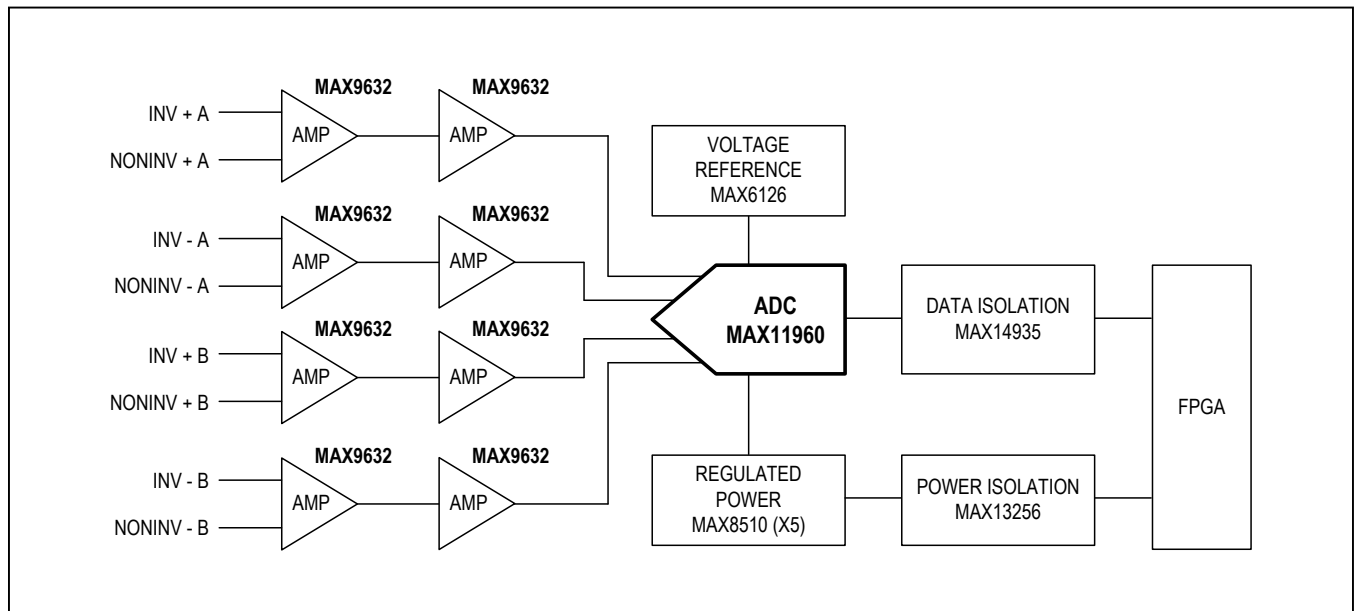

ZedBoard is a trademark of ZedBoard.org.

Zynq is a registered trademark of Xilinx, Inc.

Windows, Windows XP, and Windows Vista are registered trademarks and registered service marks of Microsoft Corporation.

Quick Start

Required Equipment

- MAX11960 differential EV kit with SD card
- ZedBoard development board
- Windows PC
- Ethernet cable
- +20V/1A DC power supply or equivalent wall plug
- Signal generator with differential outputs (e.g., Audio Precision 2700 series)
- Soldering iron and 2-pin 2.54mm header

Note: In the following sections, software-related items are identified by bolding. Text in **bold** refers to items directly from the EV kit software. Text in **bold and underlined** refers to items from the Windows operating system.

Procedure

The EV kit is fully assembled and tested. Follow the steps below to verify board operation:

- 1) Visit <http://www.maximintegrated.com/en/design/tools/applications/evkit-software/> to download the latest version of the EV kit software, 11960EVKit.ZIP. Save the EV kit software to a temporary folder and uncompress the ZIP file.
- 2) Solder the 2-pin header on J18-3V3 of the ZedBoard.
- 3) Connect the Ethernet cable from the PC to the ZedBoard and configure the **Internet Protocol Version 4 (TCP/IPv4)** properties in the local area connection to IP address **192.168.1.2** and subnet mask to **255.255.255.0**.
Note: If an ethernet port is not available on the PC, please use the option of ethernet to USB port adapter.
- 4) Verify that the ZedBoard's jumpers JP7, JP8, and JP11 have shunts installed at the GND position, and JP9 and JP10 at the 3V3 position.
- 5) Move the shunt of J18 of the ZedBoard to the 3V3 position from 1V8.
- 6) Insert the SD card with the boot image (BOOT.bin).
- 7) Verify that all jumpers on the EV kit are in their default positions, as shown in [Table 1](#).
- 8) Connect the ZedBoard to J2 on the EV kit for FMC connection.
- 9) Connect the +20V DC power supply between +20V and GNDA4 test points. If the power supply is unavailable, a +20V wall plug can be inserted into the J3 connector of the MAX11960 EV kit.
- 10) Insert the +12V wall plug into the connect J20 of the ZedBoard. Turn on the power to the ZedBoard.
- 11) Verify that the OLED screen on the ZedBoard displays "MAX11960".
- 12) Apply differential signals at test points INV+A and INV-A, and at INV+B and INV-B.
- 13) Enable the function generators.
- 14) Open the EV kit GUI, MAX11960EVKit.exe and verify that the status bar at the lower right corner displays **EV Kit Hardware Connected**.
- 15) Select **MAX11960** from the **Device** Dropdown list within the **System** tab sheet ([Figure 1](#)).
- 16) Click on the **Scope** ([Figure 2](#)) or **FFT** ([Figure 6](#)) tab sheet and start capturing data by clicking the **Capture** button.

Table 1. Jumper Descriptions

JUMPER	SHUNT POSITION	DESCRIPTION
JU1	1-2	Connects INV+A to GND for noninverting configuration on channel A of the MAX11960.
	3-4	Connects to the output of the op amp (U12).
	5-6*	Connects NONINV+A to GND for inverting configuration on channel A of the MAX11960.
JU2	1-2	Connects output of the op amp (U10) to the negative input of the op amp (U8).
	3-4	GND the negative input of the op amp (U8).
	5-6*	Connects output of the op amp (U10) to positive input of the op amp (U8).
	7-8	GND the positive input of the op amp (U8).
	9-10	Connects REFA2 to positive input of the op amp (U8).
JU3	1-2*	Connects output of the op amp (U8) to AIN+A.
	3-4	Connects output of the op amp (U13) to AIN+A.
	5-6*	Connects output of the op amp (U7) to AIN-A.
	7-8	Connects output of the op amp (U14) to AIN-A.
	9-10*	Connects output of the op amp (U13) to AIN+B.
	11-12	Connects output of the op amp (U8) to AIN+B.
	13-14*	Connects output of the op amp (U14) to AIN-B.
	15-16	Connects output of the op amp (U7) to AIN-B.
JU4	1-2	Connects to REF offset.
	3-4*	Connects to REF/2 offset.
	5-6	Connects to GND.

JUMPER	SHUNT POSITION	DESCRIPTION
JU5	1-2	Connects NONINV-A to GND for inverting configuration on channel A of the MAX11960.
	3-4	Connects to the output of the op amp (U10).
	5-6*	Connects INV-A to GND for noninverting configuration on channel A of the MAX11960.
JU6	1-2	Connects REFA2 to positive input of the op amp (U7).
	3-4	GND the positive input of the op amp (U7).
	5-6*	Connects output of the op amp (U12) to positive input of the op amp (U7).
	7-8	GND the negative input of the op amp (U7).
	9-10	Connects output of the op amp (U12) to the negative input of the op amp (U7).
JU8	1-2	Connects INV+B to GND for noninverting configuration on channel B of the MAX11960.
	3-4	Connects to the output of the op amp (U16).
	5-6*	Connects NONINV+B to GND for inverting configuration on channel B of the MAX11960.
JU9	1-2	Connects output of the op amp (U15) to the negative input of the op amp (U3).
	3-4	GND the negative input of the op amp (U3).
	5-6*	Connects output of the op amp (U15) to positive input of the op amp (U13).
	7-8	GND the positive input of the op amp (U13).
	9-10	Connects REFB2 to positive input of the op amp (U13).

Table 1. Jumper Descriptions (continued)

JUMPER	SHUNT POSITION	DESCRIPTION
JU11	1-2	Connects to REF offset.
	3-4*	Connects to REF/2 offset.
	5-6	Connects to GND.
JU12	1-2	Connects NONINV-B to GND for inverting configuration on channel B of the MAX11960.
	3-4	Connects to the output of the op amp (U15).
	5-6*	Connects INV-B to GND for noninverting configuration on channel B of the MAX11960.
JU13	1-2	Connects REFB2 to positive input of the op amp (U14).
	3-4	GND the positive input of the op amp (U14).
	5-6*	Connects output of the op amp (U16) to positive input of the op amp (U14).
	7-8	GND the negative input of the op amp (U14).
	9-10	Connects output of the op amp (U16) to the negative input of the op amp (U14).
JU16	1-2*	REFINAB connects to on-board +3.0V reference.
	2-3	User-supplied REFINAB. Apply reference voltage at the EXT_REFINAB test point.
JU17	1-2*	Set isolator's voltage level to OVDDA
	2-3	Set isolator's voltage level to OVDDB
JU18	1-2, 4-5, 7-8, 16-17, 19-20, 22-23, 25-26*	Connects the SPI signals coming from the FMC connectors to the MAX11960.
	Not installed	User-supplied SPI. Connect SPI signals at SCLK, CNVSTA, CNVSTB, DINA, DINB, DOUA, and DOUTB test points.

JUMPER	SHUNT POSITION	DESCRIPTION
JU20	Not installed*	Enables line driver.
	Installed	Disables line driver.
JU22	1-2, 3-4*	DVDDA and DVDDB supplies connects to on-board +1.8V LDO.
	Not installed	User-supplied DVDDA and DVDDB. Apply +1.8V at the DVDDA and DVDDB test points.
JU23	1-3, 2-4*	OVDDA and OVDDB supplies connects to on-board +1.8V LDO.
	3-5, 4-6	OVDDA and OVDDB supplies connects to on-board +3.3V LDO.
	Not installed	User-supplied OVDDA and OVDDB. Apply +1.8V to +3.3V at the OVDDA and OVDDB test points.
JU24	1-2, 3-4*	AVDDA and AVDDB supplies connects to on-board +1.8V LDO.
	Not installed	User-supplied AVDDA and AVDDB. Apply +1.8V at the AVDDA and AVDDB test points.
JU25	1-2, 3-4*	REFVDDA and REFVDDB supplies connects to on-board +3.3V LDO.
	Not installed	User-supplied REFVDDA and REFVDDB. Apply +3.3V at the REFVDDA and REFVDDB test points.
JU30	Install	Do not use.
	Not installed*	User-supplied +20V power-supply header connection.
JU31	1-2*	Enabled MAX13256 (U2)
	2-3	Disable MAX13256 (U2)

Table 1. Jumper Descriptions (continued)

JUMPER	SHUNT POSITION	DESCRIPTION
JU32	1-2	User-supplied +24V power-supply connection.
	3-4*	Isolated +24V from MAX13256
JU33	1-2	User-supplied -24V power-supply connection.
	3-4*	Isolated -24V from MAX13256
JU34	1-2, 7-8	User-supplied +15V supply to analog front-end op amps.
	3-4, 5-6*	Isolated +15V supply to analog front-end op amps and LDO.

JUMPER	SHUNT POSITION	DESCRIPTION
JU35	1-2	GND the negative supply of the analog front-end op amps.
	3-4	User-supplied -15V supply to analog front-end op amps.
	5-6*	Isolated -15V supply to analog front-end op amps.
JU36	1-2	User-Supplied +5V to LDOs that powers the supplies on the MAX11960.
	3-4*	+5V supply to LDOs that powers the supplies on the MAX11960.

*Default position.

General Description of Software

The main window of the MAX11960 EV kit software contains six tabs: **System**, **Scope**, **DMM**, **Histogram**, **FFT**, and **Register Settings**.

System Tab

The System tab is an overview of the evaluation system. The left side displays Sampling Rate, Number of Samples, Clock Source, and Sync-Out CLK for the coherent sampling feature. For the Clock Source selection, the ZedBoard internal clock is always a valid option. If the External Sync-In is selected, then an external clock must be applied at the DCLK_IN SMA on the EV kit. The Sync-Out CLK selection is used to synchronize the signal generator with a 10MHz input. See the [Sync Input and Sync Output](#) section for more information.

The center of the tab sheet displays a block diagram and the description of the installed ADC: Device, Resolution, Input Range, Reference Voltage, and Max Sampling Rate. The Device dropdown list provides the selection between Maxim’s 16-, 18-, and 20-bit parts. Once appro-

riately selected, the description of the ADC will change accordingly. The Reference Voltage dropdown list is adjustable. Please see the MAX11960 data sheet for detailed specification of the reference voltage range.

The right-side of the tab sheet reads a single conversion in LSB and decimal. An additional feature is the ADC calibration.

Scope Tab

The **Scope** tab sheet is used to capture data and display it in the time domain. Sampling rate and number of samples can also be set in this tab if they were not adjusted appropriately in other tabs. The **Display Unit** drop-down list allows counts and voltages. Below the graph, the user can select to display **Channel A** and/or **Channel B**. Once the desired configuration is set, click on the **Capture** button. The right-side of the tab sheet displays details of the waveform, such as **Average**, **Standard Deviation**, **Maximum**, **Minimum**, and **Fundamental Frequency**.

[Figure 2](#) displays data of both ADCs when differential sinusoidal are applied at the inputs on the EV kit.

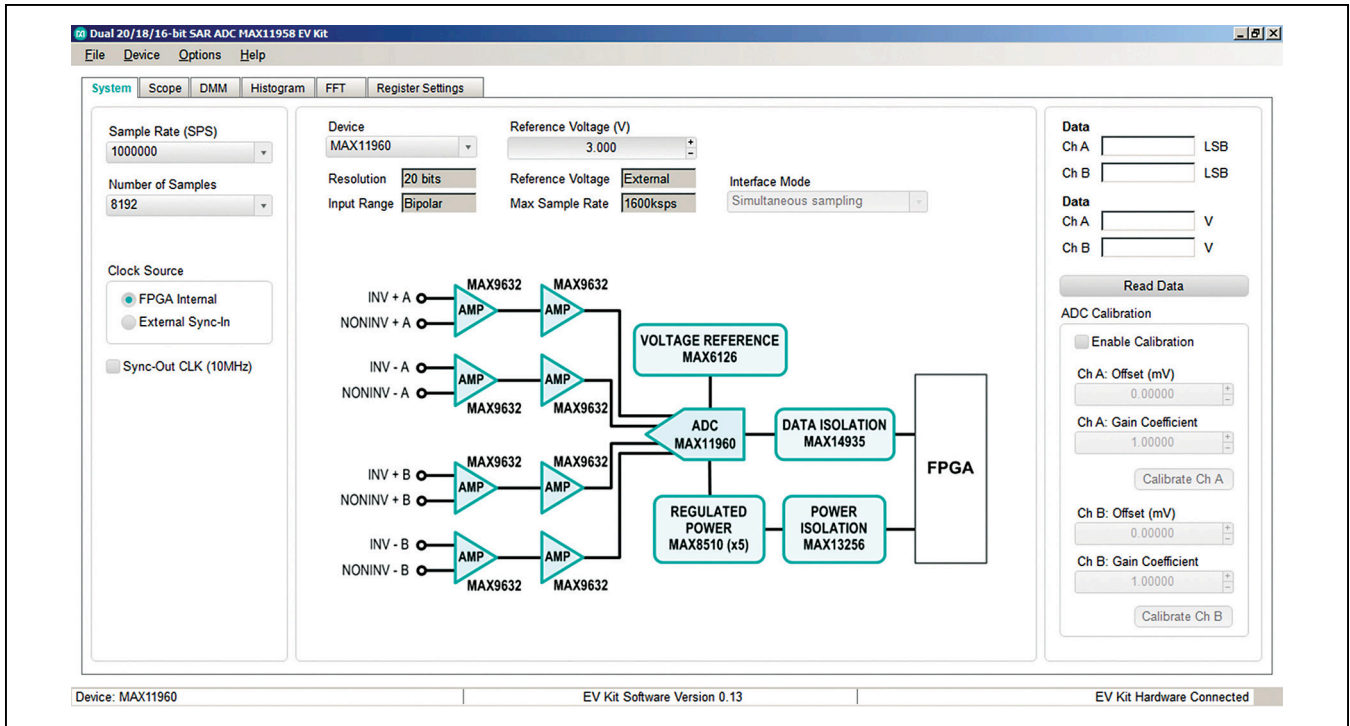

Figure 1. MAX11960 EV Kit Main Window (System Tab)

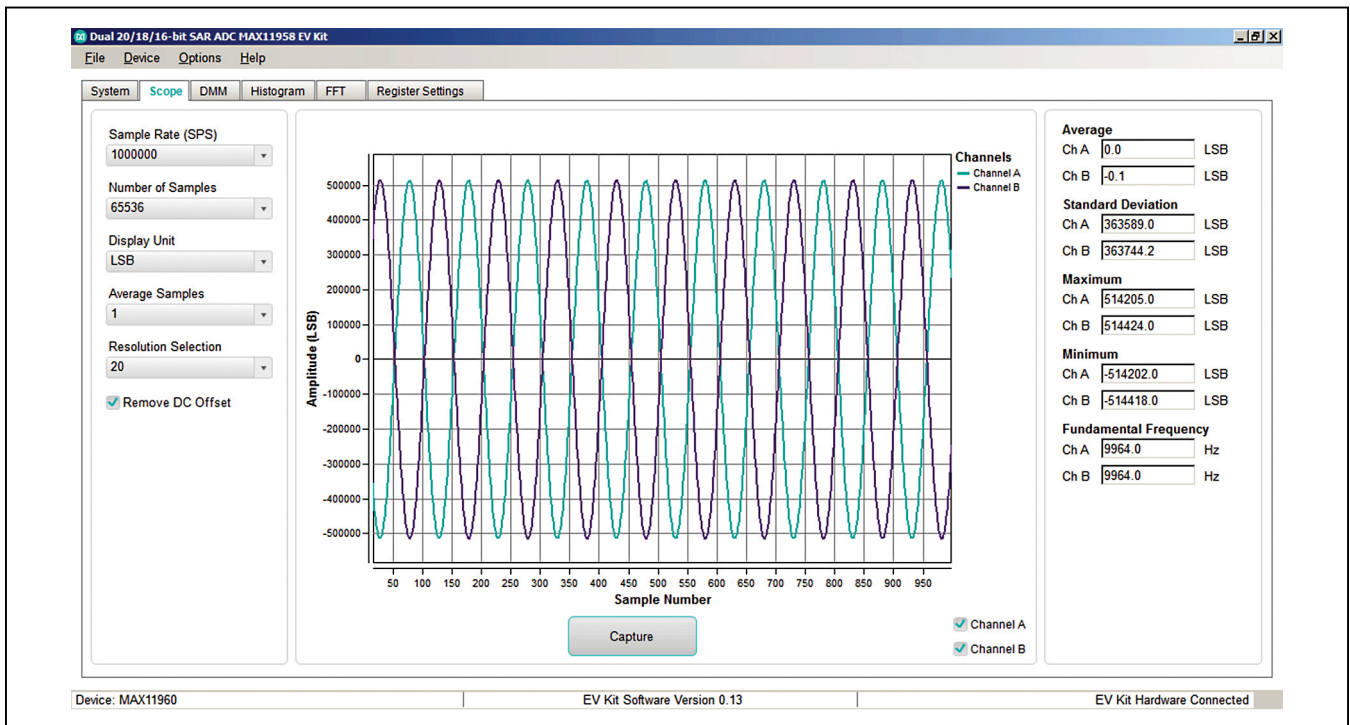

Figure 2. MAX11960 EV Kit Main Window (Scope Tab)

DMM Tab

The DMM tab sheet provides the typical information as a digital multimeter. Once the desired configuration is set, click on the **Capture** button.

Figure 3 displays the numerical value when the inputs on the EV kit are shorted to ground using the jumpers. See Table 1 for shunt settings.

Histogram Tab

The **Histogram** tab sheet is used to capture the histogram of the data. Sampling rate and number of samples can also be set in this tab if they were not adjusted appropriately in other tabs. Make sure that the number of samples do not exceed 524288. Otherwise, data capturing is longer than expected. Below the graph, the user can select to display **Channel A** and/or **Channel B**. Once the desired configuration is set, click on the **Capture** button. The right side of the tab sheet displays details of the histogram such as **Average**, **Standard Deviation**, **Maximum**, **Minimum**, **Peak to Peak Noise**, **Effective Resolution**, and **Noise Free Resolution**.

To use this histogram feature, apply a DC voltage at the input of channel A and/or B. Figure 4 displays the results when the input of the EV kit are shorted to ground. See Table 1 for placement of shunt positions.

FFT Tab

The **FFT** tab is used to display the FFT of the data. Sampling rate and number of samples can also be set in this tab if they were not adjusted appropriately in other tabs. When coherent sampling is needed, this tab sheet allows the user to calculate the input frequency or the master clock coming into the board. Either adjust the input frequency applied to the signal generator or adjust the master clock applied to the DCLK_IN SMA connector. See the *Sync Input and Sync Output* section before using this feature. Once the desired configuration is set, click on the **Capture** button. The right side of the tab sheet displays the performance based on the FFT, such as **Fundamental Frequency**, **THD**, **SNR**, **SINAD**, **SFDR**, **ENOB**, and **Noise Floor**.

Figure 5 is the setup Maxim Integrated uses to capture data for coherent sampling.

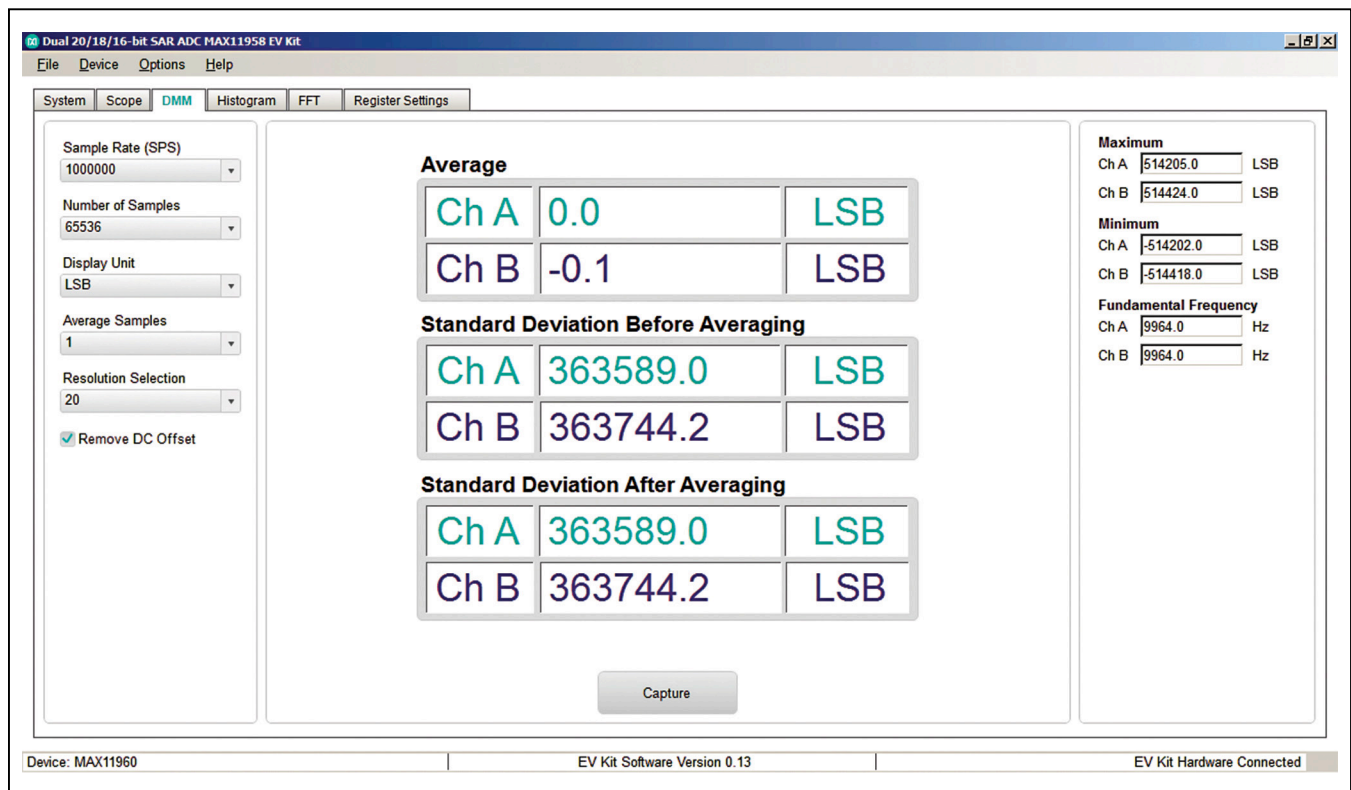

Figure 3. MAX11960 EV Kit Main Window (DMM Tab)

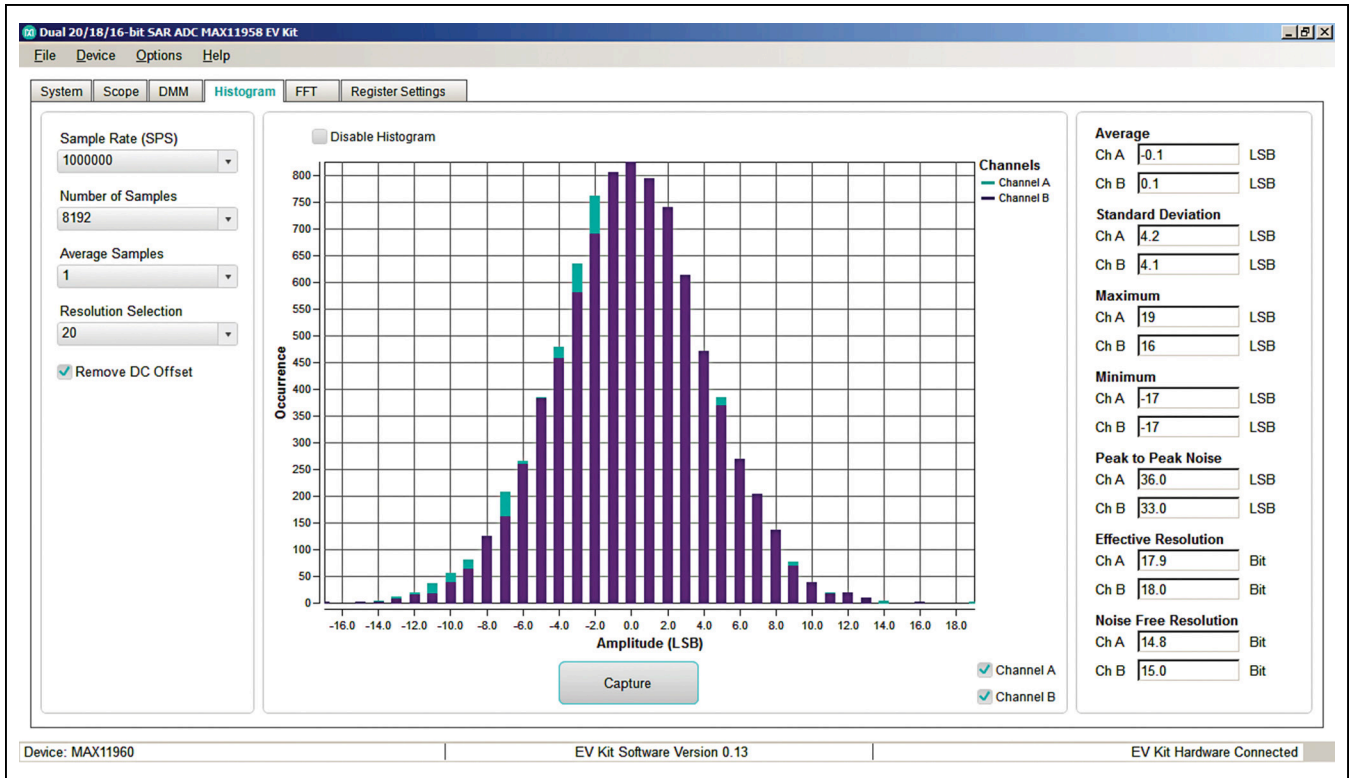

Figure 4. MAX11960 EV Kit Main Window (Histogram Tab)

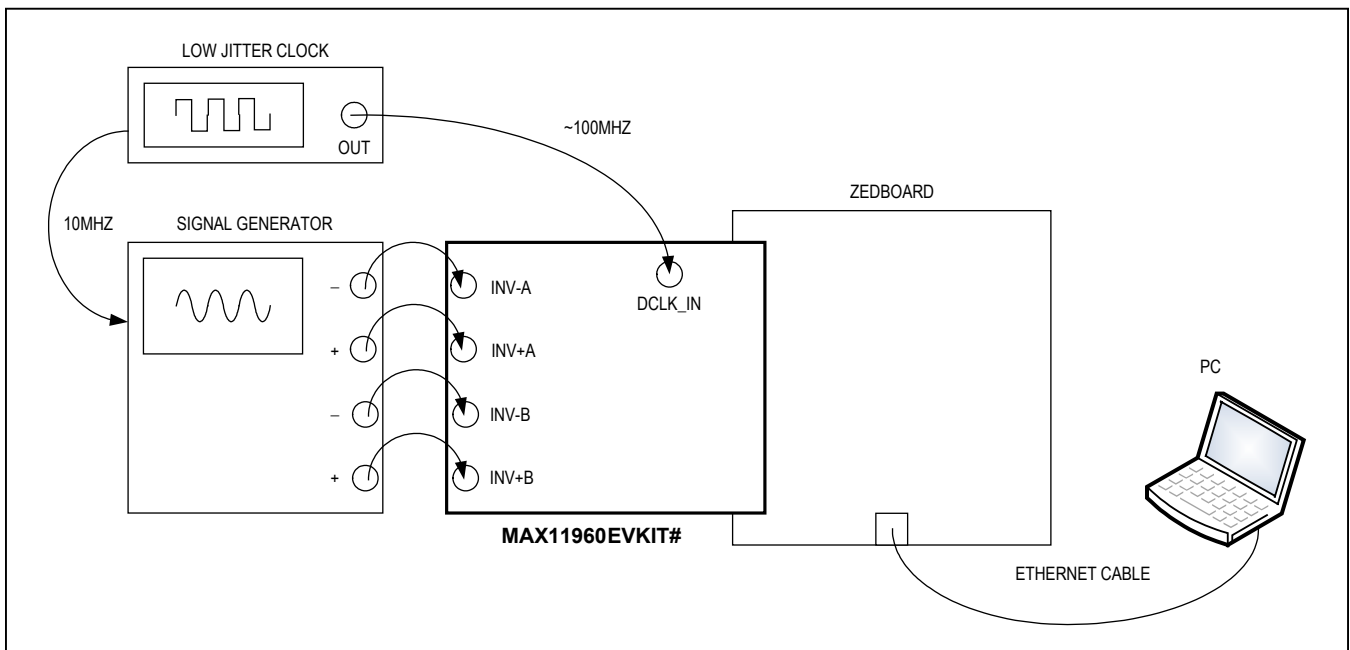

Figure 5. MAX11960 Differential EV Kit Coherent Sampling Setup

The input signal from the signal generator must be exactly **10000.000000Hz**. The low-jitter clock is synchronized with the signal generator. The master clock was initially set to **100000000 Hz** but to achieve coherent sampling, then user must click on the **Calculate** button and use the **Adjusted(Hz)** frequency. **99523158.694 Hz** was entered into our low-jitter clock. The master clock is fed back to the ZedBoard and multiplied by 3/2, then generates a system clock that drives the Xilinx FPGA. All SPI timing and sampling rate are based off the system clock.

If the results do not look similar to [Figure 6](#) and more similar to [Figure 7](#), then check all connections in [Figure 5](#) to make sure the setup is synchronizing properly.

Register Settings Tab

The **Register Settings** tab allows the user to read and write to the appropriate registers at a bit level. Each bit(s) in each register contains the **Value**, **Setting**, and **Description**.

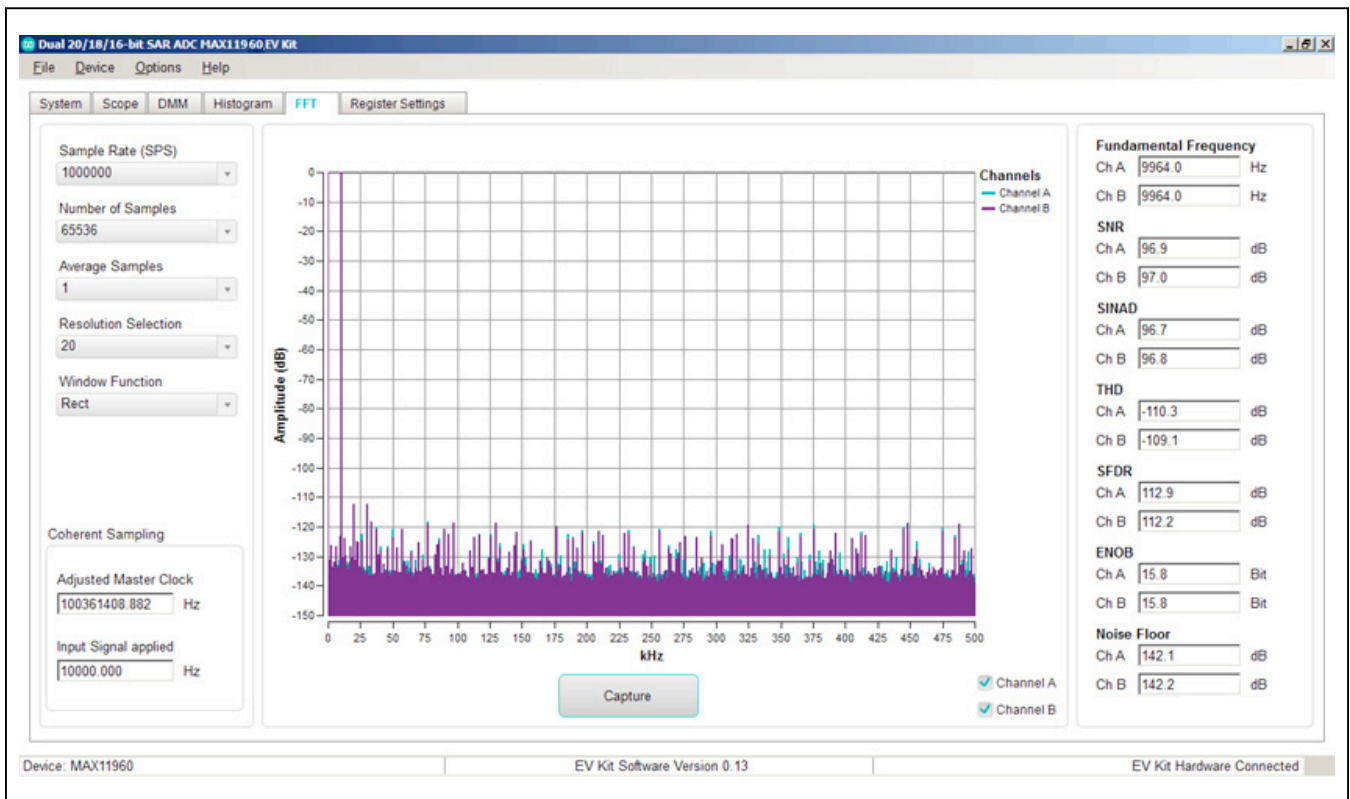

Figure 6. MAX11960 EV Kit Main Window, Coherent Sampling Results (FFT Tab)

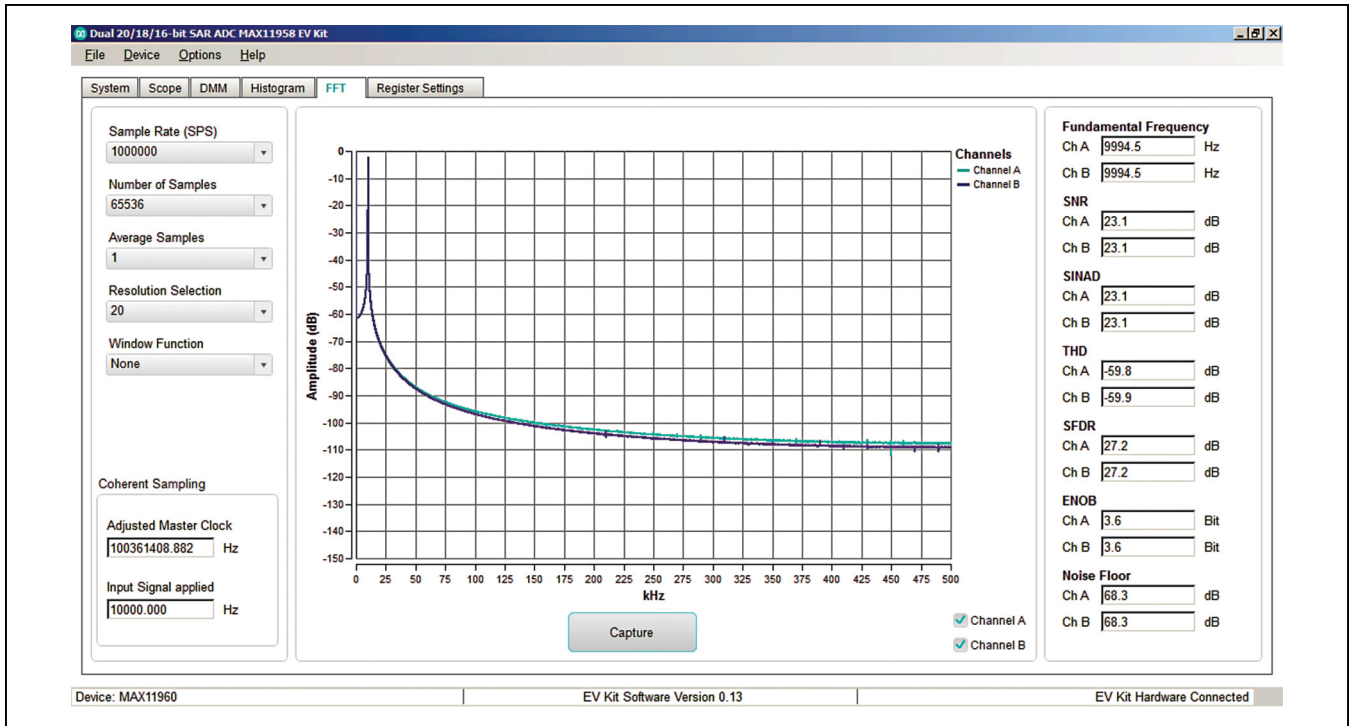

Figure 7. MAX11960 EV Kit Main Window, Non-coherent Sampling Results (FFT Tab)

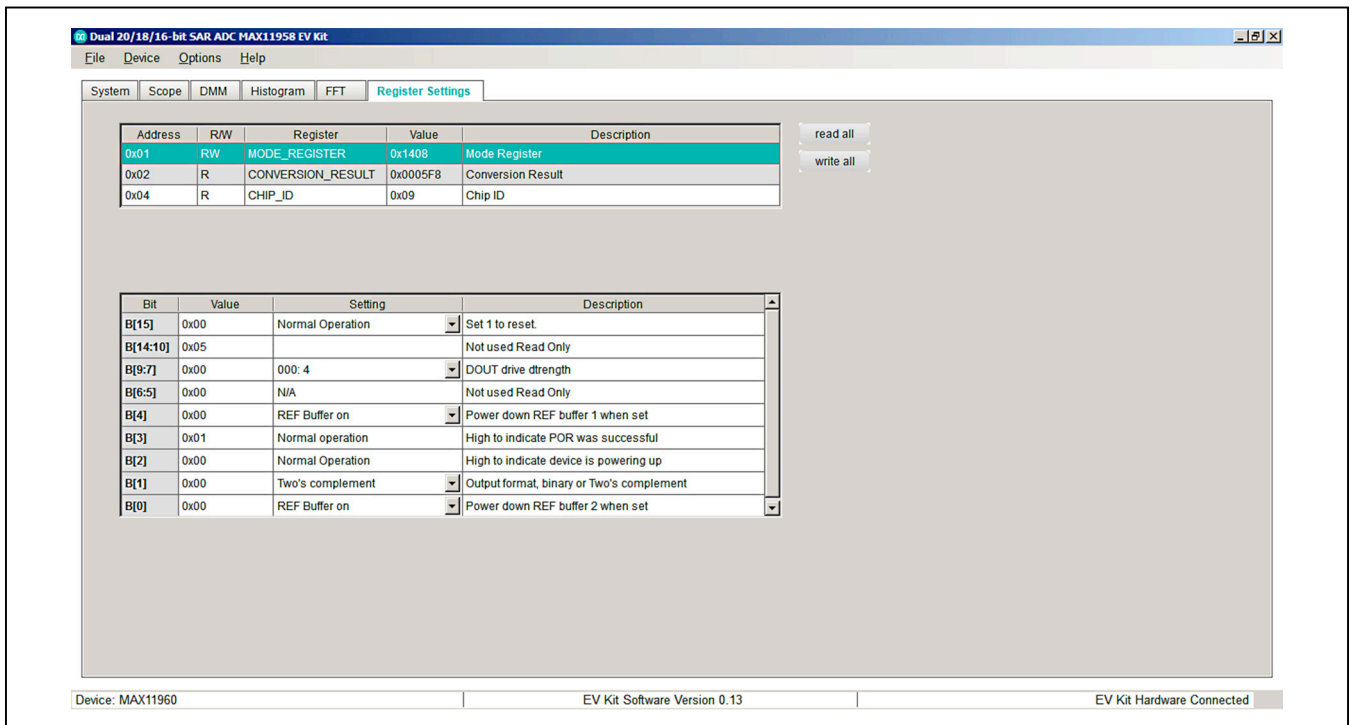

Figure 8. MAX11960 EV Kit Main Window, Register Settings (FFT Tab)

General Description of Hardware

This EV kit provides a proven layout to demonstrate the performance of the MAX11960 18-bit, dual-channel SAR ADC. Included in the EV kit are digital isolators (MAX14935), ultra low-noise LDOs (MAX8510) to all MAX11960 supply pins, on-board reference (MAX6126), precision amplifiers (MAX9632) for the analog inputs, and sync in and sync out signals for coherent sampling.

User-Supplied SPI

To evaluate the EV kit with a user-supplied SPI bus, remove shunts from jumper JU18. Apply the user-supplied SPI signals to the SCLK, CNVSTA, CNVSTB, DINA, DINB, DOUTA, and DOUTB test points. Make sure the return ground is the same as the MAX11960's ground.

User-Supplied REFVDD

The REFVDD supply is powered through a +3.3V LDO by default. For user-supplied REFVDD, remove the shunt of the jumper JU25 and apply +2.7V to +3.6V at the REFVDDA and REFVDDB test points.

User-Supplied AVDD

The AVDD supply is powered through a +1.8V LDO by default. For user-supplied AVDD, remove the shunt of the jumper JU24 and apply +1.7V to +1.9V at the AVDDA and AVDDB test points.

User-Supplied DVDD

The DVDD supply is powered through a +1.8V LDO by default. For user-supplied DVDD, remove the shunt of the jumper JU22 and apply +1.7V to +1.9V at the DVDDA and DVDDB test points.

User-Supplied OVDD

The OVDD supply is powered through a +1.8V LDO by default. Move the shunt to the 2-3 position of jumper JU23 to use the +3.3V LDO. For user-supplied OVDD, remove the shunt of the jumper JU23 and apply +1.5V to +3.6V at the OVDDA and OVDDB test points.

User-Supplied REFINAB

The MAX11960 uses an on-board +3V reference MAX6126 by default. For user-supplied REFINAB, move the shunt of jumper JU16 to the 2-3 position. Make sure that REFINAB is 300mV below REFVDD before applying the reference.

Analog Inputs

For simplicity, channel A will be discussed but will apply to channel B as well. Both analog inputs, AIN+A and AIN-A, range from 0V to V_{REF}. The differential input range is from -V_{REF} to +V_{REF} and the full-scale range is 2 times the V_{REF}. The desired input signals are applied at the INV+ and INV- SMAs for inverting configuration, and NONINV+A and NONINV-A SMAs for noninverting configuration.

Sync Input and Sync Output

The DCLK_IN SMA accepts an approximate 100MHz waveform signal to generate the system clock of the ZedBoard. For maximum performance, use a low-jitter clock that syncs to the user's analog function generator. The SYNC_OUT SMA outputs a 10MHz square waveform that syncs to the user's analog function generator. Both options are used for coherent sampling of the IC. Only one option should be used at a time. The relationship between f_{IN}, f_S, N_{CYCLES}, and M_{SAMPLES} is given as follows:

$$\frac{f_{IN}}{f_S} = \frac{N_{CYCLES}}{M_{SAMPLES}}$$

where,

f_{IN} = Input frequency

f_S = Sampling frequency

N_{CYCLES} = Prime number of cycles in the sampled set

M_{SAMPLES} = Total number of samples

Table 2. Analog Input Configurations

JUMPER	INVERTING	NONINVERTING
JU1	5-6	1-2
JU2	5-6	5-6
JU4	3-4	3-4
JU5	1-2	5-6
JU6	5-6	5-6
JU8	5-6	1-2
JU9	5-6	5-6
JU11	3-4	3-4
JU12	1-2	5-6
JU13	5-6	5-6

Component Information, PCB Layout, and Schematics

See the following links for component information, PCB layout diagrams and schematics.

- [MAX11960 EV BOM](#)
- [MAX11960 EV PCB Layout](#)
- [MAX11960 EV Schematics](#)

Ordering Information

PART	TYPE
MAX11960EVKIT#	EVKIT

#Denotes RoHS compliant.

Revision History

REVISION NUMBER	REVISION DATE	DESCRIPTION	PAGES CHANGED
0	3/16	Initial release	—

For pricing, delivery, and ordering information, please contact Maxim Direct at 1-888-629-4642, or visit Maxim Integrated's website at www.maximintegrated.com.

Maxim Integrated cannot assume responsibility for use of any circuitry other than circuitry entirely embodied in a Maxim Integrated product. No circuit patent licenses are implied. Maxim Integrated reserves the right to change the circuitry and specifications without notice at any time.

TITLE: Bill of Materials

DATE: 05/13/2015

DESIGN: max119xx_evkit_a

ITEM	QTY	REF DES	MFG PART #	MANUFACTURE R	VALUE	DESCRIPTION
1	6	+20V, +3.3V_A, EXT_+5V, U23_VCC, EXT_+15V, EXT_+24V	5005	KEystone	N/A	TESTPOINT WITH 1.80MM HOLE DIA, RED, COMPACT; NOT FOR COLD TEST
2	7	AVDDA, AVDDDB, OVDDA, OVDDDB, CNVSTA, CNVSTB, EXT_REFINB	PEC01SAAN	SULLINS ELECTRONICS CORP	PEC01SAAN	CONNECTOR; MALE; THROUGH HOLE; BREAKAWAY; STRAIGHT; 1PIN
3	36	C1, C2, C45, C48, C51, C54, C61, C64, C67, C70, C74, C77, C80, C83, C90, C93, C96, C99, C115, C117, C119, C121, C124, C127, C130, C133, C138, C139, C151, C155, C156, C160, C165, C177, C179, C188	C2012X5R1V106K085	TDK	10UF	CAPACITOR; SMT (0805); CERAMIC CHIP; 10UF; 35V; TOL=10%; TG=-55 DEGC TO +85 DEGC; TC=X5R
4	45	C3, C4, C8, C9, C46, C47, C52, C53, C62, C63, C68, C69, C75, C76, C81, C82, C91, C92, C97, C98, C101- C104, C107, C110-C112, C116, C118, C120, C122, C125, C128, C131, C134, C136, C137, C152, C154, C157, C159, C171, C173, C187	GRM188R72A104KA35	MURATA	0.1UF	CAPACITOR; SMT (0603); CERAMIC CHIP; 0.1UF; 100V; TOL=10%; TG=-55 DEGC TO +125 DEGC; TC=X7R
5	6	C5, C7, C105, C106, C108, C109	UMK107BJ105KA-T; C1608X5R1H105K080AB	TAIYO YUDEN/TKD	1UF	CAPACITOR; SMT (0603); CERAMIC CHIP; 1UF; 50V; TOL=10%; MODEL=_MK SERIES; TG=-55 DEGC TO +85 DEGC
6	7	C10, C59, C86, C113, C114, C153, C158	GRM32ER72A225KA35; CGA6N3X7R2A225K230	MURATA/TKD	2.2UF	CAPACITOR; SMT (1210); CERAMIC CHIP; 2.2UF; 100V; TOL=10%; MODEL=GRM SERIES; TG=-55 DEGC to +125 DEGC; TC=X7R
7	1	C11	C1608X5R1V225K080AC; GRM188R6YA225KA12	TKD/MURATA	2.2UF	CAPACITOR; SMT (0805); CERAMIC CHIP; 2.2UF; 50V; TOL=10%; TG=-55 DEGC TO +125 DEGC; TC=X7R
8	13	C12, C14, C16, C18, C20, C28, C29, C31, C33, C35, C37, C39, C42	CGA2B3X7R1H104K; C1005X7R1H104K050BB; GRM155R71H104KE14	TKD; MURATA	0.1UF	CAPACITOR; SMT (0402); CERAMIC CHIP; 0.1UF; 50V; TOL=10%; TG=-55 DEGC TO +125 DEGC; TC=X7R
9	12	C13, C15, C17, C19, C27, C30, C32, C34, C36, C38, C40, C41	C2012X5R1V106K085	TKD	10UF	CAPACITOR; SMT (0805); CERAMIC CHIP; 10UF; 35V; TOL=10%; TG=-55 DEGC TO +85 DEGC; TC=X5R

10	4	C23, C26	CGA4F3C0G2E102J	TDK	1000PF	CAPACITOR; SMT (0805); CERAMIC CHIP; 1000PF; 250V; TOL=5%; MODEL=; TG=-55 DEGC TO +125 DEGC; TC=C0G
11	8	C43, C49, C60, C66, C78, C95, C163, C164	C0603C102K1GAC	KEMET	1000PF	CAPACITOR; SMT (0603); CERAMIC CHIP; 1000PF; 100V; TOL=10%; MODEL=C0G; TG=-55 DEGC TO +125 DEGC; TC=
12	10	C44, C50, C56, C65, C71, C73, C79, C85, C94, C100	CGA4F3C0G2E102J	TDK	1000PF	CAPACITOR; SMT (0805); CERAMIC CHIP; 1000PF; 250V; TOL=5%; MODEL=; TG=-55 DEGC TO +125 DEGC; TC=C0G
13	2	C55, C84	CGA5L4C0G2J332J; CL31C332JHNFN	TDK/SAMSUNG ELECTRONICS	3300PF	CAPACITOR; SMT (1206); CERAMIC CHIP; 3300PF; 630V; TOL=5%; MODEL=; TG=-55 DEGC TO +125 DEGC; TC=C0G
14	9	C123, C126, C129, C132, C135, C175, C176, C178, C189	C0603C103K2RAC	KEMET	0.01UF	CAPACITOR; SMT (0603); CERAMIC CHIP; 0.01UF; 200V; TOL=10%; MODEL=; TG=-55 DEGC TO +125 DEGC; TC=X7R
15	1	C166	GRM188R71E474KA12	MURATA	0.47UF	CAPACITOR; SMT (0603); CERAMIC CHIP; 0.47UF; 25V; TOL=10%; MODEL=GRM SERIES; TG=-55 DEGC TO +125 DEGC; TC=X7R
16	4	C167-C170	C2012X7R1E475K125AB	TDK	4.7UF	CAPACITOR; SMT (0805); CERAMIC CHIP; 4.7UF; 25V; TOL=10%; MODEL=; TG=-55 DEGC TO +125 DEGC; TC=X7R
17	3	C172, C174, C186	08053C105JAT2A	AVX	1UF	CAPACITOR; SMT (0805); CERAMIC CHIP; 1UF; 25V; TOL=5%; MODEL=X7R; TG=-55 DEGC TO +85 DEGC; TC=+/-
18	1	D1	MBR0520L	FAIRCHILD SEMICONDUCTOR	MBR0520L	DIODE, SCHOTTKY, SOD-123, PIV=20V, Vf=0.385V@If=0.5A, If(ave)=0.5A
19	1	D2	LGL29K-G2J1-24-Z	OSRAM	LGL29K-G2J1-24-Z	DIODE; LED; SMARTLED; GREEN; SMT; PIV=1.7V; IF=0.02A
20	1	D3	LS L29K-G1J2-1-Z	OSRAM	LS L29K-G1J2-1-Z	DIODE; LED; SMART; RED; SMT (0603); PIV=1.8V; IF=0.02A; -40 DEGC TO +100 DEGC
21	2	D4, D5	BAS4002A-RPP	INFINEON	BAS4002A-RPP	DIODE; SCH; LOW VF SCHOTTKY DIODE ARRAY; SMT (SOT-143); PIV=40V; IF=0.2A
22	10	INV+A, INV+B, INV-A, INV-B, DCLK_IN, NONINV+A, NONINV+B, NONINV-A, NONINV-B, SYNC_OUT	5-1814832-1	TYCO	5-1814832-1	CONNECTOR; FEMALE; THROUGH HOLE; CONN SOCKET SMA STR DIE CAST PCB; STRAIGHT; 5PINS
23	2	EXT_-15V, EXT_-24V	5008	KEYSTONE	N/A	TEST POINT; PIN DIA=0.125IN; TOTAL LENGTH=0.35IN; BOARD HOLE=0.063IN; ORANGE; PHOSPHOR BRONZE WIRE SILVER PLATE FINISH; RECOMMENDED FOR BOARD THICKNESS=0.062IN; NOT FOR COLD TEST

24	13	TP8, GND1-GND6, TP27, TP28, TP36, GNDD1-GNDD3	5006	KEYSTONE	N/A	TEST POINT; PIN DIA=0.125IN; TOTAL LENGTH=0.35IN; BOARD HOLE=0.063IN; BLACK; PHOSPHOR BRONZE WIRE SILVER PLATE FINISH; RECOMMENDED FOR BOARD THICKNESS=0.062IN; NOT FOR COLD TEST
25	1	GNDD	5123	KEYSTONE	N/A	TEST POINT; PIN DIA=0.125IN; TOTAL LENGTH=0.35IN; BOARD HOLE=0.063IN; GRAY; PHOSPHOR BRONZE WIRE SILVER PLATE FINISH; RECOMMENDED FOR BOARD THICKNESS=0.062IN; NOT FOR COLD TEST
26	1	J1	TSW-106-08-S-D-RA	SAMTEC	TSW-106-08- S-D-RA	CONNECTOR; THROUGH HOLE; DOUBLE ROW; RIGHT ANGLE; 12PINS; THIS PART IS DEDICATED FOR PMOD PERIPHERAL BOARD
27	1	J2	ASP-134604-01	SAMTEC	ASP-134604- 01	CONNECTOR; MALE; SMT; HIGH SPEED/HIGH DENSITY OPEN PIN FIELD TERMINAL ARRAY; STRAIGHT; 160PINS
28	1	J3	KLDX-0202-B	KYCON	KLDX-0202- B	CONNECTOR; FEMALE; THROUGH HOLE; DC POWER JACK; RIGHT ANGLE; 3PINS
29	8	JU1, JU4, JU5, JU8, JU11, JU12, JU23, JU35	PEC03DAAN	SULLINS ELECTRONICS CORP.	PEC03DAAN	CONNECTOR; MALE; THROUGH HOLE; BREAKAWAY; STRAIGHT THROUGH; 6PINS; -65 DEGC TO +125 DEGC
30	4	JU2, JU6, JU9, JU13	PEC05DAAN	SULLINS ELECTRONICS CORP.	PEC05DAAN	CONNECTOR; MALE; THROUGH HOLE; BREAKAWAY; STRAIGHT; 10PINS; -65 DEGC TO +125 DEGC
31	1	JU3	PEC08DAAN	SULLINS ELECTRONICS CORP.	PEC08DAAN	CONNECTOR; MALE; THROUGH HOLE; BREAKAWAY; STRAIGHT; 16PINS; -65 DEGC TO +125 DEGC
32	3	JU16, JU17, JU31	PCC03SAAN	SULLINS	PCC03SAAN	CONNECTOR; MALE; THROUGH HOLE; BREAKAWAY; STRAIGHT THROUGH; 3PINS; -65 DEGC TO +125 DEGC
33	1	JU18	TSW-110-26-T-T	SAMTEC	TSW-110-26- T-T	CONNECTOR; MALE; THROUGH HOLE; TSW SERIES; STRAIGHT; 30PINS
34	1	JU20	PEC02SAAN	SULLINS	PEC02SAAN	CONNECTOR; MALE; THROUGH HOLE; BREAKAWAY; STRAIGHT; 2PINS
35	4	JU22, JU24, JU25, JU36	PEC02DAAN	SULLINS ELECTRONIC CORP.	PEC02DAAN	CONNECTOR; MALE; THROUGH HOLE; BREAKAWAY; STRAIGHT; 4PINS
36	1	JU30	282834-2	TE CONNECTIVITY	282834-2	CONNECTOR; FEMALE; THROUGH HOLE; 2.54MM PITCH; SIDE WIRE ENTRY STACKING TERMINAL BLOCK ; STRAIGHT; 2PINS; -40 DEGC TO + 105 DEGC
37	2	JU32, JU33	PBC02DAAN	SULLINS ELECTRONIC CORP.	PBC02DAAN	CONNECTOR; MALE; THROUGH HOLE; BREAKAWAY; STRAIGHT; 4PINS

38	1	JU34	PEC04DAAN	SULLINS ELECTRONICS CORP.	PEC04DAAN	CONNECTOR; MALE; THROUGH HOLE; BREAKAWAY; STRAIGHT; 8PINS
39	4	L1-L4	LBC3225T330KR	TAIYO YUDEN	33UH	INDUCTOR; SMT (1210); WIREWOUND CHIP; 33UH; TOL=+/-10%; 0.3A
40	15	R1-R4, R37, R38, R50, R53, R92, R97, R105, R111, R121-R123	CRCW06030000ZS; MCR03EZPJ000; ERJ-3GEY0R00	VISHAY DALE/ROHM/PANASONIC	0	RESISTOR; 0603; 0 OHM; 0%; JUMPER; 0.10W; THICK FILM
41	1	R5	RG1608N-101-W-T1	SUSUMU CO LTD.	100	RESISTOR; 0603; 100 OHM; 0.05%; 10PPM; 0.10W; THICK FILM
42	4	R7-R10	RNCF0603BKC2R21	STACKPOLE ELECTRONICS INC.	2.21	RESISTOR; 0603; 2.21 OHM; 0.1%; 50PPM; 0.063W; THIN FILM
43	15	R11, R12, R36, R39-R41, R48, R49, R51, R52, R54, R61, R62, R84, R85	SEE NOTES	VISHAY DALE	33	RESISTOR; 0603; 33 OHM; 1%; 100PPM; 0.10W; THICK FILM
44	16	R13-R16, R20-R22, R25-R27, R31-R33, R71-R73	RN73C1J2K0B; 5-1614352-1	TE CONNECTIVITY	2K	RESISTOR; 0603; 2K OHM; 0.1%; 10PPM; 0.063W; METAL FILM
45	12	R17, R23, R28, R34, R75, R76, R80, R81, R93, R94, R104, R112	288-0603-1.0K-RC	XICON	1K	RESISTOR, 0603, 1K, 0.1%, 10PPM, 1/16W, THIN FILM
46	12	R18, R24, R29, R35, R90, R91, R95, R96, R106, R107, R109, R110	PCF0603R-2K0B	TT ELECTRONICS	2K	RESISTOR; 0603; 2K OHM; 0.1%; 25PPM; 0.063W; METAL FILM
47	1	R19	CRCW0603330KFK	VISHAY DALE	330K	RESISTOR, 0603, 330K OHM, 1%, 100PPM, 0.10W, THICK FILM
48	1	R30	CRCW06031M50FK	VISHAY DALE	1.5M	RESISTOR, 0603, 1.5M OHM, 1%, 100PPM, 0.10W, THICK FILM
49	13	R42-R45, R47, R56-R59, R63-R66	CRCW06031003FK; ERJ-3EKF1003	VISHAY DALE/PANASONIC	100K	RESISTOR; 0603; 100K; 1%; 100PPM; 0.10W; THICK FILM
50	1	R46	CRCW060349R9FK	VISHAY DALE	49.9	RESISTOR; 0603; 49.9 OHM; 1%; 100PPM; 0.10W; THICK FILM
51	16	R55, R60, R67-R70, R74, R77-R79, R82, R83, R98, R99, R108, R113	RN73C1J10RBTG; 1614350-2	TE CONNECTIVITY	10	RESISTOR; 0603; 10 OHM; 0.1%; 10PPM; 0.063W; THICK FILM
52	8	R86-R89, R100-R103	CRCW060375R0FK	VISHAY DALE	75	RESISTOR; 0603; 75 OHM; 1%; 100PPM; 0.10W; THICK FILM
53	2	R114, R115	MCR03EZPFX2002; ERJ-3EKF2002	ROHM; PANASONIC	20K	RESISTOR; 0603; 20K OHM; 1%; 100PPM; 0.10W; THICK FILM
54	1	R116	CRCW06031001FK; ERJ-3EKF1001V	VISHAY DALE; PANASONIC	1K	RESISTOR; 0603; 1K; 1%; 100PPM; 0.10W; THICK FILM
55	2	R117, R119	CRCW0603820KFK	VISHAY DALE	820K	RESISTOR, 0603, 820K OHM, 1%, 100PPM, 0.10W, THICK FILM
56	2	R118, R120	RC0603FR-0771K5L	YAGEO PHYCOMP	71.5K	RESISTOR; 0603; 71.5K OHM; 1%; 100PPM; 0.10W; THICK FILM

57	14	SU1, SU2, SU4-SU6, SU8, SU9, SU11-SU13, SU3_1-SU3_4	STC02SYAN	SULLINS ELECTRONICS CORP.	STC02SYAN	TEST POINT; JUMPER; STR; TOTAL LENGTH=0.256IN; BLACK; INSULATION=PBT CONTACT=PHOSPHOR BRONZE; COPPER PLATED TIN OVERALL
58	15	SU16, SU17, SU32-SU36, SU22_1, SU22_2, SU23_1, SU23_2, SU24_1, SU24_2, SU25_1, SU25_2	2012J-CR	JAMECO VALUEPRO	2012J-CR	CONNECTOR; FEMALE; WIREMOUNT; SOCKET SHORTING BLOCK; CLOSED TOP; RED; STRAIGHT; 2PINS
59	8	SU31, SU18_1-SU18_7	GJWCL-B-R	JAMECO VALUEPRO	GJWCL-B-R	CONNECTOR; FEMALE; WIREMOUNT; SOCKET SHORTING BLOCK; CLOSED TOP; BLUE; STRAIGHT; 2PINS
60	1	T1	TGM-H240V8LF	HALO ELECTRONICS, INC	TGM-H240V8LF	TRANSFORMER; SMT; 1:1:1.3:1.3; DC/DC CONVERTER
61	12	U10_6, U12_6, U15_6, U16_6, TP_INV+A, TP_INV+B, TP_INV-A, TP_INV-B, TP_NONINV+A, TP_NONINV+B, TP_NONINV-A, TP_NONINV-B	5009	KEYSTONE	N/A	TEST POINT; PIN DIA=0.125IN; TOTAL LENGTH=0.35IN; BOARD HOLE=0.063IN; YELLOW; PHOSPHOR BRONZE WIRE SILVER PLATE FINISH; RECOMMENDED FOR BOARD THICKNESS=0.062IN; NOT FOR COLD TEST
62	1	U1	MAX11958ETP+	MAXIM	MAX11958ETP+	EVKIT PART - IC; MAX11958; AZ10A; PACKAGE CODE T3255MK-2
63	1	U2	MAX13256ATB+	MAXIM	MAX13256ATB+	IC; DRV; 36V H-BRIDGE TRANSFORMER DRIVER FOR ISOLATED SUPPLIES; TDFN10-EP 3X3
64	3	U3, U18, U22	MAX14935FAWE+	MAXIM	MAX14935FAWE+	IC; DISO; FOUR-CHANNEL; 150MBPS; 5KV DIGITAL ISOLATOR; WSOIC16 300MIL
65	1	U4	TPS7A4901DGN	TEXAS INSTRUMENTS	TPS7A4901DGN	IC; VREG; ULTRALOW-NOISE, POSITIVE LINEAR REGULATOR; MSOP8-EP 300MIL
66	1	U6	TPS7A3001DGN	TEXAS INSTRUMENTS	TPS7A3001DGN	IC; VREG; ULTRALOW-NOISE, NEGATIVE LINEAR REGULATOR; MSOP8-EP 300MIL
67	10	U7, U8, U10-U16, U20	MAX9632AUA+	MAXIM	MAX9632AUA+	IC; OPAMP; PRECISION, LOW-NOISE, WIDE-BAND AMPLIFIER; UMAX8 ; -40 DEGC TO +125 DEGC
68	2	U9, U19	MAX9632AUA+	MAXIM	MAX9632AUA+	IC; OPAMP; PRECISION, LOW-NOISE, WIDE-BAND AMPLIFIER; UMAX8 ; -40 DEGC TO +125 DEGC
69	1	U17	93LC66BT-I/OT	MICROCHIP	93LC66BT-I/OT	IC; EPROM; 4K MICROWIRE SERIAL EEPROM; SOT23-6
70	1	U21	74LVC1G126GV	NXP	74LVC1G126GV	IC; DRV; SINGLE BUS BUFFER/LINE DRIVER; 3-STATE; SOT753
71	1	U23	MAX15006BATT+	MAXIM	MAX15006BATT+	IC; VREG; ULTRA-LOW QUIESCENT-CURRENT LINEAR REGULATOR; TDFN6-EP 3X3
72	3	U26, U27, U29	MAX8510EXK18	MAXIM	MAX8510EXK18	IC; VREG; ULTRA-LOW-NOISE; HIGH PSRR; LOW-DROPOUT; 0.12A LINEAR REGULATOR; SC70-5
73	2	U28, U30	MAX8510EXK33+	MAXIM	MAX8510EXK33+	IC; VREG; ULTRA-LOW-NOISE; HIGH PSRR; LOW-DROPOUT; 0.12A LINEAR REGULATOR; SC70-5

74	1	U36	MAX6126AASA30+	MAXIM	MAX6126AA SA30	SERIES VOLTAGE REFERENCE
75	1		MAX119XX	MAXIM	PCB	PCB: MAX119XX
TOTAL	437					

DO NOT PURCHASE(DNP)

ITEM	QTY	REF DES	MFG PART #	MANUFACTURE R	VALUE	DESCRIPTION
1	12	C21, C22, C24, C25, C57, C58, C72, C87-C89, C161, C162	N/A	N/A	?	CAPACITOR; 0603 PACKAGE; GENERIC
2	20	TP1-TP7, DINA, DINB, SCLK, DOUTA, DOUTB, DVDDA, DVddb, REFP1A, REFP1B, REFP2A, REFP2B, REFVDDA, REFVddb	PEC01SAAN	SULLINS ELECTRONICS CORP	PEC01SAAN	CONNECTOR; MALE; THROUGH HOLE; BREAKAWAY; STRAIGHT; 1PIN
3	1	R6	N/A	N/A	?	RESISTOR; 0603 PACKAGE; GENERIC
TOTAL	33					

PACKOUT (These are DO NOT INSTALL parts and will be shipped with PCB)

ITEM	QTY	REF DES	MANUFACTURER	VALUE	DESCRIPTI ON	STATUS
1	1	PACKOUT	N/A	?	BOX;SMALL BROWN 9 3/16"X7"X1 1/4" - PACKOUT	EVKIT-NOT FOR TEST
2	1	PACKOUT	N/A	?	ESD BAG;+;BAG; STATIC SHIELD ZIP 8"X10"; W/ ESD LOGO	EVKIT-NOT FOR TEST
3	1	PACKOUT	N/A	?	PINK FOAM;FOA M;ANTI- STATIC PE 12inX12inX5 MM - PACKOUT	EVKIT-NOT FOR TEST

4	1	PACKOUT	N/A	?	WEB INSTRUCTIONS FOR MAXIM DATA SHEET	EVKIT-NOT FOR TEST
5	1	PACKOUT	N/A	?	LABEL(EV KIT BOX) - PACKOUT	EVKIT-NOT FOR TEST
6	1	MEM1	KINGSTON TECHNOLOGY	SDC4/4GB	ACCESSORY; MEMORY CARD; 4GB; MICROSDHC SERIES; CLASS4	EVKIT-NOT FOR TEST
7	1		B00ET4KHJ2	CABLE MATTERS	USB 2.0 TO 10/100 ETHERNET ADAPTER	

TOTAL 7

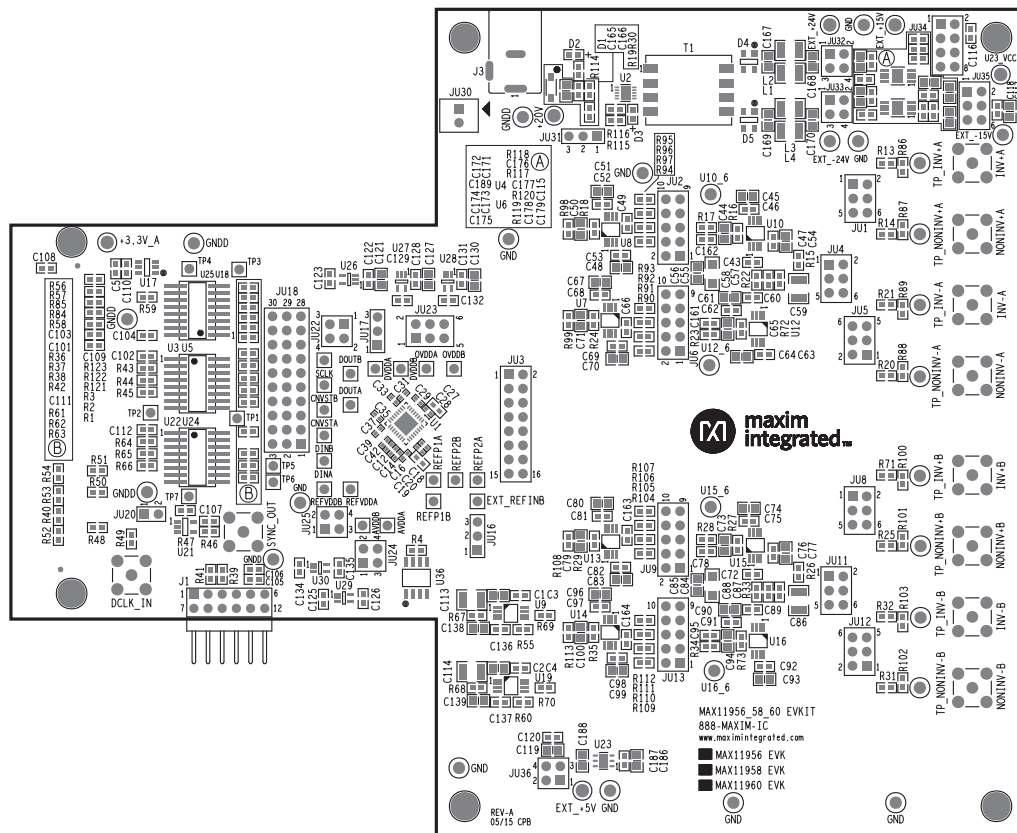

Component Placement Guide—Component Side

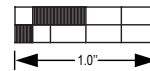
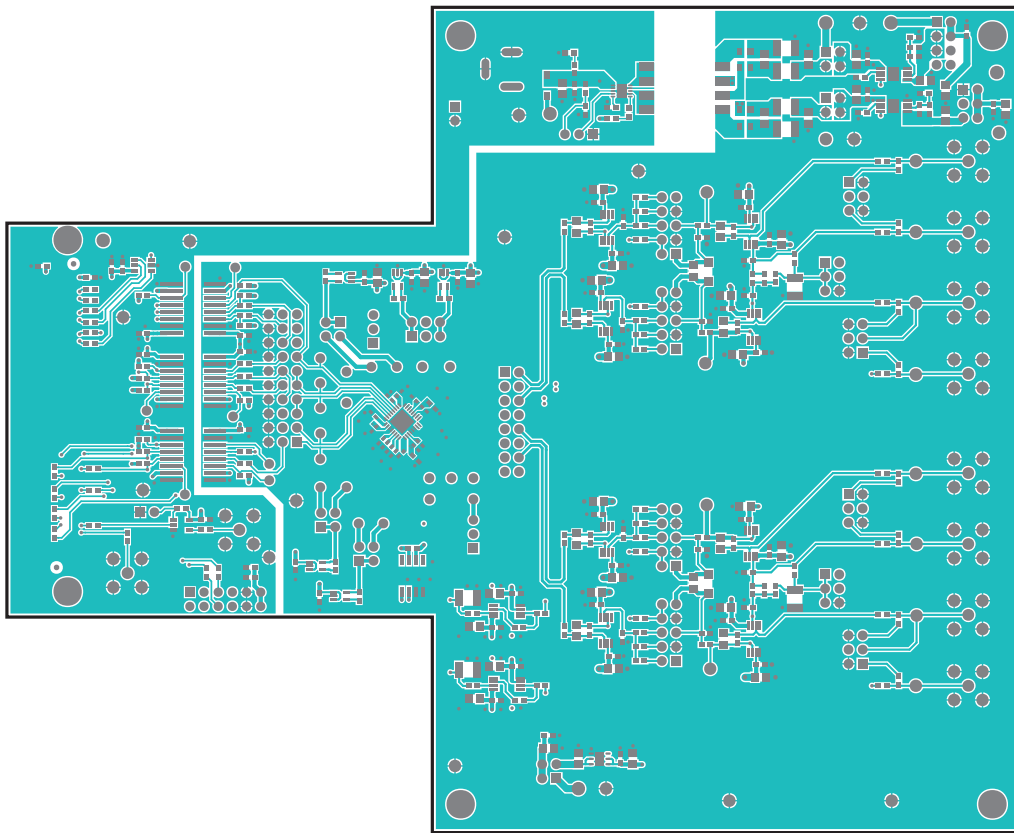

PCB Layout—Component Side

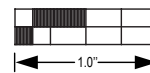
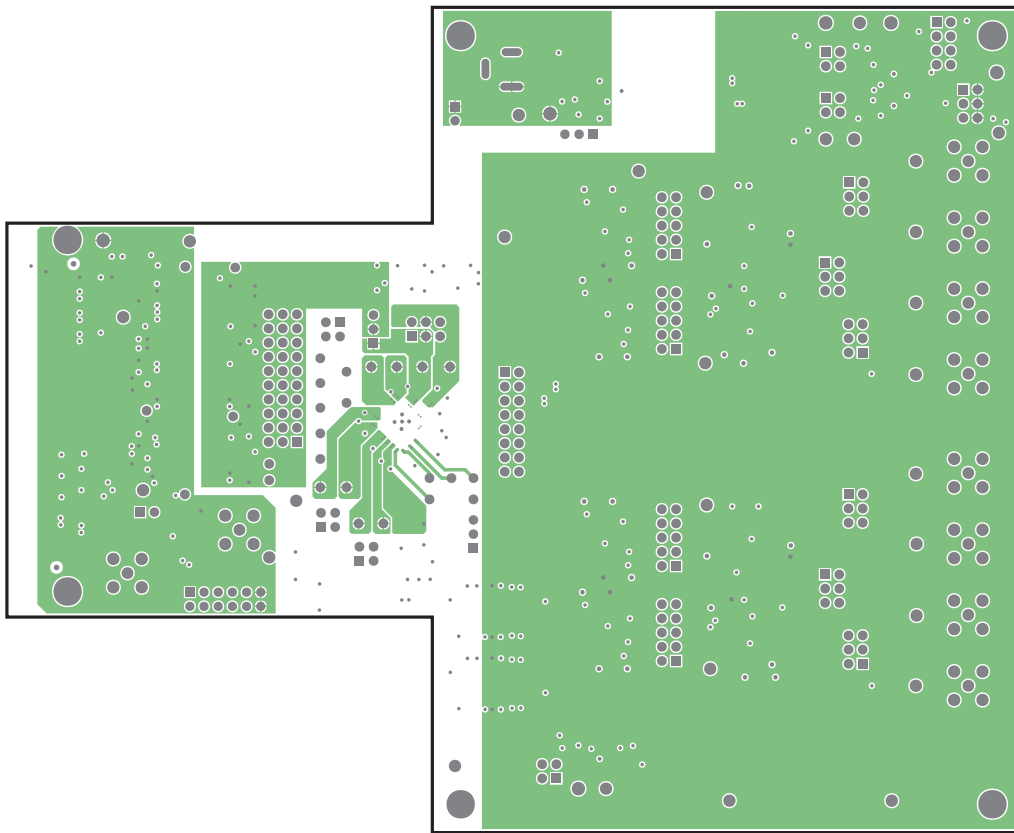

PCB Layout—Layer 3

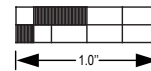
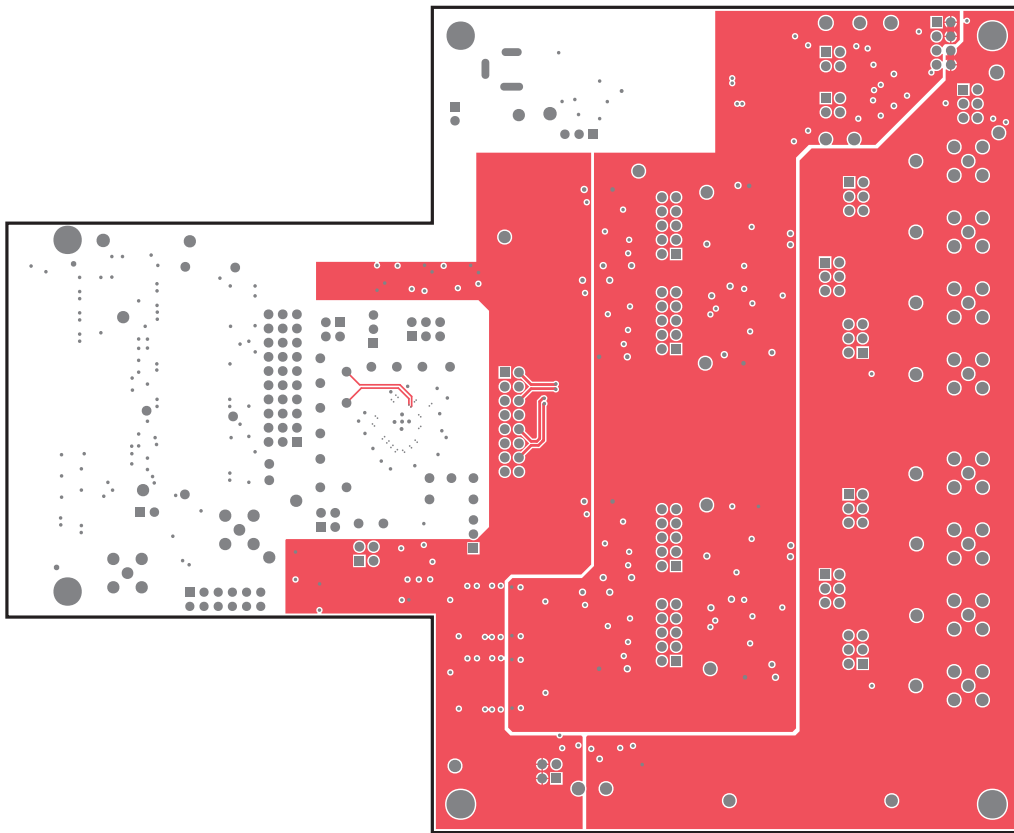

PCB Layout—Layer 4

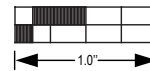
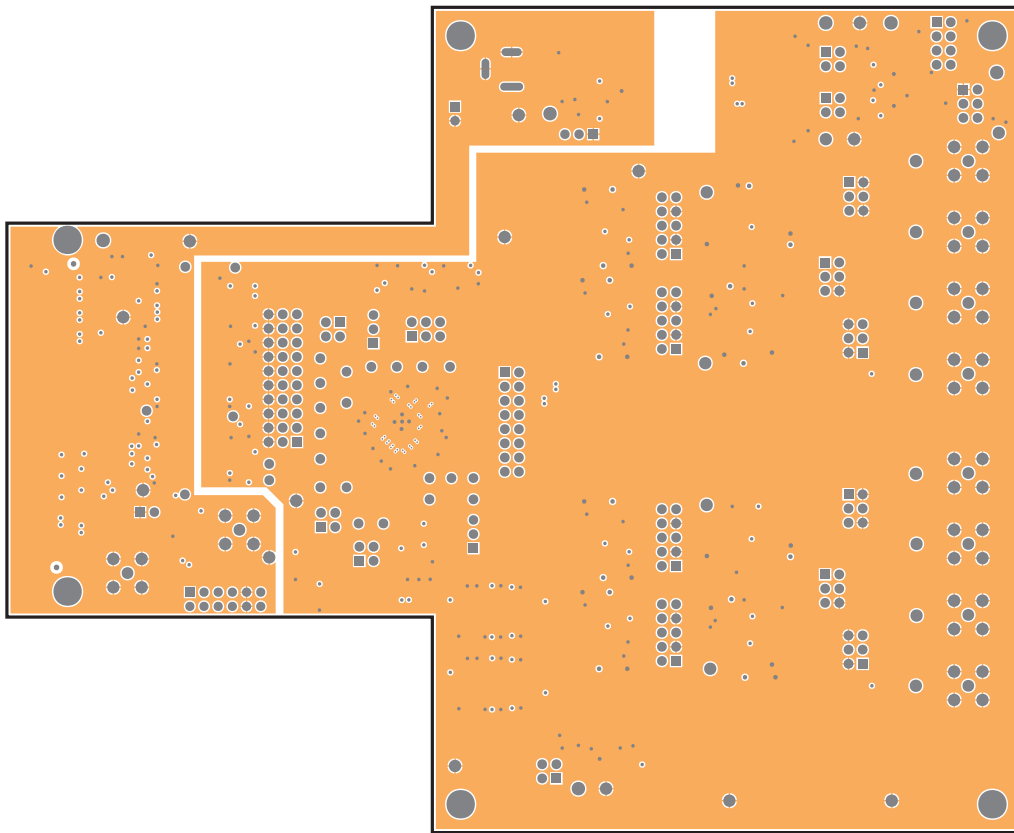

PCB Layout—Layer 5

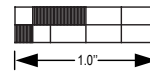
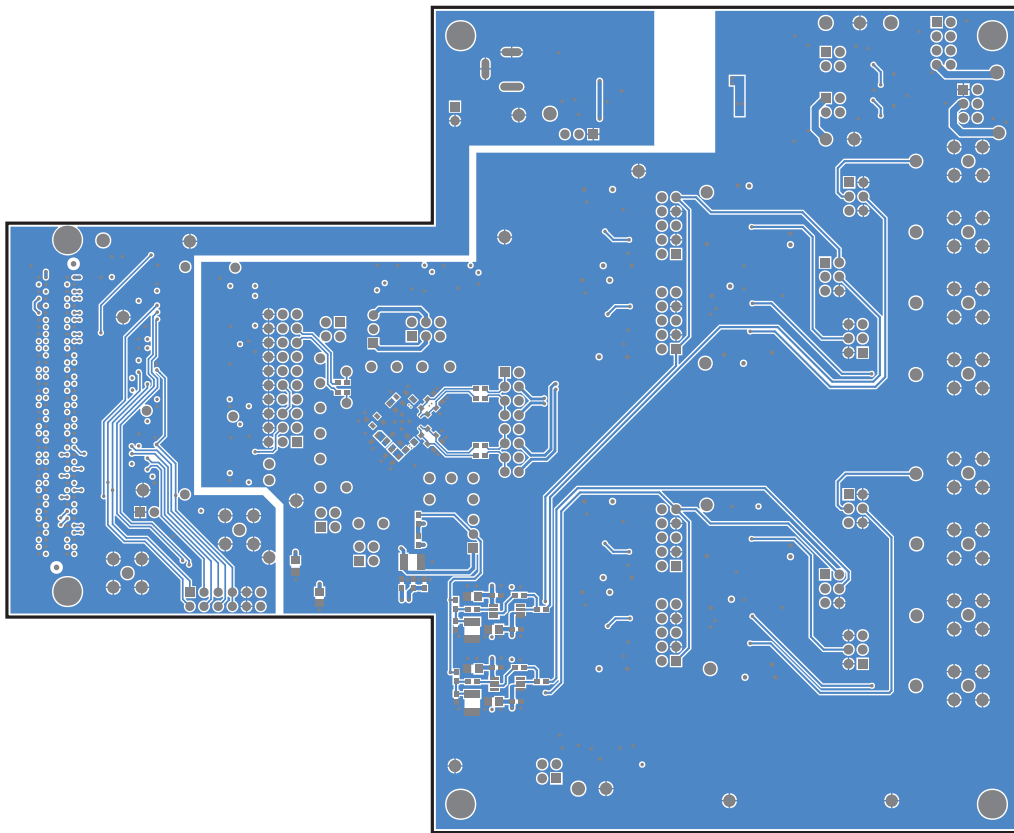

PCB Layout—Solder Side

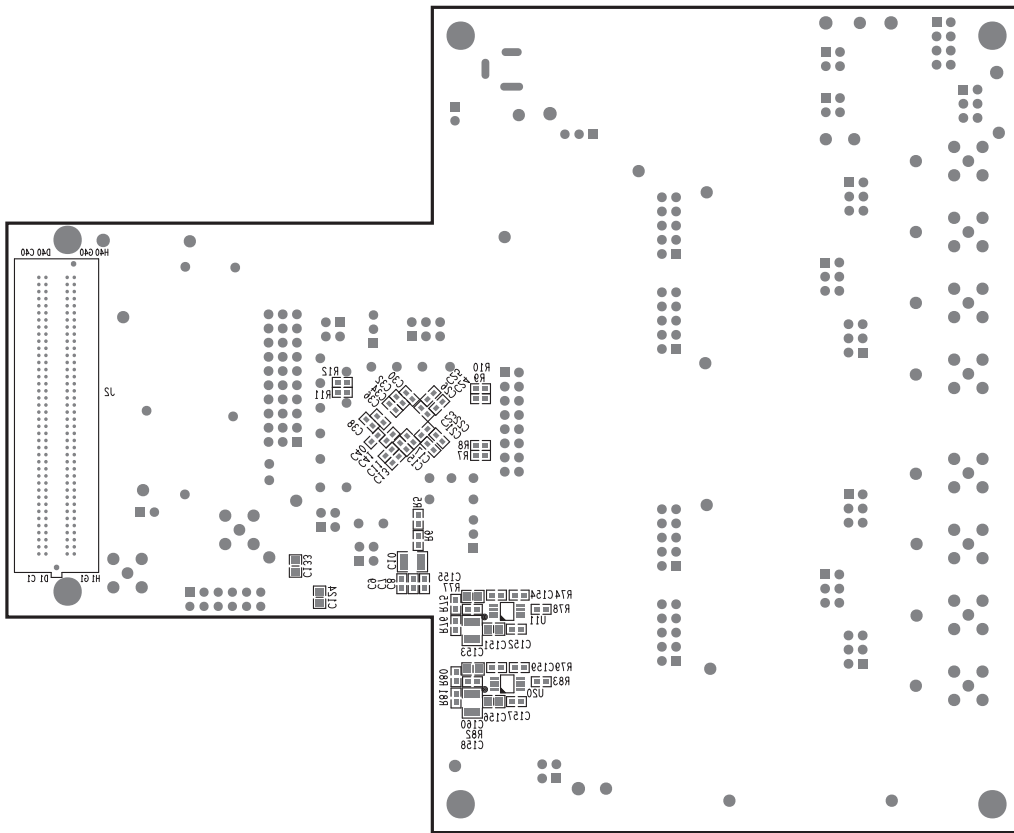

Component Placement Guide—Solder Side

