

**!NOT RECOMMENDED FOR NEW DESIGNS!**  
(LAST TIME BUY: 30<sup>th</sup> Oct 2020)

**RECOM**  
AC/DC Converter

## Features

- 2 and 3-phase operation
- Input voltage range: 320 – 575VAC
- Output trim range: 22.5 – 29.5VDC
- High electrical strength; high reliability
- Permanent overload and short-circuit protection
- Parallel operation capability
- International safety certification listing

## DIN-Rail Series

### Description

The REDIN/3AC is a series of rugged DIN rail power supplies for two and three-phase mains operation from 320 to 575VAC without the need of a neutral connection. Four versions with a maximum current limited output deliver 5A, 10A, 20A or 40A without derating up to +55°C. The output can be grounded via a third common output terminal. The LED signal on the front panel indicates that the output voltage remains within the wide adjustable range from 22.5 to 29.5VDC. The units are covered by international safety certificates and are intended for worldwide use. In power-hungry applications, the units can be connected in parallel with no need for additional components.

## REDIN120/3AC

**120 Watt**  
**3 Phase**  
**DIN-Rail**  
**Power Supply**



### Selection Guide

Part Number	nom. Input Voltage Range [VAC]	Output Voltage [VDC]	Output Adjustability [VDC]	Rated Current [A]	Efficiency <sup>(1)</sup> typ. [%]
REDIN120-24/3AC	400 - 500	24	22.5 - 29.5	5	89

#### Notes:

Note1: Efficiency is tested at nominal input and full load at +25°C ambient

### Model Numbering

**REDIN120-24/3AC**

nom. Output Power  Output Voltage

### Specifications (measured @ Ta= 25°C, nom.Vin, full load and after warm-up unless otherwise stated)

BASIC CHARACTERISTICS				
Parameter	Condition	Min.	Typ.	Max.
Input Voltage Range	3 phase operation	320VAC	400VAC	575VAC
	2 phase operation	360VAC	400VAC	575VAC
Input Current	3 phase operation	400VAC 500VAC	3 x 300mA 3 x 300mA	
	2 phase operation	400VAC 500VAC	2 x 650mA 2 x 500mA	
Inrush Current				15A
Return Voltage Immunity	24Vout		35VDC	
No Load Power Consumption				4W
Input Frequency Range		45Hz		65Hz
Output Voltage Trimming		22.5VDC		29.5VDC
Minimum Load		0%		
Start-up time	2/3 phase operation, 400VAC			1s
Rise time				2ms
Hold-up time	400VAC	20ms		
	480VAC	30ms		
Output Ripple & Noise	measured at 20MHz BW			30mVp-p
continued on next page				



UL60950-1 certified  
UL508 certified  
EN60950-1 certified  
CSA C22.2 No. 60950-01 certified  
EN55011 compliant  
EN50121-4 compliant  
CSA C22.2 No.107 certified  
EN61000-6-2 compliant  
EN61000-6-3 compliant

**Specifications** (measured @ Ta= 25°C, nom.Vin, full load and after warm-up unless otherwise stated)

Efficiency vs. Load @ 3 Phase Operation

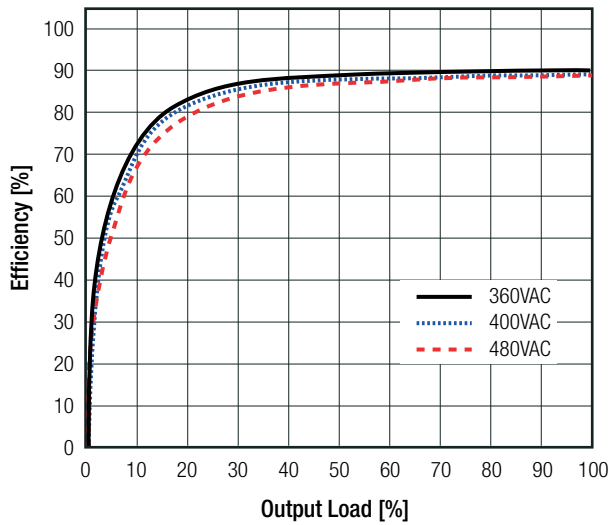

Power Dissipation vs. Load @ 3 Phase Operation

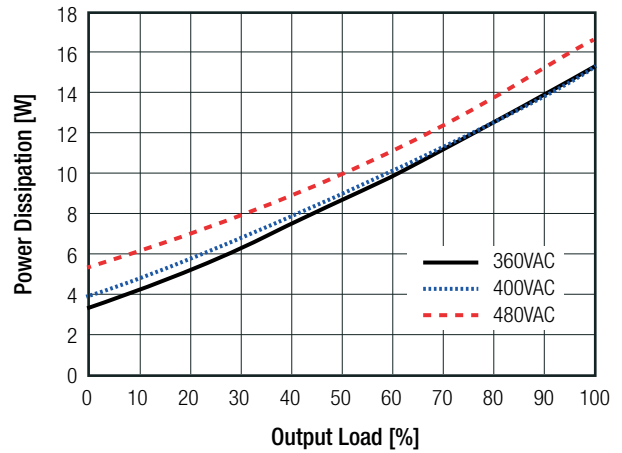

**REGULATION**

Parameter	Condition	Value
Output Accuracy		±1.0% max.
Line Regulation	10% change in input voltage	±0.1% typ.
Load Regulation	10% - 100% load	1.0% typ; 2.0% max.
Transient Response	25% load step change recovery time	200mV typ. 50ms typ.

Deviation vs. Load

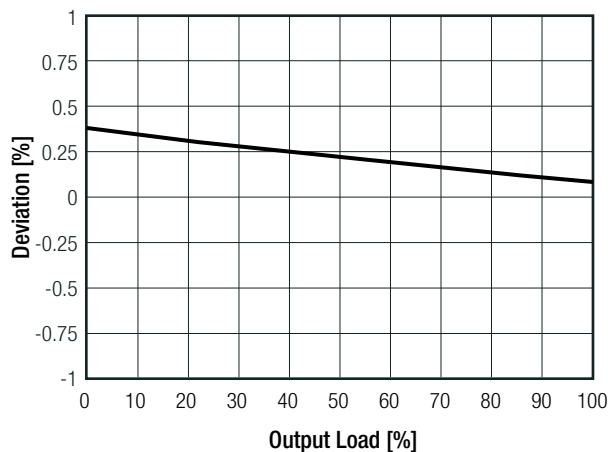

**PROTECTIONS**

Parameter	Type	Value
Input Fuse <sup>(2)</sup>	internal	F4A, fast blow
Recommended backup fuse for mains protection		3x 6A (characteristics B) 3x 10A (characteristics B) 3x 16A (characteristics B)
Short Circuit Protection (SCP)	below 100mΩ	>120% typ. power limiting
Over Voltage Protection (OVP)		>145% typ. auto recovery
Over Voltage Category (OVC)		OVC II

continued on next page

**Specifications** (measured @ Ta= 25°C, nom.Vin, full load and after warm-up unless otherwise stated)

PROTECTIONS			
Parameter	Type	Value	
Over Temperature Protection (OTP)		refer to note 3	
Over Current Protection (OCP)		>120% typ. auto recovery	
Power OK LED	"DC OK" Light green	Vout >21.5V	
Class of Equipment		Class I	
Isolation Voltage	tested for 1 minute	I/P to O/P	4242VDC
		O/P to PE	2348VDC
Isolation Resistance		10MΩ min.	
Insulation Grade		reinforced	

**Notes:**

Note2: Refer to local wiring regulations if input over-current protection is also required

Note3: Under thermal overload conditions, the device does not switch off; instead, the output current is limited as much as necessary to return internal operating temperatures to safe limits. After the device cools down, full output capacity is automatically restored

ENVIRONMENTAL			
Parameter	Condition	Value	
Operating Temperature Range	@ natural convection 0.1m/s	full load	-25°C to +55°C
		refer to derating graph	-25°C to +70°C
Maximum Case Temperature		+105°C	
Temperature Coefficient		0.05%/K	
Operating Altitude		2000m	
Operating Humidity	non-condensing at 25°C	5%-95% RH max.	
IP Rating		IP20	
Pollution Degree	according to EN50187	PD2	
Shock		30G in all directions	
Vibration		<15Hz, amplitude ±2.5mm 15Hz to 150Hz, 2.3G, 90min.	
MTBF	according to IEC61709	+25°C	500 x 10 <sup>3</sup> hours
		+55°C	60 x 10 <sup>3</sup> hours

**Derating Graph**

(@ Chamber and natural convection 0.1m/s)

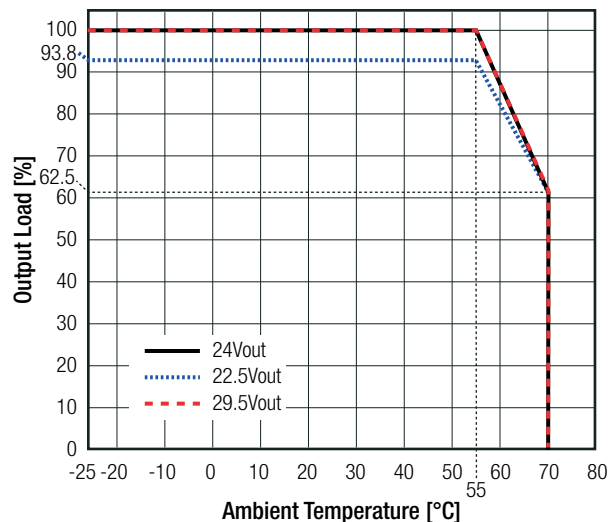

**Specifications** (measured @ Ta= 25°C, nom.Vin, full load and after warm-up unless otherwise stated)

<b>SAFETY AND CERTIFICATIONS</b>		
<b>Certificate Type</b>	<b>Report / File Number</b>	<b>Standard</b>
Information Technology Equipment, General Requirements for Safety	E196683	UL60950-1, 1st Edition: 2007 CSA C22.2 No. 60950-1, 1st Edition: 2006
Industrial Control Equipment	E470721	UL508, 17th-Edition CSA C22.2 No. 107.1-01, 3rd-Edition
Information Technology Equipment - General Requirements for Safety (LVD)		EN60950-1:2006+A2:2013
EAC	RU-AT.37.02367	TP TC 004/2011
RoHS 2+		RoHS 2011/65/EU + AM2015/863
<b>EMC Compliance</b>	<b>Report / Condition</b>	<b>Standard / Criterion</b>
Industrial, scientific and medical equipment – Radio frequency disturbance characteristics – Limits and methods of measurement		EN55011:1989 + A2:2002, Class B
ESD Electrostatic discharge immunity test	Air ±2, 4, 8kV Contact ±2, 4, 6, 8kV	EN61000-4-2:1995 + A1:2001, Criteria A
Radiated, radio-frequency, electromagnetic field immunity test	10V/m (80 - 3000MHz)	EN61000-4-3:2002 + A1:2006, Criteria A
Fast Transient and Burst Immunity	AC Power Port: ±4kV PE ±4kV DC Power Port ±2kV	EN61000-4-4:1995 + A2:2004, Criteria A
Surge Immunity	AC Power Port: L-N ±0.5, 1, 2kV L-PE ±4kV DC Power Port ±0.5, 1, 2kV	EN61000-4-5:1995 + A1:2006, Criteria A, B (L-PE)
Immunity to conducted disturbances, induced by radio-frequency fields	AC Power Port 10V DC Power Port 10V	EN61000-4-6:1996 + A1:2001, Criteria A
Voltage Dips and Interruptions	Voltage Dips >95% Voltage Dips 60% Voltage Dips 30% Voltage Interruptions > 95%	EN61000-4-11:2004, Criteria A EN61000-4-11:2004, Criteria B EN61000-4-11:2004, Criteria B EN61000-4-11:2004, Criteria B
Limits of Harmonic Current Emissions		EN61000-3-2:2000, Class A
Limits of Voltage Fluctuations & Flicker		EN61000-3-3:1995 + A1:2001
Railway applications – Electromagnetic compatibility Part 4: Emission and immunity of the signalling and telecommunications apparatus		EN50121-4:2006
<b>EMC Compliance (Generic Standards)</b>	<b>Report / Condition</b>	<b>Standard / Criterion</b>
Generic standards - Immunity standard for industrial environments		EN61000-6-2:2005
Generic standards - Emission standard for residential, commercial and light-industrial environments		EN61000-6-3:2007 + A1:2011

<b>DIMENSION and PHYSICAL CHARACTERISTICS</b>		
<b>Parameter</b>	<b>Type</b>	<b>Value</b>
Material	case cover	steel sheet, zinc-plated aluminium
Dimension (LxWxH)		115.0 x 40.0 x 130.0mm
Weight		600g typ.
continued on next page		

**Specifications** (measured @ Ta= 25°C, nom.Vin, full load and after warm-up unless otherwise stated)

Dimension Drawing (mm)

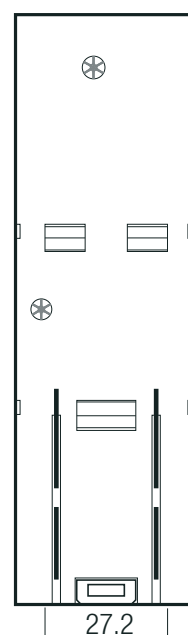
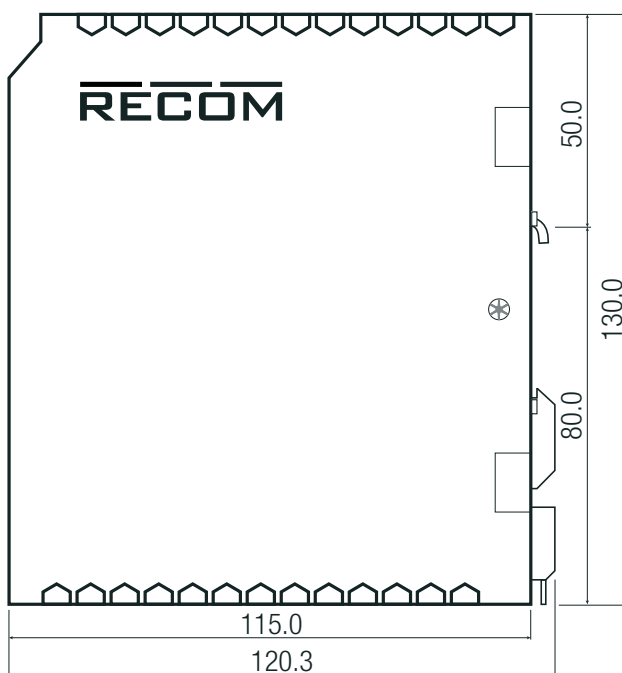
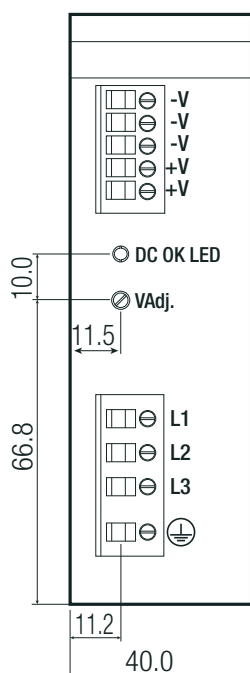
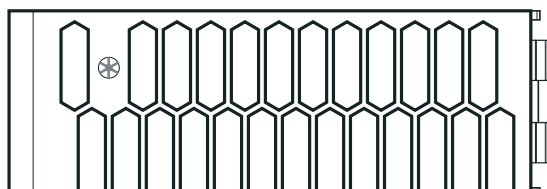

Terminals and Wiring	
Type	Screw Connector
Solid Wire	0.2 - 2.5mm <sup>2</sup>
Stranded Wire <sup>(4)</sup>	0.2 - 2.5mm <sup>2</sup>
American Wire Gauge Input	AWG 24-14
Amerivan Wire Gauge Output	AWG 16-12
Wire Stripping Length	9mm
Screwdriver (slotted / cross)	3.5mm
Recommended tightening torque	0.4Nm-0.5Nm
Tolerance: X.X ±0.5mm	

**Notes:**

Note4: The use of sleeve or ferrule terminations is recommended

**Specifications** (measured @ Ta= 25°C, nom.Vin, full load and after warm-up unless otherwise stated)

### INSTALLATION and APPLICATION

#### Mounting Instruction <sup>(5)</sup>

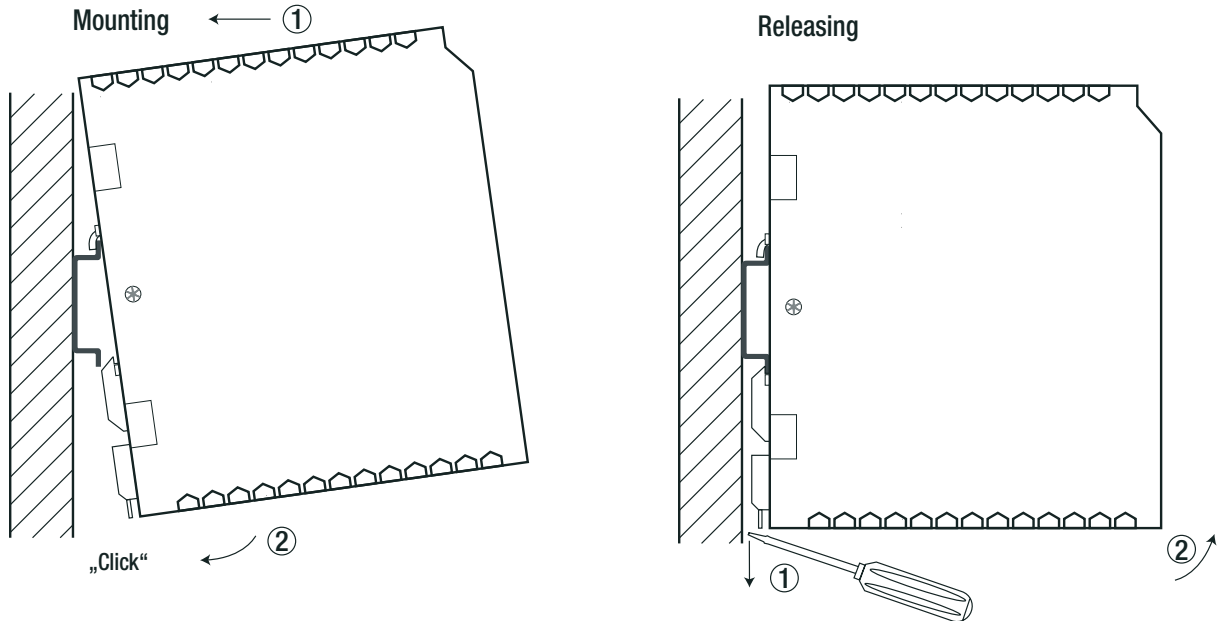

#### Mounting Multiple Power Supplies <sup>(6)</sup>

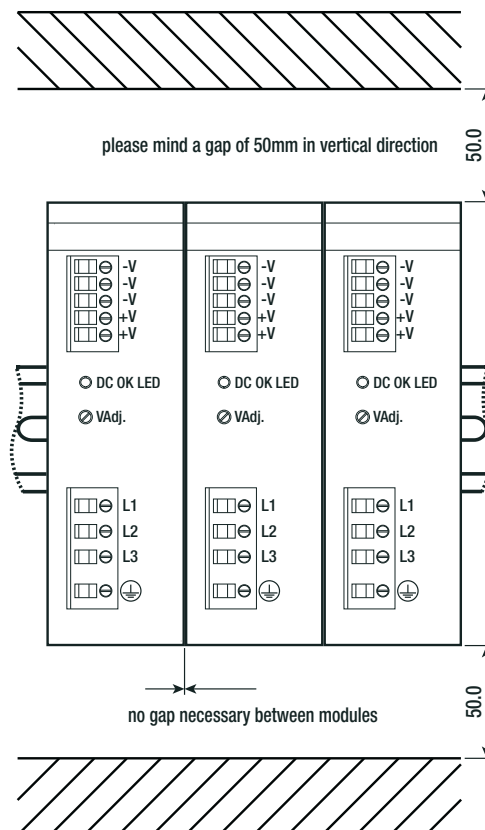

**Notes:**

Note4: The power supply unit can be snapped onto all DIN Rails in according with EN60715 and has to be mounted vertically

Note5: To guarantee sufficient convection, it is recommended to mint a 50.0 mm gap in vertical direction

**Specifications** (measured @ Ta= 25°C, nom.Vin, full load and after warm-up unless otherwise stated)

**2 Phase and 3 Phase Operation**

**3 Phase**

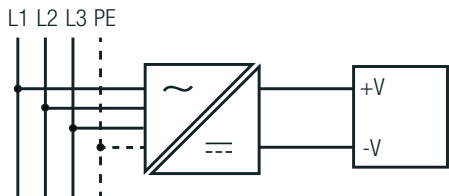

**2 Phase**

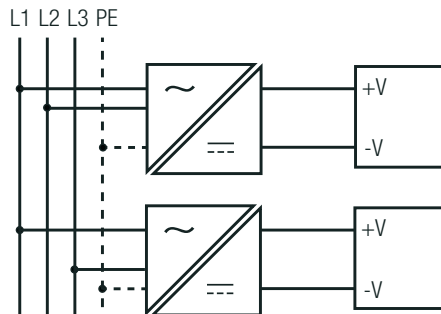

**Parallel Operation and Phase Redundancy**

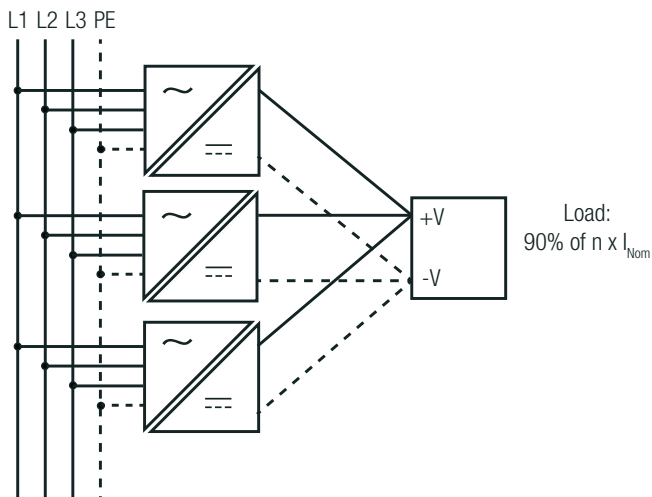

**Parallel Operation**

- 1) Adjust each power supply to the exact same output voltage with same load and cooling conditions.
- 2) Use the same wire length for each power supply (star connection) and energize all units at the same time to avoid triggering overload protection.
- 3) To prevent high reverse currents in the event of a secondary output fault, it is recommended to install a protective circuit at the output of each device when more than two power supplies are connected in parallel (e.g. decoupling diode or DC fuse).

For n parallel connected devices, the output current can be increased to 90% of  $n \times I_{nom}$ . A maximum of 5 devices can be connected in parallel.

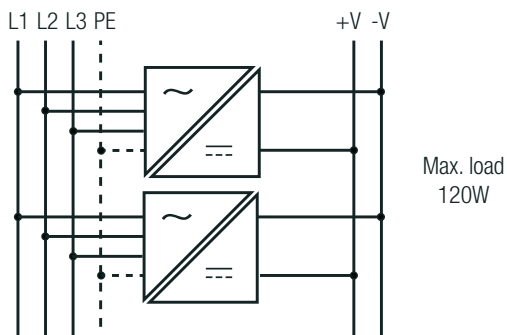

**Phase redundancy**

- 1) If any single phase fails, operation is still guaranteed.

**Specifications** (measured @ Ta= 25°C, nom.Vin, full load and after warm-up unless otherwise stated)

**Block Diagramm**

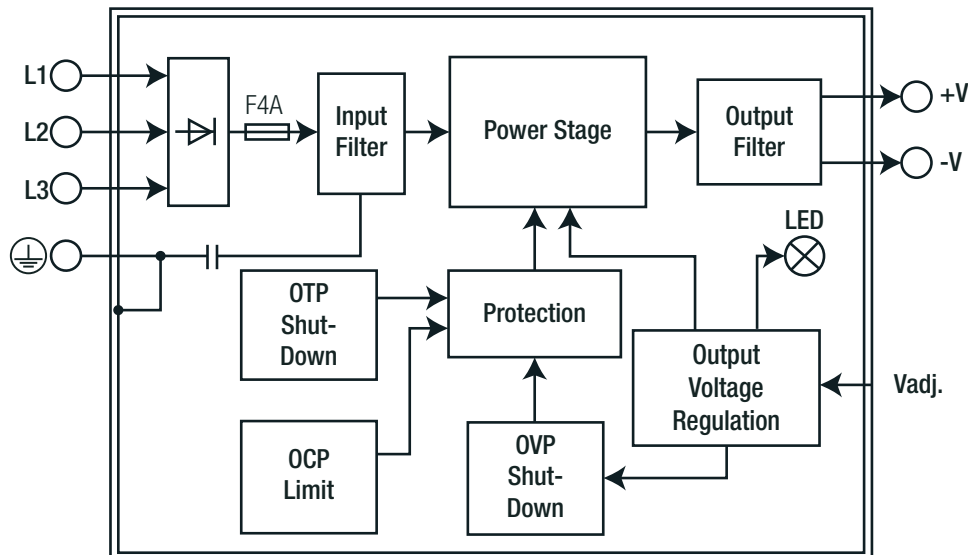

**PACKAGING INFORMATION**

Parameter	Type	Value
Packaging Dimension (LxWxH)	cardboard box	155.0 x 170.0 x 52.0mm
Packaging Quantity		1pcs
Storage Temperature Range		-40°C to +85°C
Storage Humidity	non-condensing	5% - 95% RH max.

The product information and specifications may be subject to changes even without prior written notice. The product has been designed for various applications; its suitability lies in the responsibility of each customer. The products are not authorized for use in safety-critical applications without RECOM's explicit written consent. A safety-critical application is an application where a failure may reasonably be expected to endanger or cause loss of life, inflict bodily harm or damage property. The applicant shall indemnify and hold harmless RECOM, its affiliated companies and its representatives against any damage claims in connection with the unauthorized use of RECOM products in such safety-critical applications.