

Comes with feet or flanges.

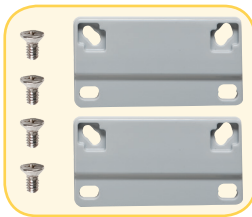

PREMIUM POLYCARBONATE ENCLOSURE

Features and Benefits

- Standard color – light gray with a gloss finish.
- Best material – bases, opaque covers and clear covers are all made of high-impact, UV resistant polycarbonate.
- Easy ordering – one part number includes base, lid, mounting feet or flanges and all lid fastening hardware (mounting panels sold separately).
- Flexible interior mounting – features the unique and patented Integra adjustable depth “T-Rail” back panel mounting system (back panel and adjustable brackets sold separately).
- Features multiple bosses for easy installation of devices and DIN rails.
- UL-50 / c-UL Listed (files # E229365, # E207562)

Our Premium Line enclosures are the most durable, non-metallic NEMA UL rated enclosures available. From the extremely versatile mounting options inside the enclosure to having the most off-the-shelf accessories, the Integra “Made In the USA” Premium Line enclosures provide great value to any application.

Mechanical and Thermal	Test Spec.	Unit	Premium Line
Instrumented Dart Impact @ 73° F		in/lb.	565
Falling Ball Impact @ 73° F	UL-746	in/lb.	900
Deflection Temperature @ 264 psi	ASTM D648	Deg. F	270
Modulus of Elasticity	ASTM D790	ksi	340
Temperature Range		Deg. F	-40 to 265

Flammable / UV Ratings	Test Spec.	Unit	Premium Line
Flame Rating - UL	UL 94	-	5VA
Outdoor UV Exposure	UL	-	F1



6064 P/N	4X IP66	6P IP68	Hinged Cover	Screw Cover	Opaque Cover	Clear Cover	Mounting Feet	Mounting Flange	Stainless Steel Locking Latch	Non-Metallic Locking Latch
H6064S	✓	✓		✓	✓		✓			
H6064SC	✓	✓		✓		✓	✓			
H6064SF	✓	✓		✓	✓			✓		
H6064SCF	✓	✓		✓		✓		✓		
H6064H	✓		✓	✓	✓		✓			
H6064HC	✓		✓	✓		✓	✓			
H6064HF	✓		✓	✓	✓			✓		
H6064HCF	✓		✓	✓		✓		✓		
H6064HLL	✓		✓		✓		✓		✓	
H6064HCLL	✓		✓			✓	✓		✓	
H6064HFLL	✓		✓		✓			✓	✓	
H6064HCFL	✓		✓			✓		✓	✓	
H6064HNL	✓		✓		✓		✓			✓
H6064HCNL	✓		✓			✓	✓			✓
H6064HFNL	✓		✓		✓			✓		✓
H6064HCFNL	✓		✓			✓		✓		✓
H6064H-6P	✓	✓	✓	✓	✓		✓			
H6064HC-6P	✓	✓	✓	✓		✓	✓			
H6064HF-6P	✓	✓	✓	✓	✓			✓		
H6064HCF-6P	✓	✓	✓	✓		✓		✓		

TORQUE SPECIFICATIONS - Mounting Brackets - 1/4"-20 x 0.25 SS, countersunk Phillips drive screws (torque limit = 20 in. lbs.) | Covers / Doors - Torque for corner screws is 10 in. lbs.





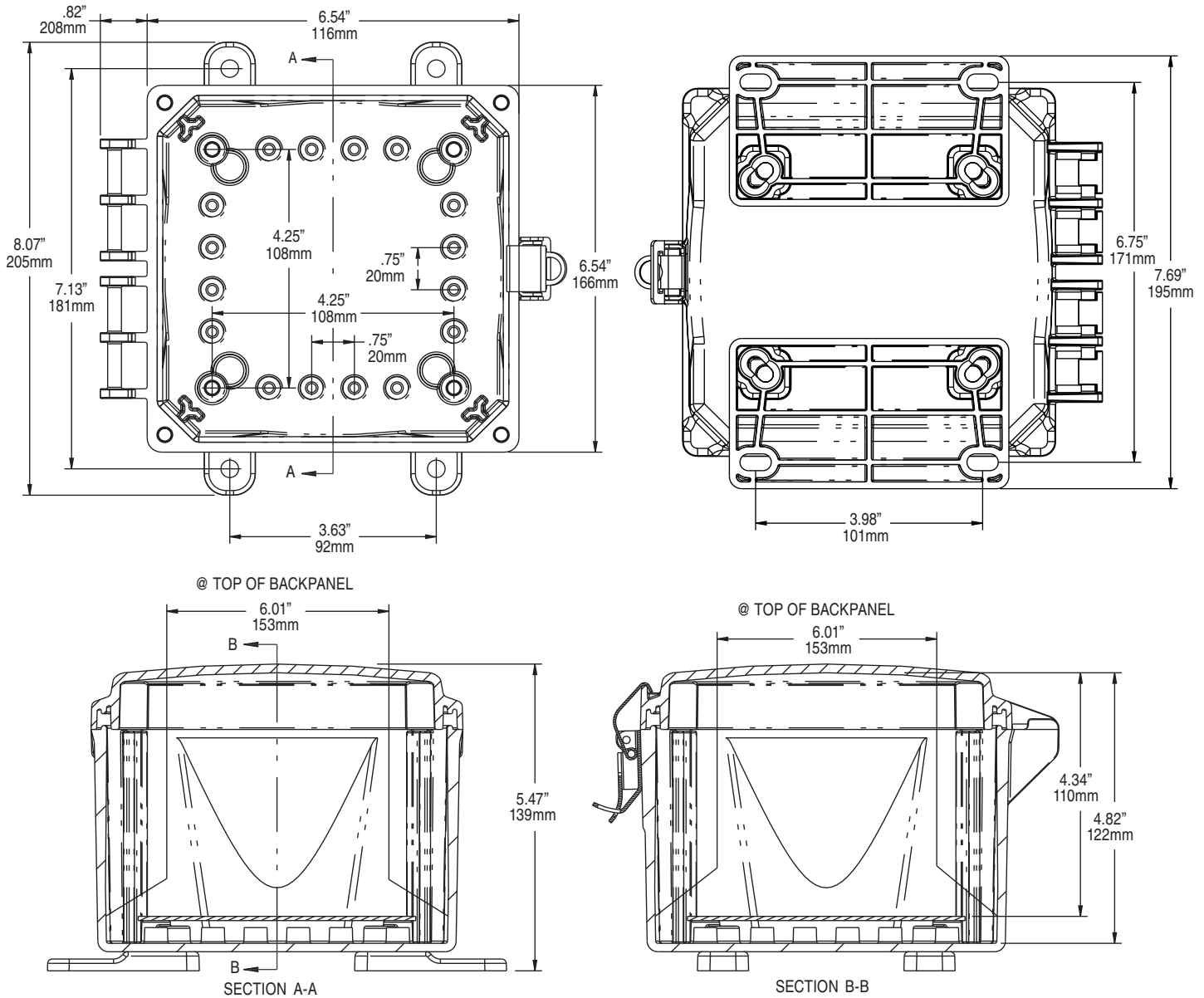





6X6X4 PREMIUM LINE

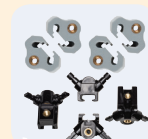

Register online to download this drawing off the Integra website at www.integraenclosures.com | Your company's logo or other information on the lid. Consult factory for details.

Accessories for 6x6x4 (For complete accessories, see pages 73-77)

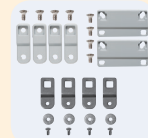
 <p>Back Panels ABP66 - Aluminum panel SBP66 - Steel panel PVCBP66 - PVC panel</p>	 <p>Aluminum Swing Out Panels ABP-66USP/USOPK - Complete panel kit ABP-66USP - Aluminum swing out panels only USOPK - Hardware only</p>	 <p>Back Panel Adjustment Kit BPAKG - Gray, Set Screw BPAKB - Black, Set Screw UBPAKG - Gray, Thumb Screw UBPAKB - Black Thumb Screw</p>
 <p>Air Vents VENT 3 - Aluminum louvered VENT 2 - Outdoor labyrinth</p>	 <p>Steel Swing Out Panels SBP-66USP/USOPK - Complete panel kit SBP-66USP - Steel swing out panels only USOPK - Hardware only</p>	 <p>Cord Grips IP68/NEMA 4X/6P rated See page 72 for more details and part numbers.</p>
 <p>Din Rail DIN 6 - 2 rails, 4 screws</p>	 <p>Pole Mounting Kit PMKG-26 - 2" pole PMKG-36 - 3" pole PMKG-46 - 4" pole PMKG-126 - 12" pole</p>	 <p>Mounting Feet & Flange Kits MFKG - Premium line feet MFKSS - Stainless steel feet MFLK6 - 6" Flange kit</p>