

Q3X Laser Contrast Sensor

Instruction Manual

Original Instructions
181485 Rev. E
12 July 2017
© Banner Engineering Corp. All rights reserved



181485

Contents

1 Product Description	3
1.1 Models	3
1.2 Overview	3
1.3 Features	3
1.3.1 Display and Indicators	4
1.3.2 Buttons	4
1.4 Laser Description and Safety Information	5
2 Installation	6
2.1 Install the Safety Label	6
2.2 Sensor Orientation	6
2.3 Sensor-to-Background Position	6
2.4 Sensor Mounting	6
2.5 Wiring Diagram	7
2.6 Cleaning and Maintenance	7
3 Sensor Programming	8
3.1 Setup Mode	8
3.1.1 Output Operation	8
3.1.2 TEACH Menu	8
3.1.3 Offset Percentage	8
3.1.4 Response Speed	9
3.1.5 Output Timing Delays	9
3.1.6 Input Wire Function	10
3.1.7 Sensitivity	10
3.1.8 Cut-Off Operation	10
3.1.9 Display View	11
3.1.10 Exit the Top Menu	11
3.1.11 Reset to Factory Defaults	11
3.2 Manual Adjustments	12
3.3 Remote Input	12
3.3.1 Select the TEACH mode using the Remote Input	12
3.3.2 Reset to Factory Defaults Using the Remote Input	13
3.4 Locking and Unlocking the Sensor Buttons	13
3.5 TEACH Procedures	14
3.5.1 Detection Reliability	14
3.5.2 Two-Point Static TEACH	14
3.5.3 Dynamic TEACH	15
3.5.4 Window Set	17
3.5.5 Light Set	18
3.5.6 Dark Set	19
3.6 Sync Master/Slave	20
3.7 Sensor Menu Map	21
4 Specifications	22
4.1 Performance Curves	23
4.2 Dimensions	24
5 Abbreviations	25
6 Troubleshooting	27
7 Accessories	28
7.1 Cordsets	28
7.2 Brackets	28
8 Contact Us	30
9 Banner Engineering Corp Limited Warranty	31

1 Product Description

Laser Expert™ diffuse sensor with bipolar (1 PNP & 1 NPN) output. Patent pending.

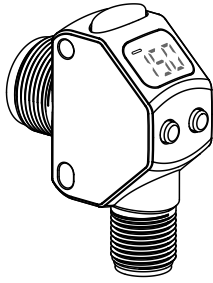

- Solves challenging part-detection applications with small contrast differences
- High-speed part detection as fast as 250 μ s, capturing up to 2,000 events per second
- Some models with background suppression allow reliable contrast detection with changing background conditions
- Angled three-digit display is easily viewed from multiple vantage points
- Display provides clear user feedback for easy setup, and bright output indicator provides high visibility of sensor operation
- Intuitive setup utilizing two tactile buttons located below the display
- Rugged nickel-plated zinc, laser-marked housing suitable for use even in environments where cutting fluids and oils might be present
- Robust immunity to fluorescent light interference



WARNING: Not To Be Used for Personnel Protection

Never use this device as a sensing device for personnel **protection**. Doing so could lead to serious injury or death. This device does not include the self-checking redundant circuitry necessary to allow its use in personnel safety applications. A sensor failure or malfunction can cause either an energized or de-energized sensor output condition.

1.1 Models

Model	Contrast Sensing Range	Background Suppression Distance	Output Type	Connection
Q3XTBLD-Q8	0 to 300 mm (11.81 in)	Not Applicable	Bipolar: 1 NPN, 1 PNP	5-pin M12 Euro-style integral connector
Q3XTBLD50-Q8	0 to 50 mm (1.97 in)	60 mm (2.36 in)		
Q3XTBLD100-Q8	0 to 100 mm (3.94 in)	120 mm (4.72 in)		
Q3XTBLD150-Q8	0 to 150 mm (5.91 in)	190 mm (7.48 in)		
Q3XTBLD200-Q8	0 to 200 mm (7.87 in)	280 mm (11.02 in)		

1.2 Overview

The Q3X Sensor is an Expert™ laser diffuse contrast sensor for low contrast detection application. Some models of the Q3X are able to ignore targets beyond a factory-set background suppression distance. This innovative combination of low contrast diffuse sensing of targets while ignoring objects beyond the region of interest eliminates the biggest problem of diffuse mode sensing, namely changing background conditions affecting the contrast detection.

The normal sensor state is Run mode. From Run mode, the switch point value can be changed and the selected TEACH method can be performed. The secondary sensor state is Setup mode. From Setup mode, the TEACH mode can be selected, all standard operating parameters can be adjusted, and a factory reset can be done.

1.3 Features

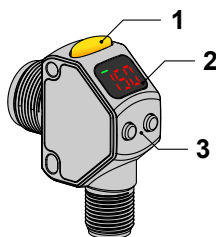

Figure 1. Sensor Features

1. Output Indicator (Amber)
2. Display
3. Buttons

1.3.1 Display and Indicators

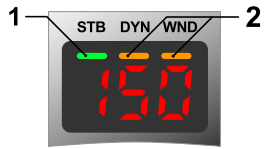

Figure 2. Display in Run Mode

1. Stability Indicator (STB = Green)
2. Active TEACH Indicators
 - DYN = Dynamic TEACH selected (Amber)
 - WND = Symmetric window thresholds are active (Amber)

In Run mode, the 3-digit, 7-segment display provides real time information about signal strength for all models and target position for models with a fixed background suppression distance. The numeric value of 0 to 990 represent the amount of the received light divided by the threshold, and represents the excess gain of the sensing event expressed as a percentage of the switch point. This value is called normalized signal strength (NSS). A NSS display range of 999 indicates a saturated received light signal, meaning that low contrast detection is not possible.

In single threshold teach modes (Two-Point Static, Dynamic, Light Set, or Dark Set), the output switches at a displayed value of 100 (excess gain of 1.0).

For models with a specified background suppression distance, $\overline{150}$ indicates that a target is present at a distance beyond the background suppression distance and is being suppressed. In Light Operate mode, the output switches off when $\overline{150}$ displays. For the background suppression models, the sensor's output state when displaying $\overline{150}$ can be controlled using the $\overline{150}$ menu. By default, the sensor treats a target in the background as a dark signal and honors the LO/DO selection.

A displayed value of $\overline{---$ indicates no light received or a loss of signal.

In Window Set teach mode, the value 100 represents the taught signal strength. The displayed value is the percentage of the received light divided by the taught signal strength. The output switches at displayed values above and below 100 as determined by the user-selected window offset percentage.

Output Indicator

- On—Outputs conducting (closed)
- Off—Outputs not conducting (open)

Stability Indicator (STB)

- On—Stable light signal received
- Flashing—Light intensity is within the switching threshold hysteresis band
- Off—No light signal received

Active TEACH Indicators (DYN and WND)

- DYN and WND off—Two-Point Static, Light Set, or Dark Set TEACH mode selected (Two-Point Static TEACH is the default).
- DYN and/or WND flashing—The sensor is in TEACH mode.
- DYN on—Dynamic TEACH mode selected
- WND on—Symmetric Window thresholds are active. The switch points are above and below 100 by the offset percentage

1.3.2 Buttons

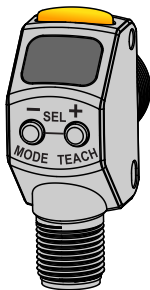

Use the sensor buttons (-)(MODE) and (+)(TEACH) to program the sensor. See [Sensor Programming](#) on page 8 for programming instructions.

(-)(MODE)

- Decrease gain: press and release (-)(MODE), then press and hold (-)(MODE) to rapidly decrease gain
- Enter Setup mode: press and hold (-)(MODE) for longer than 2 seconds
- Navigate the sensor menu: press (-)(MODE)

- Change setting values: press and hold (-)(MODE) to decrease numeric values

(+)(TEACH)

- Increase gain: press and release (+)(TEACH), then press and hold (+)(TEACH) to rapidly increase gain
- Start the currently selected TEACH mode: press and hold (+)(TEACH) for longer than 2 seconds (Two-Point Static TEACH is the default)
- Navigate the sensor menu: press (+)(TEACH)
- Change setting values: press and hold (+)(TEACH) to increase numeric values

(-)(MODE) and (+)(TEACH)

- Select menu items in Setup mode: press (-)(MODE) and (+)(TEACH) simultaneously
- Select and save a parameter and return to Run mode: press (-)(MODE) and (+)(TEACH) simultaneously for longer than 2 seconds

When navigating the menu systems, the menu items loop.

1.4 Laser Description and Safety Information



For Safe Laser Use - Class 2 Lasers

- Do not stare at the laser.
- Do not point the laser at a person's eye.
- Mount open laser beam paths either above or below eye level, where practical.
- Terminate the beam emitted by the laser product at the end of its useful path.



CAUTION: Use of controls or adjustments or performance of procedures other than those specified herein may result in hazardous radiation exposure. Do not attempt to disassemble this sensor for repair. A defective unit must be returned to the manufacturer.



CAUTION: Never stare directly into the sensor lens. Laser light can damage your eyes. Avoid placing any mirror-like object in the beam. Never use a mirror as a retroreflective target.

Class 2 Lasers

Class 2 lasers are lasers that emit visible radiation in the wavelength range from 400 nm to 700 nm, where eye protection is normally afforded by aversion responses, including the blink reflex. This reaction may be expected to provide adequate protection under reasonably foreseeable conditions of operation, including the use of optical instruments for intrabeam viewing.

Class 2 Laser Safety Notes

Low-power lasers are, by definition, incapable of causing eye injury within the duration of a blink (aversion response) of 0.25 seconds. They also must emit only visible wavelengths (400 to 700 nm). Therefore, an ocular hazard may exist only if individuals overcome their natural aversion to bright light and stare directly into the laser beam.



Laser wavelength: 655 nm
Output: < 0.42 mW
Pulse **Duration**: 5 μ s

2 Installation

2.1 Install the Safety Label

The safety label must be installed on Q3X sensors that are used in the United States.



Note: Position the label on the cable in a location that has minimal chemical exposure.

1. Remove the protective cover from the adhesive on the label.
2. Wrap the label around the Q3X cable, as shown.
3. Press the two halves of the label together.

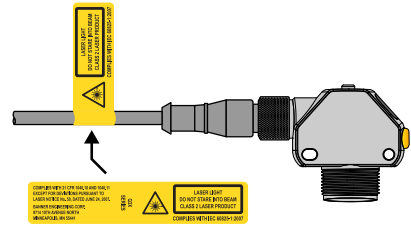

Figure 3. Safety Label Installation

2.2 Sensor Orientation

Correct sensor-to-target orientation is important to ensure proper sensing. To ensure reliable detection, orient the sensor as shown in relation to the target to be detected.

For models with background suppression, make sure the intended target is inside of the contrast sensing range and that any background objects are positioned beyond the background suppression distance.

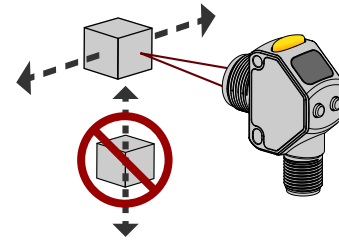
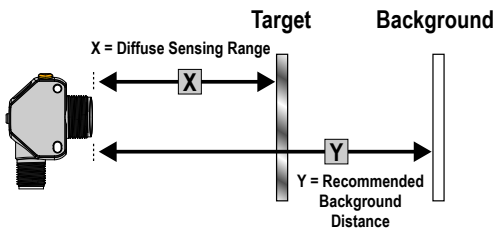

Figure 4. Optimal Orientation of Target to Sensor

2.3 Sensor-to-Background Position



Model Number	X	Y
LD50	50 mm (1.97 in)	60 mm (2.36 in)
LD100	100 mm (3.94 in)	120 mm (4.72 in)
LD150	150 mm (5.91 in)	190 mm (7.48 in)
LD200	200 mm (7.87 in)	280 mm (11.02 in)

Figure 5. Q3XBLD Contrast Detection versus Background Suppression

2.4 Sensor Mounting

1. If a bracket is needed, mount the sensor onto the bracket.
2. Mount the sensor (or the sensor and the bracket) to the machine or equipment at the desired location. Do not tighten at this time.
3. Check the sensor alignment.
4. Tighten the screws to secure the sensor (or the sensor and the bracket) in the aligned position.

2.5 Wiring Diagram

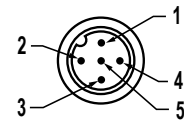
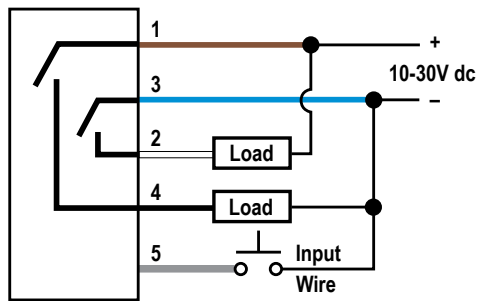

Key

- 1 = Brown
- 2 = White
- 3 = Blue
- 4 = Black
- 5 = Gray



Note: Open lead wires must be connected to a terminal block.



Note: The input wire function is user-selectable. The default for the input wire function is off (disabled).

2.6 Cleaning and Maintenance











Handle the sensor with care during installation and operation. Sensor windows soiled by fingerprints, dust, water, oil, etc. may create stray light that may degrade the peak performance of the sensor. Blow the window clear using filtered, compressed air, then clean as necessary using 70% isopropyl alcohol and cotton swabs or water and a soft cloth.

3 Sensor Programming

Program the sensor using the buttons on the sensor or the input wire (limited programming options; see [Remote Input](#) on page 12 for details).





In addition to programming the sensor, use the input wire to disable the buttons for security, preventing unauthorized or accidental programming changes. See [Locking and Unlocking the Sensor Buttons](#) on page 13 for more information.

3.1 Setup Mode

1. Access Setup mode from Run mode by pressing and holding MODE for longer than 2 seconds.
2. Use  or  to navigate through the top menu.
3. Select the desired submenu by pressing  and  simultaneously.
4. Press  or  to view the available options in the submenu.
5. Select a submenu option.
 - Press  and  simultaneously to select and save a submenu option and return to the top menu.
 - Press  and  simultaneously for longer than 2 seconds to select and save a submenu option and return to Run mode.



Note: The current submenu selection is solid, all other selections flash.

To exit Setup mode from the top menu and return to Run mode, navigate to **End** and press  and  simultaneously, or press and hold  and  simultaneously for longer than 2 seconds to return to Run mode from anywhere in the top menu.

3.1.1 Output **Operation out**

Use this menu to select the output operation mode. The default is light operate.

- **Lo**—Light operate. The output is on when the sensor detects a light state
- **do**—Dark operate. The output is on when the sensor detects a dark state

3.1.2 TEACH Menu **teach**

Use this menu to select the TEACH mode. The default is two-point static TEACH mode.

- **2Pt**—Two-point static TEACH
- **dyn**—Dynamic TEACH
- **win**—Window set
- **lt**—Light set
- **dr**—Dark set

After the TEACH mode is selected, from Run mode, press and hold TEACH for longer than 2 seconds to access the TEACH mode and teach the sensor. See [TEACH Procedures](#) on page 14 for additional information and remote input TEACH instructions.

When Window set, Light set, or Dark set are selected, the sensor returns to the Setup menu and the Offset Percentage menu (**Offset**) becomes available to set the offset percentage.

3.1.3 Offset Percentage **Offset**

Use this menu to select the offset percentage when Window set, Light set, or Dark set TEACH modes are selected. The default is 20% for Window and Light Set, and 50% for Dark Set.

Window and Light Set options:

- **min**—minimum
- **10**—10%
- **20**—20%
- **30**—30%

- 40 —40%
- 50 —50%

Dark Set options:

- $\bar{n} \bar{m}$ —minimum
- 25 —25%
- 50 —50%
- 100 —100%
- 200 —200%

3.1.4 Response Speed **SPd**

Use this menu to select the response speed. The default is 1 millisecond.

- 250 —250 microseconds
- 175 —1 millisecond
- 575 —5 milliseconds

Table 1: Tradeoffs

Response Speed	Repeatability	Crosstalk Immunity	High Efficiency Light Rejection
250 μ s	60 μ s	Disabled	Disabled
1 ms	300 μ s	Enabled	Disabled
5 ms	520 μ s	Enabled	Enabled
25 ms (Master-Slave Sync)	13 ms	Best for direct line of sight crosstalk	Enabled

3.1.5 Output Timing Delays **dLd**

Use this menu to select the output timing delay to be set. Only one delay type can be used at a time. The default is no delay.

- off —No delay
- on —Enables simultaneous on and off delay timers
- 15h —One-shot. Enables a one-shot, fixed output pulse duration

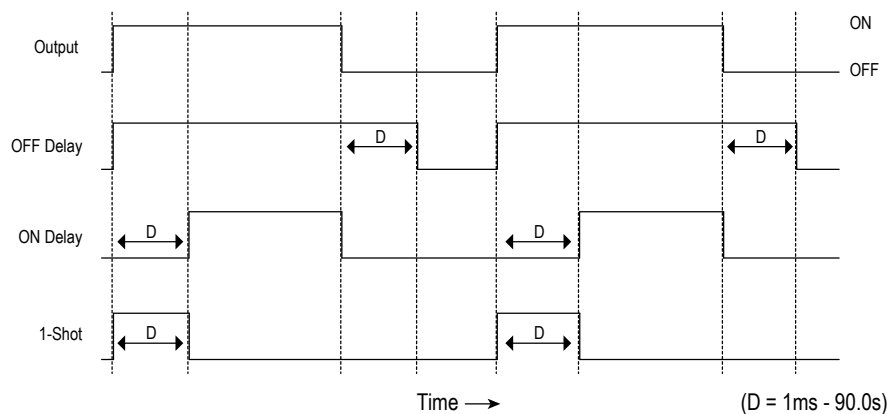

Figure 6. Output Timing Delays

When either **on** or **15h** is chosen, the sensor returns to the Setup menu and additional options become available to set the timer(s):

on

- **ond** —On delay

- **ofd** —Off delay

15h

- **dt!** —Delay timer



Note: For the one-shot timer:

- LO = On pulse when a target is detected in the light state
- DO = On pulse when a target is detected in the dark state

Delay Timer **and**, **ofd**, **dt!**

Use these menus to set the delay timers. These menus are only available if an output timing delay is selected.

- 1 to 9 ms in 1 ms increments
- 10 to 90 ms in 10 ms increments
- 100 to 900 ms in 100 ms increments
- 1.0 to 90.0 s in 1.0 s increments

For **and** and **ofd**, the default is 0.

For **dt!**, the default is:

- 1 ms when the response speed is either 250 μ s or 1 ms
- 10 ms when the response speed is 5 ms

Use **-** or **+** to scroll through the values. Millisecond values do not include the decimal point; seconds values include the decimal point.

3.1.6 Input Wire Function **inp**

Use this menu to select the input wire function. The default is off.

- **off** —Ignore all pulses
- **lof** —Laser off when pulled low
- **set** —Remote TEACH input
- **ast** —Master sync line output for two-sensor cross-talk avoidance
- **slw** —Slave sync line output for two-sensor cross-talk avoidance

To configure sensors for master-slave operation, see [Sync Master/Slave](#) on page 20.

3.1.7 Sensitivity **sen**

Use this menu to set the sensitivity. The default is standard.

- **hi** —High sensitivity. Use this setting for low contrast sensing
- **std** —Standard sensitivity
- **lo** —Low sensitivity. Use this setting to stabilize the output in high vibration applications

3.1.8 Cut-Off Operation **cto**

Use this menu to select cut-off operation. The default is **ldo**

- **ldo** — Output follows LO/DO selection; sensor treats target in background (or loss of signal) as the dark state.
- **off** — Output switches OFF when the target is beyond the background suppression distance.
- **on** — Output switches ON when the target is beyond the background suppression distance.

Table 2: Cut-off output settings and operation

	Output State Based on LO menu and LO/DO Selections	
	Target in Cut-Off	No Light Received (Loss of Signal)
LO	LO/DO	LO/DO
OFF	OFF	LO/DO
ON	ON	LO/DO



Note: The output may transition ON to OFF or OFF to ON when the target enters the diffuse sensing range. Consider an ON-Delay or the laser inhibit input if necessary.

3.1.9 Display View **dSP**

Use this menu to select the display view. The default is right-reading.

- **123** —Right-reading
- **E21** —Inverted
- **OFF** —Right-reading and the display enters sleep mode after 60 seconds
- **330** —Inverted and the display enters sleep mode after 60 seconds

When the sensor is in sleep mode, the display wakes with the first button press.

3.1.10 Exit the Top Menu **End**

Navigate to **End** and press TEACH and MODE together to exit the top menu and return to Run mode.

Setup mode can also be exited by pressing and holding **-** and **+** simultaneously for longer than 2 seconds from anywhere in the top menu.

3.1.11 Reset to Factory Defaults **rSt**

Use this menu to restore the sensor to the factory default settings. Select **no** to return to the sensor menu without restoring the defaults. Select **YES** to restore the sensor to the factory default settings and return to Run mode.

Factory Default Settings

Setting	Factory Default
Display view (dSP)	123 —Right-reading, no sleep mode
Input wire function (inp)	OFF —Ignore all pulses
Offset Percent (Pct)	20 —20%, Window and Light Set 50 —50%, Dark Set
Output operation (out)	Lo —Light operate
Output timing delays (dlY)	OFF —No delay
Response speed (SPd)	175 —1 ms
Sensitivity (SEN)	Std —Standard sensitivity
TEACH process selection (tch)	2Pt —Two-point static TEACH

3.2 Manual Adjustments

Manually increase or decrease gain using \ominus or \oplus .

1. From Run mode, press either \ominus or \oplus one time. The current signal strength value flashes slowly.
2. Press \ominus to decrease the sensor's gain or \oplus to increase the sensor's gain, or press and hold \ominus or \oplus to rapidly decrease or increase gain. After 1 second, the normalized signal strength flashes rapidly, the new setting is accepted, and the sensor returns to Run mode.

3.3 Remote Input

Use the input wire to program the sensor remotely. To program the sensor using the input wire, remote input must be enabled ($\text{rIP} = \text{SET}$, *Input Wire Function* on page 10). The remote input provides limited programming options (see *Figure 7* on page 12). Pulse the remote input according to the diagram and the instructions provided in this manual.

The length of the individual programming pulses is equal to the value T: $0.04 \text{ seconds} \leq T \leq 0.8 \text{ seconds}$.

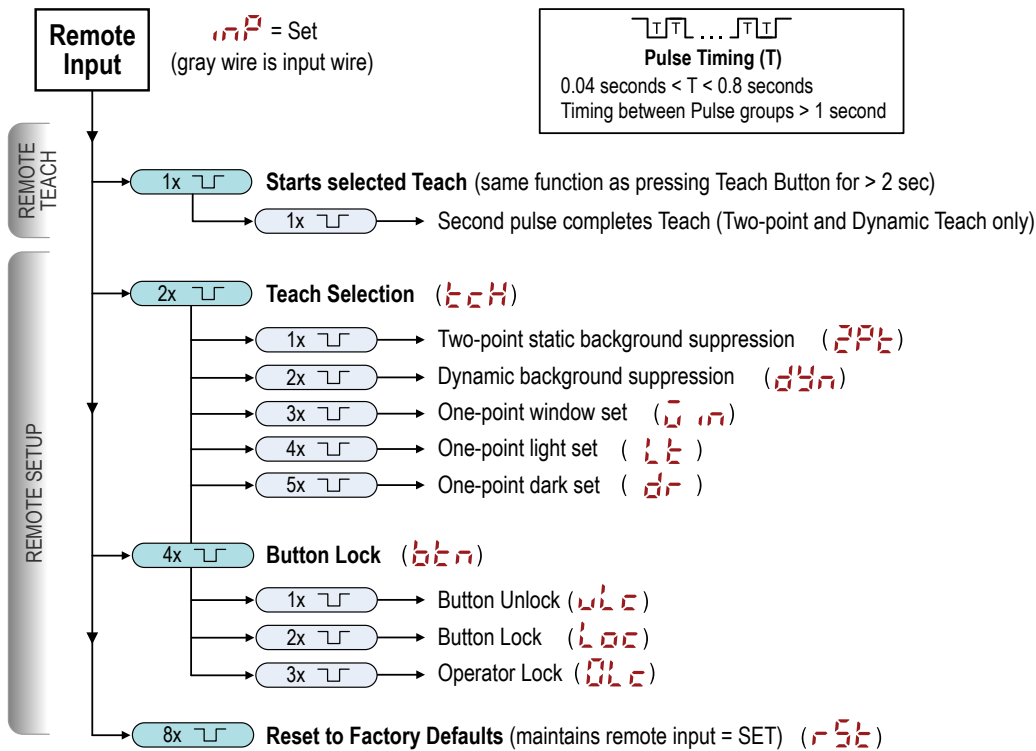
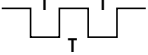



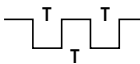
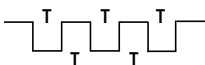

Figure 7. Remote Input Map

3.3.1 Select the TEACH mode using the Remote Input

1. Access the TEACH selection.

Action	Result
Double-pulse the remote input.	 tch displays.

2. Select the desired TEACH mode.

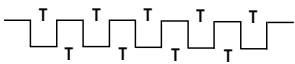
Action		Result
Pulses	TEACH Mode	The selected TEACH method displays for a few seconds and the sensor returns to Run mode.
1	 Two-point static TEACH	
2	 Dynamic TEACH	
3	 One-point window set	
4	 One-point light set	
5	 One-point dark set	

3.3.2 Reset to Factory Defaults Using the Remote Input

Eight-pulse the remote input to apply the factory defaults and return to Run mode.

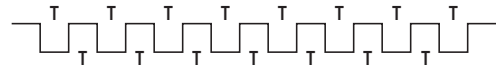

Note: The input wire function remains at remote teach input (**SET**).

3.4 Locking and Unlocking the Sensor **Buttons**

Use the lock and unlock feature to prevent unauthorized or accidental programming changes. There are three different settings available:

- **wlc** —The sensor is unlocked and all settings can be modified (default).
- **loc** —The sensor is locked and no changes can be made.
- **qlc** —The switch point value can be changed by teaching or manual adjustment, but no sensor settings can be changed through the menu.

When in **loc** mode, **loc** displays when (-)(MODE) or (+)(TEACH) are pressed.

When in **qlc** mode, **loc** displays when (-)(MODE) is pressed and held. To access the manual adjust options, briefly press and release (-)(MODE) or (+)(TEACH). To enter TEACH mode, press the (+)(TEACH) button and hold for longer than 2 seconds.

Button Instructions

To enter **loc** mode, hold **+** and press **-** four times. To enter **qlc** mode, hold **+** and press **-** seven times. Holding **+** and pressing **-** four times unlocks the sensor from either lock mode and the sensor displays **wlc**.

Remote Input Instructions

1. Access the remote input.

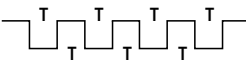
Action	Result
Four-pulse the remote input.	 The sensor is ready to have the button state defined and btn displays.

2. Lock or unlock the sensor buttons.

Action		Result
Single-pulse the remote input to unlock the sensor.		ULC displays and the sensor returns to Run mode.
Double-pulse the remote input to lock the sensor.		LCC displays and the sensor returns to Run mode.
Triple-pulse the remote input to apply the operator lock to the sensor.		OLC displays and the sensor returns to Run mode.

3.5 TEACH Procedures

3.5.1 Detection Reliability

After completing a TEACH, the detection reliability of the application can be assessed by comparing the displayed NSS value of the light and dark target conditions. The difference between the two displayed values is an indication of the contrast of the application.

Difference between Light and Dark target NSS values	Application reliability
> 10	Marginal
10 to 20	Low
20 to 40	Good
40 to 60	Robust
> 60	Excellent

3.5.2 Two-Point **Static** TEACH **2Pt**

Two-point TEACH sets a single switching threshold. The sensor centers the switch point between two taught conditions with the Output ON condition on one side and the Output OFF condition on the other.

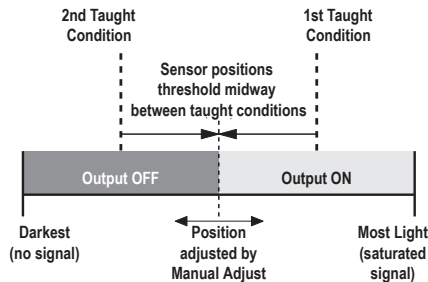

Figure 8. Two-Point TEACH (Light Operate shown)



Note: The sensor must be set to **TECH = 2Pt** to use the following instructions.



Note: To program the sensor using remote input, remote input must be enabled (**RP = Set**)

1. Present the target.

Method	Action	Result
Push Button	Present the first target. The sensor-to-target distance must be within the sensor's range.	The target's value displays.
Remote Input		

2. Start the TEACH mode.

Method	Action	Result
Push Button	Press and hold TEACH for longer than 2 seconds.	SET and 1st flash alternately on the display. The DYN and WND indicators flash.
Remote Input	No action required.	n/a

3. Teach the sensor.

Method	Action	Result
Push Button	Press TEACH to teach the target.	The sensor is taught the first target.
Remote Input	Single-pulse the remote input. 	SET and 2nd flash alternately on the display. The DYN and WND indicators flash.

4. Present the target.

Method	Action	Result
Push Button	Present the second target. The sensor-to-target distance must be within the sensor's range.	SET and 2nd flash alternately on the display. The DYN and WND indicators flash.
Remote Input		

5. Teach the sensor.

Method	Action	Result
Push Button	Press TEACH to teach the target.	The sensor is taught the second target and the sensor returns to Run mode.
Remote Input	Single-pulse the remote input. 	

Table 3: Expected TEACH Behavior for Two-Point Static TEACH

Condition	TEACH Result	Display
At least one taught condition is between the minimum and maximum signal level limits.	Sets the threshold between the two taught conditions.	The current NSS displays.
Both taught conditions are darker than the minimum signal value limit.	Sets the threshold at the minimum level. Sets the sensor at the maximum detection condition.	top briefly displays, and then the current NSS displays.
Both taught conditions are brighter than the maximum signal value limit.	Sets the threshold at the maximum level. Sets the sensor at the minimum detection condition.	bot briefly displays, and then the current NSS displays.
Both taught conditions are at the same signal level. This is a Calibration Set.	Sets the threshold slightly below the two taught conditions.	CAL briefly displays, and then the current NSS displays.

3.5.3 Dynamic TEACH 

Dynamic TEACH sets a single switching threshold during machine run conditions. Dynamic TEACH is recommended for applications where a machine or process may not be stopped for teaching. During Dynamic TEACH, the sensor takes multiple samples of the light and dark conditions and automatically sets the switch point at the optimum level.

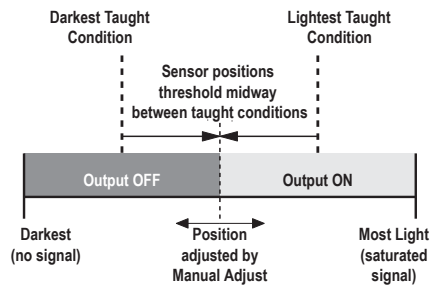

Figure 9. Dynamic TEACH (Light Operate shown)



Note: The sensor must be set to `tcH = dyn` to use the following instructions.



Note: To program the sensor using remote input, remote input must be enabled (`inp = set`)

1. Present the target.

Method	Action	Result
Push Button	Present the first target. The sensor-to-target distance must be within the sensor's range.	The target's value displays.
Remote Input		

2. Start the TEACH mode.

Method	Action	Result
Push Button	Press and hold TEACH for longer than 2 seconds.	<code>dyn</code> and <code>90</code> flash alternately on the display. The DYN indicator flashes.
Remote Input	No action required.	n/a

3. Teach the sensor.

Method	Action	Result
Push Button	Press TEACH to teach the target.	The sensor begins sampling target intensity information and <code>dyn</code> and <code>set</code> flash alternately on the display. The DYN indicator flashes.
Remote Input	Single-pulse the remote input. 	

4. Present the targets.

Method	Action	Result
Push Button	Present additional targets. The sensor-to-target distance must be within the sensor's range.	The sensor continues to sample target intensity information and <code>dyn</code> and <code>set</code> flash alternately on the display. The DYN indicator flashes.
Remote Input		

5. Teach the sensor.

Method	Action	Result
Push Button	Press TEACH to stop teaching the sensor.	The sensor sets the switching threshold and returns to Run mode.
Remote Input	Single-pulse the remote input. 	

Table 4: Expected TEACH Behavior for Dynamic TEACH

Condition	TEACH Result	Display
At least one taught condition is between the minimum and maximum signal level limits.	Sets the threshold between the two conditions.	The current NSS displays.
All conditions are darker than the minimum signal value limit.	Sets the threshold at the minimum level. Sets the sensor at the maximum detection condition.	top briefly displays, and then the current NSS displays.
All conditions are brighter than the maximum signal value limit.	Sets the threshold at the maximum level. Sets the sensor at the minimum detection condition.	bot briefly displays, and then the current NSS displays.
All conditions are at the same signal level. This is a Calibration Set.	Sets the threshold slightly below the two taught conditions.	cal briefly displays, and then the current NSS displays.

3.5.4 Window Set

Window set sets a sensing window using the window offset percentage. Use the **Per** menu to set the window offset percentage. The default is 20%.

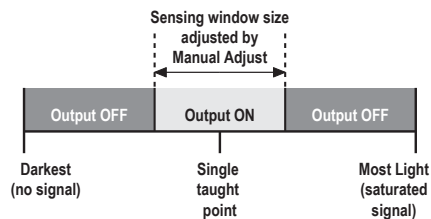

Figure 10. Window Set (Light Operate shown)



Note: The sensor must be set to **TECH = Win** to use the following instructions.



Note: To program the sensor using remote input, remote input must be enabled (**inp = Set**)

1. Present the target.

Method	Action	Result
Push Button Remote Input	Present the target. The sensor-to-target distance must be within the sensor's range.	The target's value displays.

2. Start the TEACH mode.

Method	Action	Result
Push Button	Press and hold TEACH for longer than 2 seconds.	Set and IPt flash alternately on the display. The WND indicator flashes.
Remote Input	No action required.	n/a

3. Teach the sensor.

Method	Action	Result
Push Button	Press TEACH to teach the target.	The sensor sets the window and returns to Run mode.
Remote Input	Single-pulse the remote input. 	Set flashes briefly on the display and the sensor returns to Run mode.

Table 5: Expected TEACH Behavior for Window Set

Condition	TEACH Result	Display
A valid condition is detected.	Sets a symmetric window around the taught condition. The threshold window is set by the Pct value.	The current NSS displays.
The taught condition is at a valid low signal level.	Sets a symmetric window around the taught condition, using the minimum offset value.	The achieved percent briefly displays, and then the current NSS displays.
The taught condition is less than the minimum detection range.	Sets a single threshold at the minimum level. Sets the sensor at the maximum detection condition.	LoP briefly displays, and then the current NSS displays.
The taught condition plus the offset is greater than the detection range.	Sets a single threshold at the maximum level. Sets the sensor at the minimum detection condition.	HiP briefly displays, and then the current NSS displays.

3.5.5 Light Set **Lt**

Light set sets a switching threshold a user-selectable percent offset below the presented condition. Use the **Pct** menu to set the offset percentage. The default is 20%.

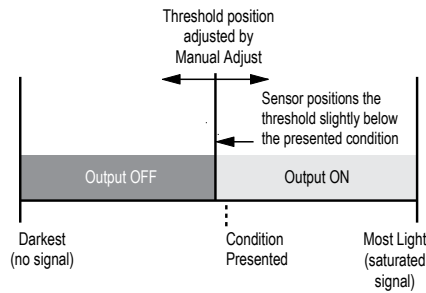

Figure 11. Light Set (Light Operate shown)



Note: The sensor must be set to **teH = Lt** to use the following instructions.



Note: To program the sensor using remote input, remote input must be enabled (**inp = Set**)

1. Present the target.

Method	Action	Result
Push Button	Present the target. The sensor-to-target distance must be within the sensor's range.	The target's value displays.
Remote Input		

2. Start the TEACH mode.

Method	Action	Result
Push Button	Press and hold TEACH for longer than 2 seconds.	Set and Lt flash alternately on the display. The DYN and WND indicators flash.
Remote Input	No action required.	n/a

3. Teach the sensor.

Method	Action	Result
Push Button	Press TEACH to teach the sensor.	The sensor sets the switching threshold and returns to Run mode.
Remote Input	Single-pulse the remote input. 	SET flashes briefly on the display and the sensor returns to Run mode.

Table 6: Expected TEACH Behavior for Light Set

Condition	TEACH Result	Display
A valid condition is detected.	Sets the threshold at a value less than the taught condition, as defined by the Pct value.	The current NSS displays.
The taught condition is at a low signal level.	Sets the threshold at a percentage greater than the value defined by the Pct value.	The percent offset needed with the presented target briefly displays, then the current NSS displays.
The taught condition is darker than the minimum signal value limit.	Sets the threshold at the minimum level. Sets the sensor at the maximum detection condition.	LOP briefly displays, and then the current NSS displays.
The taught condition is brighter than the maximum signal value limit.	Sets the threshold at the maximum level minus the Pct value.	The current NSS displays.

3.5.6 Dark Set

Dark set sets a switching threshold a user-selectable percent offset above the presented condition. Use the **Pct** menu to set the offset percentage. The default is 50%.

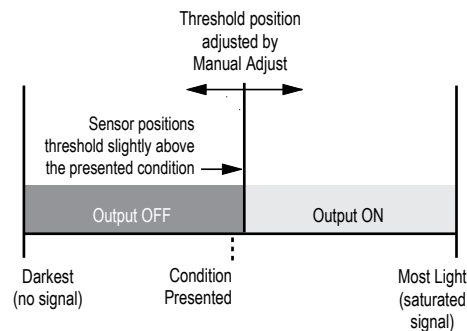

Figure 12. Dark Set (Light Operate shown)



Note: The sensor must be set to **tch = dr** to use the following instructions.



Note: To program the sensor using remote input, remote input must be enabled (**inp = SET**)

1. Present the target.

Method	Action	Result
Push Button	Present the target. The sensor-to-target distance must be within the sensor's range.	The target's value displays.
Remote Input		

2. Start the TEACH mode.

Method	Action	Result
Push Button	Press and hold TEACH for longer than 2 seconds.	SET and dr flash alternately on the display. The DYN and WND indicators flash.

Method	Action	Result
Remote Input	No action required.	n/a

3. Teach the sensor.

Method	Action	Result
Push Button	Press TEACH to teach the sensor.	The sensor sets the switching threshold and returns to Run mode.
Remote Input	Single-pulse the remote input. 	SET flashes briefly on the display and the sensor returns to Run mode.

Table 7: Expected TEACH Behavior for Dark Set

Condition	TEACH Result	Display
A valid condition is detected.	Sets the threshold at a value greater than the taught condition, as defined by the Pct value.	The current NSS displays.
The taught condition is a low signal level.	Sets the threshold at a percentage greater than the value defined by the Pct value.	The percent offset needed with the presented target briefly displays, then the current NSS displays.
The taught condition is darker than the minimum signal value limit.	Sets the threshold at the minimum level. Sets the sensor at the maximum detection condition.	LOP briefly displays, and then the current NSS displays.
The taught condition is brighter than the maximum signal value limit.	Sets the threshold at the maximum level. Sets the sensor at the minimum detection condition.	HOP briefly displays, and then the current NSS displays.

3.6 Sync Master/Slave

Two Q3X sensors may be used together in a single sensing application. To eliminate crosstalk between the two sensors, configure one sensor to be the master and one to be the slave. In this mode, the sensors alternate taking measurements and the response speed is 25 ms.

1. Configure the first sensor as the master; navigate: **MP > MSt** .
2. Configure the second sensor as the slave; navigate: **MP > SLV** .
3. Connect the gray (input) wires of the two sensors together.

3.7 Sensor Menu Map

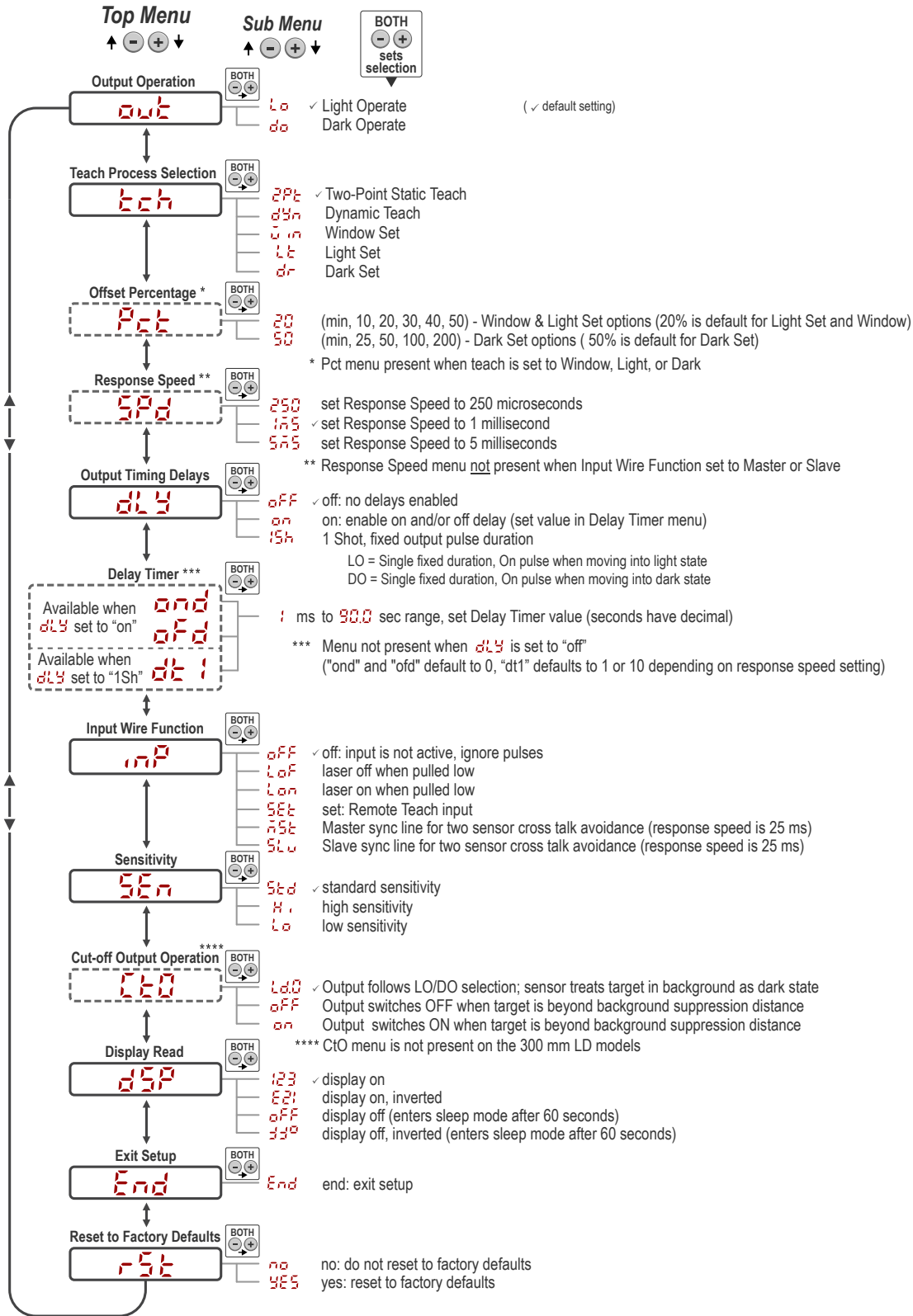

Figure 13. Setup Mode Menu Map

4 Specifications

Sensing Beam

Visible red Class 2 laser, 655 nm

Supply Voltage (Vcc)
10 to 30 V dc

Power and Current, exclusive of load

Supply Power: < 675 mW
Current **consumption**: < 28 mA at 24 V dc

Supply Protection Circuitry

Protected against reverse polarity and transient overvoltages

Repeatability

60 μs

Delay at Power Up

1 s

Maximum Torque

Side **mounting**: 1 N·m (9 in·lbs)
Nose **mounting**: 10 N·m (88 in·lbs)

Connector

5-pin M12 Euro-Style Integral Connector

Input Wire

Allowable Input Voltage Range: 0 to Vcc
Active Low (internal weak pullup—sinking current): Low State < 2.0 V at 1 mA max.

Output Configuration

Bipolar (1 PNP & 1 NPN) output

Output Rating

Discrete Output: 100 mA maximum (protected against continuous overload and short circuit)
Off-state Leakage Current: < 10 μA
NPN On-state **saturation** voltage: < 200 mV at 10 mA and < 1.0 V at 100 mA
PNP On-state **saturation** voltage: < 1 V at 10 mA and < 2.0 V at 100 mA

Ambient Light Immunity

> 5000 lux

Response Speed

User selectable:

- **250** —250 microseconds
- **1.75** —1 millisecond
- **5.75** —5 milliseconds

Operating Conditions

Temperature: -10 °C to +50 °C (+14 °F to +122 °F)
Humidity: 35% to 95% relative humidity

Environmental Rating

IEC IP67 per IEC60529
IEC IP68 per IEC60529
IEC IP69K per DIN40050-9

Sensing Range

Table 8: Sensing Range

Model	Contrast Sensing Range	Background Suppression Distance
Q3XTBLD-Q8	0 to 300 mm (11.81 in)	Not Applicable
Q3XTBLD50-Q8	0 to 50 mm (1.97 in)	60 mm (2.36 in)
Q3XTBLD100-Q8	0 to 100 mm (3.94 in)	120 mm (4.72 in)
Q3XTBLD150-Q8	0 to 150 mm (5.91 in)	190 mm (7.48 in)
Q3XTBLD200-Q8	0 to 200 mm (7.87 in)	280 mm (11.02 in)

Construction

Housing: Nickel-plated zinc die-cast
Side cover: Nickel-plated aluminum
Lens cover: Scratch-resistant PMMA acrylic
Lightpipes and display window: Polysulfone
Adjustment **buttons**: 316 stainless steel

Beam Spot Size

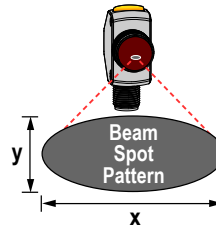

Table 9: Models LD, LD100, LD150, LD200

	Distance					
	20 mm	50 mm	100 mm	150 mm	200 mm	300 mm
X	5.9 mm	5.6 mm	5.1 mm	4.6 mm	4.1 mm	3.0 mm
Y	2.3 mm	2.1 mm	1.9 mm	1.6 mm	1.5 mm	1.2 mm

Table 10: Model LD50

	Distance	
	20 mm	50 mm
X	4.8 mm	3.4 mm
Y	2.0 mm	1.4 mm

Vibration

MIL-STD-202G, Method 201A (10 Hz to 60 Hz, 0.06 inch (1.52 mm) double amplitude, 2 hours each along X, Y and Z axes), with sensor operating

Shock

MIL-STD-202G, Method 213B, Condition I (100G 6x along X, Y and Z axes, 18 total shocks), with sensor operating

Storage Temperature

-25 °C to +75 °C (-13 °F to +167 °F)

Required Overcurrent **Protection**



WARNING: Electrical connections must be made by qualified personnel in accordance with local and national electrical codes and regulations.

Certifications



Overcurrent protection is required to be provided by end product application per the supplied table.
 Overcurrent protection may be provided with external fusing or via Current Limiting, Class 2 Power Supply.
 Supply wiring leads < 24 AWG shall not be spliced.
 For additional product support, go to www.bannerengineering.com.

Supply Wiring (AWG)	Required Overcurrent Protection (Amps)
20	5.0
22	3.0
24	2.0
26	1.0
28	0.8
30	0.5

4.1 Performance Curves

Performance is based on a 90% reflectance white test card.



Note: For high sensitivity, the excess gain increases by a factor of 1.5. For low sensitivity, the excess gain decreases by a factor of 0.75

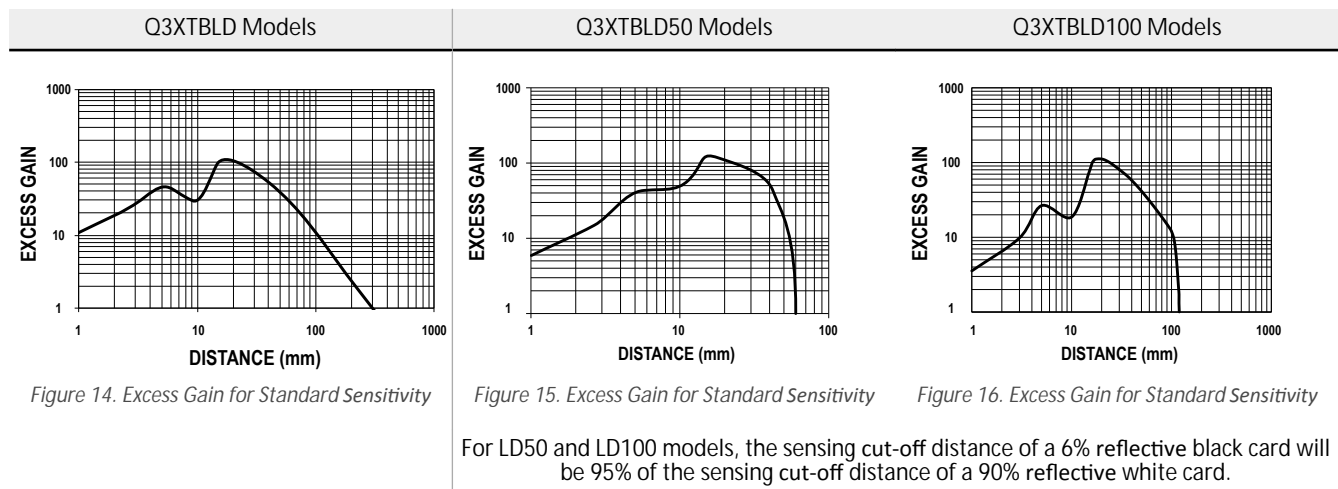

Q3XTBLD150 Models

Q3XTBLD200 Models

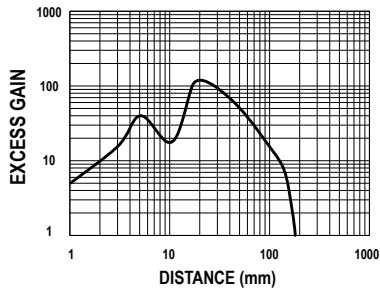

Figure 17. Excess Gain for Standard Sensitivity

For 150 mm models, the sensing cut-off distance for a 6% reflective black card will be 65% of the sensing cut-off distance of a 90% reflective white card.

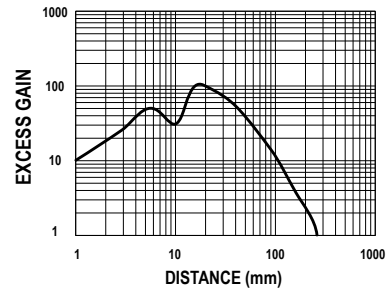
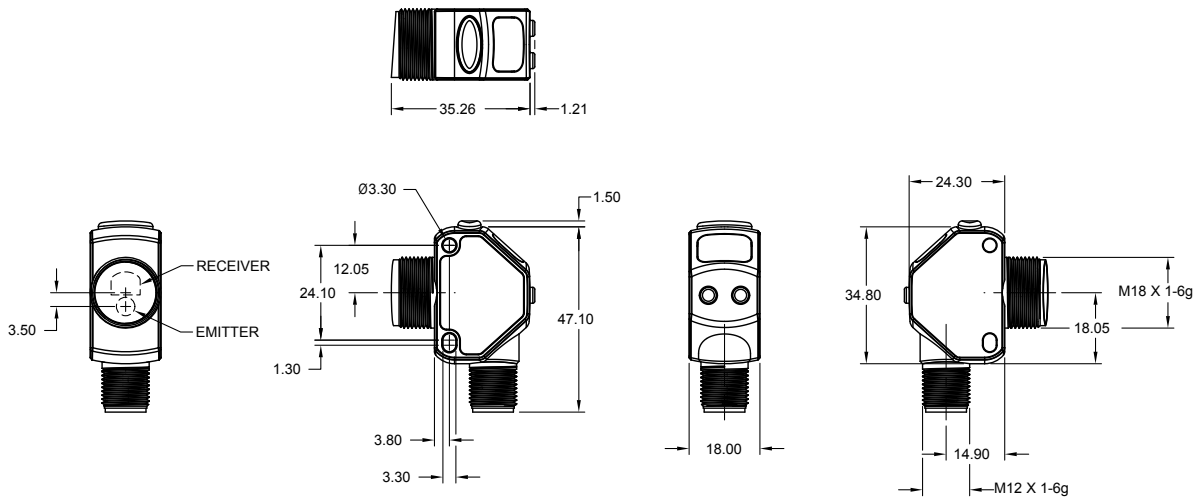

Figure 18. Excess Gain for Standard Sensitivity

For 200 mm models, the sensing cut-off distance for a 6% reflective black card will be 50% of the sensing cut-off distance of a 90% reflective white card.

4.2 Dimensions

All measurements are listed in millimeters [inches], unless noted otherwise.



5 Abbreviations

The following table describes the abbreviations used on the sensor display.

Abbreviation	Description
---	No light received (loss of signal)
999	The signal is saturated
1Sh	One shot
1St	First
1Pt	One point
2nd	Second
2Pt	Two-point static TEACH
bot	Bottom—The sensor is at minimum gain during a manual adjustment or after a TEACH
CAL	Calibration set
Cut	Cutoff—A target is detected in the background (models with background suppression only)
dLY	Output timing delays
do	Dark operate
dr	Dark set
dSP	Display read
dt 1	Delay timer
dyn	Dynamic TEACH
EGn	Excess gain
End	Exit to Run mode
Go	Go
H.1	High sensitivity
inp	Input wire function
Lo	Light operate or low sensitivity
Loc	Lock
LoF	Laser off
Lt	Light set
Min	Minimum
MSL	Master
oFd	Off delay
oNd	On delay
out	Output operation
Pct	Offset percentage

Abbreviation	Description
rSt	Reset to factory defaults
SEn	Sensitivity
SEt	Input wire = remote teach function or Set (used in the TEACH procedures)
Std	Standard sensitivity
SLv	Slave
SPd	Response speed
StP	Stop
tCH	Teach process selection
toP	Top—The sensor is at maximum gain during a manual adjust or after a TEACH
Win	Window set
ULc	Unlock

6 Troubleshooting

Table 11: Troubleshooting Codes

Code	Description	Resolution
---	No light received	For some applications, reposition the sensor or the target
999	The signal is saturated	For some applications, reposition the sensor or the target

Table 12: Error Codes

Code	Description	Resolution
Erc	Output short circuit	Check the wiring for an electrical short circuit
Erl	Laser fault	Contact Banner Engineering to resolve
The display is blank and the output indicator flashes	EEPROM or System Fault	Contact Banner Engineering to resolve

7 Accessories

7.1 Cordsets

All measurements are listed in millimeters, unless noted otherwise.

5-Pin Threaded M12/Euro-Style Cordsets—Single Ended				
Model	Length	Style	Dimensions	Pinout (Female)
MQDC1-501.5	0.50 m (1.5 ft)	Straight		<p>1 = Brown 2 = White 3 = Blue 4 = Black 5 = Gray</p>
MQDC1-506	1.83 m (6 ft)			
MQDC1-515	4.57 m (15 ft)			
MQDC1-530	9.14 m (30 ft)			
MQDC1-506RA	1.83 m (6 ft)	Right-Angle		
MQDC1-515RA	4.57 m (15 ft)			
MQDC1-530RA	9.14 m (30 ft)			

5-Pin Threaded M12/Euro-Style Cordsets—Washdown Stainless Steel				
Model	Length	Style	Dimensions	Pinout (Female)
MQDC-WDSS-0506	1.83 m (6 ft)	Straight		<p>1 = Brown 2 = White 3 = Blue 4 = Black 5 = Gray</p>
MQDC-WDSS-0515	4.57 m (15 ft)			
MQDC-WDSS-0530	9.14 m (30 ft)			

7.2 Brackets

All measurements are listed in millimeters, unless noted otherwise.

SMBQ4X..

- Swivel bracket with tilt and pan movement for precision adjustment
- Easy sensor mounting to extruded rail T-slots
- Metric and inch size bolts available
- Side mounting of some sensors with the 3 mm screws included with the sensor

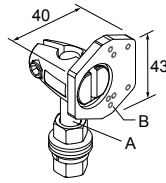

B = 7 × M3 × 0.5

Model	Bolt Thread (A)
SMBQ4XFA	3/8 - 16 × 2¼ in
SMBQ4XFAM10	M10 - 1.5 × 50
SMBQ4XFAM12	n/a; no bolt included. Mounts directly to 12 mm (½ in) rods

SMB18FA..

- Swivel bracket with tilt and pan movement for precision adjustment
- Easy sensor mounting to extruded rail T-slots
- Metric and inch size bolts available
- 18 mm sensor mounting hole

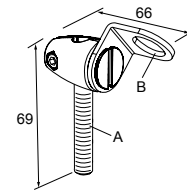

Hole size: B=Ø 18.1

Model	Bolt Thread (A)
SMB18FA	3/8 - 16 × 2 in
SMB18FAM10	M10 - 1.5 × 50
SMB18FAM12	n/a; no bolt included. Mounts directly to 12 mm (½ in) rods

SMB18A

- Right-angle mounting bracket with a curved slot for versatile orientation
- 12-ga. stainless steel
- 18 mm sensor mounting hole
- Clearance for M4 (#8) hardware

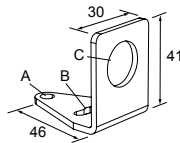

Hole center spacing: A to B = 24.2

Hole size: A = Ø 4.6, B = 17.0 × 4.6, C = Ø 18.5

8 Contact Us

Corporate Headquarters

Address:
Banner Engineering Corporate
9714 Tenth Avenue North
Minneapolis, Minnesota 55441, USA

Phone: +1 763 544 3164
Website: www.bannerengineering.com

Europe

Address:
Banner Engineering EMEA
Park Lane Culliganlaan 2F
Diegem B-1831, Belgium

Phone: +32 (0)2 456 0780
Website: www.bannerengineering.com/eu
Email: mail@bannerengineering.com

Turkey

Address:
Banner Engineering Turkey
Barbaros Mah. Uphill Court Towers A Blok D:49
34746 Batı Ataşehir İstanbul Türkiye

Phone: +90 216 688 8282
Website: www.bannerengineering.com.tr
Email: turkey@bannerengineering.com.tr

India

Address:
Banner Engineering India Pune Head Quarters
Office No. 1001, 10th Floor Sai Capital, Opp. ICC Senapati Bapat Road
Pune 411016, India

Phone: +91 (0) 206 640 5624
Website: www.bannerengineering.co.in
Email: salesindia@bannerengineering.com

Mexico

Address:
Banner Engineering de Mexico Monterrey Head Office
Edificio VAO Av. David Alfaro Siqueiros No.103 Col. Valle Oriente C.P.66269
San Pedro Garza Garcia, Nuevo Leon, Mexico

Phone: +52 81 8363 2714 or 01 800 BANNERE (toll free)
Website: www.bannerengineering.com.mx
Email: mexico@bannerengineering.com

Brazil

Address:
Banner do Brasil
Rua Barão de Teffé nº 1000, sala 54
Campos Elíseos, Jundiaí - SP, CEP.: 13208-761, Brasil

Phone: +1 763 544 3164
Website: www.bannerengineering.com.br
Email: brasil@bannerengineering.com

China

Address:
Banner Engineering Shanghai Rep Office
Xinlian Scientific Research Building Level 12, Building 2
1535 Hongmei Road, Shanghai 200233, China

Phone: +86 212 422 6888
Website: www.bannerengineering.com.cn
Email: sensors@bannerengineering.com.cn

Japan

Address:
Banner Engineering Japan
Cent-Urban Building 305 3-23-15 Nishi-Nakajima Yodogawa-Ku
Osaka 532-0011, Japan

Phone: +81 (0)6 6309 0411
Website: www.bannerengineering.co.jp
Email: mail@bannerengineering.co.jp

Taiwan

Address:
Banner Engineering Taiwan
8F-2, No. 308 Section 1, Neihu Road
Taipei 114, Taiwan

Phone: +886 (0)2 8751 9966
Website: www.bannerengineering.com.tw
Email: info@bannerengineering.com.tw

9 Banner Engineering Corp Limited Warranty

Banner Engineering Corp. warrants its products to be free from defects in material and workmanship for one year following the date of shipment. Banner Engineering Corp. will repair or replace, free of charge, any product of its manufacture which, at the time it is returned to the factory, is found to have been defective during the warranty period. This warranty does not cover damage or liability for misuse, abuse, or the improper application or installation of the Banner product.

THIS LIMITED WARRANTY IS EXCLUSIVE AND IN LIEU OF ALL OTHER WARRANTIES WHETHER EXPRESS OR IMPLIED (INCLUDING, WITHOUT LIMITATION, ANY WARRANTY OF MERCHANTABILITY OR FITNESS FOR A PARTICULAR PURPOSE), AND WHETHER ARISING UNDER COURSE OF PERFORMANCE, COURSE OF DEALING OR TRADE USAGE.

This Warranty is exclusive and limited to repair or, at the discretion of Banner Engineering Corp., replacement. IN NO EVENT SHALL BANNER ENGINEERING CORP. BE LIABLE TO BUYER OR ANY OTHER PERSON OR ENTITY FOR ANY EXTRA COSTS, EXPENSES, LOSSES, LOSS OF PROFITS, OR ANY INCIDENTAL, CONSEQUENTIAL OR SPECIAL DAMAGES RESULTING FROM ANY PRODUCT DEFECT OR FROM THE USE OR INABILITY TO USE THE PRODUCT, WHETHER ARISING IN CONTRACT OR WARRANTY, STATUTE, TORT, STRICT LIABILITY, NEGLIGENCE, OR OTHERWISE.

Banner Engineering Corp. reserves the right to change, modify or improve the design of the product without assuming any obligations or liabilities relating to any product previously manufactured by Banner Engineering Corp. Any misuse, abuse, or improper application or installation of this product or use of the product for personal protection applications when the product is identified as not intended for such purposes will void the product warranty. Any modifications to this product without prior express approval by Banner Engineering Corp will void the product warranties. All specifications published in this document are subject to change; Banner reserves the right to modify product specifications or update documentation at any time. Specifications and product information in English supersede that which is provided in any other language. For the most recent version of any documentation, refer to: www.bannerengineering.com.