

Monsoon 3-in-1

Part No:
MA173.A.LBI.001

Description:

3-in 1 GNSS, 5G/4GMIMO
Low Profile Permanent Mount Antenna

Features:

2*5G/4G MIMO Antenna
1*Active GNSS Antenna - GPS L1 and GLONASS L1
Permanent (Screwmount) Mounting
IP67 Rated Enclosure
Dimensions: 204*69*31 mm
5G/4G MIMO: 3M CFD200 Cable and SMA(M)ST Connector
GNSS: 3M RG-174 Cable and SMA(M)ST Connector
Cables & Connectors Customizable
Dimensions: 204*69*31 mm
REACH & RoHS Compliant



1. Introduction	3
2. Specifications	4
3. Antenna Characteristics	9
4. Radiation Patterns	18
5. Mechanical Drawing	37
6. Packaging	38
<hr/>	
Changelog	39

Taoglas makes no warranties based on the accuracy or completeness of the contents of this document and reserves the right to make changes to specifications and product descriptions at any time without notice. Taoglas reserves all rights to this document and the information contained herein. Reproduction, use or disclosure to third parties without express permission is strictly prohibited. Copyright © Taoglas Ltd.



1. Introduction



The Monsoon MA173 antenna is a low-profile combination antenna. It integrates high-performing 5G/4G MIMO antennas with an active GNSS antenna that supports both GPS L1 and GLONASS L1 bands. All antennas are enclosed in a robust, IP67 waterproof enclosure designed for use in the most challenging of environments.

Typical applications include:

- HD Video over LTE
- Intelligent Transport Systems
- Internet of Things (IoT market)
- High-Definition Video Broadcast Systems
- Wireless LTE M2M Devices
- Digital Signage
- First Responder and Emergency Services

The Monsoon cellular MIMO antennas are designed for high efficiency, even without a ground plane. 5G/4G applications demand high speed data uplink and downlink, and the high efficiency and gain characteristics exhibited by this antenna help to achieve the required signal to noise ratio and throughput to solve these challenges. Low loss cables are used to keep efficiency high over longer cables lengths.

The GNSS antenna has been optimized to work on both GPS and GLONASS bands. Dual GPS/GLONASS systems can accelerate time to first fix, especially in challenging environments such as urban canyons or any environment where a large portion of the sky is blocked. A front-end SAW filter protects the GNSS antenna's LNA from potentially damaging out-of-band wireless transmissions, ensuring that it can be used in environments where these signals might be encountered.

All cable and connectors are customizable, contact your regional Taoglas sales office for customization and additional support.

2. Specifications

GNSS Electrical			
Frequency	GPS L1: 1575.42 MHz ± 1.023 MHz GLONASS L1: 1602 MHz ± 1.023 MHz		
Bandwidth - Return Loss <-10 dB	6 MHz min		
Return loss (GPS L1 GLONASS L1)	< -10 dB		
Passive Gain at Zenith (GPS L1 and GLONASS L1)	+1.0 dBic typ.		
Polarization	RHCP		
Impedance	50 Ω		
LNA Out-band Attenuation	fo = 1575.42MHz fo ± 30 MHz 5dB Min. fo ± 50 MHz 20dB Min. fo ± 100 MHz 25dB Min.		
Input Voltage	Min:1.8V	Typ. 3.0V	Max: 5.5V
Total Gain @ Zenith	25dBic	30dBic	32dBic
Current Consumption	6mA	12mA	30mA
Noise Figure	2.7dB	3.0dB	3.7dB

5G/4G MIMO1 Antenna									
Band	Frequency (MHz)		Efficiency (%)	Average Gain (dB)	Peak Gain (dBi)	Impedance	Max Input Power	Polarization	Radiation Pattern
4G/3G Band 12,13,14,17,28,29	698~824	Free space	34	-4.64	0.79	50 Ω	10W	Vertical	Omni-Directional
		On 30x30cm Ground Plane	42	-3.91	1.05				
4G/3G/NB-IoT/Cat M Band 5,8,18,19,20,26,27	824~960	Free space	48	-3.26	2.74				
		On 30x30cm Ground Plane	43	-3.74	2.21				
5GNR/4G Band 21,32,74,75,76	1427~1518	Free space	53	-2.74	2.66				
		On 30x30cm Ground Plane	48	-3.18	4.49				
4G/3G Band 1,2,3,4,9,23,25,35,39,66	1710~2200	Free space	60	-2.20	3.83				
		On 30x30cm Ground Plane	58	-2.40	5.25				
4G/3G Band 7,30,38,40,41	2300~2690	Free space	52	-2.86	4.04				
		On 30x30cm Ground Plane	49	-3.14	5.86				
5GNR/4G Band 22,42,48,77,78,79	3300~5000	Free space	46	-3.53	4.12				
		On 30x30cm Ground Plane	42	-4.09	6.39				
LTE5200/ Wi-Fi 5800	5150~5925	Free space	13	-8.97	-0.01				
		On 30x30cm Ground Plane	9	-10.72	0.65				

5G/4G MIMO2 Antenna

Band	Frequency (MHz)		Efficiency (%)	Average Gain (dB)	Peak Gain (dBi)	Impedance	Max Input Power	Polarization	Radiation Pattern
4G/3G Band 12,13,14,17,28,29	698~824	Free space	34	-4.71	1.11	50 Ω	10W	Vertical	Omni-Directional
		On 30x30cm Ground Plane	43	-3.86	1.00				
4G/3G/NB-IoT/Cat M Band 5,8,18,19,20,26,27	824~960	Free space	44	-3.63	2.74				
		On 30x30cm Ground Plane	39	-4.15	1.94				
5GNR/4G Band 21,32,74,75,76	1427~1518	Free space	52	-2.85	2.48				
		On 30x30cm Ground Plane	49	-3.09	4.35				
4G/3G Band 1,2,3,4,9,23,25,35,39,66	1710~2200	Free space	63	-1.98	4.16				
		On 30x30cm Ground Plane	61	-2.13	5.23				
4G/3G Band 7,30,38,40,41	2300~2690	Free space	53	-2.77	4.07				
		On 30x30cm Ground Plane	51	-2.94	6.03				
5GNR/4G Band 22,42,48,77,78,79	3300~5000	Free space	54	-2.79	4.33				
		On 30x30cm Ground Plane	50	-3.18	6.41				
LTE5200/ Wi-Fi 5800	5150~5925	Free space	22	-6.63	2.42				
		On 30x30cm Ground Plane	21	-7.10	5.65				

Mechanical	
Dimensions	203.95 x 68.96 x 30.95 mm
Cable	LTE: 3000mm CFD200 Wi-Fi: 3000mm CFD200 GNSS: 3000mm RG174
Connector	LTE: SMA(M) Wi-Fi: RP-SMA(M) GNSS: SMA(M)
Casing	PC+ABS
Adhesive	3M 9448HK + CR4305
Sealant	Rubber Stopper
Weight	550 g
Environmental	
Protection	IP67
Corrosion	5% NaCl for 96hrs - Nickel plated steel base and thread
Temperature Range	-40°C to +85°C
Thermal Shock	100 cycles -40°C to +85°C
Humidity	Non-condensing 65°C 95% RH
Shock (Drop Test)	1m drop on concrete 6 axes
Recommended Mounting Torque	24.5N·m
Maximum Mounting Torque	29.5N·m

5G/4G Bands			
Band Number	5G NR / FR1 / LTE / LTE-Advanced / WCDMA / HSPA / HSPA+ / TD-SCDMA		
	Uplink	Downlink	Covered
1	UL: 1920 to 1980	DL: 2110 to 2170	✓
2	UL: 1850 to 1910	DL: 1930 to 1990	✓
3	UL: 1710 to 1785	DL: 1805 to 1880	✓
4	UL: 1710 to 1755	DL: 2110 to 2155	✓
5	UL: 824 to 849	DL: 869 to 894	✓
7	UL: 2500 to 2570	DL: 2620 to 2690	✓
8	UL: 880 to 915	DL: 925 to 960	✓
9	UL: 1749.9 to 1784.9	DL: 1844.9 to 1879.9	✓
11	UL: 1427.9 to 1447.9	DL: 1475.9 to 1495.9	✓
12	UL: 699 to 716	DL: 729 to 746	✓
13	UL: 777 to 787	DL: 746 to 756	✓
14	UL: 788 to 798	DL: 758 to 768	✓
17	UL: 704 to 716	DL: 734 to 746	✓
18	UL: 815 to 830	DL: 860 to 875	✓
19	UL: 830 to 845	DL: 875 to 890	✓
20	UL: 832 to 862	DL: 791 to 821	✓
21	UL: 1447.9 to 1462.9	DL: 1495.9 to 1510.9	✓
22	UL: 3410 to 3490	DL: 3510 to 3590	✓
23	UL: 2000 to 2020	DL: 2180 to 2200	✓
24	UL: 1625.5 to 1660.5	DL: 1525 to 1559	✓
25	UL: 1850 to 1915	DL: 1930 to 1995	✓
26	UL: 814 to 849	DL: 859 to 894	✓
27	UL: 807 to 824	DL: 852 to 869	✓
28	UL: 703 to 748	DL: 758 to 803	✓
29	UL: -	DL: 717 to 728	✓
30	UL: 2305 to 2315	DL: 2350 to 2360	✓
31	UL: 452.5 to 457.5	DL: 462.5 to 467.5	✗
32	UL: -	DL: 1452 - 1496	✓
35		1850 to 1910	✓
38		2570 to 2620	✓
39		1880 to 1920	✓
40		2300 to 2400	✓
41		2496 to 2690	✓
42		3400 to 3600	✓
43		3600 to 3800	✓
48		3550 to 3700	✓
66	UL: 1710-1780	DL: 2110-2200	✓
71		617 to 698	✓
74/75/76		1427 to 1518	✓
78		3300 to 3800	✓
79		4400 to 5000	✓
85	698-716	728-746	✓

3. Antenna Characteristics

3.1 Return Loss – 5G/4G MIMO1 and MIMO2 (Free space)

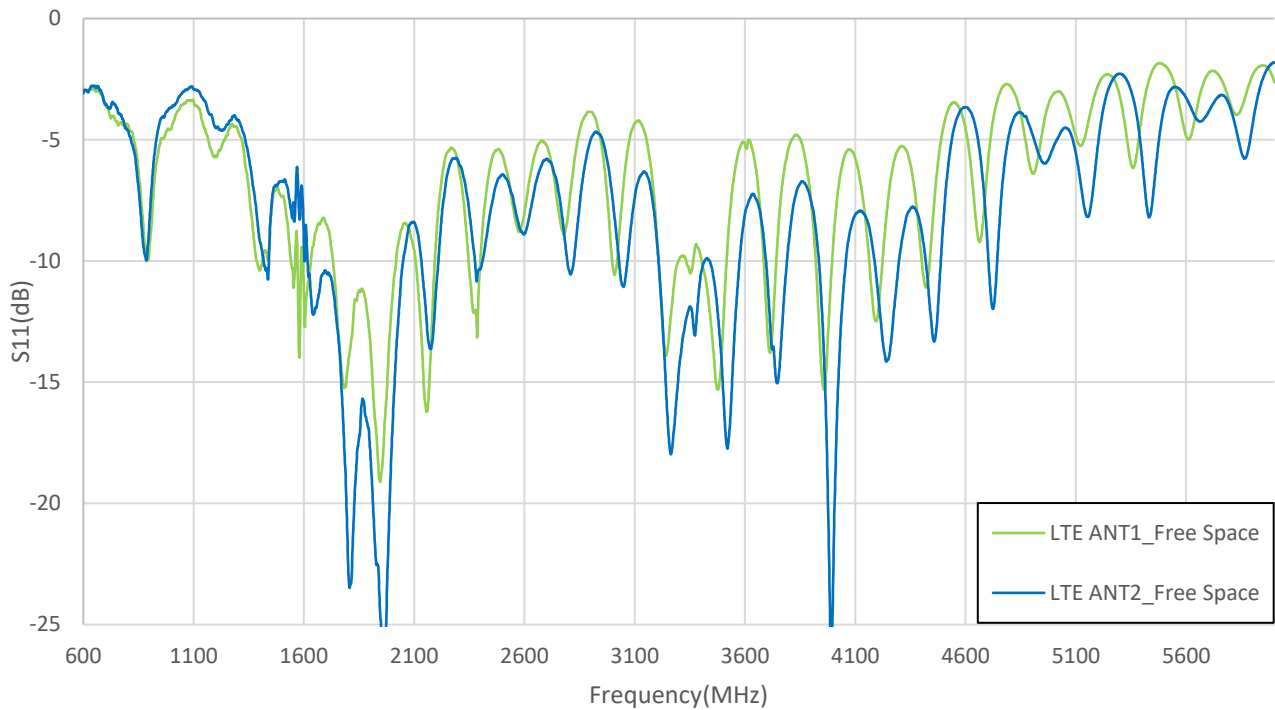

3.2 Return Loss – 5G/4G MIMO1 and MIMO2 (30cm SQ Ground plane)

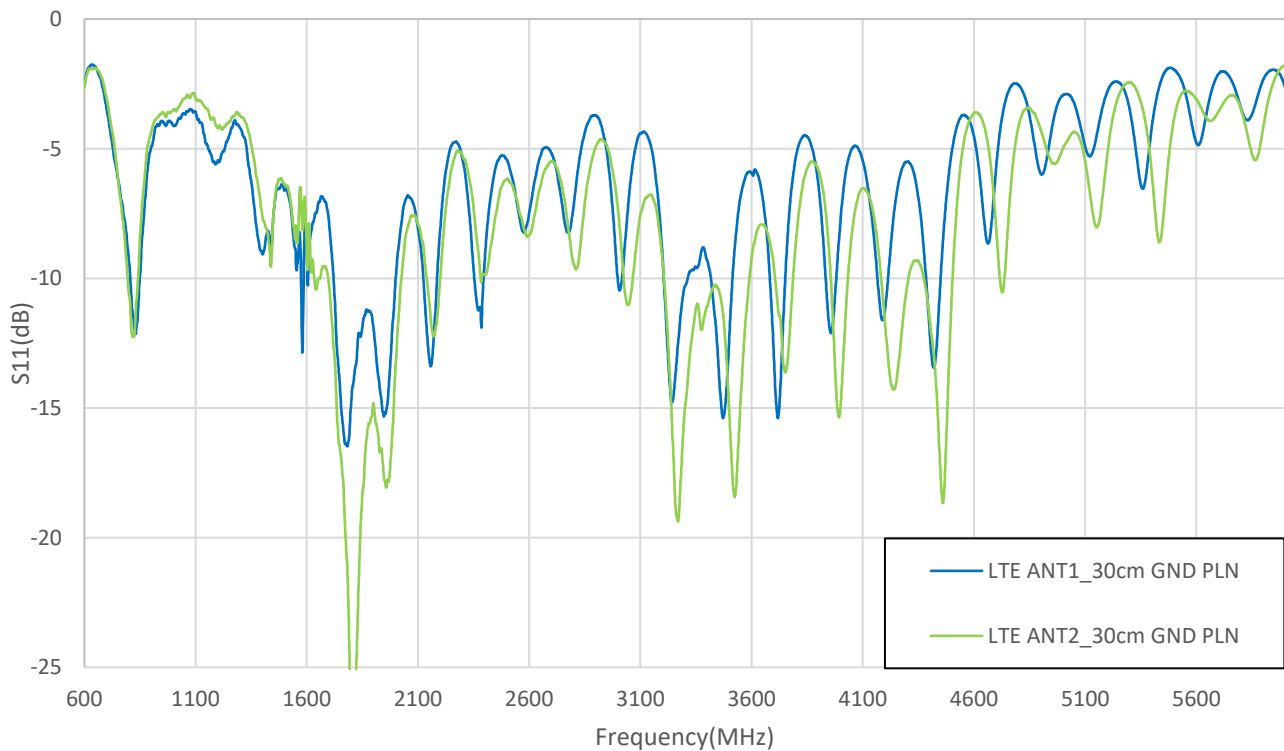

3.3 Efficiency – 5G/4G MIMO1 and MIMO2 (Free space)

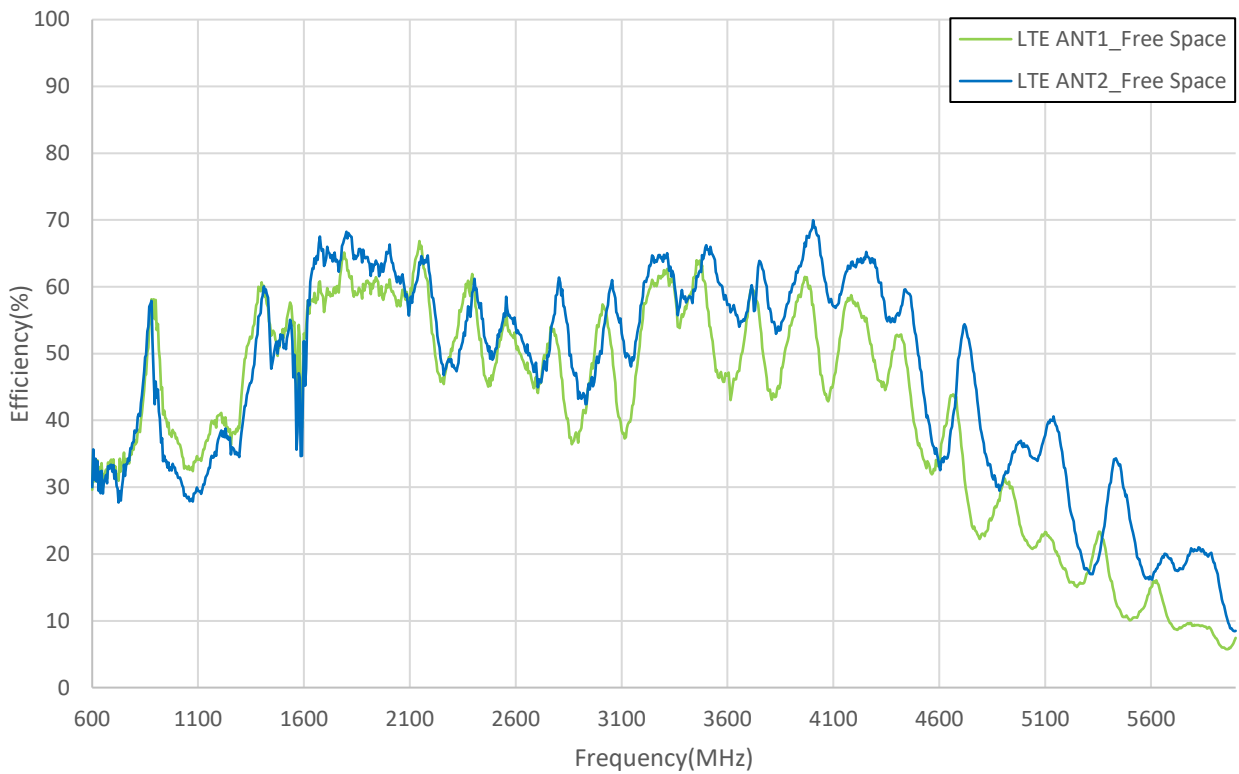

3.4 Efficiency – 5G/4G MIMO1 and MIMO2 (30cm SQ Ground plane)

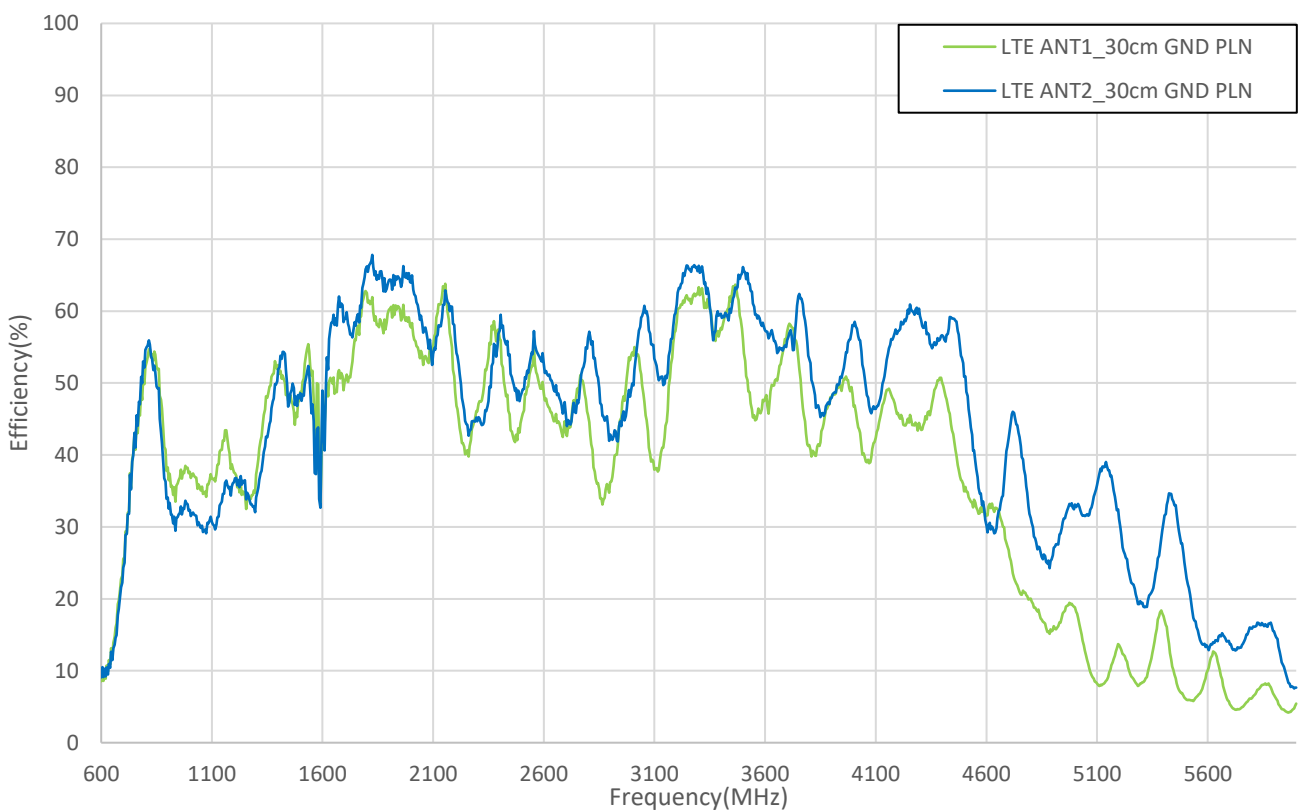

3.5 Peak Gain – 5G/4G MIMO1 and MIMO2 (Free space)

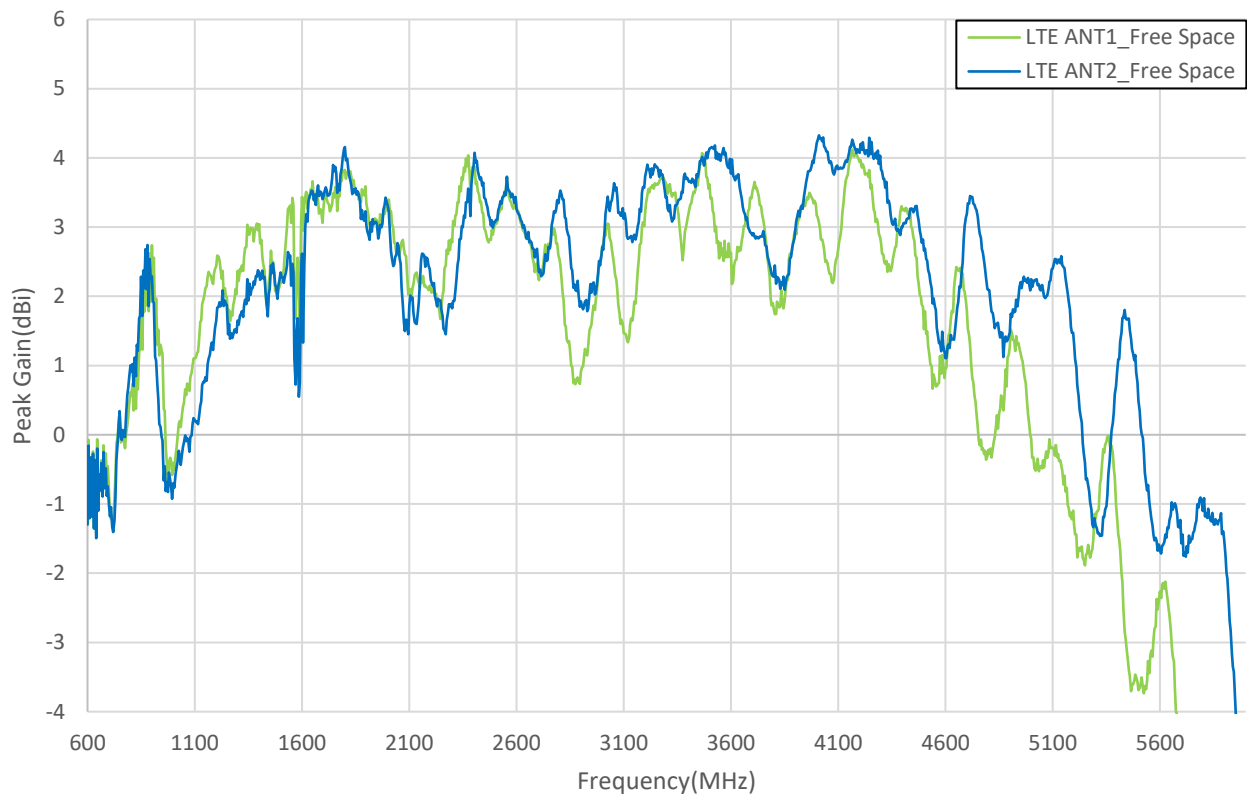

3.6 Peak Gain – 5G/4G MIMO1 and MIMO2 (30cm SQ Ground plane)

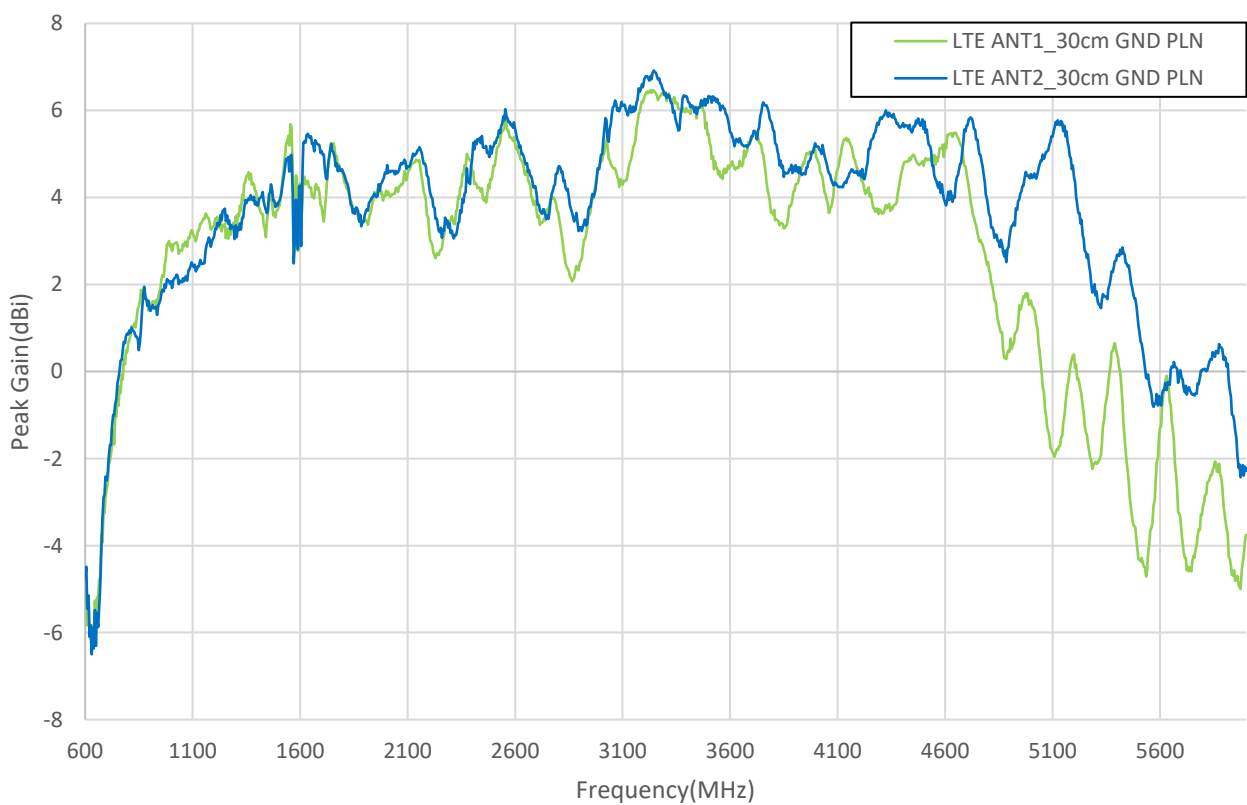

3.7 Average Gain – 5G/4G MIMO1 and MIMO2 (Free space)

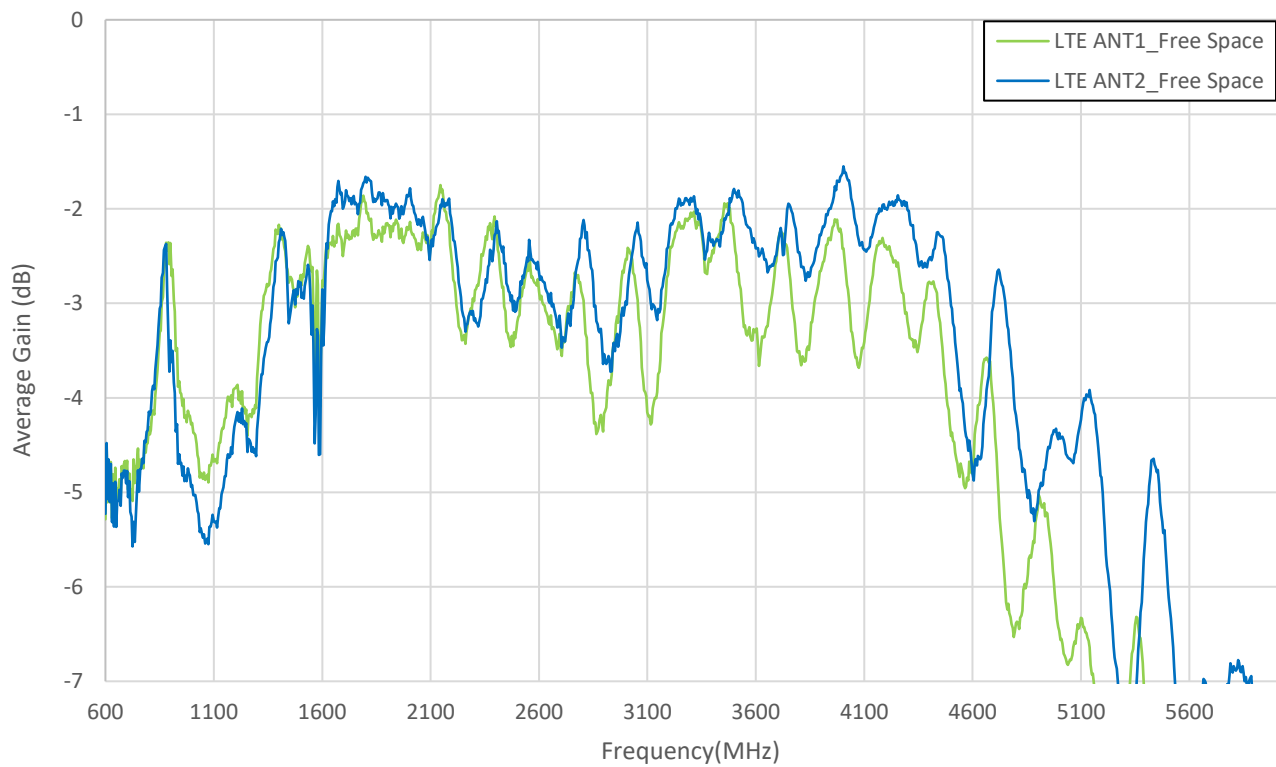

3.8 Average Gain – 5G/4G MIMO1 and MIMO2 (30cm SQ Ground plane)

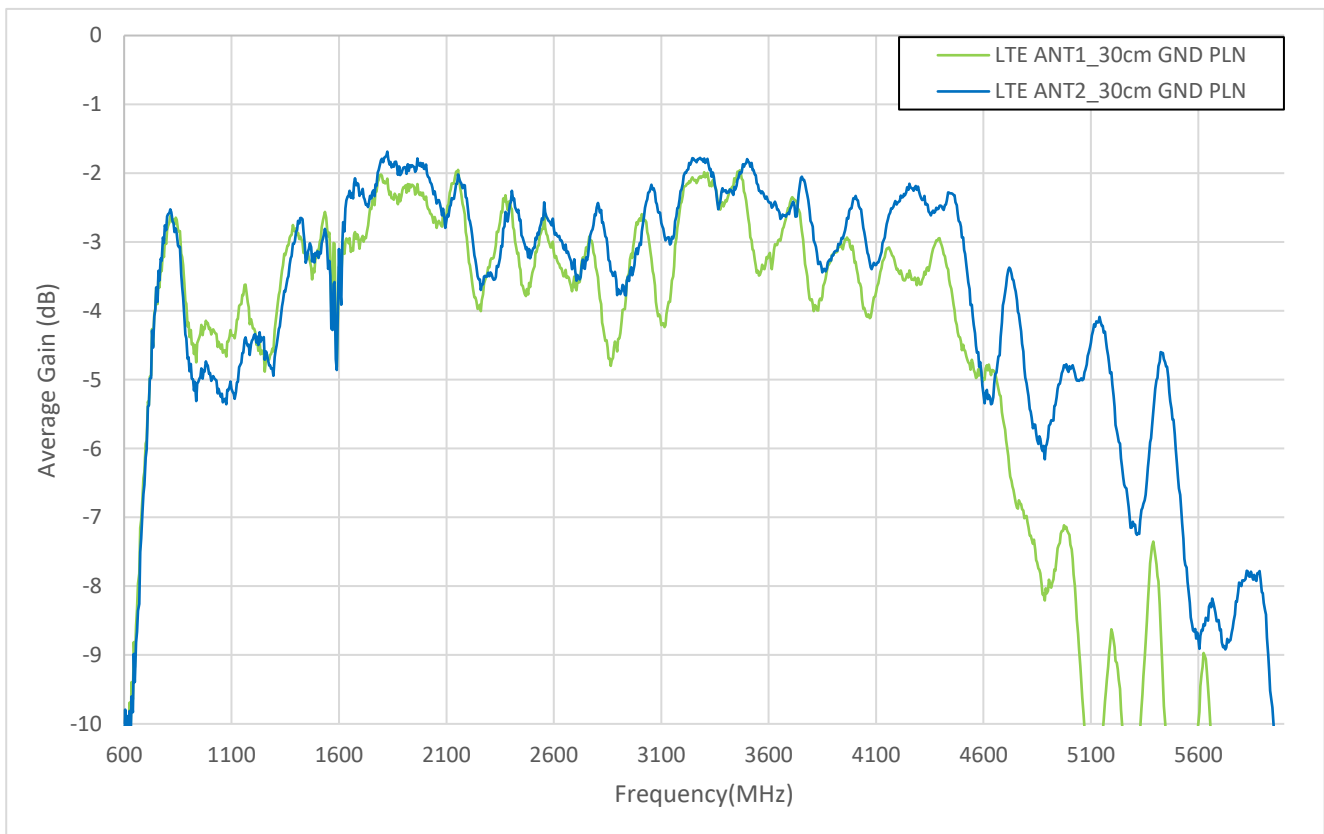

3.9 GNSS Antenna – Block Diagram (Active Antenna)

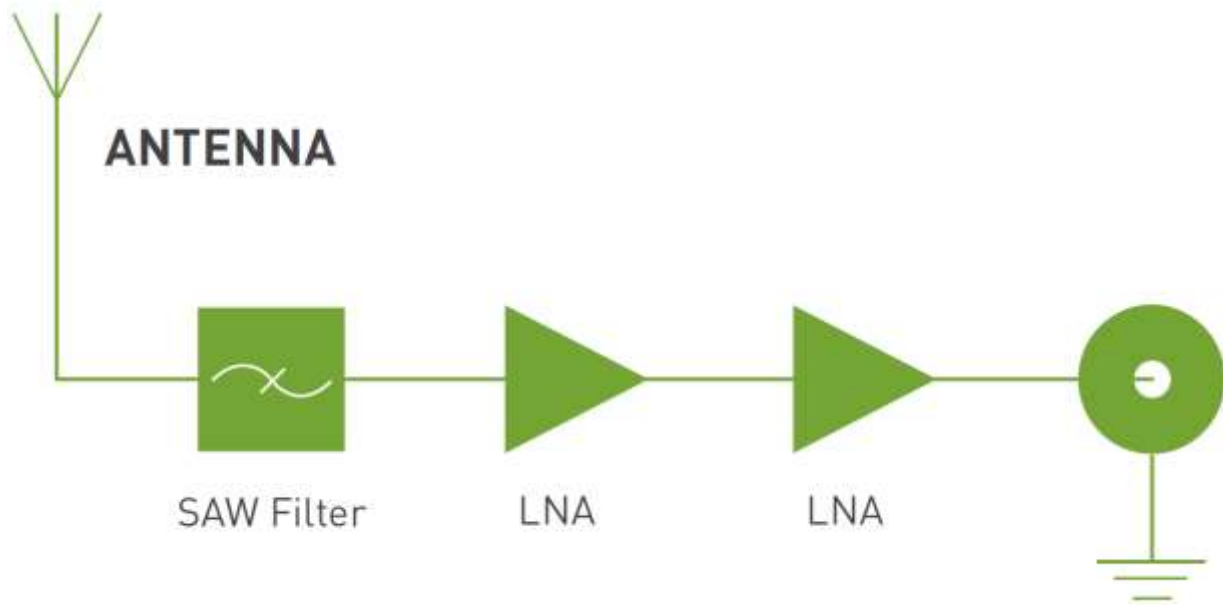

3.10 GNSS Antenna – Return Loss

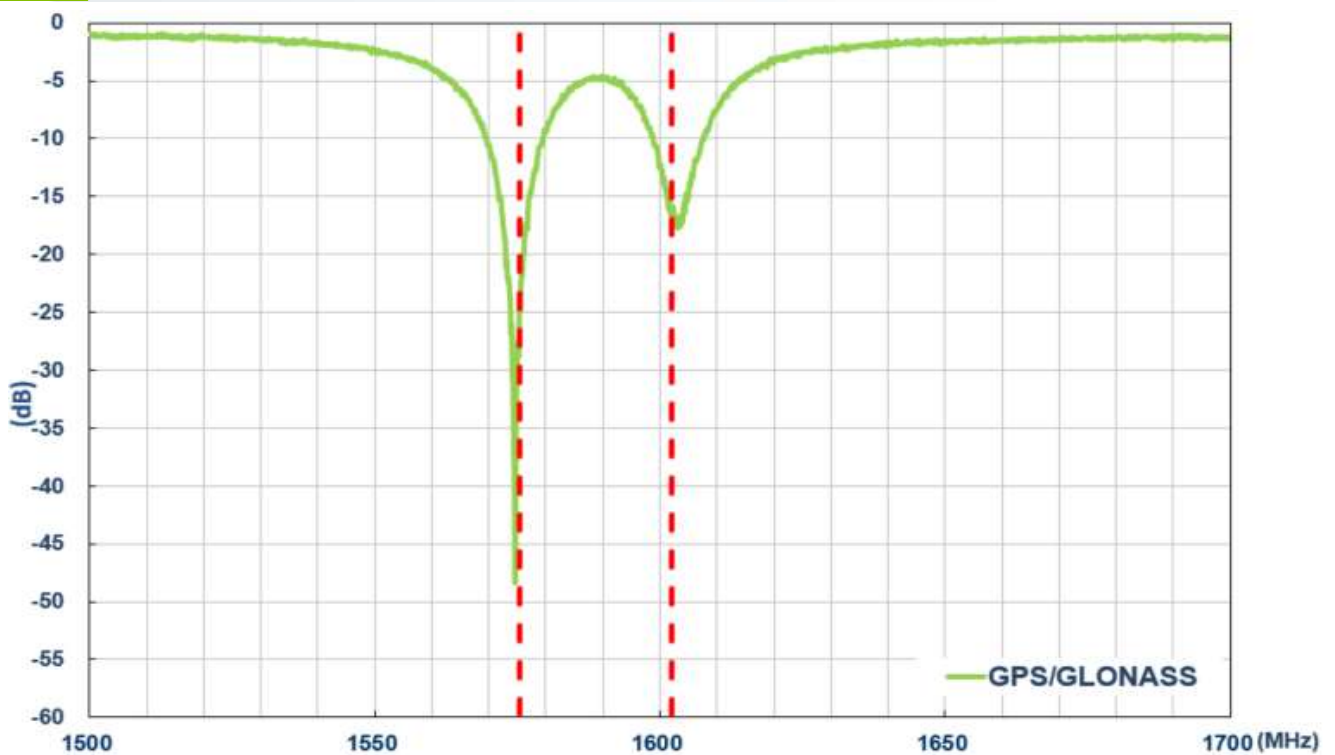

3.11 GNSS Antenna – Efficiency (Passive Measurement)

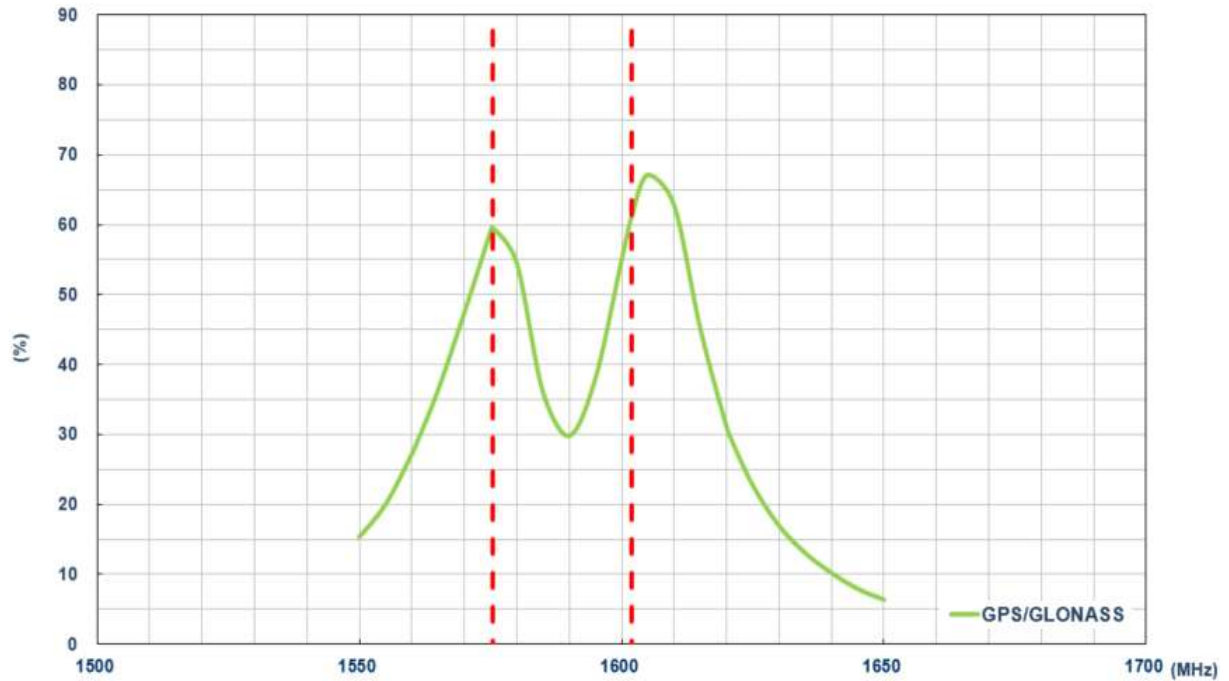

3.12 GNSS Antenna – Average Gain (Passive Measurement)

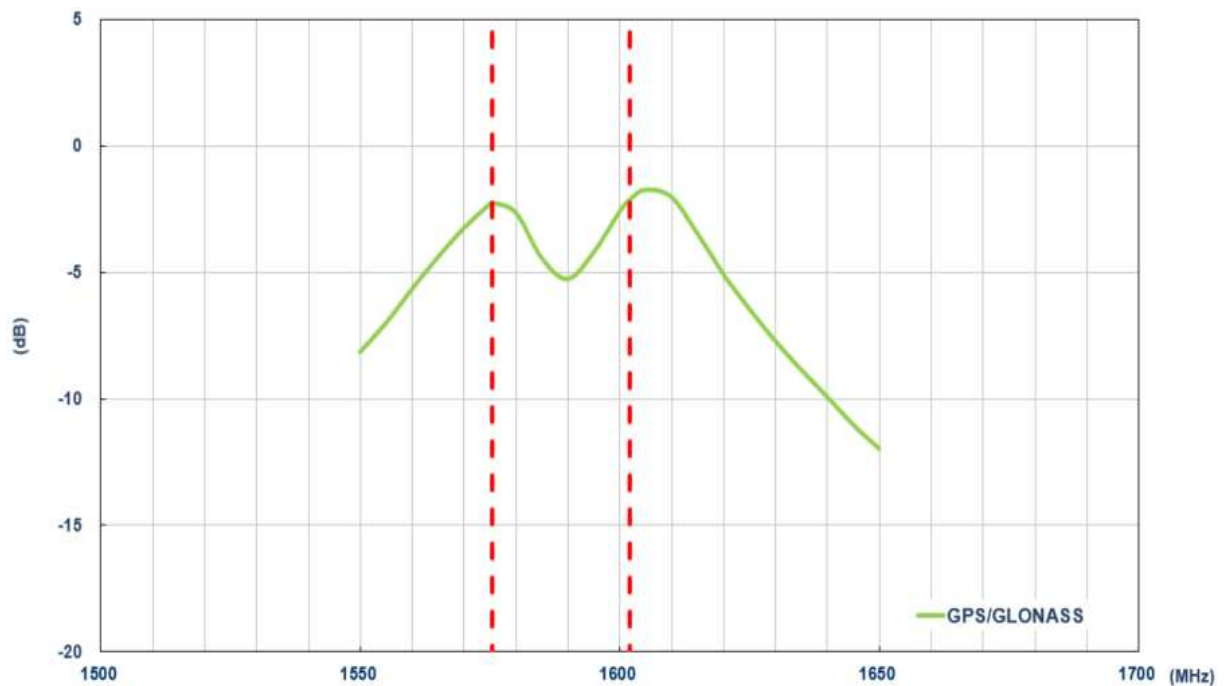

3.13 GNSS Antenna – Peak Gain (Passive Measurement)

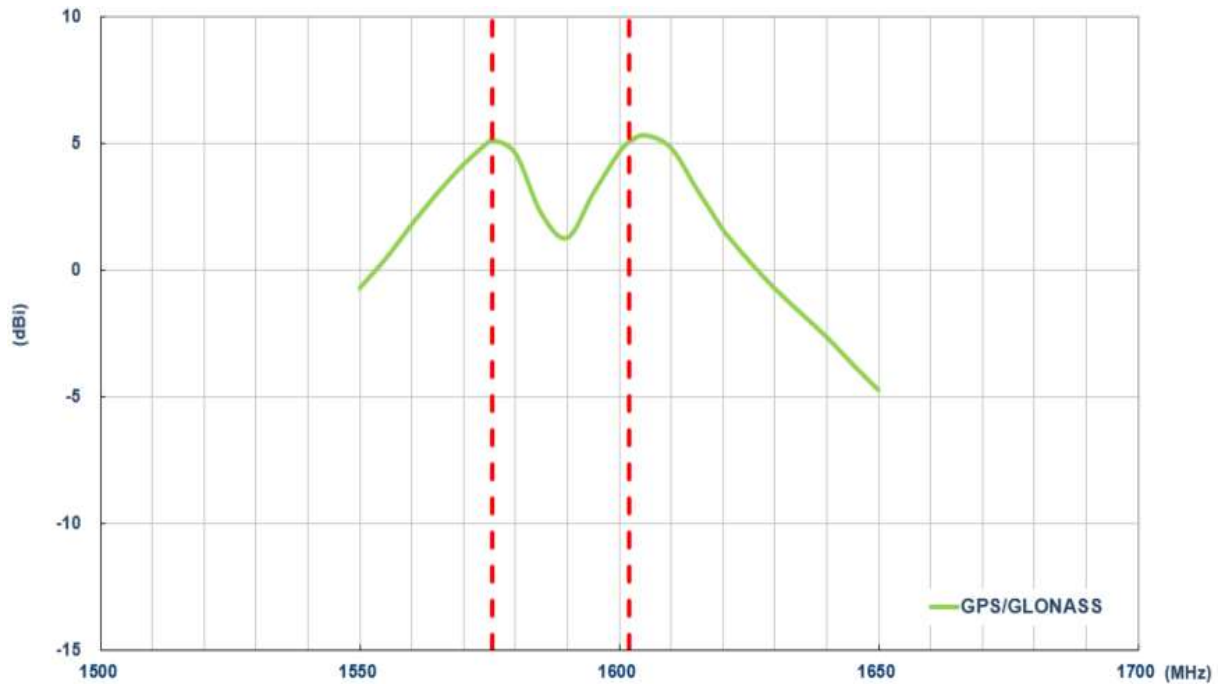

3.14 GNSS Antenna – Axial Ratio (Zenith is at 0°)

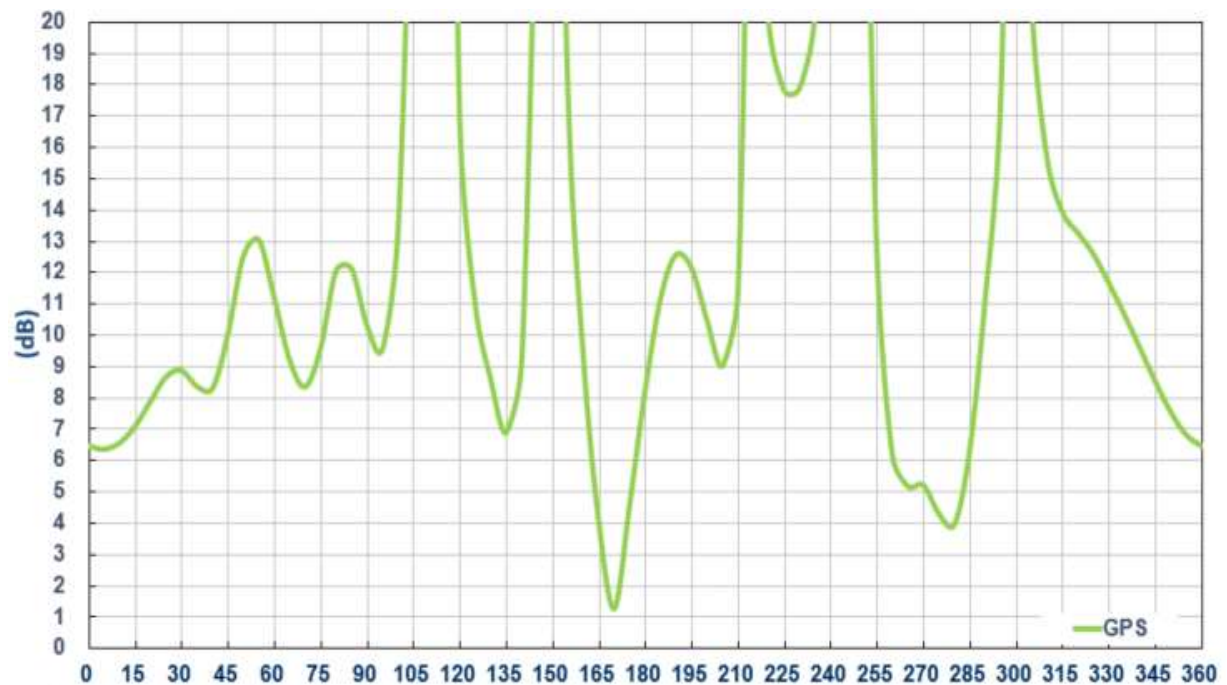

Axial Ratio at GPS L1 (1575.42MHz)

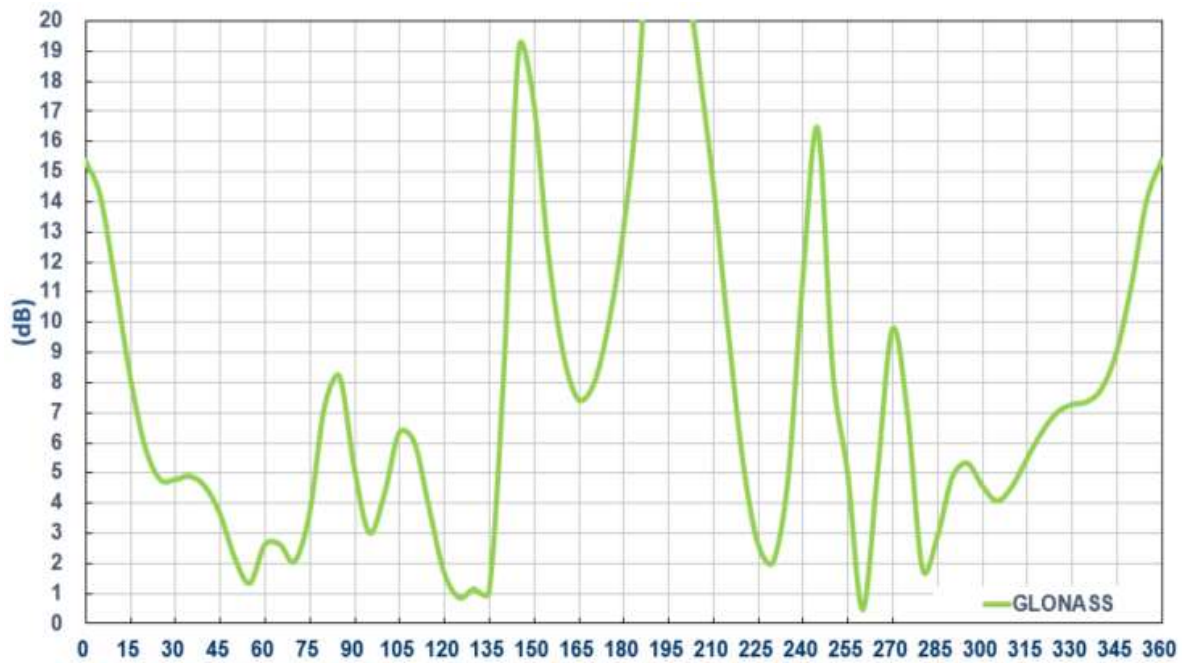

Axial Ratio at GLONASS L1 (1602MHz)

3.14 GNSS Antenna – Active Measurements



LNA Gain @ 3.0V

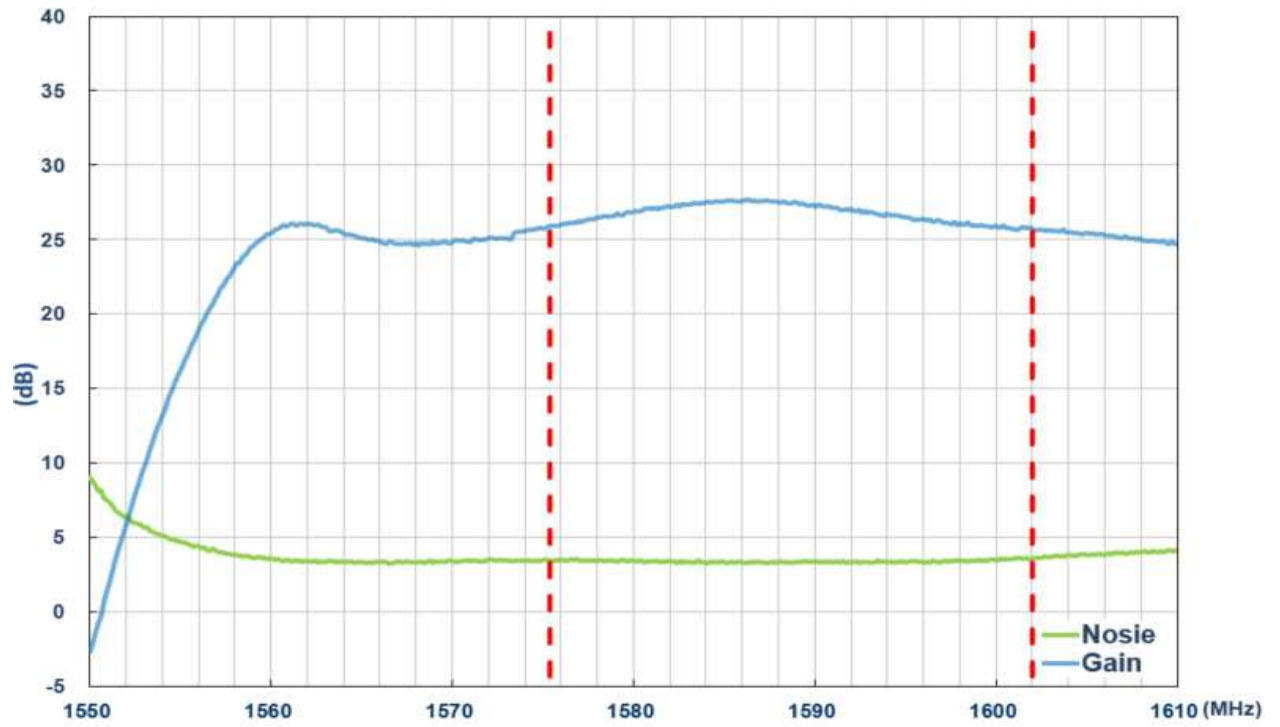

LNA Gain and Noise Figure @ 3.0V

4. Radiation Patterns

4.1 Test Setup



Free space



On 30*30cm GND

4.2 2D & 3D Radiation Patterns – Free space

617MHz (MIMO1)

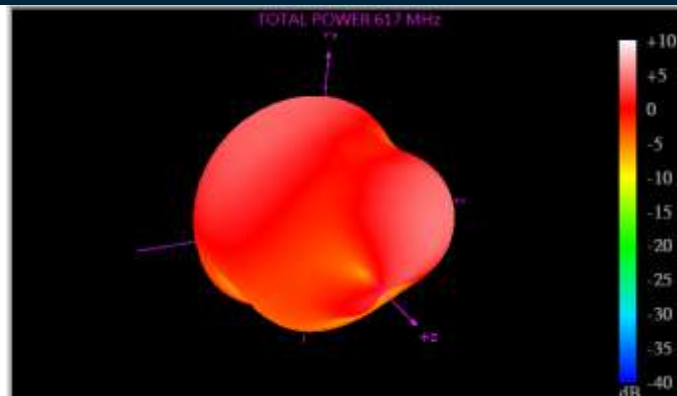

XY Plane

XZ Plane

YZ Plane

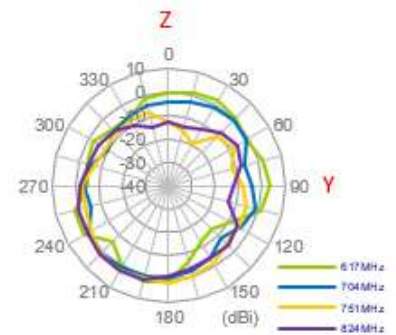
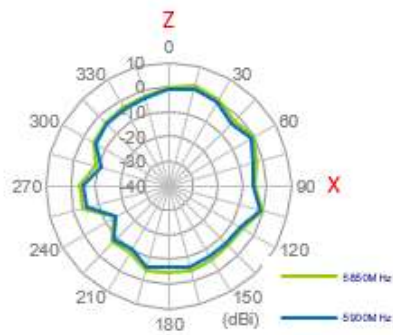
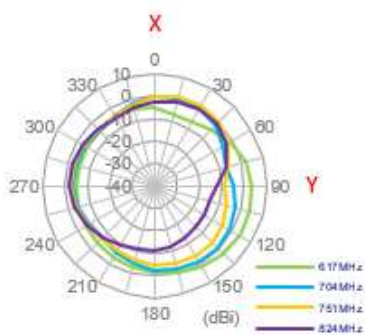

704MHz (MIMO1)

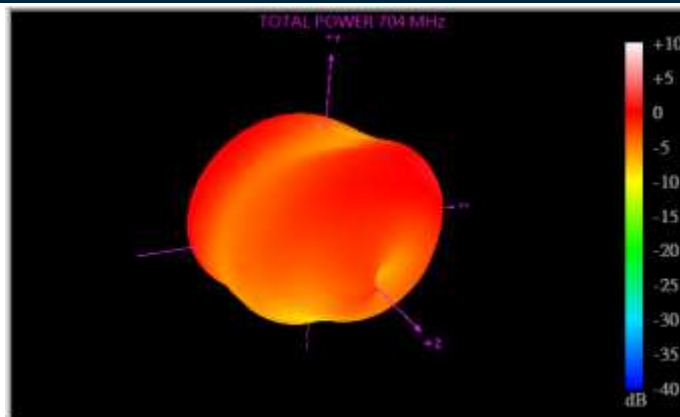

XY Plane

XZ Plane

YZ Plane

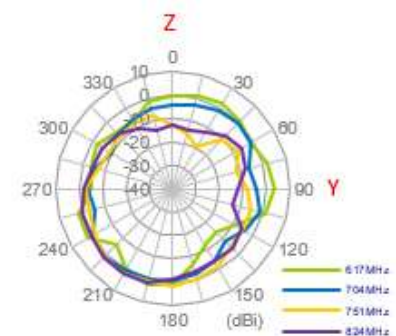
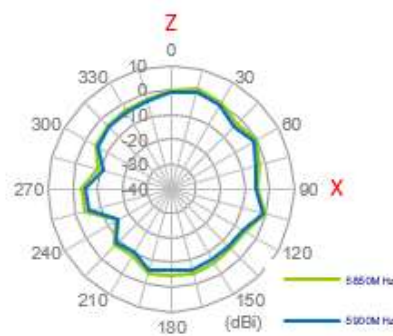
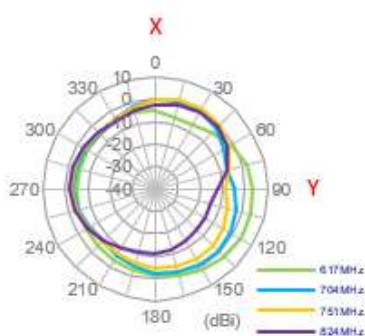

751MHz (MIMO1)

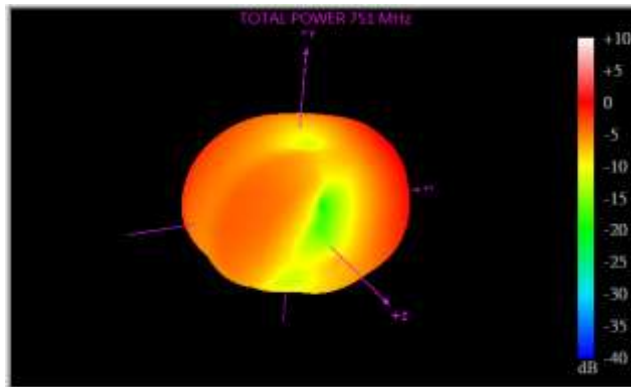

XY Plane

XZ Plane

YZ Plane

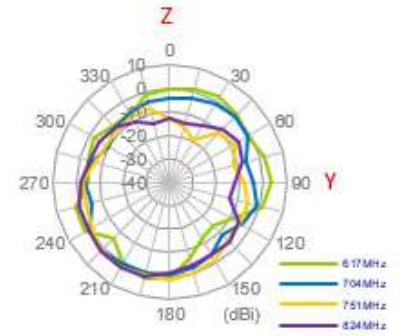
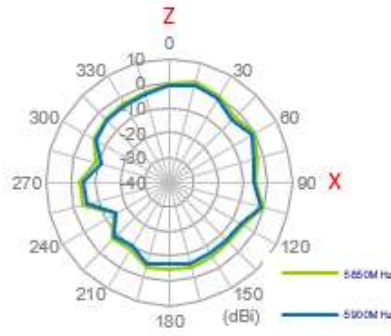
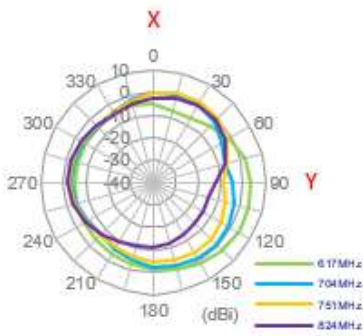

824MHz (MIMO1)

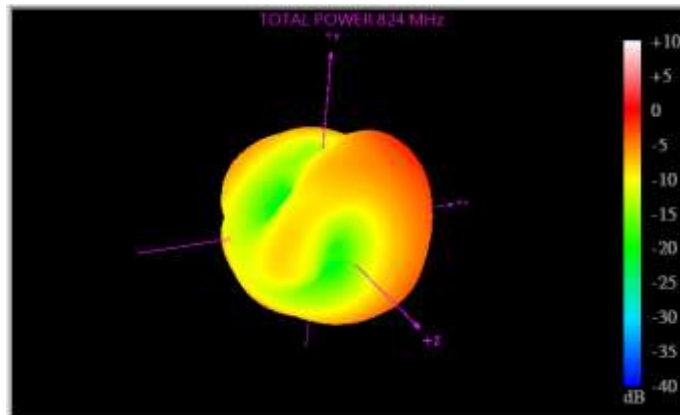

XY Plane

XZ Plane

YZ Plane

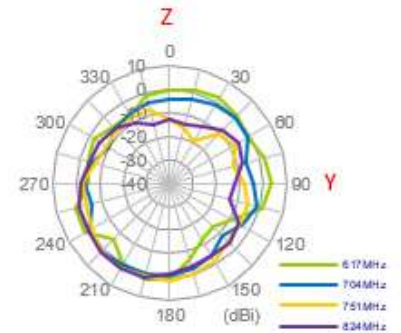
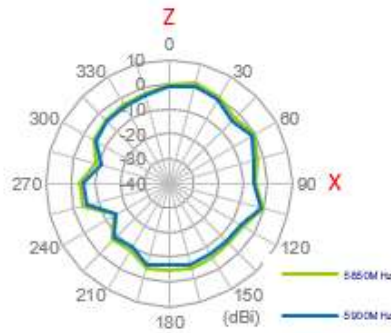
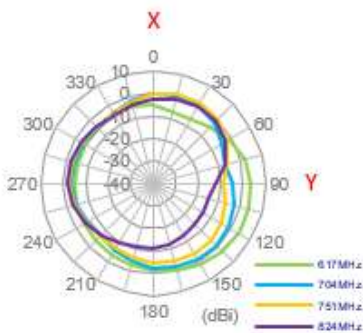

960MHz (MIMO1)

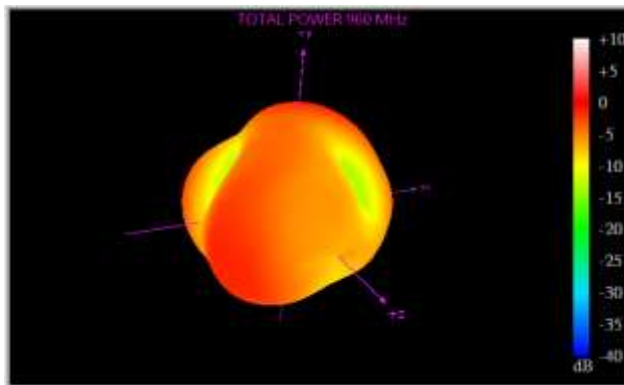

XY Plane

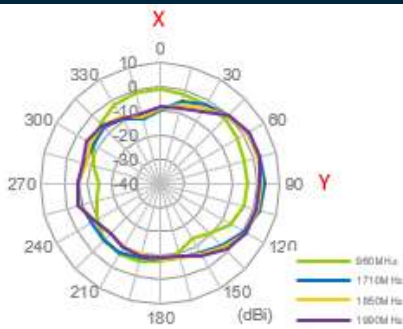

XZ Plane

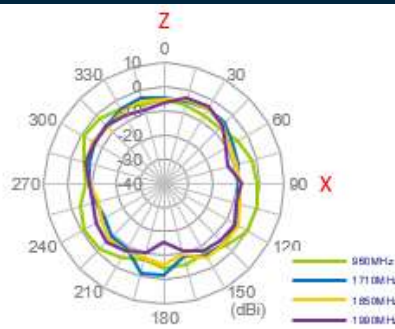

YZ Plane

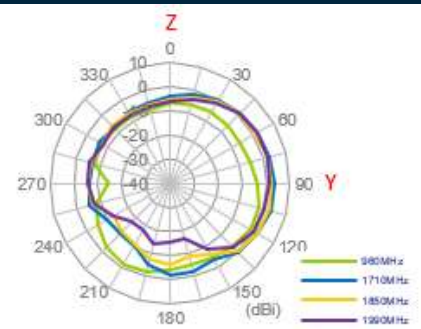

1710MHz (MIMO1)

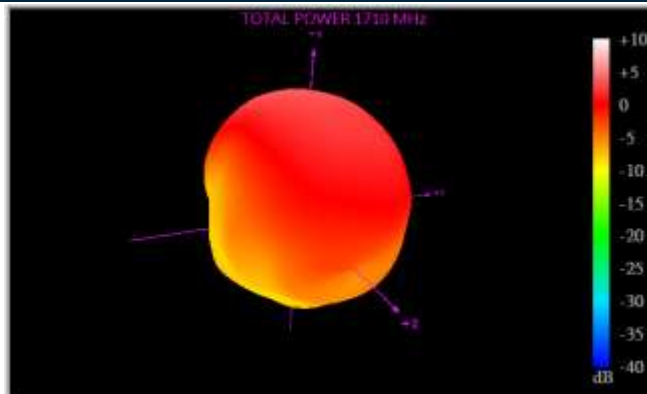

XY Plane

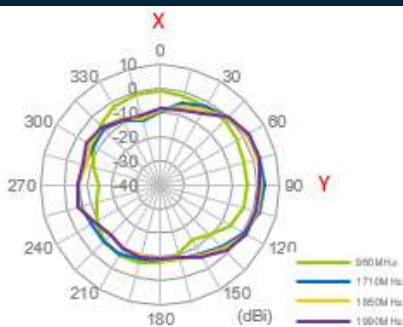

XZ Plane

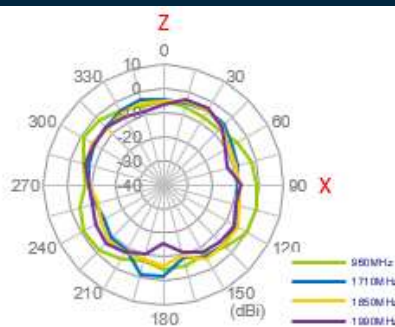

YZ Plane

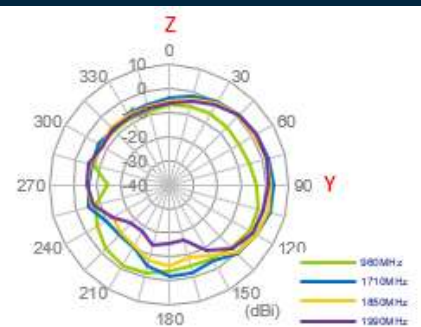

1850MHz (MIMO1)

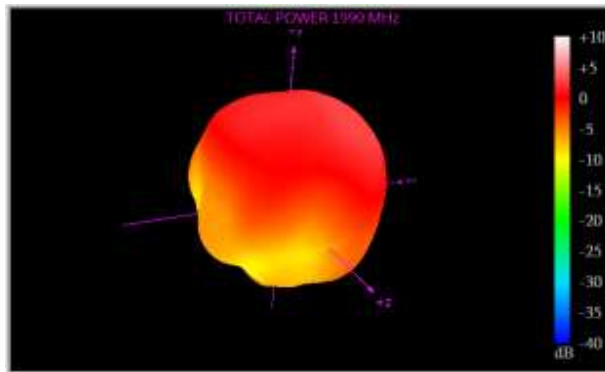

XY Plane

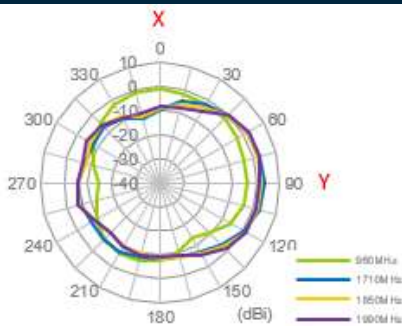

XZ Plane

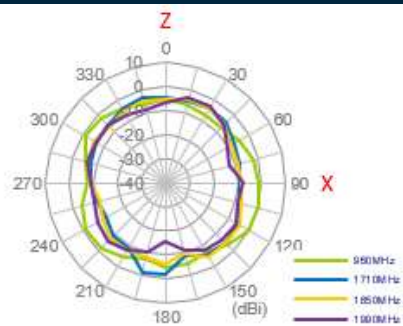

YZ Plane

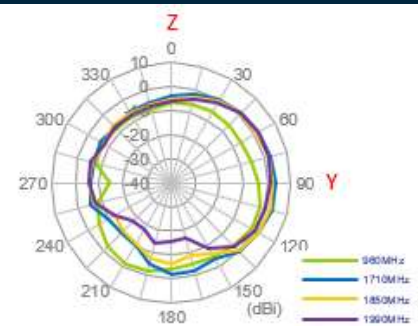

1990MHz (MIMO1)

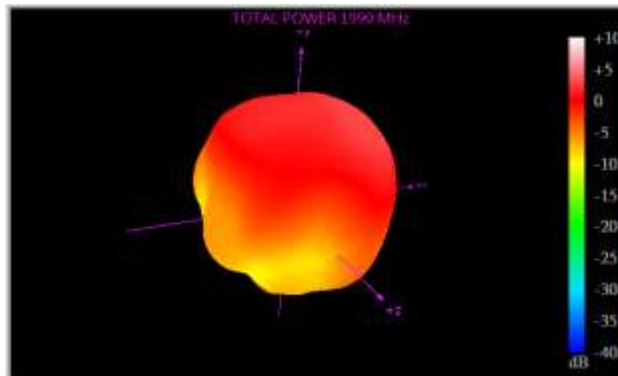

XY Plane

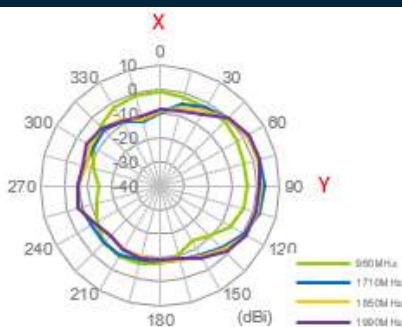

XZ Plane

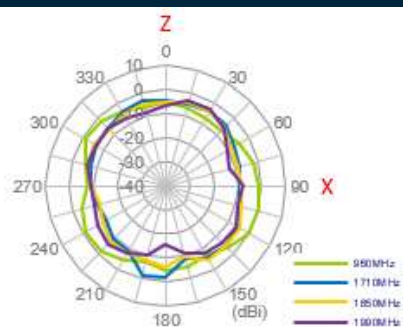

YZ Plane

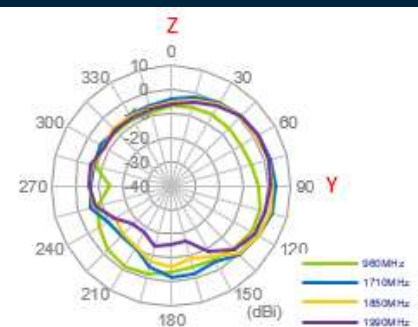

2170MHz (MIMO1)

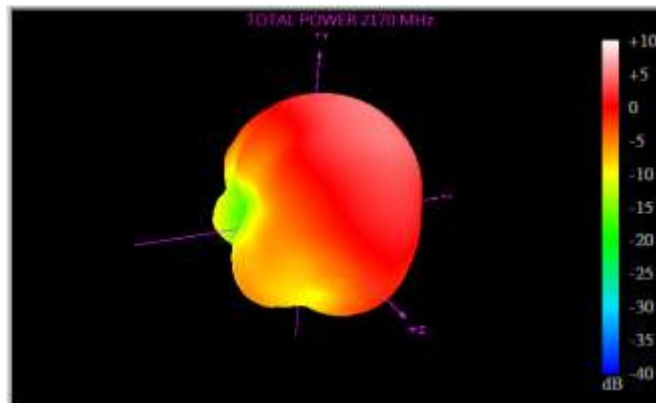

XY Plane

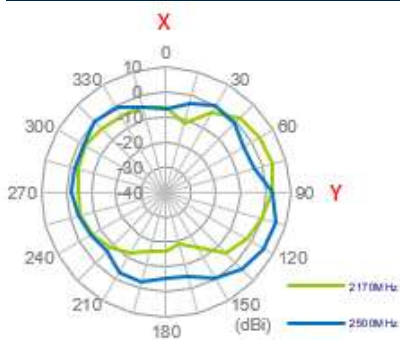

XZ Plane

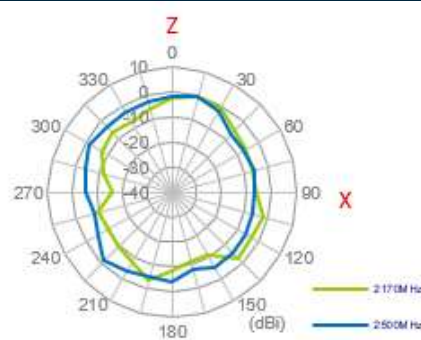

YZ Plane

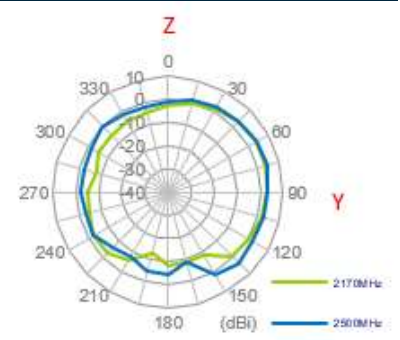

2500MHz (MIMO1)

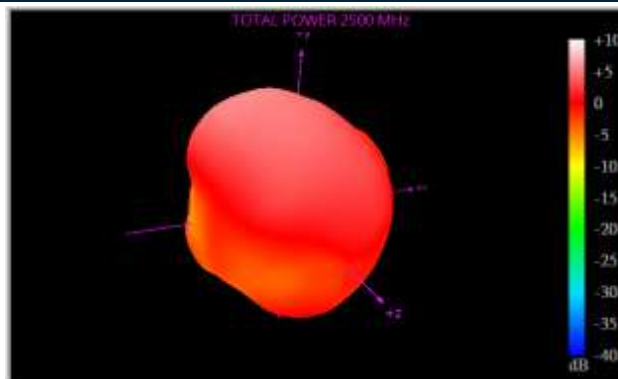

XY Plane

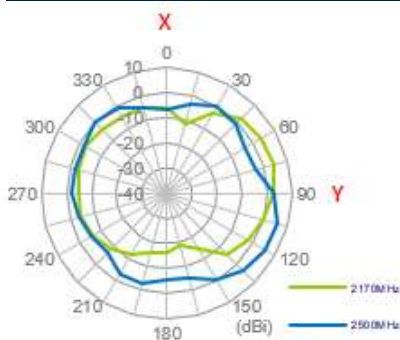

XZ Plane

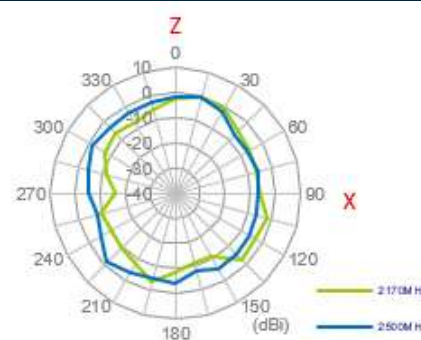

YZ Plane

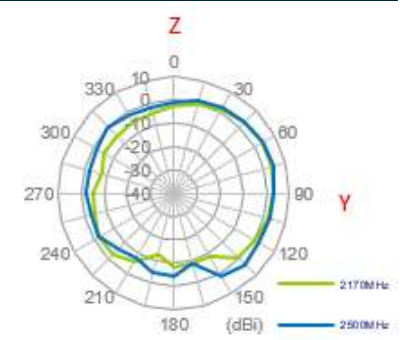

2690MHz (MIMO1)

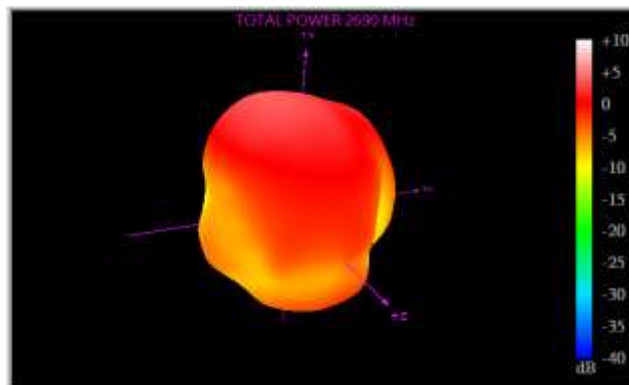

XY Plane

XZ Plane

YZ Plane

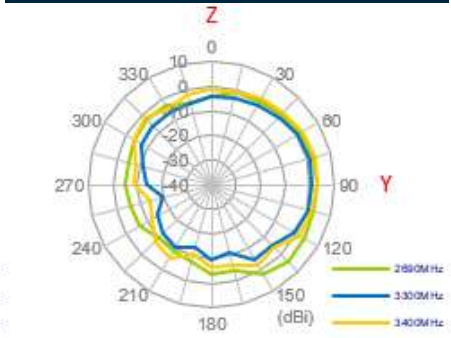
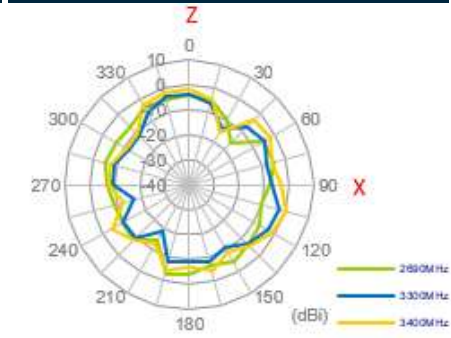
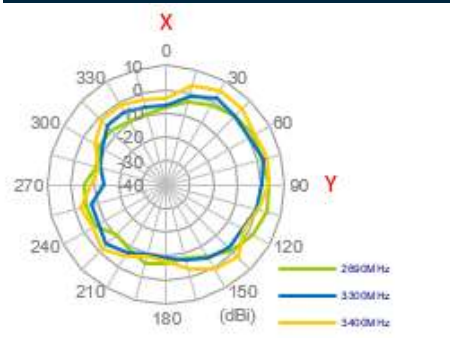

3300MHz (MIMO1)

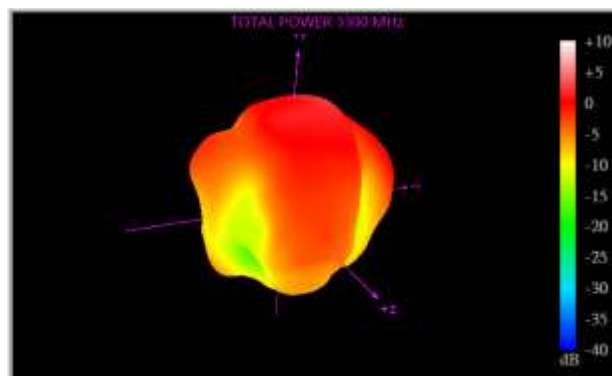

XY Plane

XZ Plane

YZ Plane

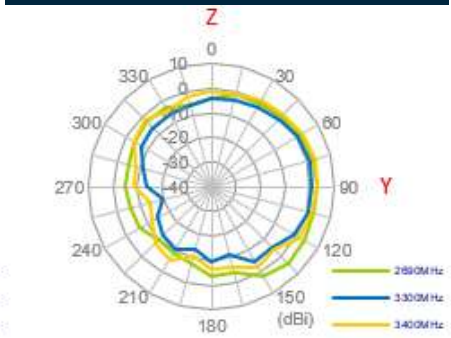
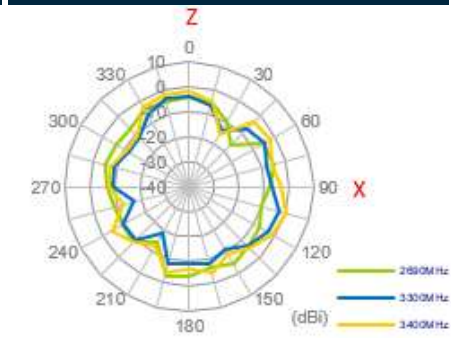
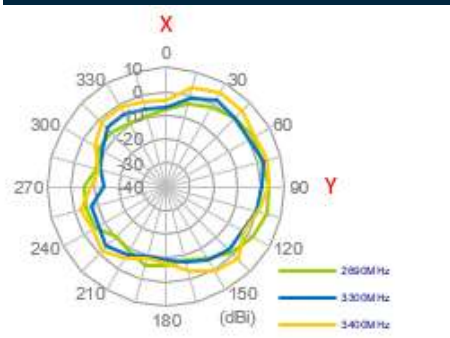

3400MHz (MIMO1)

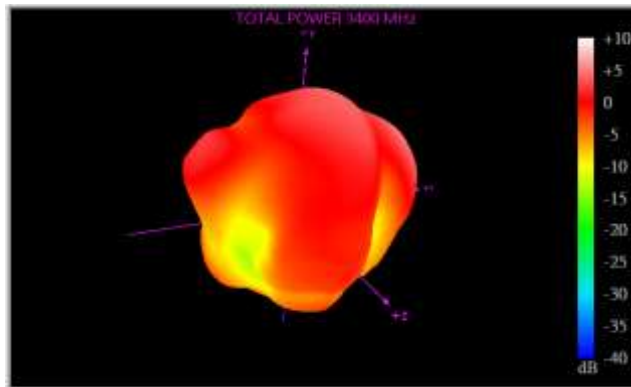

XY Plane

XZ Plane

YZ Plane

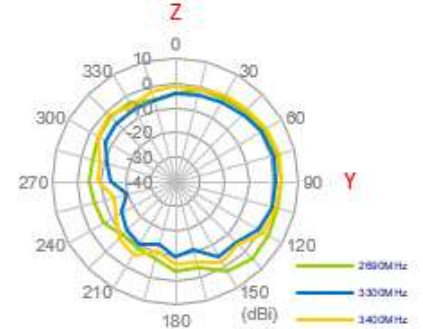
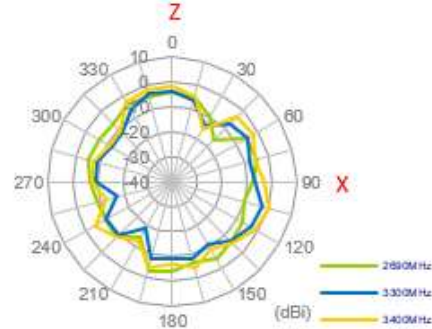
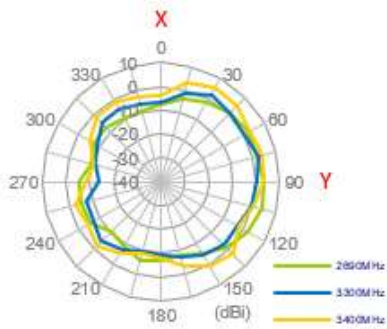

150MHz (MIMO1)

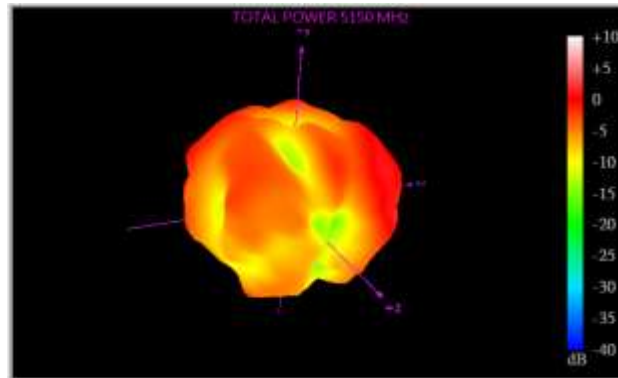

XY Plane

XZ Plane

YZ Plane

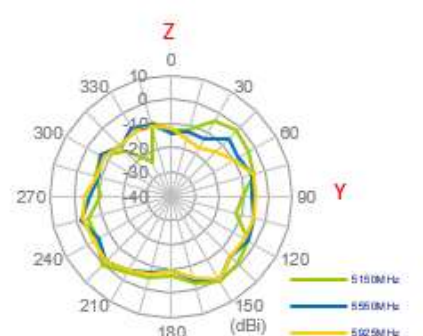
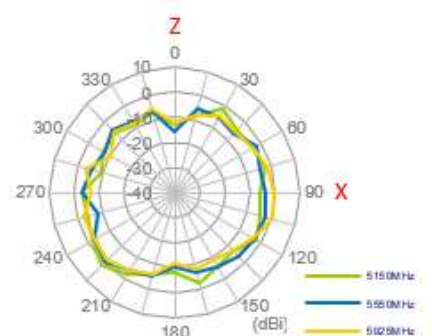
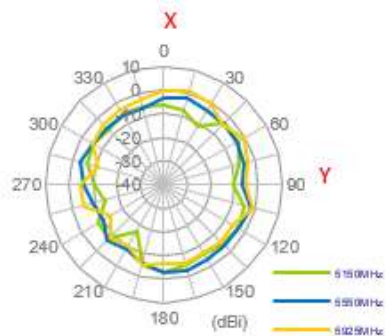

5550MHz (MIMO1)

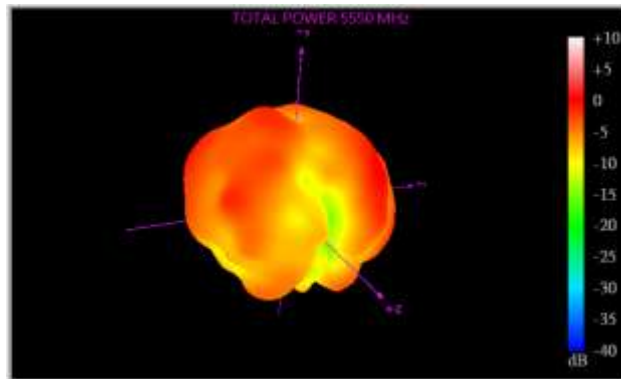

XY Plane

XZ Plane

YZ Plane

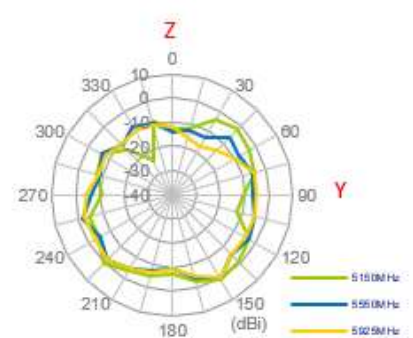
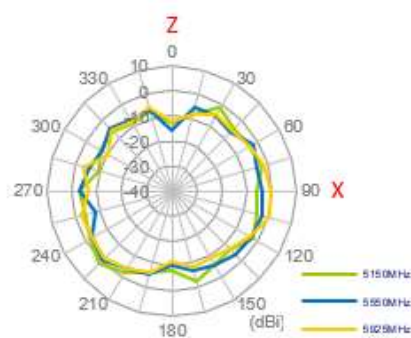
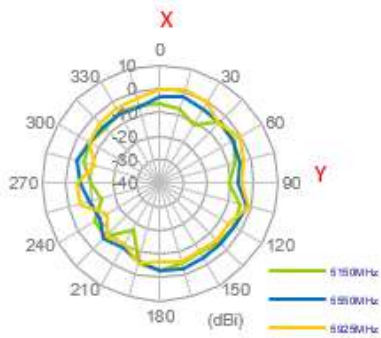

5925MHz (MIMO1)

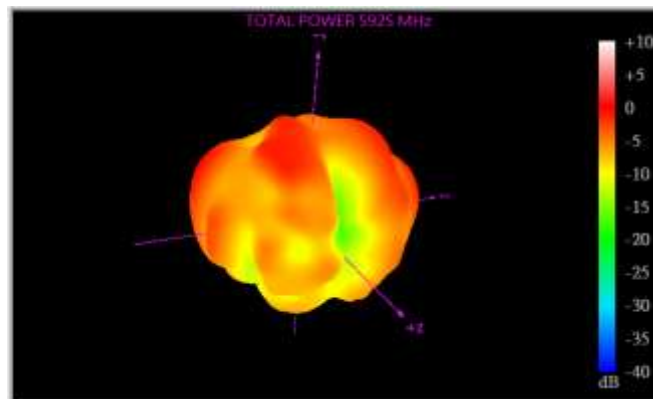

XY Plane

XZ Plane

YZ Plane

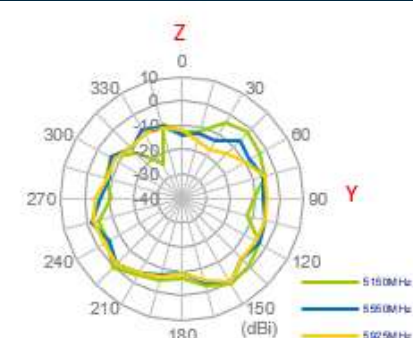
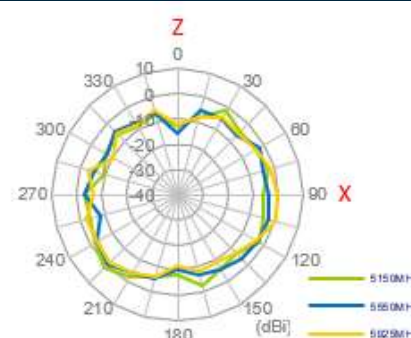
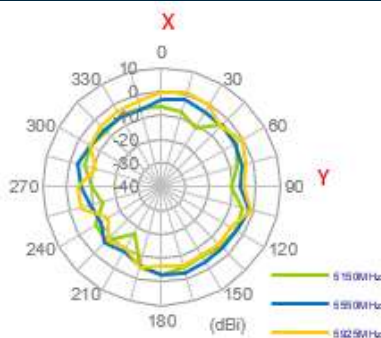

617MHz (MIMO2)

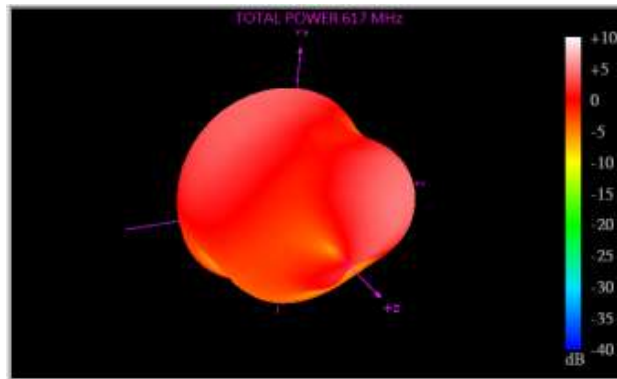

XY Plane

XZ Plane

YZ Plane

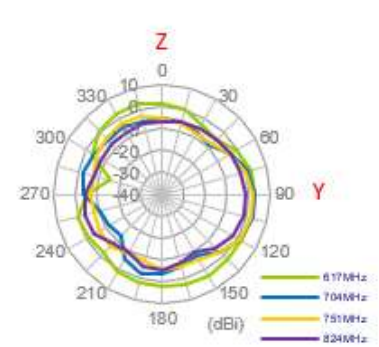
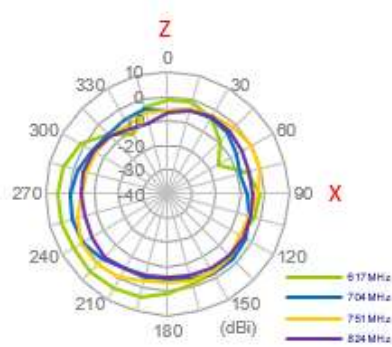
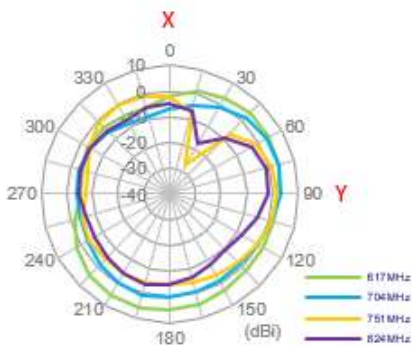

704MHz (MIMO2)

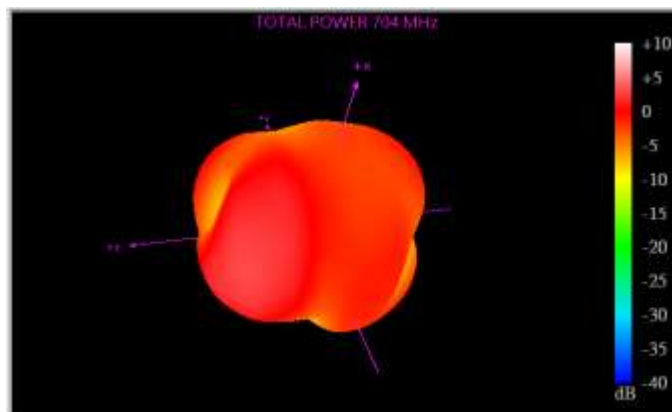

XY Plane

XZ Plane

YZ Plane

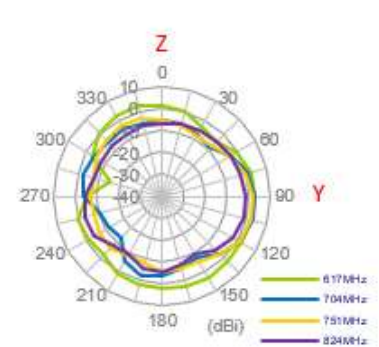
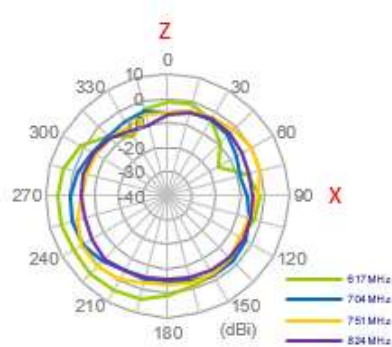
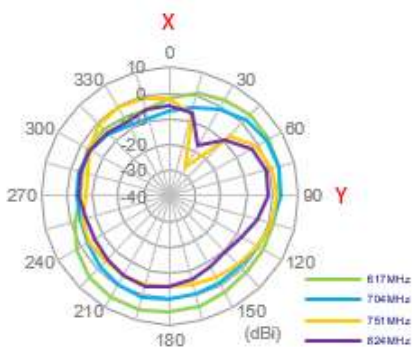

751MHz (MIMO2)

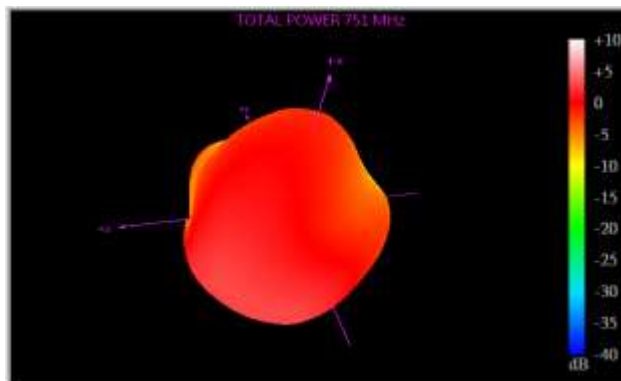

XY Plane

XZ Plane

YZ Plane

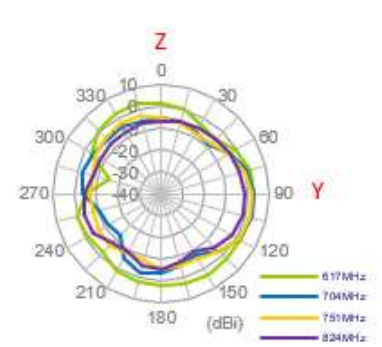
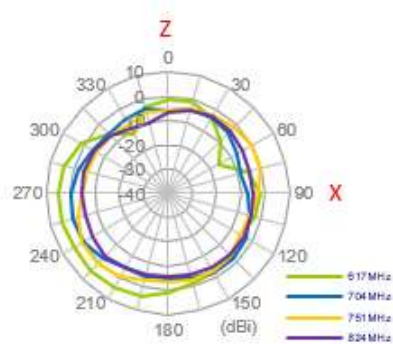
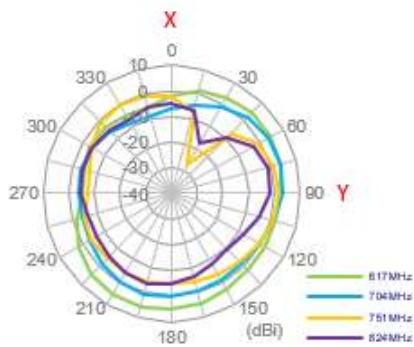

824MHz (MIMO2)

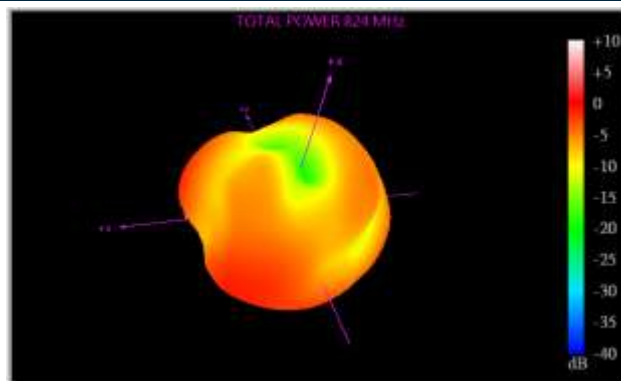

XY Plane

XZ Plane

YZ Plane

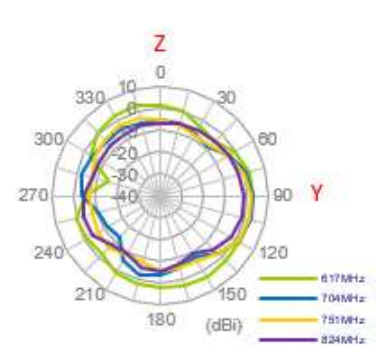
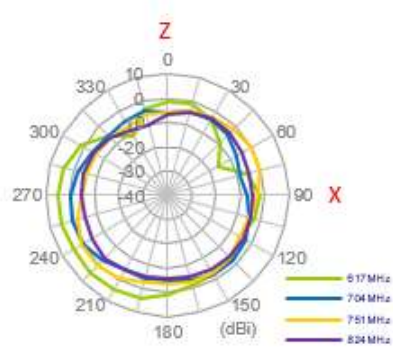
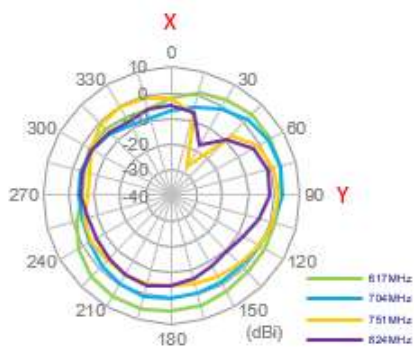

960MHz (MIMO2)

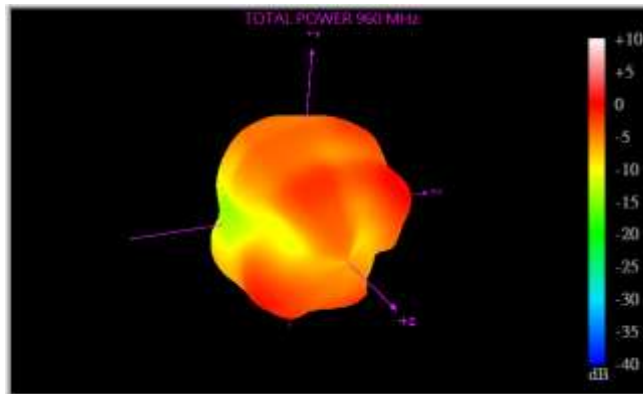

XY Plane

XZ Plane

YZ Plane

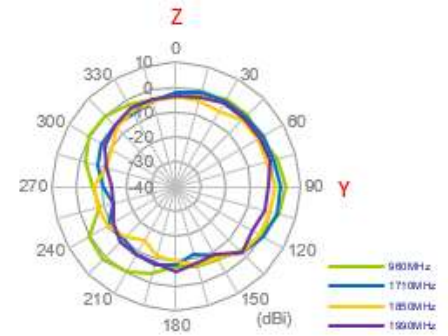
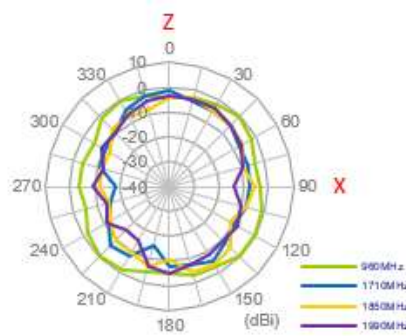
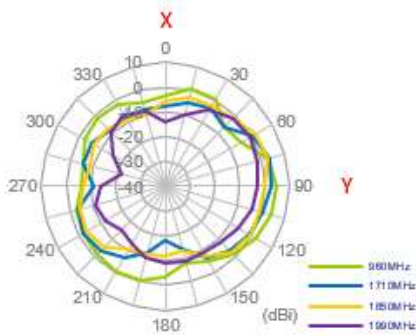

1710MHz (MIMO2)

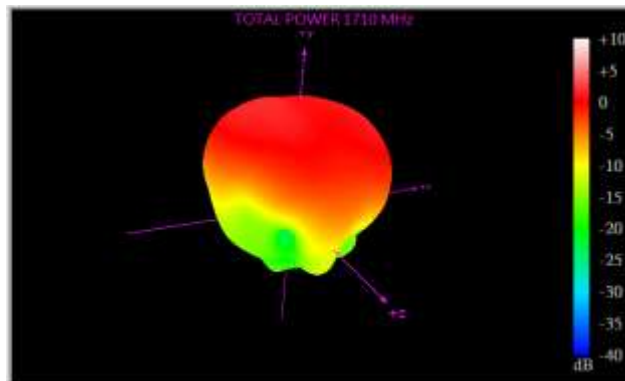

XY Plane

XZ Plane

YZ Plane

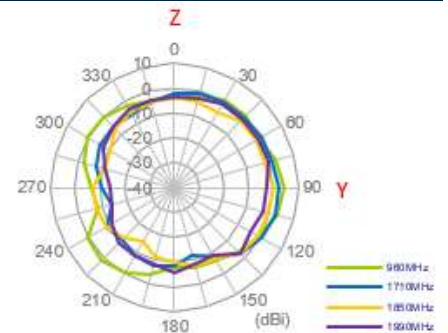
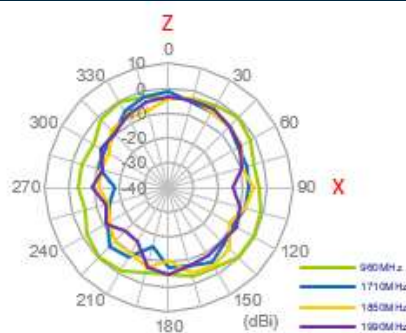
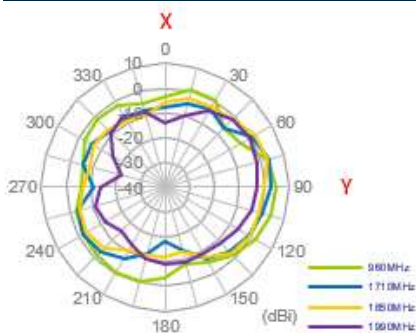

1850MHz (MIMO2)

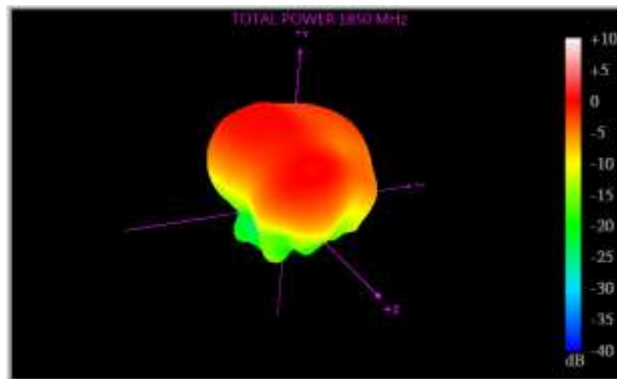

XY Plane

XZ Plane

YZ Plane

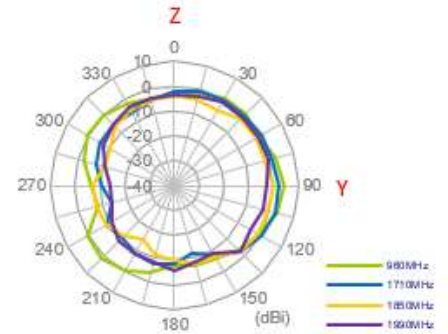
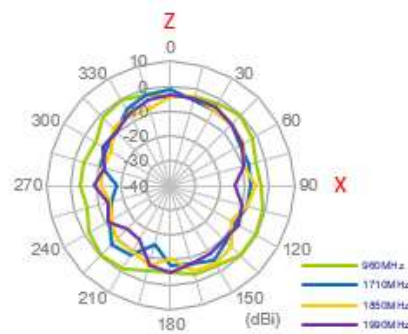
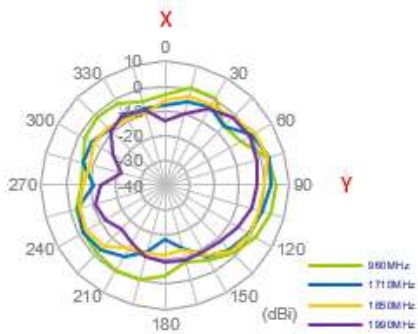

1990MHz (MIMO2)

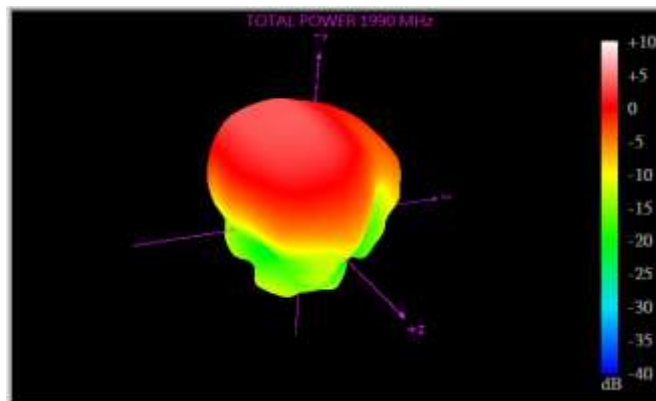

XY Plane

XZ Plane

YZ Plane

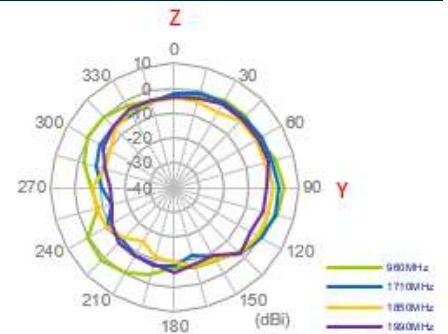
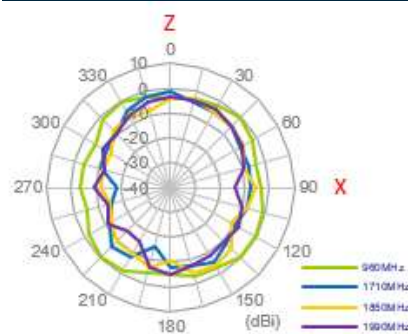
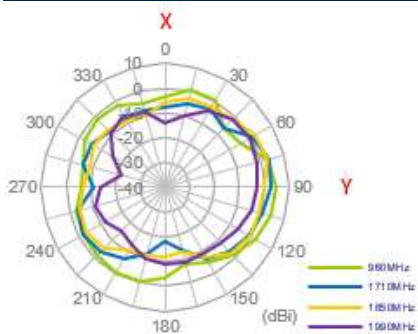

2170MHz (MIMO2)

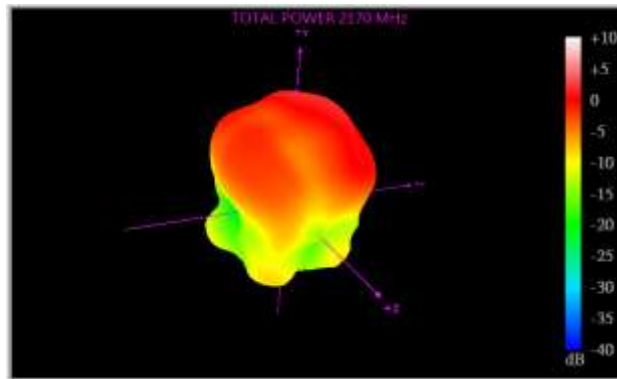

XY Plane

XZ Plane

YZ Plane

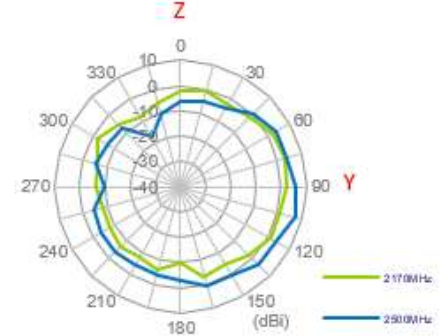
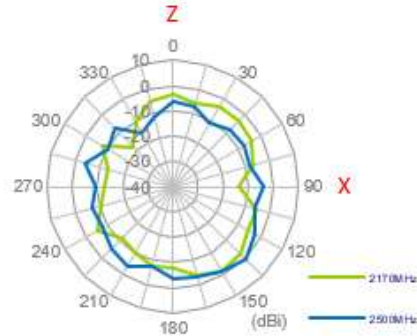
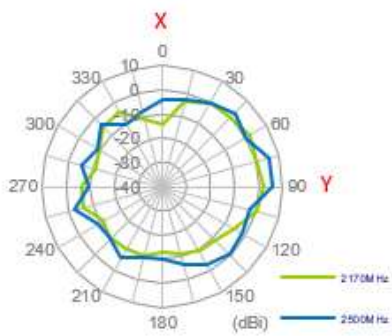

2500MHz (MIMO2)

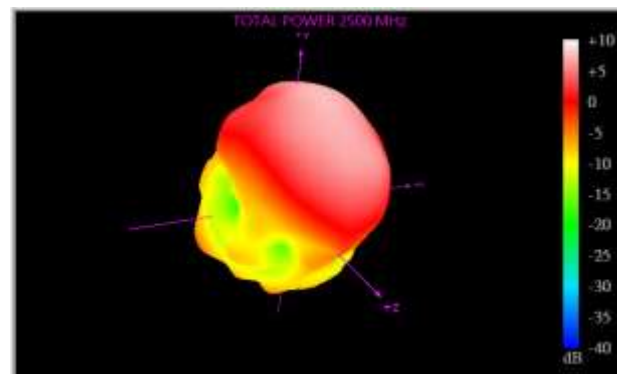

XY Plane

XZ Plane

YZ Plane

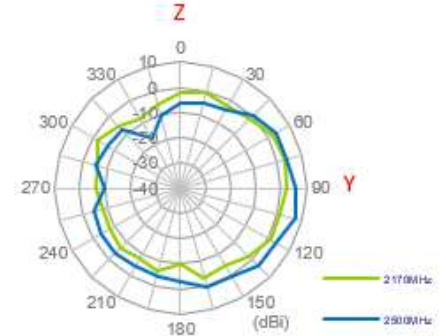
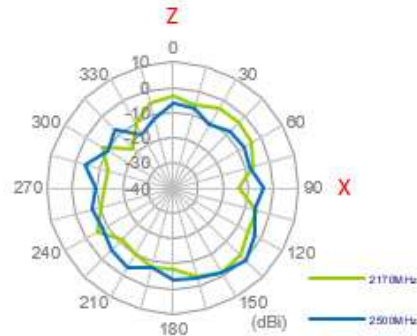
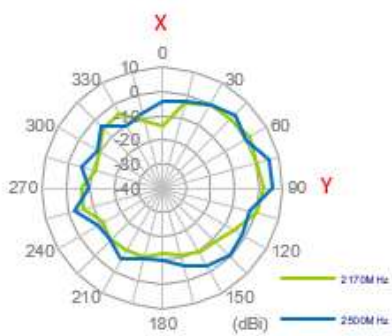

2690MHz (MIMO2)

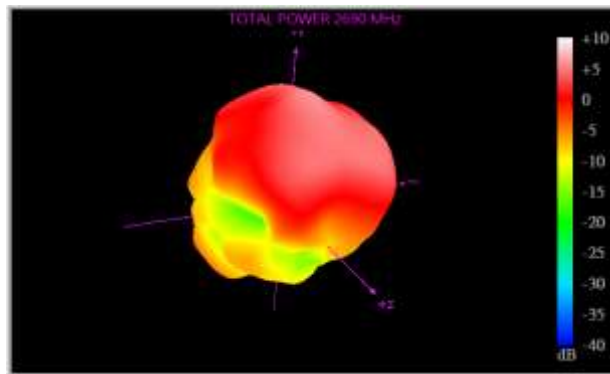

XY Plane

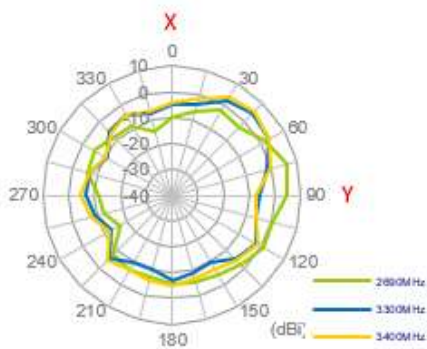

XZ Plane

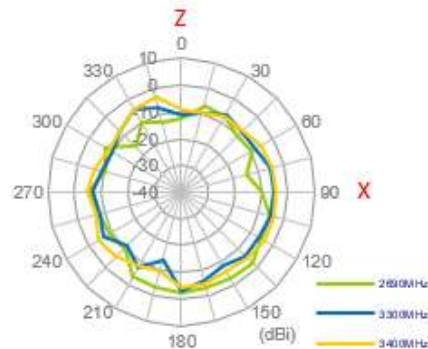

YZ Plane

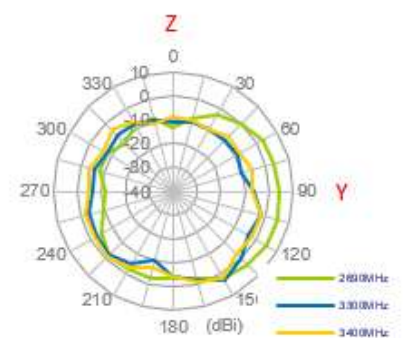

3300MHz (MIMO2)

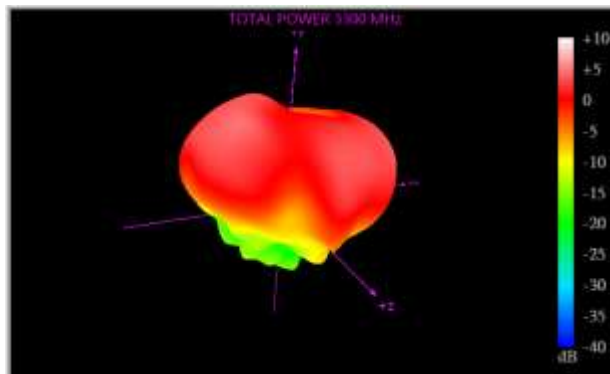

XY Plane

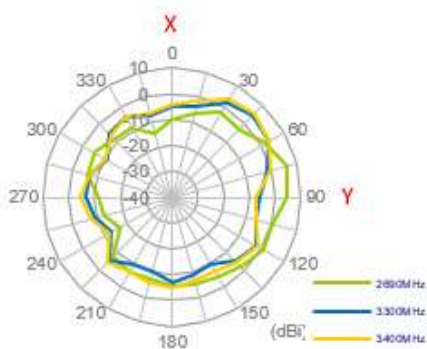

XZ Plane

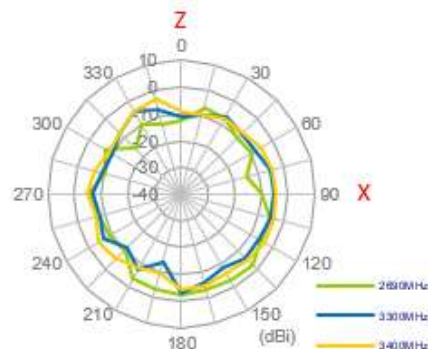

YZ Plane

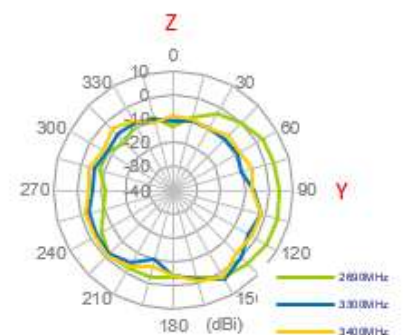

3400MHz (MIMO2)

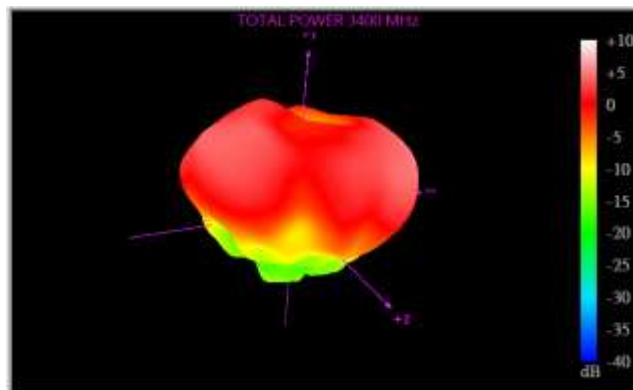

XY Plane

XZ Plane

YZ Plane

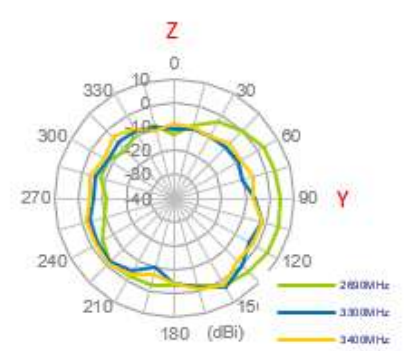
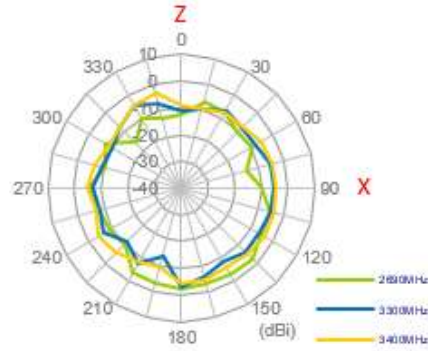
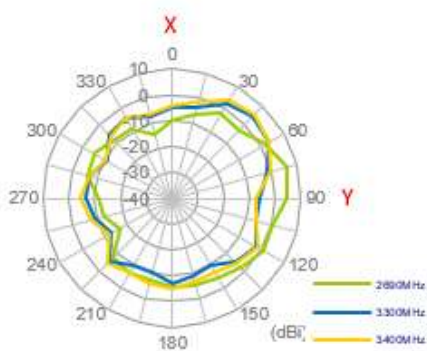

5150MHz (MIMO2)

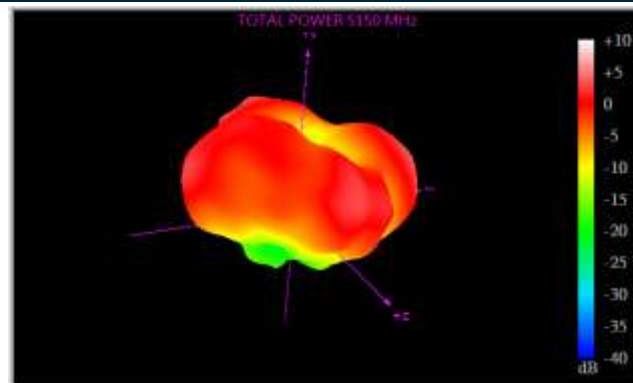

XY Plane

XZ Plane

YZ Plane

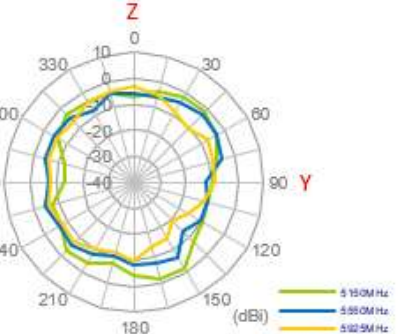
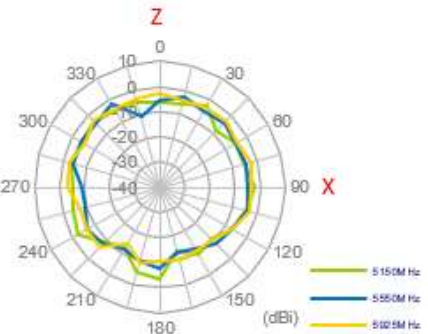
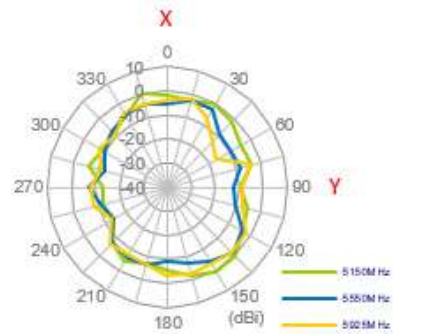

5550MHz (MIMO2)

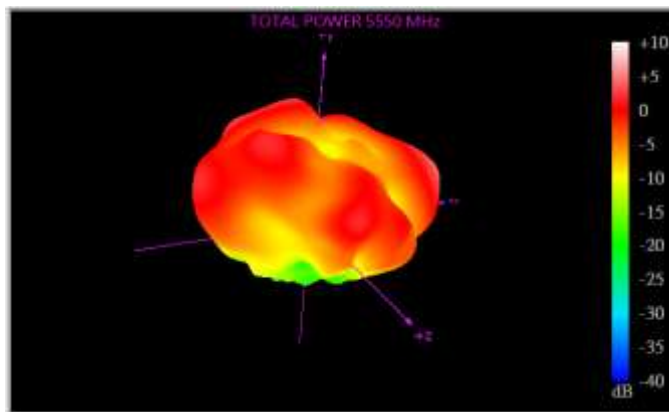

XY Plane

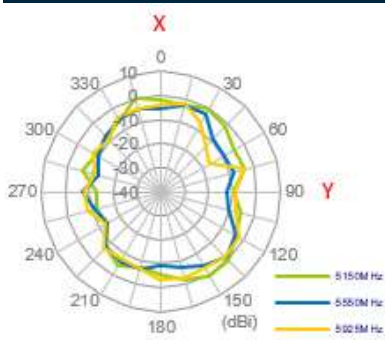

XZ Plane

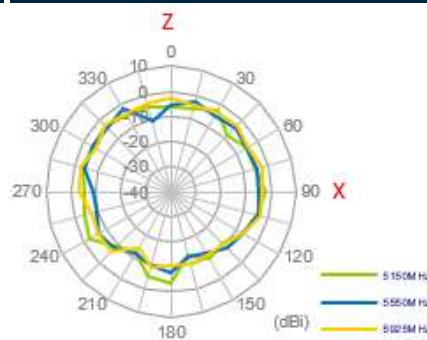

YZ Plane

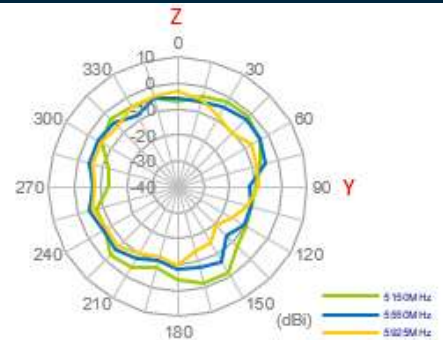

5925MHz (MIMO)

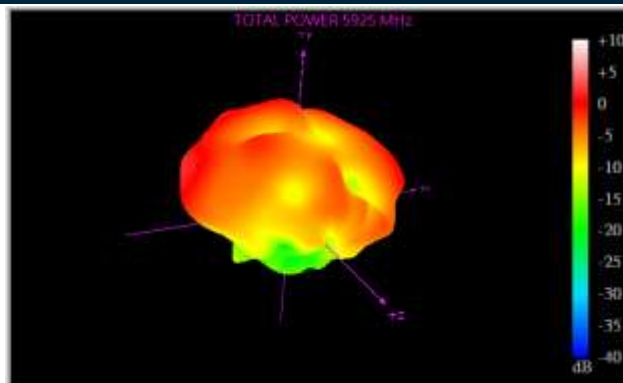

XY Plane

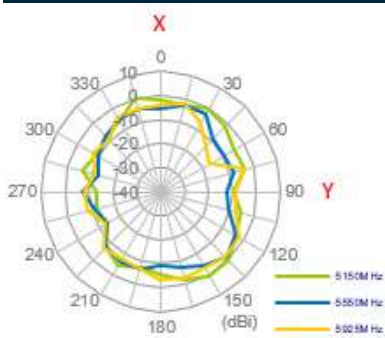

XZ Plane

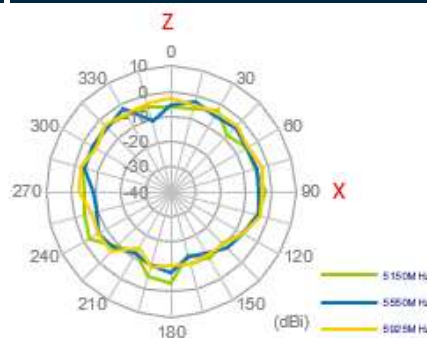

YZ Plane

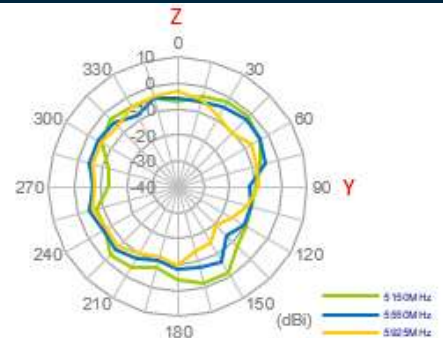

1561MHz (GNSS)

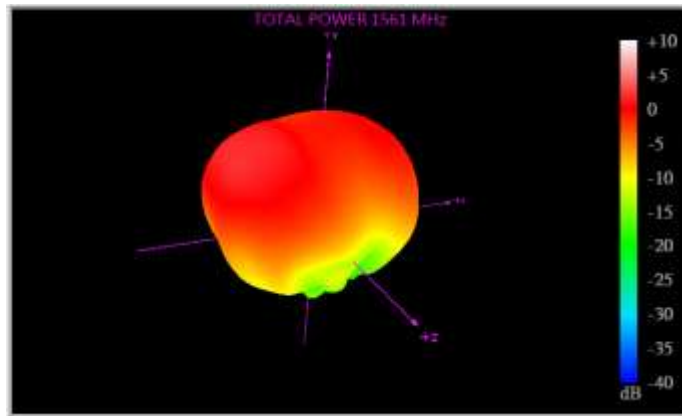

XY Plane

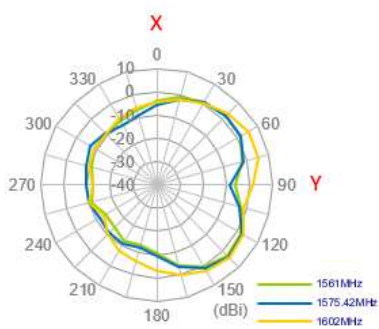

XZ Plane

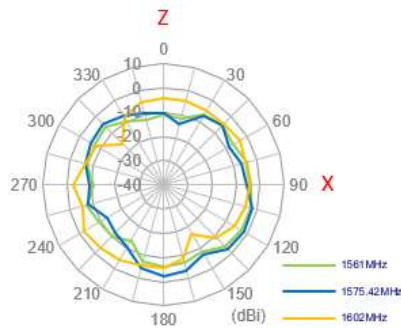

YZ Plane

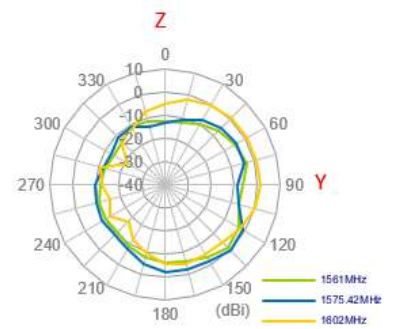

1575.42MHz (GNSS)

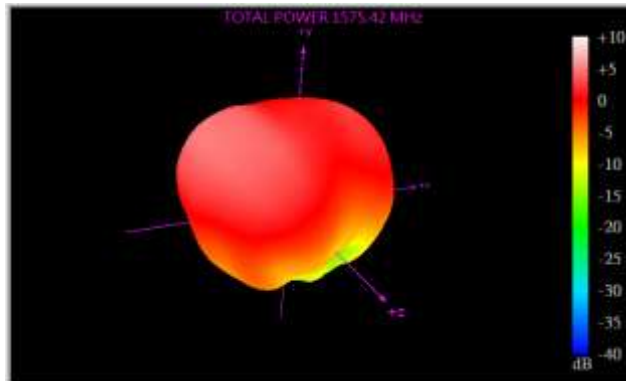

XY Plane

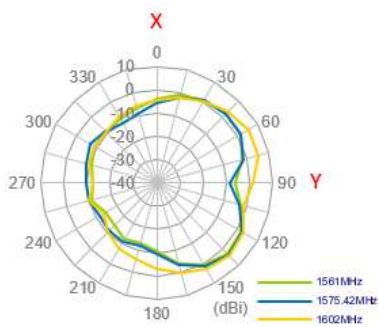

XZ Plane

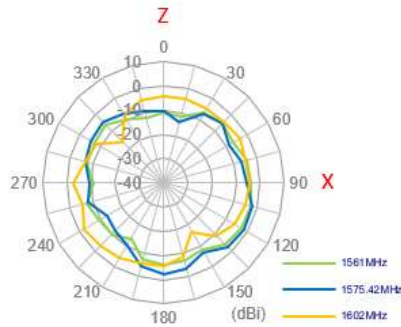

YZ Plane

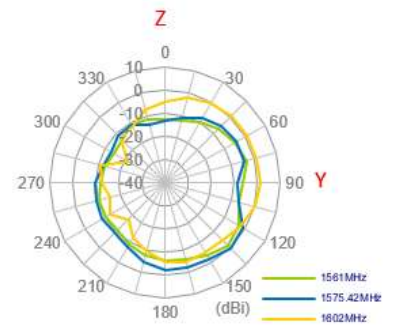

1602MHz (GNSS)

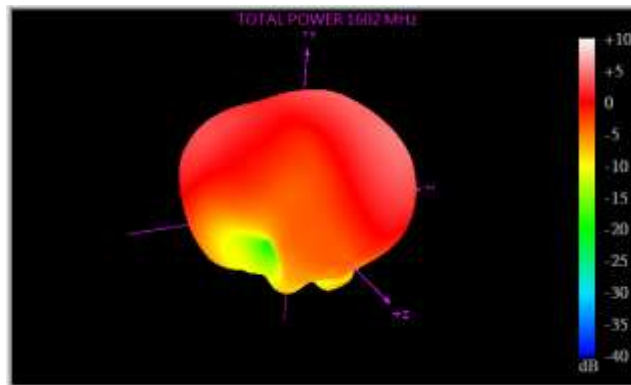

XY Plane

XZ Plane

YZ Plane

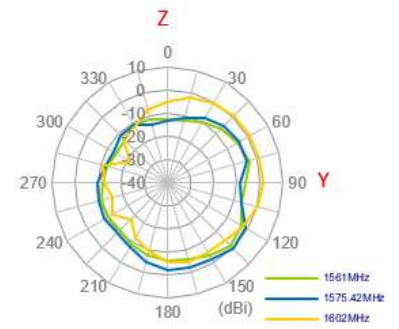
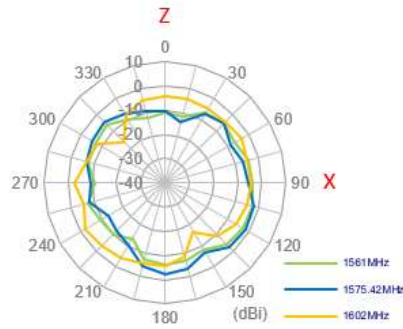
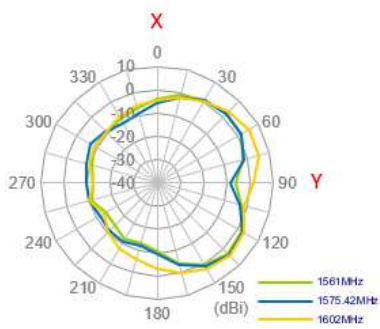

5. Mechanical Drawing (Units: mm)

Top View

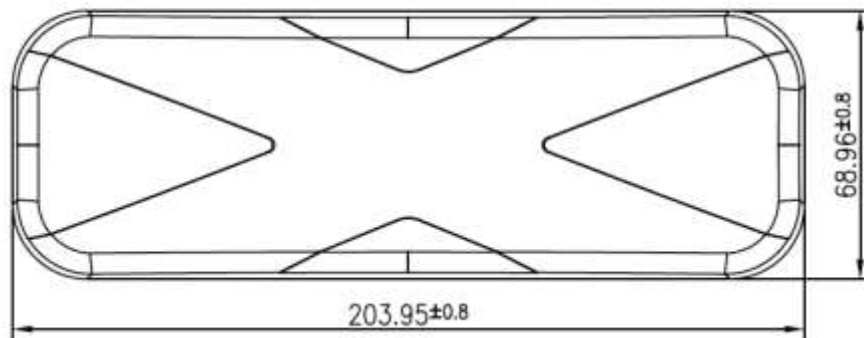

Bottom Thread View

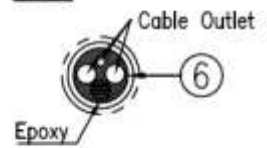

Front View

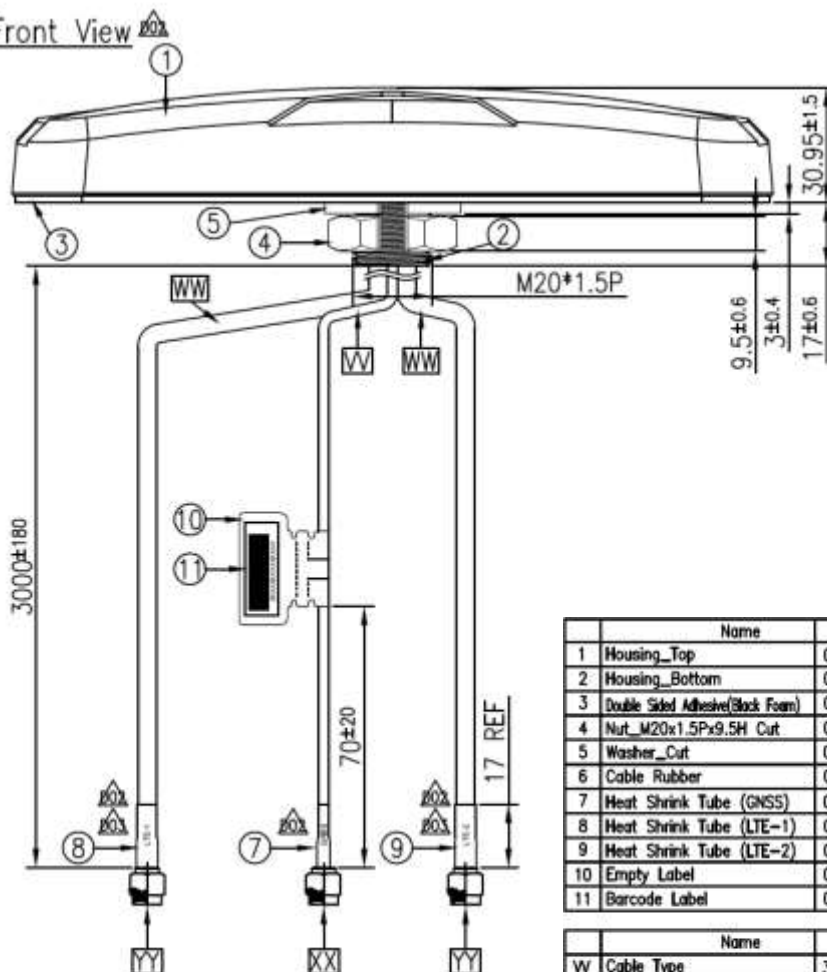

Name	P/N	Material	Finish	QTY
1 Housing_Top	000117B100000A	ABS+PC	Black	1
2 Housing_Bottom	000117B110000A	ABS+PC	Black	1
3 Double Sided Adhesive(Black Foam)	001017B050000A	3M 9448BK+CR4305	White Liner	1
4 Nut_M20x1.5Px9.5H Cut	000413E030061A	Steel	Ni-Zn Plated	1
5 Washer_Cut	000413E040061A	Steel	Ni-Zn Plated	1
6 Cable Rubber	000713E000063A	Silicone Rubber	Black	1
7 Heat Shrink Tube (GNSS)	001316C000000A	PE	Blue Tube/White Text	1
8 Heat Shrink Tube (LTE-1)	001317C020000A	PE	Red Tube/White Text	1
9 Heat Shrink Tube (LTE-2)	001317C030000A	PE	Red Tube/White Text	1
10 Empty Label	001015G000000A	PEPA	White	1
11 Barcode Label	001015G010000A	PET	White	1

Name	P/N	SPEC	Finish	QTY
W Cable Type	301315C000000A	RG174	Black	1
WW Cable Type	301415C010000A	CFD200	Black	2
XX Connector Type	200216D000098A	SMA(M)/ST	Au Plated	1
YY Connector Type	200216D020098A	SMA(M)/ST	Au Plated	2

6. Packaging



16 pcs MA173.A.LBI.001 per carton
 Carton Dimensions - 510*510*250mm
 Total Weight - 9.7kg

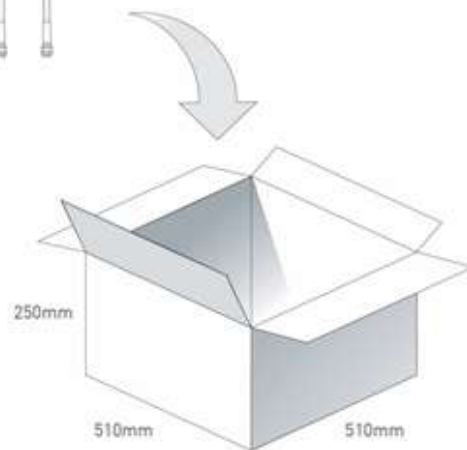

Carton top view

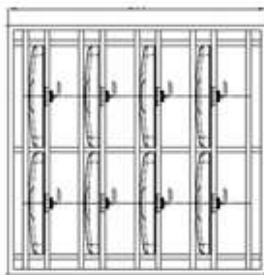

Carton side view

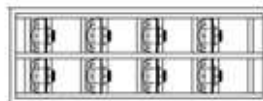

Pallet Dimensions 1200mm*1000mm*1450mm
 20 Cartons per pallet
 4 Cartons per layer
 5 Layers

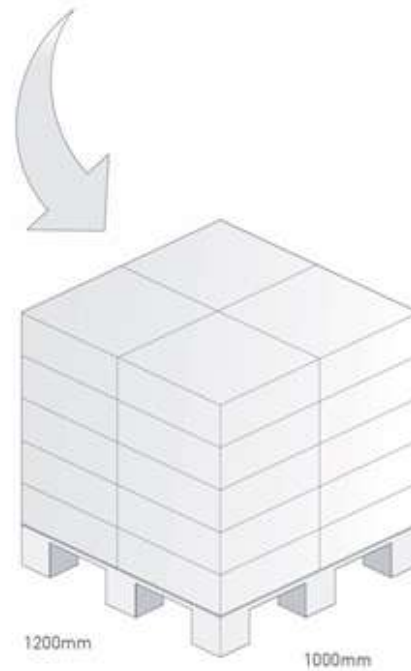

Changelog for the datasheet

SPE-18-8-112 - MA173.A.LBI.001

Revision: B (Current Version)

Date:	2021-09-02
Notes:	Updated RF Data
Author:	Gary West

Previous Revisions

Revision: A (Original First Release)

Date:	2019-03-13
Notes:	
Author:	Jack Conroy



TAOGLAS®

www.taoglas.com

