

HEIDI-RS

~8° spot beam

TECHNICAL SPECIFICATIONS:

Dimensions	Ø 21.6 mm
Height	11.7 mm
Fastening	tape, pin
ROHS compliant	yes ⓘ

MATERIAL SPECIFICATIONS:

Component	Type	Material	Colour	Finish
HEIDI-RS	Single lens	PMMA	clear	
HEIDI-TAPE	Tape	Acrylic foam	black	

ORDERING INFORMATION:

Component		Qty in box	MOQ	MPQ	Box weight (kg)
CA11663_HEIDI-RS	Single lens	3264	204	204	10.4
» Box size: 480 x 280 x 300 mm					



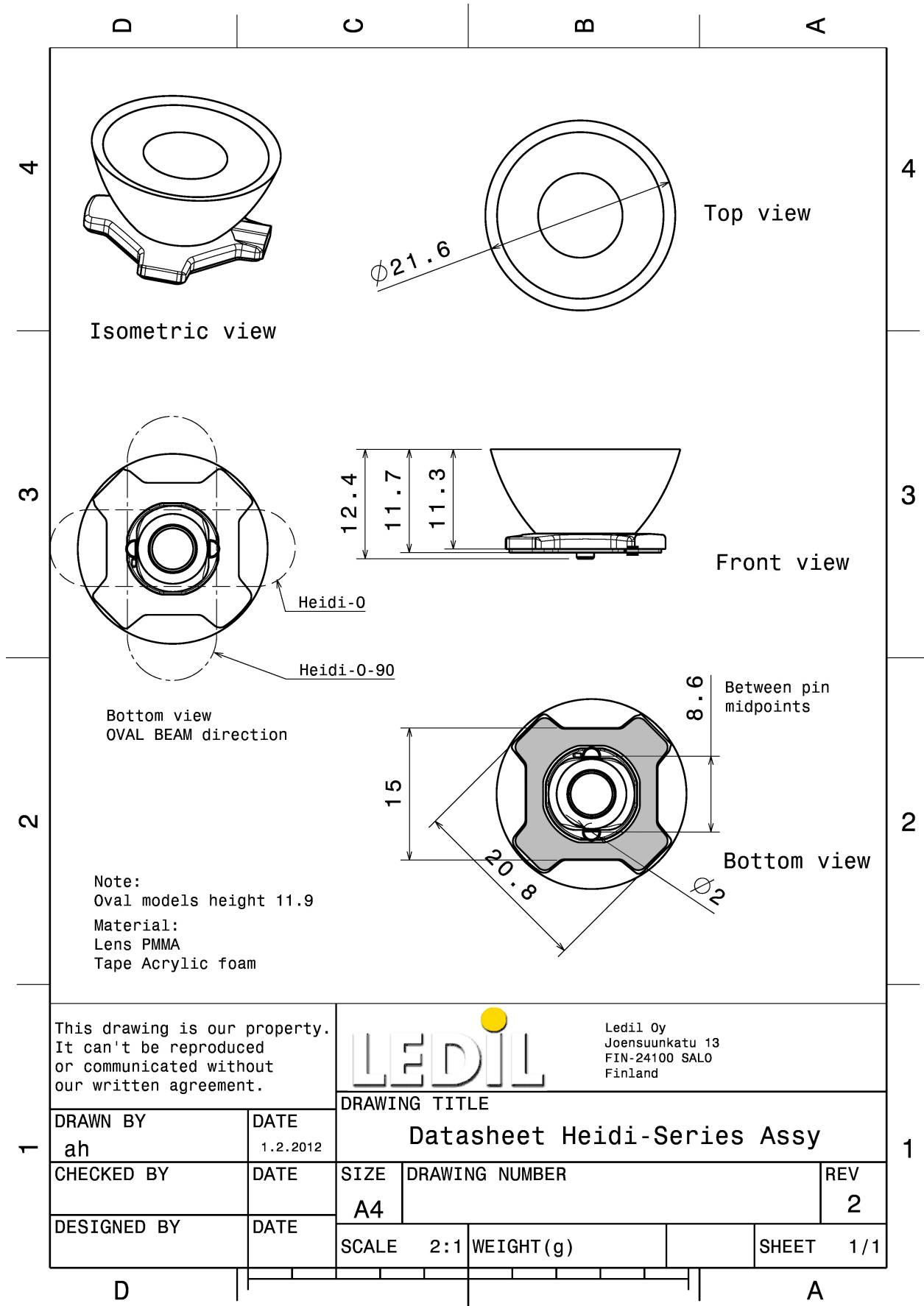

See also our general installation guide: www.ledil.com/installation_guide

PHOTOMETRIC DATA (MEASURED):

CREE LED

LED XB-D
 FWHM / FWTM 8.0°
 Efficiency 91 %
 Peak intensity 19.7 cd/lm
 LEDs/each optic 1
 Light colour White
 Required components:

CREE LED

LED XB-H
 FWHM / FWTM 10.0° / 19.0°
 Efficiency 90 %
 Peak intensity 18.3 cd/lm
 LEDs/each optic 1
 Light colour White
 Required components:

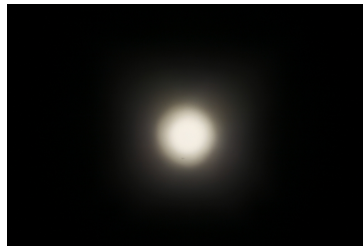

CREE LED

LED XP-E
 FWHM / FWTM 8.0° / 18.0°
 Efficiency 93 %
 Peak intensity 26.8 cd/lm
 LEDs/each optic 1
 Light colour White
 Required components:

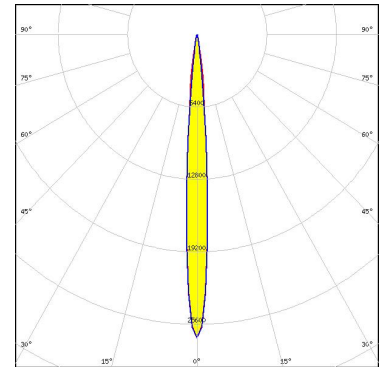

CREE LED

LED XP-E2
 FWHM / FWTM 8.0° / 14.0°
 Efficiency 90 %
 Peak intensity 38 cd/lm
 LEDs/each optic 1
 Light colour White
 Required components:

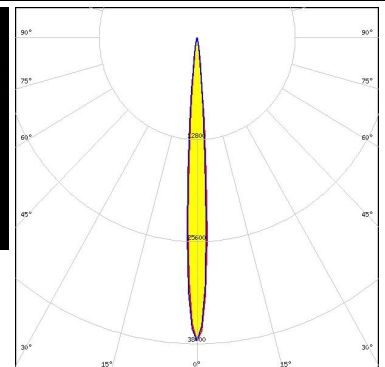

PHOTOMETRIC DATA (MEASURED):

CREE LED

LED XP-G
 FWHM / FWTM 9.0° / 20.0°
 Efficiency 93 %
 Peak intensity 16.6 cd/lm
 LEDs/each optic 1
 Light colour White
 Required components:

CREE LED

LED XP-G2
 FWHM / FWTM 11.0° / 20.0°
 Efficiency 91 %
 Peak intensity 19.1 cd/lm
 LEDs/each optic 1
 Light colour White
 Required components:

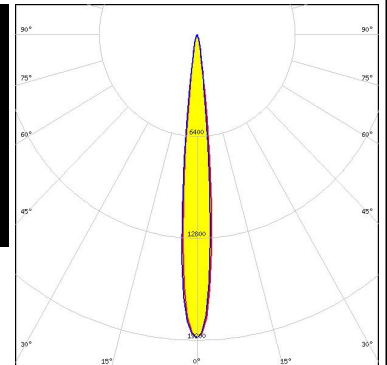

CREE LED

LED XQ-E HD
 FWHM / FWTM 6.0° / 12.0°
 Efficiency 94 %
 Peak intensity 42.1 cd/lm
 LEDs/each optic 1
 Light colour White
 Required components:

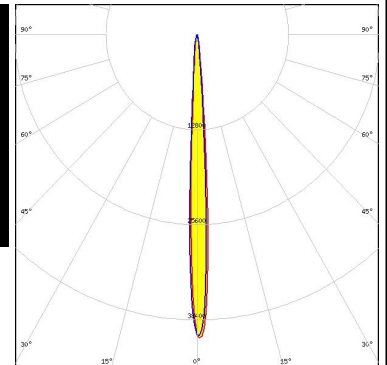
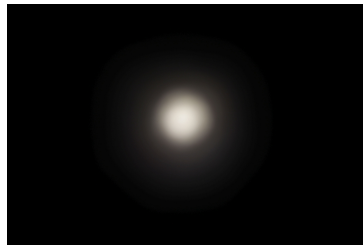



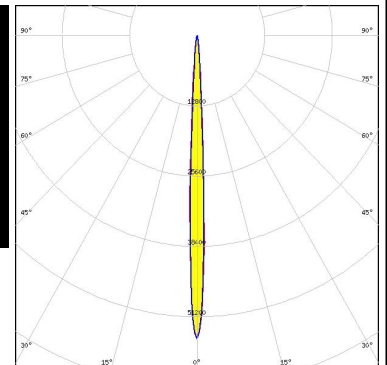
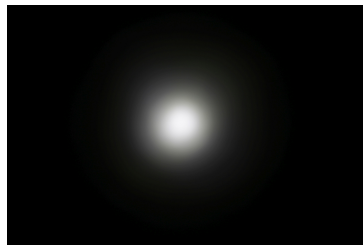

CREE LED

LED XQ-E HI
 FWHM / FWTM 5.0° / 11.0°
 Efficiency 94 %
 Peak intensity 55.2 cd/lm
 LEDs/each optic 1
 Light colour White
 Required components:

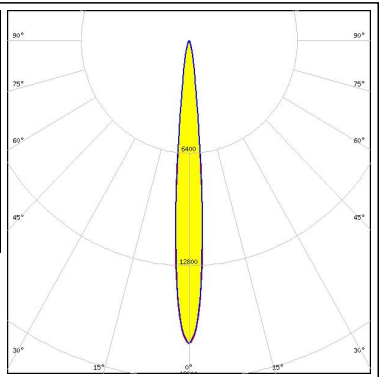
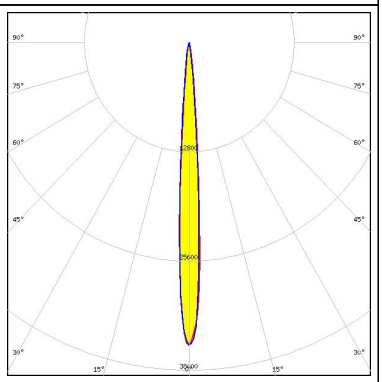

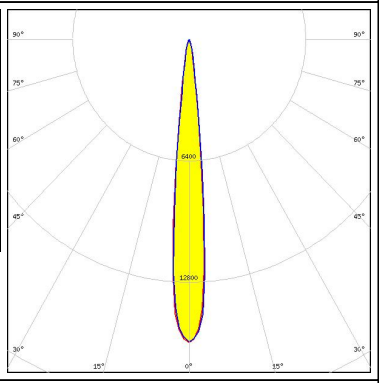
PHOTOMETRIC DATA (MEASURED):

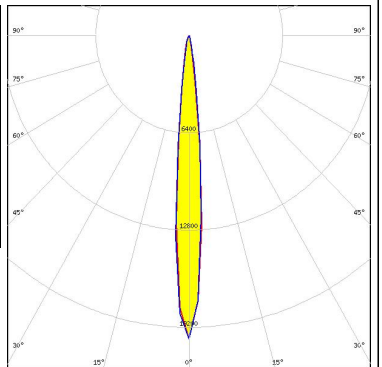
<p>CREE LED</p> <p>LED XT-E FWHM / FWTM 10.0° / 21.0° Efficiency 97 % Peak intensity 17.2 cd/lm LEDs/each optic 1 Light colour White Required components:</p>		
<p>LUMILEDS</p> <p>LED LUXEON C FWHM / FWTM 7.0° / 14.0° Efficiency 92 % Peak intensity 35.6 cd/lm LEDs/each optic 1 Light colour White Required components:</p>		
<p>LUMILEDS</p> <p>LED LUXEON T FWHM / FWTM 11.0° / 20.0° Efficiency 92 % Peak intensity 16.3 cd/lm LEDs/each optic 1 Light colour White Required components:</p>		
<p>LUMILEDS</p> <p>LED LUXEON TX FWHM / FWTM 10.0° / 20.0° Efficiency 90 % Peak intensity 19.5 cd/lm LEDs/each optic 1 Light colour White Required components:</p>		

PHOTOMETRIC DATA (MEASURED):



LED NCSxx19A
 FWHM / FWTM 8.0° / 18.0°
 Efficiency 89 %
 Peak intensity 19 cd/lm
 LEDs/each optic 1
 Light colour White
 Required components:



LED NCSxx19B
 FWHM / FWTM 9.0° / 18.0°
 Efficiency 90 %
 Peak intensity 25.2 cd/lm
 LEDs/each optic 1
 Light colour White
 Required components:

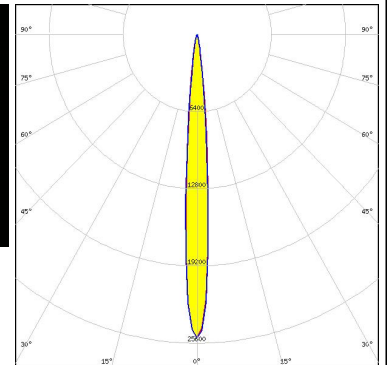
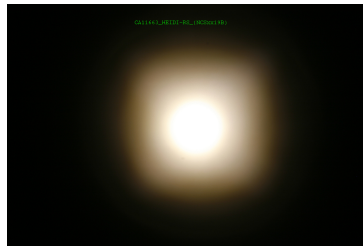



LED NVSxx19A
 FWHM / FWTM 10.0° / 23.0°
 Efficiency 89 %
 Peak intensity 13.9 cd/lm
 LEDs/each optic 1
 Light colour White
 Required components:

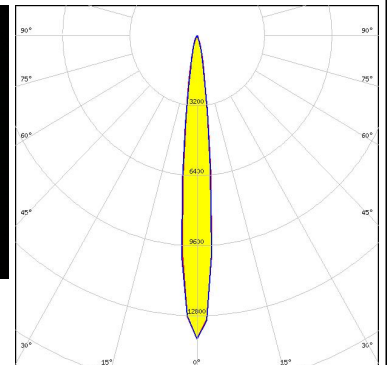

LED NVSxx19B/NVSxx19C
 FWHM / FWTM 12.0° / 26.0°
 Efficiency 92 %
 Peak intensity 13.9 cd/lm
 LEDs/each optic 1
 Light colour White
 Required components:

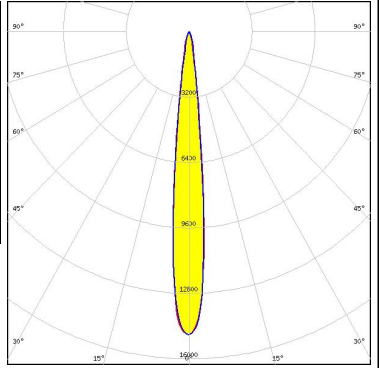

PHOTOMETRIC DATA (MEASURED):

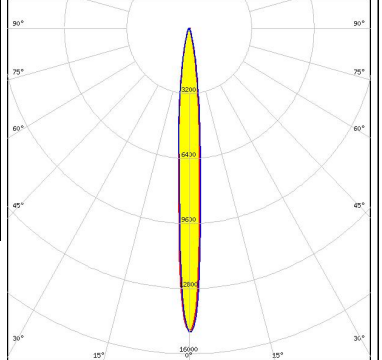
<p>NICHIA</p> <p>LED NVSxx19B/NVSxx19C FWHM / FWTM 12.0° / 21.0° Efficiency 96 % Peak intensity 14.8 cd/lm LEDs/each optic 1 Light colour White Required components:</p>		
<p>OSRAM Opto Semiconductors</p> <p>LED OSLOM Square CSSRM2/CSSRM3 FWHM / FWTM 10.0° / 20.0° Efficiency 89 % Peak intensity 20.8 cd/lm LEDs/each optic 1 Light colour White Required components:</p>		
<p>OSRAM Opto Semiconductors</p> <p>LED OSLOM SSL 150 FWHM / FWTM 7.0° / 16.0° Efficiency 93 % Peak intensity 24.7 cd/lm LEDs/each optic 1 Light colour White Required components:</p>		
<p>SAMSUNG</p> <p>LED LH181A FWHM / FWTM 8.0° / 24.0° Efficiency 94 % Peak intensity 14.9 cd/lm LEDs/each optic 1 Light colour White Required components:</p>		

PHOTOMETRIC DATA (MEASURED):

SAMSUNG

LED LH181B
 FWHM / FWTM 9.0° / 24.0°
 Efficiency 94 %
 Peak intensity 15 cd/lm
 LEDs/each optic 1
 Light colour White
 Required components:

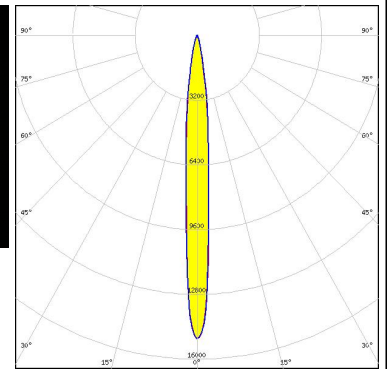

SAMSUNG

LED LH351Z
 FWHM / FWTM 11.0° / 19.0°
 Efficiency 89 %
 Peak intensity 20.7 cd/lm
 LEDs/each optic 1
 Light colour White
 Required components:

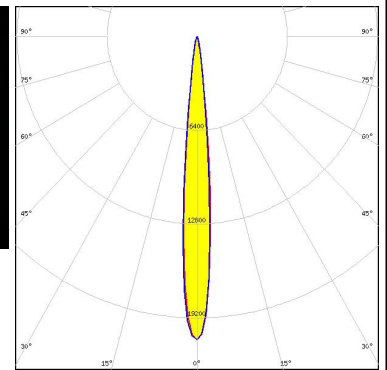

SEOUL SEMICONDUCTOR

LED Z5
 FWHM / FWTM 7.0° / 16.0°
 Efficiency 93 %
 Peak intensity 32.7 cd/lm
 LEDs/each optic 1
 Light colour White
 Required components:



SEOUL SEMICONDUCTOR

LED Z5M1/Z5M2
 FWHM / FWTM 11.0° / 19.0°
 Efficiency 94 %
 Peak intensity 17.8 cd/lm
 LEDs/each optic 1
 Light colour White
 Required components:

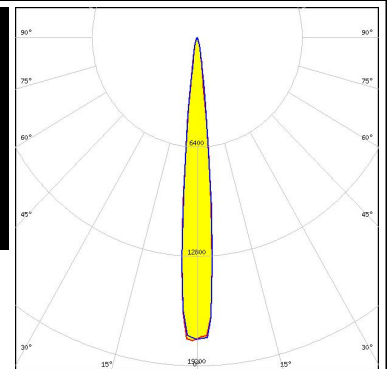
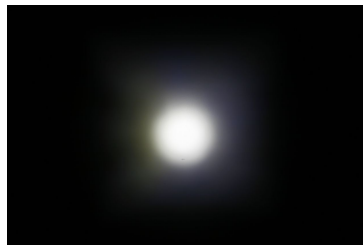

PHOTOMETRIC DATA (SIMULATED):

<p>LUMILEDS</p> <p>LED LUXEON HL2X</p> <p>FWHM / FWTM 14.0° / 26.0°</p> <p>Efficiency 94 %</p> <p>Peak intensity 11.1 cd/lm</p> <p>LEDs/each optic 1</p> <p>Light colour White</p> <p>Required components:</p>	
<p>LUMILEDS</p> <p>LED LUXEON Rubix</p> <p>FWHM / FWTM 6.0° / 14.0°</p> <p>Efficiency 96 %</p> <p>Peak intensity 47.2 cd/lm</p> <p>LEDs/each optic 1</p> <p>Light colour White</p> <p>Required components:</p>	
<p>LUMILEDS</p> <p>LED LUXEON Rubix</p> <p>FWHM / FWTM 6.0° / 14.0°</p> <p>Efficiency 96 %</p> <p>Peak intensity 48.4 cd/lm</p> <p>LEDs/each optic 1</p> <p>Light colour Red</p> <p>Required components:</p>	
<p>LUMILEDS</p> <p>LED LUXEON Rubix</p> <p>FWHM / FWTM 6.0° / 14.0°</p> <p>Efficiency 96 %</p> <p>Peak intensity 46.4 cd/lm</p> <p>LEDs/each optic 1</p> <p>Light colour Green</p> <p>Required components:</p>	

PHOTOMETRIC DATA (SIMULATED):

<p>LUMILEDS</p> <p>LED LUXEON Rubix</p> <p>FWHM / FWTM 6.0° / 14.0°</p> <p>Efficiency 96 %</p> <p>Peak intensity 45.6 cd/lm</p> <p>LEDs/each optic 1</p> <p>Light colour Blue</p> <p>Required components:</p>	
<p>LUMILEDS</p> <p>LED LUXEON SunPlus 20 Line (120 deg)</p> <p>FWHM / FWTM 8.0° / 16.0°</p> <p>Efficiency 96 %</p> <p>Peak intensity 30 cd/lm</p> <p>LEDs/each optic 1</p> <p>Light colour White</p> <p>Required components:</p>	
<p>LUMILEDS</p> <p>LED LUXEON SunPlus 20 Line (150 deg)</p> <p>FWHM / FWTM 8.0° / 17.0°</p> <p>Efficiency 91 %</p> <p>Peak intensity 28.5 cd/lm</p> <p>LEDs/each optic 1</p> <p>Light colour White</p> <p>Required components:</p>	
<p>LUMILEDS</p> <p>LED LUXEON Z ES</p> <p>FWHM / FWTM 7.7° / 17.0°</p> <p>Efficiency 94 %</p> <p>Peak intensity 33.3 cd/lm</p> <p>LEDs/each optic 1</p> <p>Light colour White</p> <p>Required components:</p>	

PHOTOMETRIC DATA (SIMULATED):

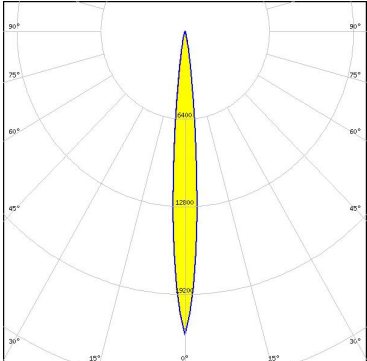
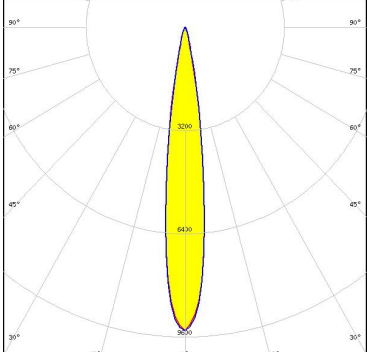
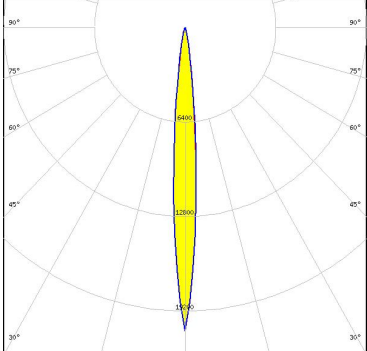
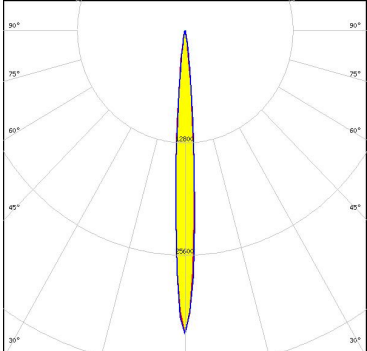
<p>LUMINUS</p> <p>LED SST-20 FWHM / FWTM 10.0° / 19.0° Efficiency 94 % Peak intensity 22.1 cd/lm LEDs/each optic 1 Light colour White Required components:</p>	
<p>NICHIA</p> <p>LED NVSW519A FWHM / FWTM 14.0° / 28.0° Efficiency 92 % Peak intensity 9.4 cd/lm LEDs/each optic 1 Light colour White Required components:</p>	
<p>NICHIA</p> <p>LED NVSxE21A FWHM / FWTM 8.0° / 20.0° Efficiency 93 % Peak intensity 20.6 cd/lm LEDs/each optic 1 Light colour White Required components:</p>	
<p>OSRAM <small>Opto Semiconductors</small></p> <p>LED OSCONIQ P 3030 FWHM / FWTM 7.1° / 16.0° Efficiency 96 % Peak intensity 34.6 cd/lm LEDs/each optic 1 Light colour White Required components:</p>	

PHOTOMETRIC DATA (SIMULATED):

OSRAM

Opto Semiconductors

LED OSLO PURE 1010
 FWHM / FWTM 8.0° / 16.0°
 Efficiency 93 %
 Peak intensity 29.2 cd/lm
 LEDs/each optic 1
 Light colour White
 Required components:

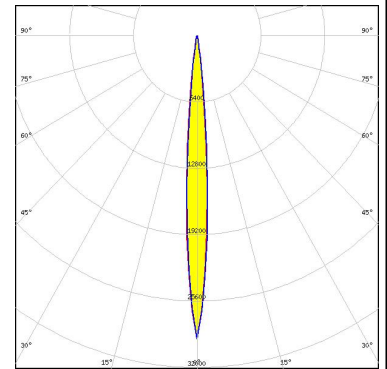

OSRAM

Opto Semiconductors

LED OSLO Square EC
 FWHM / FWTM 12.0°
 Efficiency %
 Peak intensity 11.8 cd/lm
 LEDs/each optic 1
 Light colour White
 Required components:

OSRAM

Opto Semiconductors

LED SFH 4170S
 FWHM / FWTM 6.0° / 14.0°
 Efficiency 88 %
 LEDs/each optic 1
 Light colour IR
 Required components:

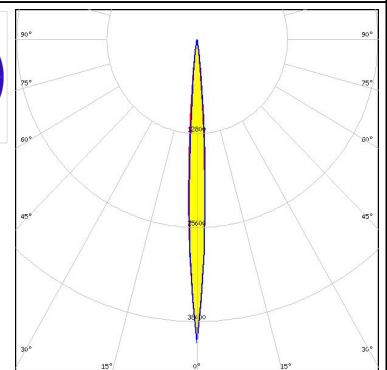
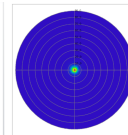
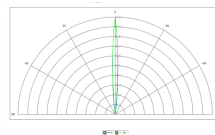

SAMSUNG

LED LH351B
 FWHM / FWTM 12.0° / 22.0°
 Efficiency 94 %
 Peak intensity 14.2 cd/lm
 LEDs/each optic 1
 Light colour White
 Required components:

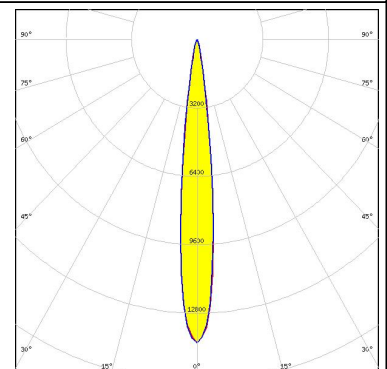

PHOTOMETRIC DATA (SIMULATED):

SAMSUNG

LED	LH351C
FWHM / FWTM	12.0° / 24.0°
Efficiency	95 %
Peak intensity	13.4 cd/lm
LEDs/each optic	1
Light colour	White
Required components:	

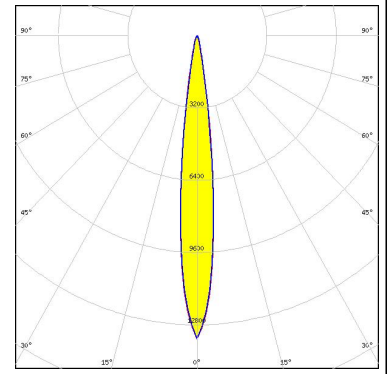

GENERAL INFORMATION:

NOTE: The typical beam angle will be changed by different color, chip size and chip position tolerance. The typical total beam angle is the full angle measured where the luminous intensity is half of the peak value.

MATERIALS:

As part of our continuous research and improvement processes, and to ensure the best possible quality and availability of our products, LEDiL reserves the right to change material grades without notice.

PRODUCT DATA USER AGREEMENT AND DISCLAIMER:

The measured data in the provided downloadable LEDiL Product Datasheets and Mechanical 2D-Drawings is rounded and provided as reference for planning. LEDiL Oy's optical specifications have been verified by conducting performance testing of the products in accordance with the company's quality system. The reported data are averaged results of multiple measurements with typical variation. LEDiL Oy reserves the right to without prior notification make changes and improvements to its products.

LEDiL Oy assumes neither warranty, nor guarantee nor any other liability of any kind for the contents and correctness of the provided data. The provided data has been generated with highest diligence but the provided data may in reality not represent the complete possible variation range of all intrinsic parameters. Therefore, in certain cases a deviation from the provided data could occur.

LEDiL Oy reserves the right to undertake technical changes of its products without further notification which could lead to changes in the provided data. LEDiL Oy assumes no liability of any kind for the possible deviation from any provided data or any other damage resulting from the usage of the provided data.

The user agrees to this disclaimer and user agreement with the download or usage of the provided files.

LEDiL Oy

Joensuunkatu 13
FI-24240 SALO
Finland

LEDiL Inc.

228 West Page Street
Suite D
Sycamore IL 60178
USA

Ledil Optics Technology (Shenzhen) Co., Ltd.

405 , Block B
Casic Motor Building
Shenzhen 518057
P.R.CHINA

Local sales and technical support

[www.ledil.com/
where_to_buy](http://www.ledil.com/where_to_buy)

Shipping locations

Salo, Finland
Hong Kong, China

Distribution Partners

[www.ledil.com/
where_to_buy](http://www.ledil.com/where_to_buy)