

# MMBZxxVxL, SZMMBZxxVxL Series

## Zener Diodes, 40 Watt Peak Power

### SOT-23 Dual Common Cathode Zeners

These dual monolithic silicon zener diodes are designed for applications requiring protection capability. They are intended for use in voltage and ESD sensitive equipment such as computers, printers, business machines, communication systems, medical equipment and other applications. Their dual junction common cathode design protects two separate lines using only one package. These devices are ideal for situations where board space is at a premium.

#### Specification Features:

- SOT-23 Package Allows Either Two Separate Unidirectional Configurations or a Single Bidirectional Configuration
- Standard Zener Breakdown Voltage Range – 15 V, 27 V, 39 V
- Peak Power – 40 W @ 1.0 ms (Bidirectional), per Figure 5 Waveform
- ESD Rating of Class 3B (exceeding 16 kV) per the Human Body Model
- ESD Rating of IEC61000-4-2 Level 4, ±30 kV Contact Discharge
- Low Leakage < 100 nA
- Flammability Rating: UL 94 V-0
- SZ Prefix for Automotive and Other Applications Requiring Unique Site and Control Change Requirements; AEC-Q101 Qualified and PPAP Capable
- These are Pb-Free Devices

#### Mechanical Characteristics:

**CASE:** Void-free, transfer-molded, thermosetting plastic case

**FINISH:** Corrosion resistant finish, easily solderable

**MAXIMUM CASE TEMPERATURE FOR SOLDERING PURPOSES:**  
260°C for 10 Seconds



ON Semiconductor®

[www.onsemi.com](http://www.onsemi.com)

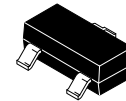

SOT-23  
CASE 318  
STYLE 9

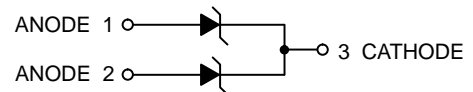

#### MARKING DIAGRAM

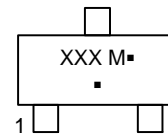

XXX = 15D, 27C or 39C

M = Date Code

▪ = Pb-Free Package

(Note: Microdot may be in either location)

#### ORDERING INFORMATION

Device	Package	Shipping <sup>†</sup>
MMBZ15VDLT1G, SZMMBZ15VDLT1G	SOT-23 (Pb-Free)	3,000 / Tape & Reel
MMBZ15VDLT3G, SZMMBZ15VDLT3G	SOT-23 (Pb-Free)	10,000 / Tape & Reel
MMBZxxVCLT1G, SZMMBZxxVCLT1G	SOT-23 (Pb-Free)	3,000 / Tape & Reel
MMBZxxVCLT3G, SZMMBZxxVCLT3G	SOT-23 (Pb-Free)	10,000 / Tape & Reel

<sup>†</sup>For information on tape and reel specifications, including part orientation and tape sizes, please refer to our Tape and Reel Packaging Specifications Brochure, BRD8011/D.

# MMBZxxVxL, SZMMBZxxVxL Series

## MAXIMUM RATINGS

Rating	Symbol	Value	Unit
Peak Power Dissipation @ 1.0 ms (Note 1) @ $T_L \leq 25^\circ\text{C}$	$P_{pk}$	40	Watts
Total Power Dissipation on FR-5 Board (Note 2) @ $T_A = 25^\circ\text{C}$ Derate above $25^\circ\text{C}$	$P_D$	225 1.8	mW mW/ $^\circ\text{C}$
Thermal Resistance Junction-to-Ambient	$R_{\theta JA}$	556	$^\circ\text{C/W}$
Total Power Dissipation on Alumina Substrate (Note 3) @ $T_A = 25^\circ\text{C}$ Derate above $25^\circ\text{C}$	$P_D$	300 2.4	mW mW/ $^\circ\text{C}$
Thermal Resistance Junction-to-Ambient	$R_{\theta JA}$	417	$^\circ\text{C/W}$
Junction and Storage Temperature Range	$T_J, T_{stg}$	- 55 to +150	$^\circ\text{C}$
Lead Solder Temperature - Maximum (10 Second Duration)	$T_L$	260	$^\circ\text{C}$

Stresses exceeding those listed in the Maximum Ratings table may damage the device. If any of these limits are exceeded, device functionality should not be assumed, damage may occur and reliability may be affected.

1. Nonrepetitive current pulse per Figure 5 and derate above  $T_A = 25^\circ\text{C}$  per Figure 6.
2. FR-5 = 1.0 x 0.75 x 0.62 in.
3. Alumina = 0.4 x 0.3 x 0.024 in., 99.5% alumina

## ELECTRICAL CHARACTERISTICS

( $T_A = 25^\circ\text{C}$  unless otherwise noted)

### UNIDIRECTIONAL (Circuit tied to Pins 1 and 3 or 2 and 3)

Symbol	Parameter
$I_{PP}$	Maximum Reverse Peak Pulse Current
$V_C$	Clamping Voltage @ $I_{PP}$
$V_{RWM}$	Working Peak Reverse Voltage
$I_R$	Maximum Reverse Leakage Current @ $V_{RWM}$
$V_{BR}$	Breakdown Voltage @ $I_T$
$I_T$	Test Current
$V_{BR}$	Maximum Temperature Coefficient of $V_{BR}$
$I_F$	Forward Current
$V_F$	Forward Voltage @ $I_F$

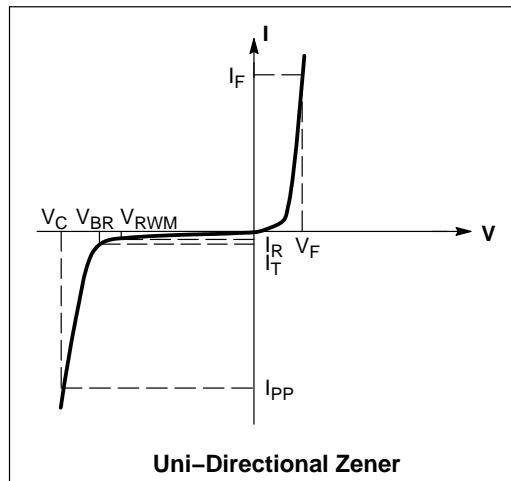

## ELECTRICAL CHARACTERISTICS ( $T_A = 25^\circ\text{C}$ unless otherwise noted)

### UNIDIRECTIONAL (Circuit tied to Pins 1 and 3 or Pins 2 and 3)

( $V_F = 0.9\text{ V Max @ } I_F = 10\text{ mA}$ )

Device*	Device Marking	$V_{RWM}$ Volts	$I_R @ V_{RWM}$ nA	Breakdown Voltage				$V_C @ I_{PP}$ (Note 5)		$V_{BR}$ mV/ $^\circ\text{C}$
				$V_{BR}$ (Note 4) (V)			@ $I_T$	$V_C$ V	$I_{PP}$ A	
				Min	Nom	Max				
MMBZ15VDLT1G/T3G	15D	12.8	100	14.3	15	15.8	1.0	21.2	1.9	12

( $V_F = 1.1\text{ V Max @ } I_F = 200\text{ mA}$ )

Device*	Device Marking	$V_{RWM}$ Volts	$I_R @ V_{RWM}$ nA	Breakdown Voltage				$V_C @ I_{PP}$ (Note 5)		$V_{BR}$ mV/ $^\circ\text{C}$
				$V_{BR}$ (Note 4) (V)			@ $I_T$	$V_C$ V	$I_{PP}$ A	
				Min	Nom	Max				
MMBZ27VCLT1G/T3G	27C	22	50	25.65	27	28.35	1.0	38	1.0	26
MMBZ39VCLT1G/T3G	39C	31.2	50	37.05	39	40.95	1.0	55	0.76	35.3

Product parametric performance is indicated in the Electrical Characteristics for the listed test conditions, unless otherwise noted. Product performance may not be indicated by the Electrical Characteristics if operated under different conditions.

4.  $V_{BR}$  measured at pulse test current  $I_T$  at an ambient temperature of  $25^\circ\text{C}$ .

5. Surge current waveform per Figure 5 and derate per Figure 6

\*Include SZ-prefix devices where applicable.

# MMBZxxVxL, SZMMBZxxVxL Series

## TYPICAL CHARACTERISTICS

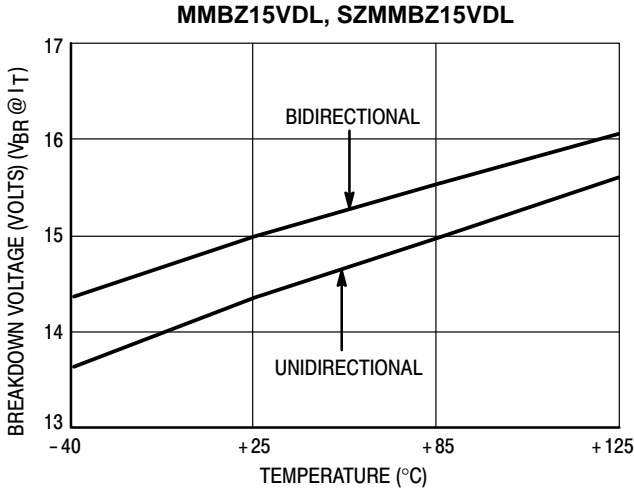

Figure 1. Typical Breakdown Voltage versus Temperature

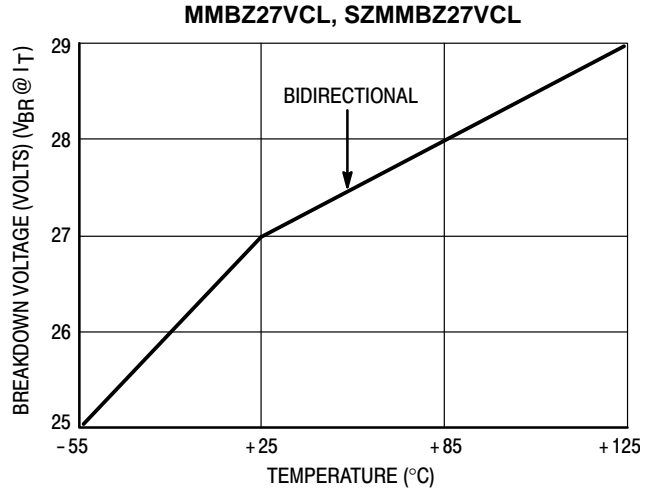

Figure 2. Typical Breakdown Voltage versus Temperature

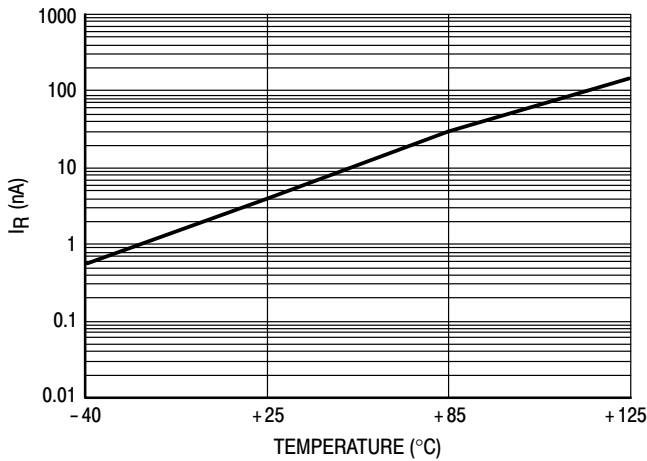

Figure 3. Typical Leakage Current versus Temperature

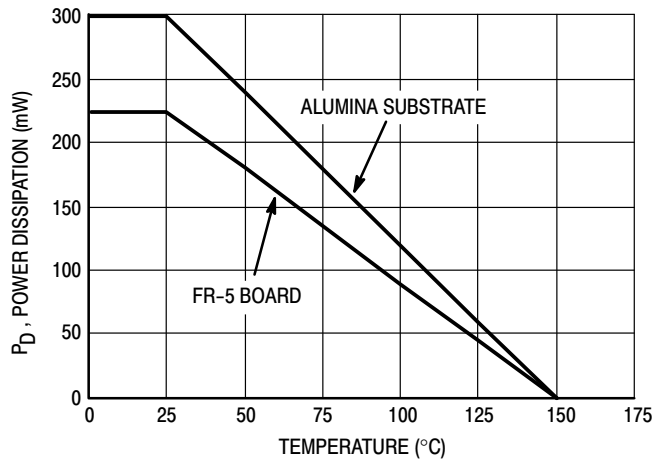

Figure 4. Steady State Power Derating Curve

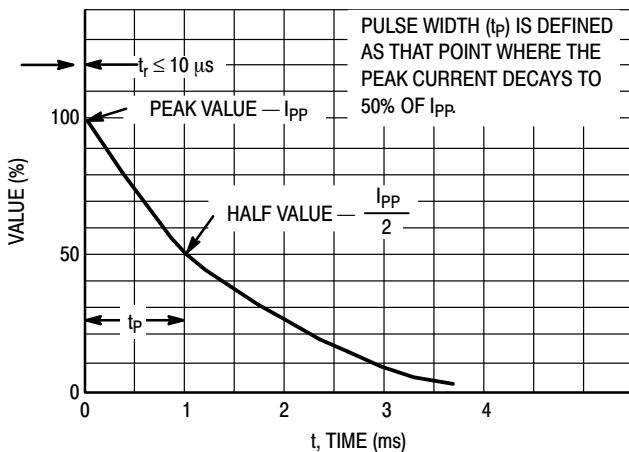

Figure 5. Pulse Waveform

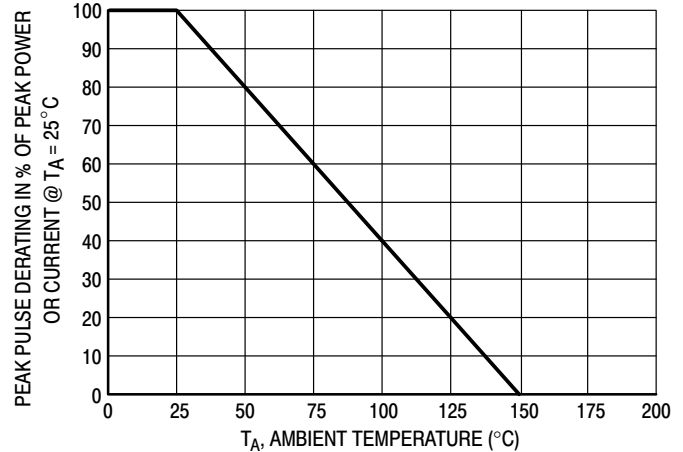
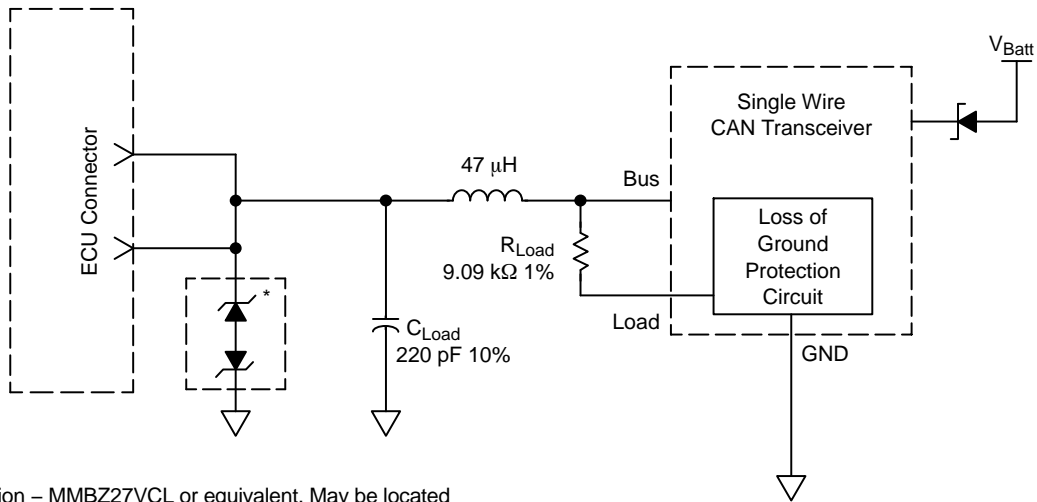

Figure 6. Pulse Derating Curve

# MMBZxxVxL, SZMMBZxxVxL Series

## TYPICAL APPLICATIONS



\*ESD Protection – MMBZ27VCL or equivalent. May be located in each ECU ( $C_{Load}$  needs to be reduced accordingly) or at a central point near the DLC.

**Figure 7. Single Wire CAN Network**

Figure is the recommended solution for transient EMI/ESD protection. This circuit is shown in the Society of Automotive Engineers February, 2000 J2411 “Single Wire CAN Network for Vehicle Applications” specification (Figure 6, page 11). Note: the dual common anode zener configuration shown above is electrically equivalent to a dual common cathode zener configuration.

# MECHANICAL CASE OUTLINE

## PACKAGE DIMENSIONS

ON Semiconductor®



**SOT-23 (TO-236)**  
**CASE 318-08**  
**ISSUE AS**

DATE 30 JAN 2018

SCALE 4:1



**NOTES:**

1. DIMENSIONING AND TOLERANCING PER ASME Y14.5M, 1994.
2. CONTROLLING DIMENSION: MILLIMETERS.
3. MAXIMUM LEAD THICKNESS INCLUDES LEAD FINISH. MINIMUM LEAD THICKNESS IS THE MINIMUM THICKNESS OF THE BASE MATERIAL.
4. DIMENSIONS D AND E DO NOT INCLUDE MOLD FLASH, PROTRUSIONS, OR GATE BURRS.

DIM	MILLIMETERS			INCHES		
	MIN	NOM	MAX	MIN	NOM	MAX
A	0.89	1.00	1.11	0.035	0.039	0.044
A1	0.01	0.06	0.10	0.000	0.002	0.004
b	0.37	0.44	0.50	0.015	0.017	0.020
c	0.08	0.14	0.20	0.003	0.006	0.008
D	2.80	2.90	3.04	0.110	0.114	0.120
E	1.20	1.30	1.40	0.047	0.051	0.055
e	1.78	1.90	2.04	0.070	0.075	0.080
L	0.30	0.43	0.55	0.012	0.017	0.022
L1	0.35	0.54	0.69	0.014	0.021	0.027
HE	2.10	2.40	2.64	0.083	0.094	0.104
T	0°	---	10°	0°	---	10°

**RECOMMENDED  
SOLDERING FOOTPRINT**



**GENERIC  
MARKING DIAGRAM\***



XXX = Specific Device Code  
M = Date Code  
▪ = Pb-Free Package

\*This information is generic. Please refer to device data sheet for actual part marking. Pb-Free indicator, "G" or microdot "▪", may or may not be present.

STYLE 1 THRU 5:  
CANCELLED

STYLE 6:  
PIN 1. BASE  
2. EMITTER  
3. COLLECTOR

STYLE 7:  
PIN 1. EMITTER  
2. BASE  
3. COLLECTOR

STYLE 8:  
PIN 1. ANODE  
2. NO CONNECTION  
3. CATHODE

STYLE 9:  
PIN 1. ANODE  
2. ANODE  
3. CATHODE

STYLE 10:  
PIN 1. DRAIN  
2. SOURCE  
3. GATE

STYLE 11:  
PIN 1. ANODE  
2. CATHODE  
3. CATHODE-ANODE

STYLE 12:  
PIN 1. CATHODE  
2. CATHODE  
3. ANODE

STYLE 13:  
PIN 1. SOURCE  
2. DRAIN  
3. GATE

STYLE 14:  
PIN 1. CATHODE  
2. GATE  
3. ANODE

STYLE 15:  
PIN 1. GATE  
2. CATHODE  
3. ANODE

STYLE 16:  
PIN 1. ANODE  
2. CATHODE  
3. CATHODE

STYLE 17:  
PIN 1. NO CONNECTION  
2. ANODE  
3. CATHODE

STYLE 18:  
PIN 1. NO CONNECTION  
2. CATHODE  
3. ANODE

STYLE 19:  
PIN 1. CATHODE  
2. ANODE  
3. CATHODE-ANODE

STYLE 20:  
PIN 1. CATHODE  
2. ANODE  
3. GATE

STYLE 21:  
PIN 1. GATE  
2. SOURCE  
3. DRAIN

STYLE 22:  
PIN 1. RETURN  
2. OUTPUT  
3. INPUT

STYLE 23:  
PIN 1. ANODE  
2. ANODE  
3. CATHODE

STYLE 24:  
PIN 1. GATE  
2. DRAIN  
3. SOURCE

STYLE 25:  
PIN 1. ANODE  
2. CATHODE  
3. GATE

STYLE 26:  
PIN 1. CATHODE  
2. ANODE  
3. NO CONNECTION

STYLE 27:  
PIN 1. CATHODE  
2. CATHODE  
3. CATHODE

STYLE 28:  
PIN 1. ANODE  
2. ANODE  
3. ANODE

<b>DOCUMENT NUMBER:</b>	<b>98ASB42226B</b>	Electronic versions are uncontrolled except when accessed directly from the Document Repository. Printed versions are uncontrolled except when stamped "CONTROLLED COPY" in red.
<b>DESCRIPTION:</b>	<b>SOT-23 (TO-236)</b>	<b>PAGE 1 OF 1</b>

ON Semiconductor and ON are trademarks of Semiconductor Components Industries, LLC dba ON Semiconductor or its subsidiaries in the United States and/or other countries. ON Semiconductor reserves the right to make changes without further notice to any products herein. ON Semiconductor makes no warranty, representation or guarantee regarding the suitability of its products for any particular purpose, nor does ON Semiconductor assume any liability arising out of the application or use of any product or circuit, and specifically disclaims any and all liability, including without limitation special, consequential or incidental damages. ON Semiconductor does not convey any license under its patent rights nor the rights of others.

**onsemi**, **Onsemi**, and other names, marks, and brands are registered and/or common law trademarks of Semiconductor Components Industries, LLC dba "**onsemi**" or its affiliates and/or subsidiaries in the United States and/or other countries. **onsemi** owns the rights to a number of patents, trademarks, copyrights, trade secrets, and other intellectual property. A listing of **onsemi**'s product/patent coverage may be accessed at [www.onsemi.com/site/pdf/Patent-Marking.pdf](http://www.onsemi.com/site/pdf/Patent-Marking.pdf). **onsemi** reserves the right to make changes at any time to any products or information herein, without notice. The information herein is provided "as-is" and **onsemi** makes no warranty, representation or guarantee regarding the accuracy of the information, product features, availability, functionality, or suitability of its products for any particular purpose, nor does **onsemi** assume any liability arising out of the application or use of any product or circuit, and specifically disclaims any and all liability, including without limitation special, consequential or incidental damages. Buyer is responsible for its products and applications using **onsemi** products, including compliance with all laws, regulations and safety requirements or standards, regardless of any support or applications information provided by **onsemi**. "Typical" parameters which may be provided in **onsemi** data sheets and/or specifications can and do vary in different applications and actual performance may vary over time. All operating parameters, including "Typicals" must be validated for each customer application by customer's technical experts. **onsemi** does not convey any license under any of its intellectual property rights nor the rights of others. **onsemi** products are not designed, intended, or authorized for use as a critical component in life support systems or any FDA Class 3 medical devices or medical devices with a same or similar classification in a foreign jurisdiction or any devices intended for implantation in the human body. Should Buyer purchase or use **onsemi** products for any such unintended or unauthorized application, Buyer shall indemnify and hold **onsemi** and its officers, employees, subsidiaries, affiliates, and distributors harmless against all claims, costs, damages, and expenses, and reasonable attorney fees arising out of, directly or indirectly, any claim of personal injury or death associated with such unintended or unauthorized use, even if such claim alleges that **onsemi** was negligent regarding the design or manufacture of the part. **onsemi** is an Equal Opportunity/Affirmative Action Employer. This literature is subject to all applicable copyright laws and is not for resale in any manner.

## PUBLICATION ORDERING INFORMATION

### LITERATURE FULFILLMENT:

Email Requests to: [orderlit@onsemi.com](mailto:orderlit@onsemi.com)

**onsemi Website:** [www.onsemi.com](http://www.onsemi.com)

### TECHNICAL SUPPORT

**North American Technical Support:**

Voice Mail: 1 800-282-9855 Toll Free USA/Canada

Phone: 011 421 33 790 2910

**Europe, Middle East and Africa Technical Support:**

Phone: 00421 33 790 2910

For additional information, please contact your local Sales Representative