

## Purpose

The RT7236 is a high-performance 650kHz 5A step down regulator with an internal power switch and synchronous rectifier. This document explains the function and use of the RT7236 evaluation board (EVB) and provides information to enable operation and modification of the evaluation board and circuit to suit individual requirements.

## Table of Contents

<i>Purpose</i> .....	1
<i>Introduction</i> .....	2
<i>General Product Information</i> .....	2
<i>Key Performance Summary Table</i> .....	3
<i>Bench Test Setup Conditions</i> .....	4
<i>Headers Description and Placement</i> .....	4
<i>Test Points</i> .....	5
<i>Power-up &amp; Measurement Procedure</i> .....	5
<i>Output Voltage Setting</i> .....	5
<i>Schematic, Bill of Materials and Board Layout</i> .....	6
<i>EVB Schematic Diagram</i> .....	6
<i>Bill of Materials</i> .....	7
<i>EVB Layout</i> .....	8
<i>More Information</i> .....	12
<i>Important Notice for Richtek Evaluation Board</i> .....	12

---

## **Introduction**

### **General Product Information**

#### **General Description**

The RT7236 is a high-performance 650kHz 5A step down regulator with an internal power switch and synchronous rectifier. It features quick transient response using its Advanced Constant On-Time (ACOT™) control architecture that provides stable operation with small ceramic output capacitors and without complicated external compensation, among other benefits. The input voltage range is from 4.5V to 18V and the output is adjustable from 0.765V to 8V. The proprietary ACOT™ control improves upon other fast response constant on-time architectures, achieving nearly constant switching frequency over line, load, and output voltage ranges. Since there is no internal clock, response to transients is nearly instantaneous and inductor current can ramp quickly to maintain output regulation without large bulk output capacitance. The RT7236 is stable with and optimized for ceramic output capacitors.

With its internal 90mΩ switch and 60mΩ synchronous rectifier, the RT7236 displays excellent efficiency and good behavior across a range of applications, especially for low output voltages and low duty cycles. Cycle-by cycle current limit, input under-voltage lock-out, externally-adjustable soft-start, output under- and overvoltage protection, and thermal shutdown provide safe and smooth operation in all operating conditions.

The RT7236 evaluation board uses the RT7236GQW IC in a WDFN-10L3x3 package with an exposed thermal pad. The IC is also available in a PTSSOP-14 package with an exposed thermal pad.

#### **Features**

- Fast Transient Response
- Steady 650kHz Switching Frequency at PWM
- 5A Output Current
- Advanced Constant On-Time (ACOT™) Control
- Optimized for Ceramic Output Capacitors
- 4.5V to 18V Input Voltage Range
- Internal 90mΩ Switch and 60mΩ Synchronous Rectifier
- 0.765V to 8V Adjustable Output Voltage
- Externally-adjustable, Pre-biased Compatible Soft-Start
- Cycle-by-Cycle Current Limit
- Output Over- and Under-voltage Shut-down

*Key Performance Summary Table*

Key features	Evaluation board number: PCB002_V1
Default Input voltage	12V
Max Output Current	5A
Default Output Voltage	1.05V
Default Marking & Package Type	RT7236GQW (WDFN-10L 3x3)
Operation Frequency	Steady 650kHz at PWM
Other Key Features	Advanced constant On-time(ACOT™) control Power Good Adjustable Soft-start (external capacitor) PSM/ PWM Auto Switched
Protection	Over current protection: Cycle-by-Cycle Current Limit Hiccup Mode Output Over- and Under-voltage Shut-down

## **Bench Test Setup Conditions**

### *Headers Description and Placement*

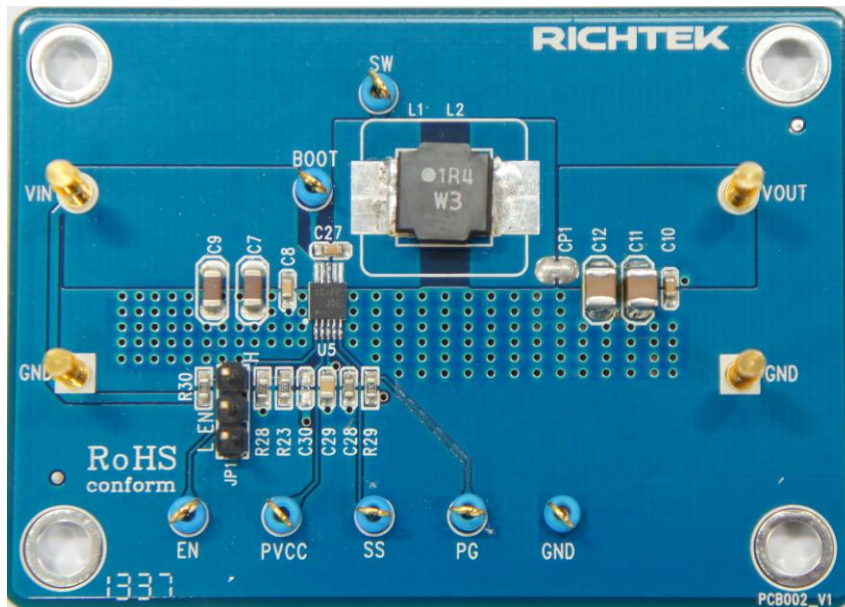

Please carefully inspect the EVB IC and external components, comparing them to the following Bill of Materials, to ensure that all components are installed and undamaged. If any components are missing or damaged during transportation, please contact the distributor or send e-mail to [evb\\_service@richtek.com](mailto:evb_service@richtek.com).

## Test Points

The EVB is provided with the test points and pin names listed in the table below.

Test point/ Pin name	Signal	Comment (expected waveforms or voltage levels on test points)
VIN	Input voltage	Input voltage range = 4.5V to 18V
VOUT	Output voltage	Default output voltage = 1.05V Output voltage range = 0.765V to 8V (see " Output Voltage Setting" section for changing output voltage level)
GND	Ground	Ground reference for the input voltage, output voltage and analog ground
SW	Switching node test point	SW waveform
EN	Enable test point	Enable signal. Drive EN or install a shorting block on Jumper JP1 to enable operation (shorting 2-3) or disable operation (shorting 1-2).
JP1	Chip enable control	Install jumper or drive EN directly to enable or disable operation
BOOT	Boot strap supply test point	Floating supply voltage for the high-side N-MOSFET switch
SS	Soft-start control test point	Soft start waveform
PVCC	Linear regulator output test point	Internal linear regulator output= 5.1V
PG	Power good output test point	Connected to PVCC through R29, PG voltage is 5.1V when soft-start is complete and the output voltage is in regulation

## Power-up & Measurement Procedure

1. Connect a jumper at JP1 terminals 1 and 2, connecting EN to GND, to disable operation.
2. Apply a 12V nominal input power supply ( $4.5V < V_{IN} < 18V$ ) to the VIN and GND terminals.
3. Set the jumper at JP1 to connect terminals 2 and 3, connecting EN to VIN through resistor R30, to enable operation.
4. Verify the output voltage (approximately 1.05V) between VOUT and GND.
5. Connect an external load up to 5A to the VOUT and GND terminals and verify the output voltage and current.

## Output Voltage Setting

Set the output voltage with the resistive divider (R23, R28) between VOUT and GND with the midpoint at FB. The output is set by the following formula:

$$V_{OUT} = 0.765 \times \left(1 + \frac{R23}{R28}\right) \quad V_{OUT} = 0.765 \times \left(1 + \frac{R23}{R28}\right)$$

The installed  $V_{OUT}$  capacitors (C11, C12) are 22 $\mu$ F, 16V X5R ceramic types. Do not exceed their operating voltage range and consider their voltage coefficient (capacitance vs. bias voltage) and ensure that the capacitance is sufficient to maintain stability and provide sufficient transient response for your application. Installing a small 5pF to 22pF capacitor at C30 (in parallel with R23) may be desirable to improve transient response for higher output voltages. See the RT7236 IC datasheet for more information.

## Schematic, Bill of Materials and Board Layout

### EVB Schematic Diagram

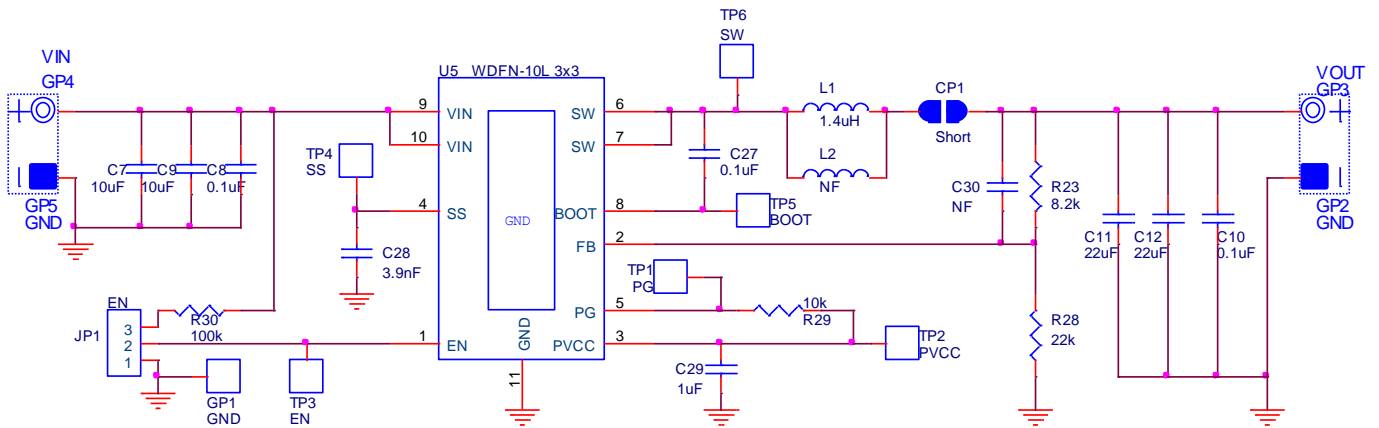

C7, C9: 10 $\mu$ F/50V/X5R, 1206, TDK C3216X5R1H106K

C11, C12: 22 $\mu$ F/16V/X5R, 1210, Murata GRM32ER61C226K

L1: 1.4 $\mu$ H TAIYO YUDEN NR8040T1R4N, DCR=7m $\Omega$

*Bill of Materials*

Reference	Qty	Part number	Description	Package	Manufacture
U5	1	RT7236GQW	DC/DC Converter	WDFN-10L 3x3	Richtek
C7,C9	2	C3216X5R1H106K160AB	10 $\mu$ F/ $\pm$ 10%/50V/X5R Ceramic Capacitor	1206	TDK
C11,C12	2	GRM32ER61C226KE20#	22 $\mu$ F/ $\pm$ 10%/16V/X5R Ceramic Capacitor	1210	Murata
C28	1	0603B392K500	3.9nF/ $\pm$ 10%/50V/X7R Ceramic Capacitor	0603	WALSIN
C8,C10,C27	3	C1608X7R1H104K080AA	0.1 $\mu$ F/ $\pm$ 10%/50V/X7R Ceramic Capacitor	0603	TDK
C29	1	C1608X5R1E105K080AC	1 $\mu$ F/ $\pm$ 10%/25V/X5R Ceramic Capacitor	0603	TDK
C30	0		Not Installed	0603	
L1	1	NR8040T1R4N	1.4 $\mu$ H/7A/ $\pm$ 30%, DCR=7m $\Omega$ , Inductor	8mmx8mmx4mm	TAIYO YUDEN
L2	0		Not Installed		
R28	1		22k/ $\pm$ 5%, Resistor	0603	
R23	1		8.2k/ $\pm$ 5%, Resistor	0603	
R29	1		10k/ $\pm$ 5%, Resistor	0603	
R30	1		100k/ $\pm$ 5%, Resistor	0603	
CP1	1		0 (Short)		
JP1	1		3-Pin Header		
TP1/2/3/4/5/6	6		Test Pin		
GP	5		Golden Pin		

*EVB Layout*

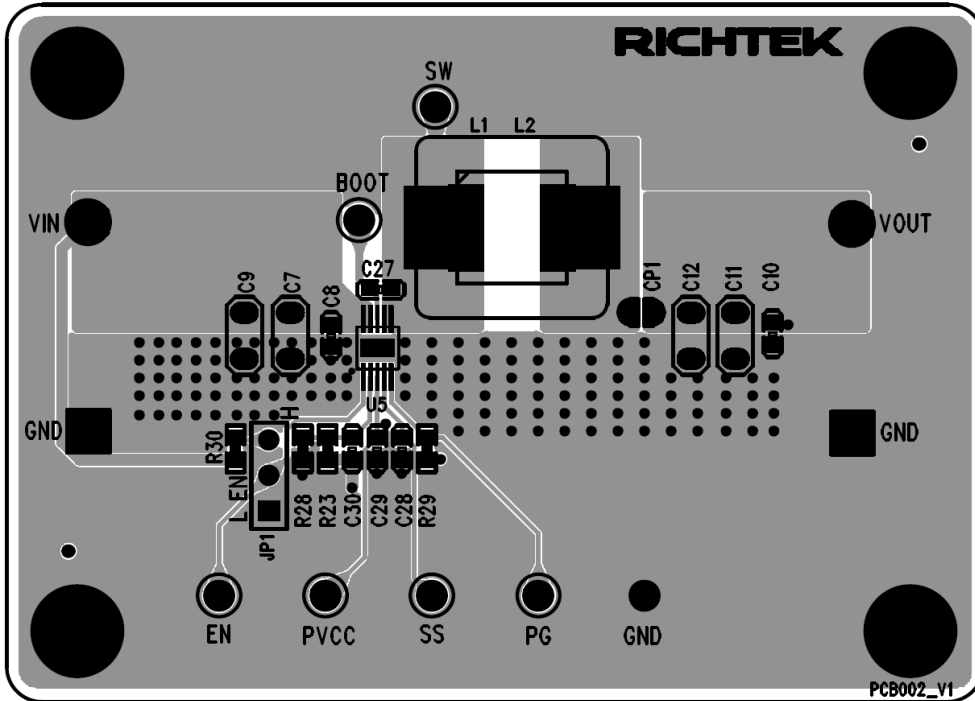

Top View (1<sup>st</sup> layer)

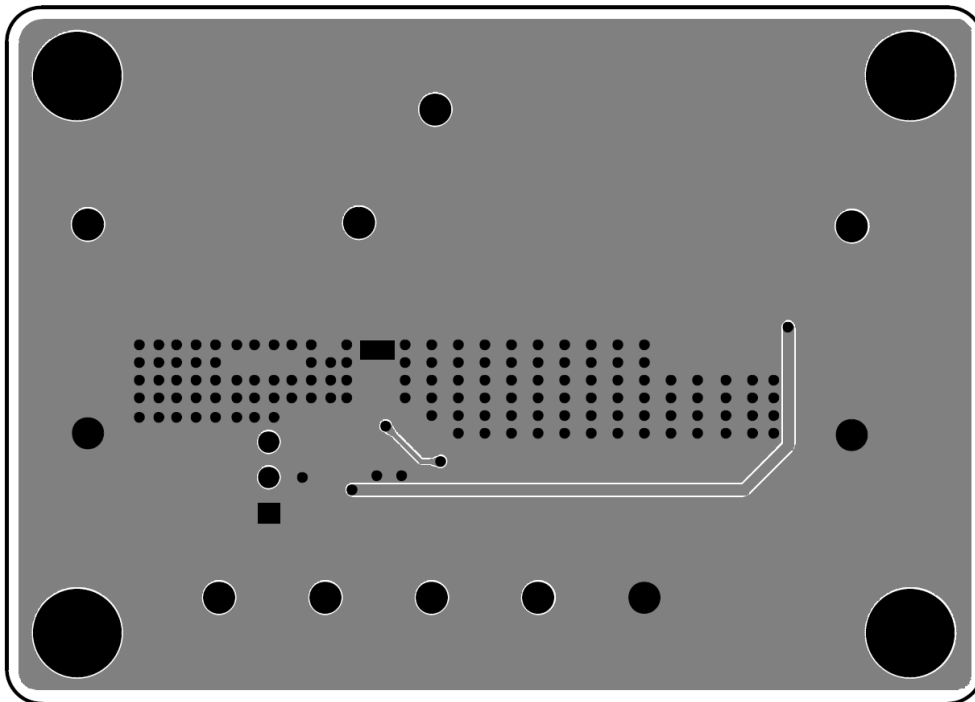

Bottom View (4<sup>th</sup> Layer)



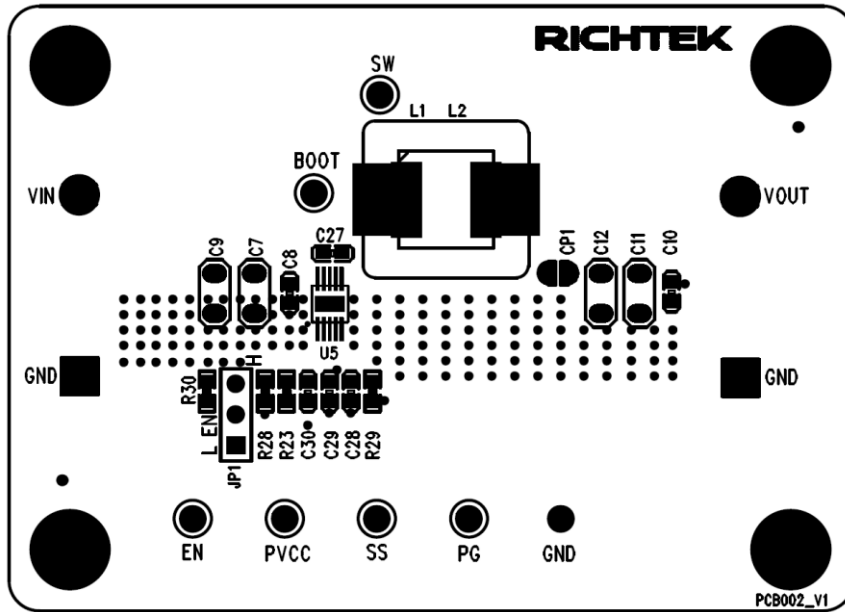

Component Placement Guide—Component Side (1<sup>st</sup> layer)

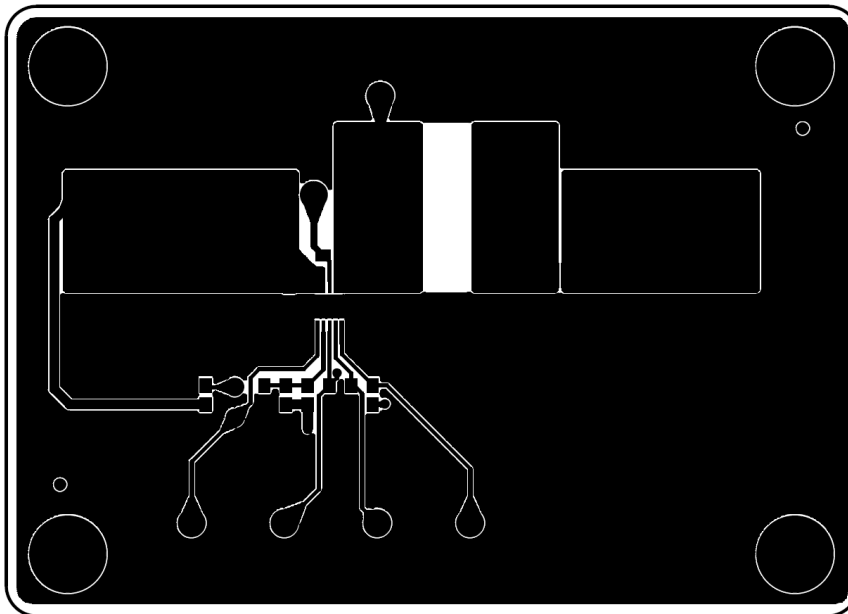

PCB Layout—Component Side (1<sup>st</sup> Layer)

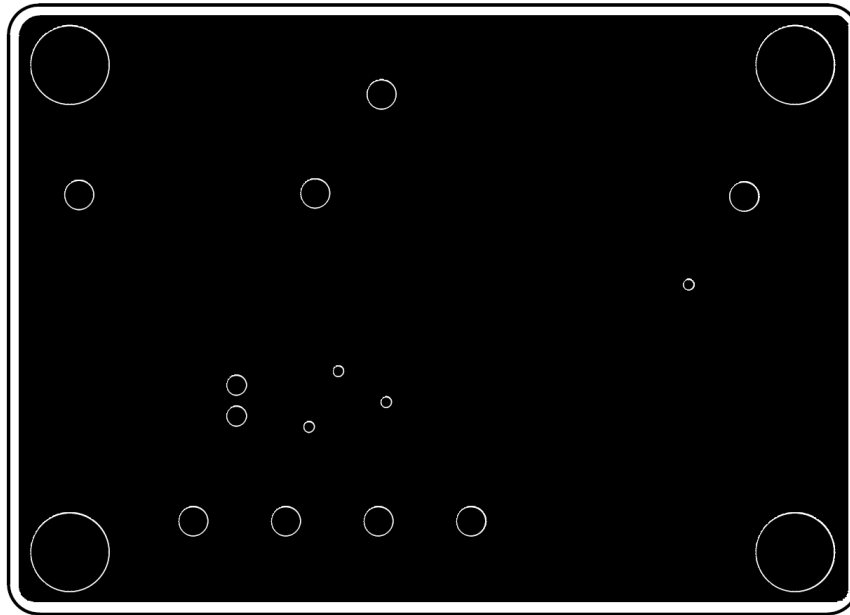

PCB Layout—Inner Side (2<sup>nd</sup> Layer)

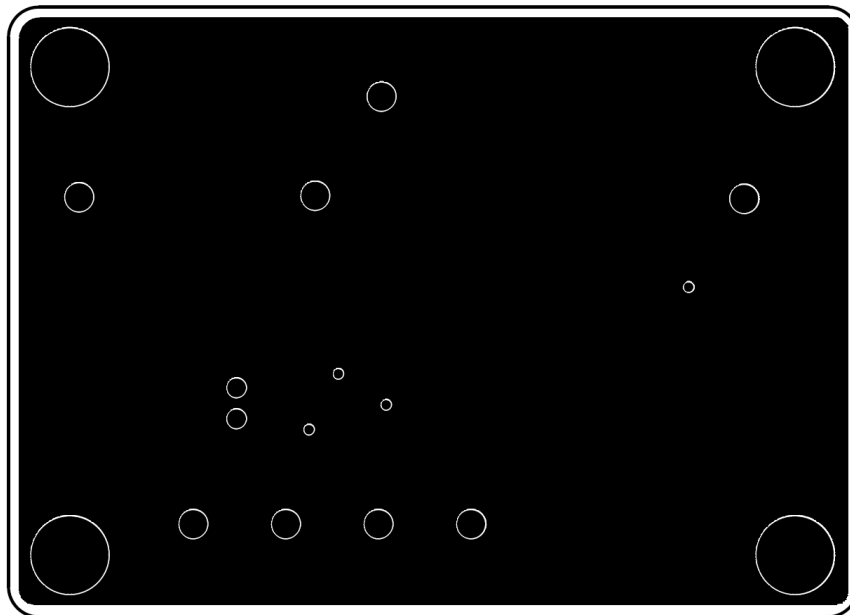

PCB Layout—Inner Side (3<sup>rd</sup> Layer)

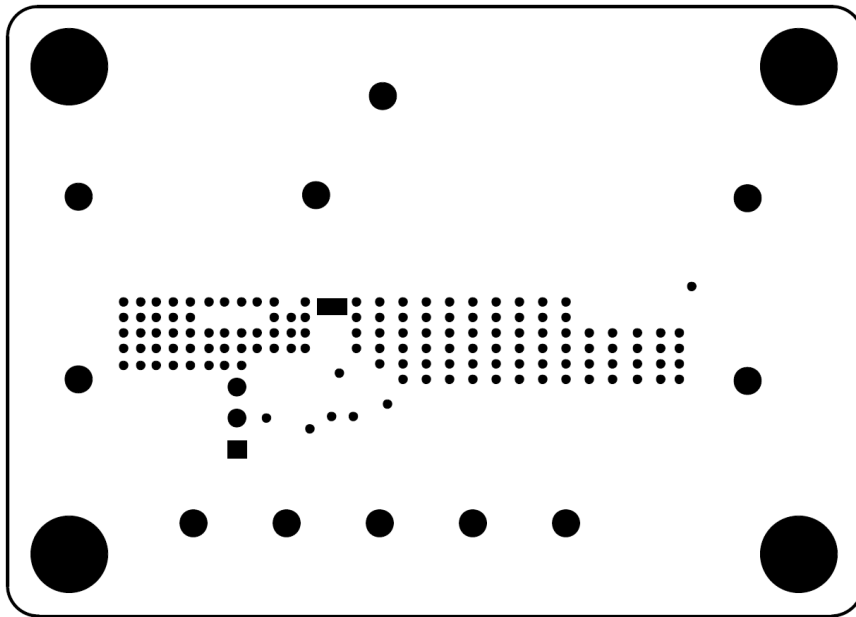

Component Placement Guide—Bottom Side (4<sup>th</sup> Layer)

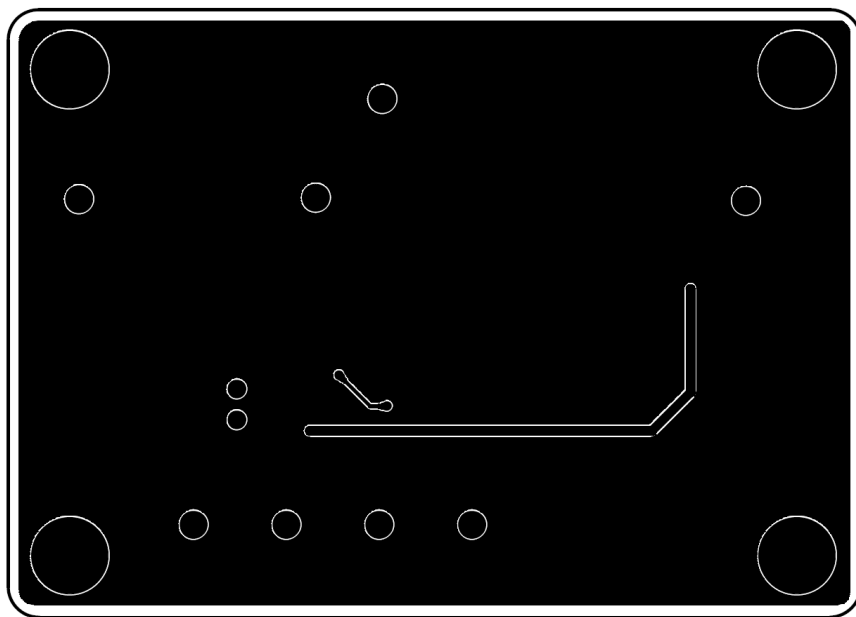

PCB Layout—Bottom Side (4<sup>th</sup> layer)

### ***More Information***

For more information, please find the related datasheet or application notes from Richtek website <http://www.richtek.com>.

### ***Important Notice for Richtek Evaluation Board***

THIS DOCUMENT IS FOR REFERENCE ONLY, NOTHING CONTAINED IN THIS DOCUMENT SHALL BE CONSTRUED AS RICHTEK'S WARRANTY, EXPRESS OR IMPLIED, UNDER CONTRACT, TORT OR STATUTORY, WITH RESPECT TO THE PRESENTATION HEREIN. IN NO EVENT SHALL RICHTEK BE LIABLE TO BUYER OR USER FOR ANY AND ALL DAMAGES INCLUDING WITHOUT LIMITATION TO DIRECT, INDIRECT, SPECIAL, PUNITIVE OR CONSEQUENTIAL DAMAGES.