

SERIES: PDSE1-S | **DESCRIPTION:** DC-DC CONVERTER**FEATURES**

- 1 W isolated output
- unregulated output
- compact SIP package
- single output models
- continuous short circuit protection
- extended temperature range (-40~105°C)
- 1500 Vdc isolation
- no load input current as low as 5 mA
- UL 62368 approval
- efficiency up to 85%
- EN 62368-1

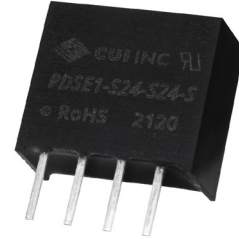

MODEL	input voltage		output voltage (Vdc)	output current		output power max (W)	ripple & noise ¹ max (mVp-p)	efficiency ² typ (%)
	typ (Vdc)	range (Vdc)		min (mA)	max (mA)			
PDSE1-S5-S3-S	5	4.5~5.5	3.3	30	303	1	75	74
PDSE1-S5-S5-S	5	4.5~5.5	5	20	200	1	75	82
PDSE1-S5-S9-S	5	4.5~5.5	9	12	111	1	75	83
PDSE1-S5-S12-S	5	4.5~5.5	12	9	84	1	75	83
PDSE1-S5-S15-S	5	4.5~5.5	15	7	67	1	75	83
PDSE1-S5-S24-S	5	4.5~5.5	24	4	42	1	100	85
PDSE1-S12-S3-S	12	10.8~13.2	3.3	30	303	1	75	75
PDSE1-S12-S5-S	12	10.8~13.2	5	20	200	1	75	80
PDSE1-S12-S9-S	12	10.8~13.2	9	12	111	1	75	80
PDSE1-S12-S12-S	12	10.8~13.2	12	9	83	1	75	80
PDSE1-S12-S15-S	12	10.8~13.2	15	7	67	1	75	81
PDSE1-S12-S24-S	12	10.8~13.2	24	5	42	1	100	81
PDSE1-S15-S5-S	15	13.5~16.5	5	20	200	1	75	80
PDSE1-S15-S9-S	15	13.5~16.5	9	12	111	1	75	80
PDSE1-S15-S12-S	15	13.5~16.5	12	9	83	1	75	80
PDSE1-S15-S15-S	15	13.5~16.5	15	7	67	1	75	81
PDSE1-S15-S24-S ⁴	15	13.5~16.5	24	5	42	1	100	81
PDSE1-S24-S3-S	24	21.6~26.4	3.3	30	303	1	75	75
PDSE1-S24-S5-S	24	21.6~26.4	5	20	200	1	75	79
PDSE1-S24-S9-S	24	21.6~26.4	9	12	111	1	75	80
PDSE1-S24-S12-S	24	21.6~26.4	12	9	83	1	75	81
PDSE1-S24-S15-S	24	21.6~26.4	15	7	67	1	75	81
PDSE1-S24-S24-S	24	21.6~26.4	24	5	42	1	100	81

Notes: 1. Measured at nominal input, 20 MHz bandwidth oscilloscope, with 10 μ F tantalum and 1 μ F ceramic capacitors on the output.
 2. Measured at nominal input voltage, full load.
 3. All specifications are measured at $T_a=25^\circ\text{C}$, humidity < 75%, nominal input voltage, and rated output load unless otherwise specified.
 4. Model is not UL or CE certified.

PART NUMBER KEY

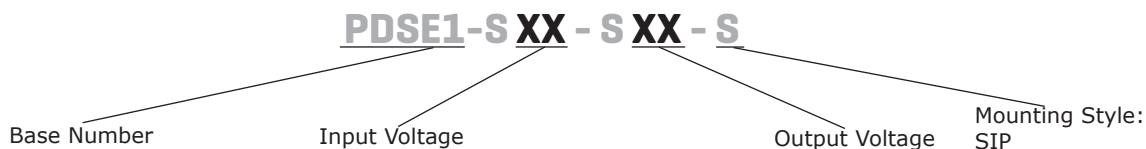

INPUT

parameter	conditions/description	min	typ	max	units	
operating input voltage	5 Vdc input models	4.5	5	5.5	Vdc	
	12 Vdc input models	10.8	12	13.2	Vdc	
	15 Vdc input models	13.5	15	16.5	Vdc	
	24 Vdc input models	21.6	24	26.4	Vdc	
surge voltage	for maximum of 1 second					
	5 Vdc input models	-0.7		9	Vdc	
	12 Vdc input models	-0.7		18	Vdc	
	15 Vdc input models	-0.7		21	Vdc	
current	5 Vdc input models			3.3, 5 Vdc output models	286	mA
				9, 12 Vdc output models	254	mA
				all other output models	254	mA
	12 Vdc input models				3.3 Vdc output models	118
15 Vdc input models				5, 9, 12 Vdc output models	110	mA
				all other output models	109	mA
24 Vdc input models				5, 9, 12 Vdc output models	88	mA
				all other output models	87	mA
				3.3 Vdc output models	61	mA
				5 Vdc output models	58	mA
9 Vdc output models				9 Vdc output models	57	mA
				all other output models	56	mA
filter	filter capacitor					

OUTPUT

parameter	conditions/description	min	typ	max	units	
maximum capacitive load ⁴				3.3, 5 Vdc output models	2,400	μF
				9 Vdc output models	1,000	μF
				12, 15 Vdc output models	560	μF
				all other models	220	μF
voltage accuracy	see tolerance envelope curves					
line regulation	for Vin change of 1%			3.3 Vdc output models	±1.5	%
				all other models	±1.2	%
load regulation	from 10% to full load			3.3 Vdc output models	±20	%
				5 Vdc output models	±15	%
				all other models	±10	%
switching frequency	100% load, nominal input voltage		270		kHz	
temperature coefficient	at full load		±0.02		%/°C	

Note: 4. Tested at input voltage range and full load.

PROTECTIONS

parameter	conditions/description	min	typ	max	units
short circuit protection	continuous, self recovery				

SAFETY AND COMPLIANCE

parameter	conditions/description	min	typ	max	units
isolation voltage	input to output for 1 minute at 1 mA	1,500			Vdc
	input to output for 1 second at 1 mA	3,000			Vdc
isolation resistance	input to output at 500 Vdc	1,000			MΩ
isolation capacitance	input to output, 100 kHz / 0.1 V		20		pF
safety approvals	certified to 62368-1: EN, UL				
conducted emissions	CISPR32/EN55032, class B (external circuit required, see Figure 2)				
radiated emissions	CISPR32/EN55032, class B (external circuit required, see Figure 2)				
ESD	IEC/EN61000-4-2, air ± 8 kV; contact ± 4 kV, class B				
MTBF	as per MIL-HDBK-217F, 25°C	3,500,000			hours
RoHS	yes				

ENVIRONMENTAL

parameter	conditions/description	min	typ	max	units
operating temperature	see derating curves	-40		105	°C
storage temperature		-55		125	°C
storage humidity	non-condensing			95	%
case temperature rise	3.3 Vdc output model at 25°C		25		°C
	all other models at 25°C		15		°C

DERATING CURVES

TEMPERATURE DERATING CURVE

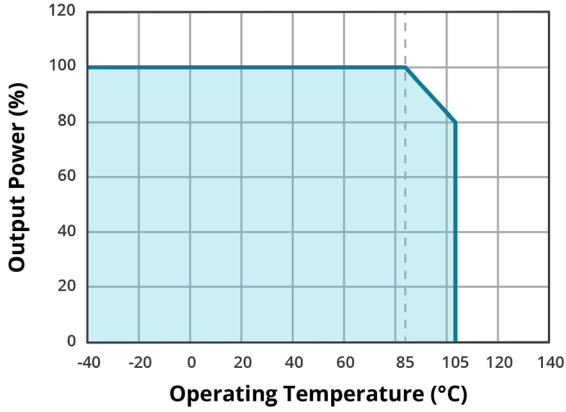

**OUTPUT REGULATION CURVE
3.3 Vdc output models
(nominal input)**

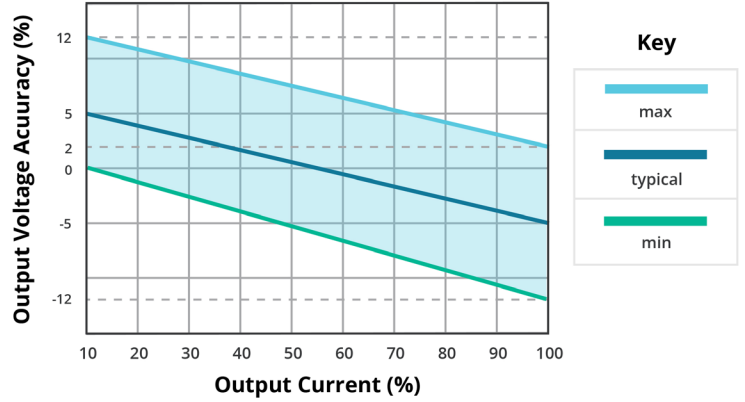

**OUTPUT REGULATION CURVE
5 Vdc input model / 5, 9, 12, 15, 24 Vdc output models
(nominal input)**

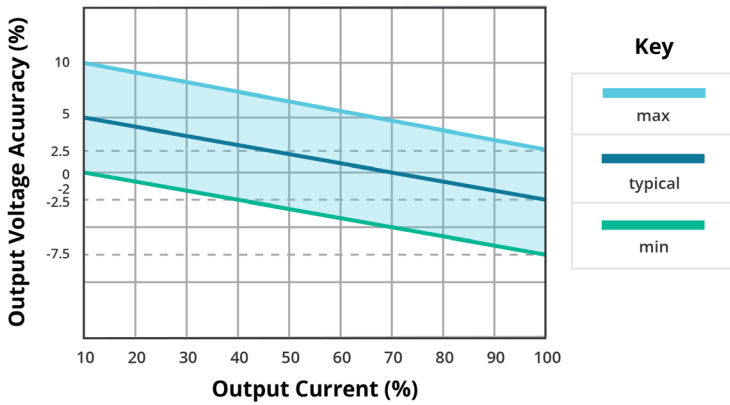

**OUTPUT REGULATION CURVE
all other input models / 5, 9, 12, 15, 24 Vdc output models
(nominal input)**

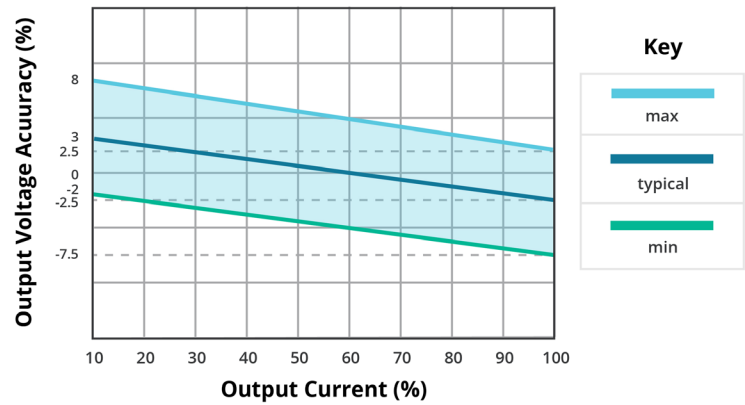

SOLDERABILITY

parameter	conditions/description	min	typ	max	units
hand soldering	1.5 mm from case for 10 seconds			300	°C
wave soldering	see wave soldering profile			260	°C

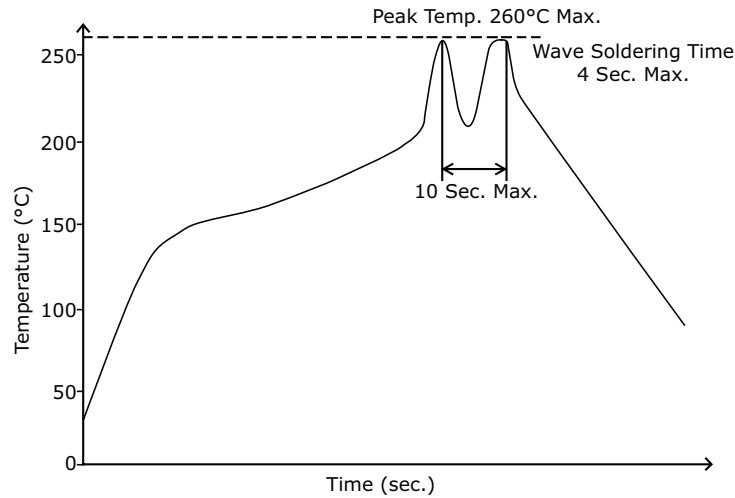

MECHANICAL

parameter	conditions/description	min	typ	max	units
dimensions	11.60 x 6.00 x 10.16 [0.457 x 0.236 x 0.400 inch]				mm
case material	black flame-retardant and heat-resistant plastic (UL94V-0)				
weight			1.3		g

MECHANICAL DRAWING

units: mm [inch]
tolerance: ± 0.25 [± 0.010]
pin section tolerance: ± 0.10 [± 0.004]

PIN CONNECTIONS	
PIN	Function
1	GND
2	V _{in}
3	0V
4	+V _{out}

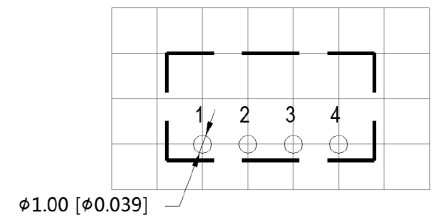
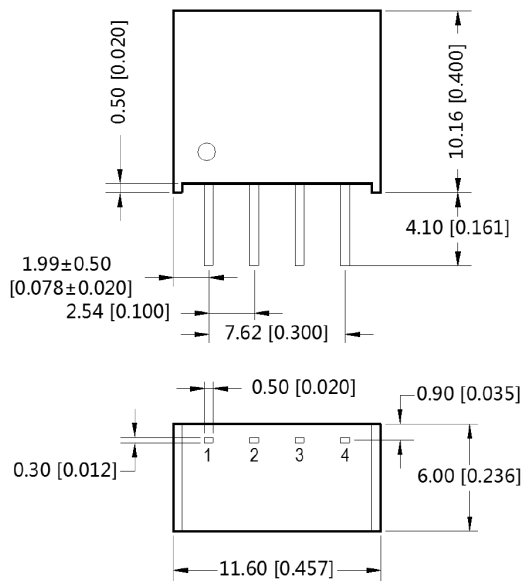

Note : Grid 2.54*2.54mm
Recommended PCB Layout
Top View

APPLICATION CIRCUIT

If you want to further reduce the input and output ripple, a filter capacitor may be connected to the input and output terminals (Figure 1) provided that the capacitance is less than the maximum capacitive load of the model, otherwise start-up problems may be caused if the capacitance is too large.

Figure 1

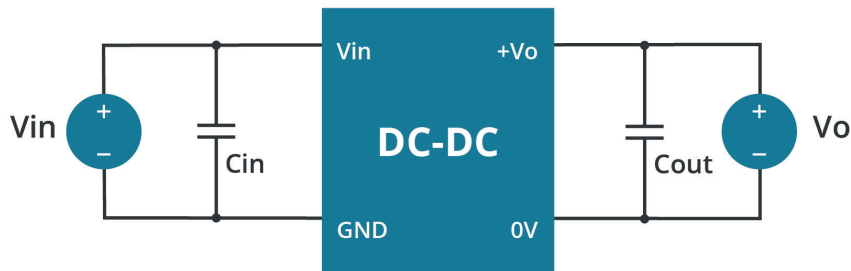

Table 1

Vin (Vdc)	Cin (μF/V)	Vo (Vdc)	Cout (μF/V)
5	4.7	3.3, 5	10
		9, 12	2.2
		15, 24	1
12	2.2/25	3.3	10/16
15	2.2/25	5	10/16
24	1/50	9	2.2/16
--	--	12	2.2/25
--	--	15	1/25
--	--	24	1/50

EMC RECOMMENDED CIRCUIT

Figure 2

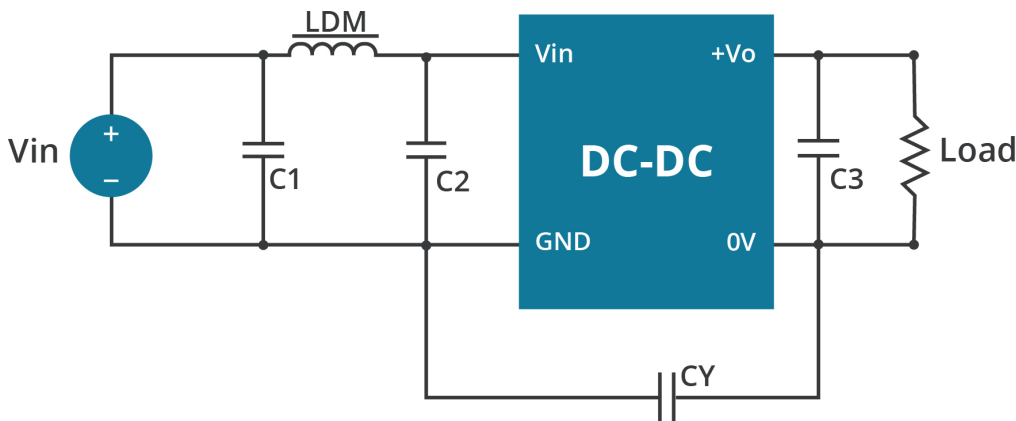

Table 2

Recommended External Circuit Components			
Vin (Vdc)	Vo (Vdc)	3.3, 5, 9	12, 15, 24
5	CY	--	1 nF / 4kVdc
	C3	refer to the Cout in Table 1	
	C1, C2	4.7 μF / 25 V	4.7 μF / 25 V
	LDM	6.8 μH	6.8 μH
12, 15, 24	C1	4.7 μF / 50 V	4.7 μF / 50 V
	C2	4.7 μF / 50 V	4.7 μF / 50 V
	C3	refer to the Cout in Table 1	
	LDM	6.8 μH	6.8 μH
	CY	270 pF / 2 kV	270 pF / 2 kV

REVISION HISTORY

rev.	description	date
1.0	initial release	05/10/2019
1.01	safeties updated in features and safety line, packaging removed	01/18/2021
1.02	datasheet updated	06/21/2021

The revision history provided is for informational purposes only and is believed to be accurate.



CUI INC

a bel group

Headquarters
20050 SW 112th Ave.
Tualatin, OR 97062
800.275.4899

Fax 503.612.2383
cui.com
techsupport@cui.com

CUI offers a two (2) year limited warranty. Complete warranty information is listed on our website.

CUI reserves the right to make changes to the product at any time without notice. Information provided by CUI is believed to be accurate and reliable. However, no responsibility is assumed by CUI for its use, nor for any infringements of patents or other rights of third parties which may result from its use.

CUI products are not authorized or warranted for use as critical components in equipment that requires an extremely high level of reliability. A critical component is any component of a life support device or system whose failure to perform can be reasonably expected to cause the failure of the life support device or system, or to affect its safety or effectiveness.