

LISA2-R-PIN

White mini reflector with ~80° wide beam. 6.5 mm high with location pin installation.

TECHNICAL SPECIFICATIONS:

Dimensions	Ø 9.9 mm
Height	6.5 mm
Fastening	glue, pin
ROHS compliant	yes ⓘ

MATERIAL SPECIFICATIONS:

Component	Type	Material	Colour	Finish	Coating
LISA2-R-PIN	Reflector	HRPC	white		

ORDERING INFORMATION:

Component	Qty in box	MOQ	MPQ	Box weight (kg)
C12469_LISA2-R-PIN » Box size: 254 x 298 x 241 mm	10000	300	100	4.1



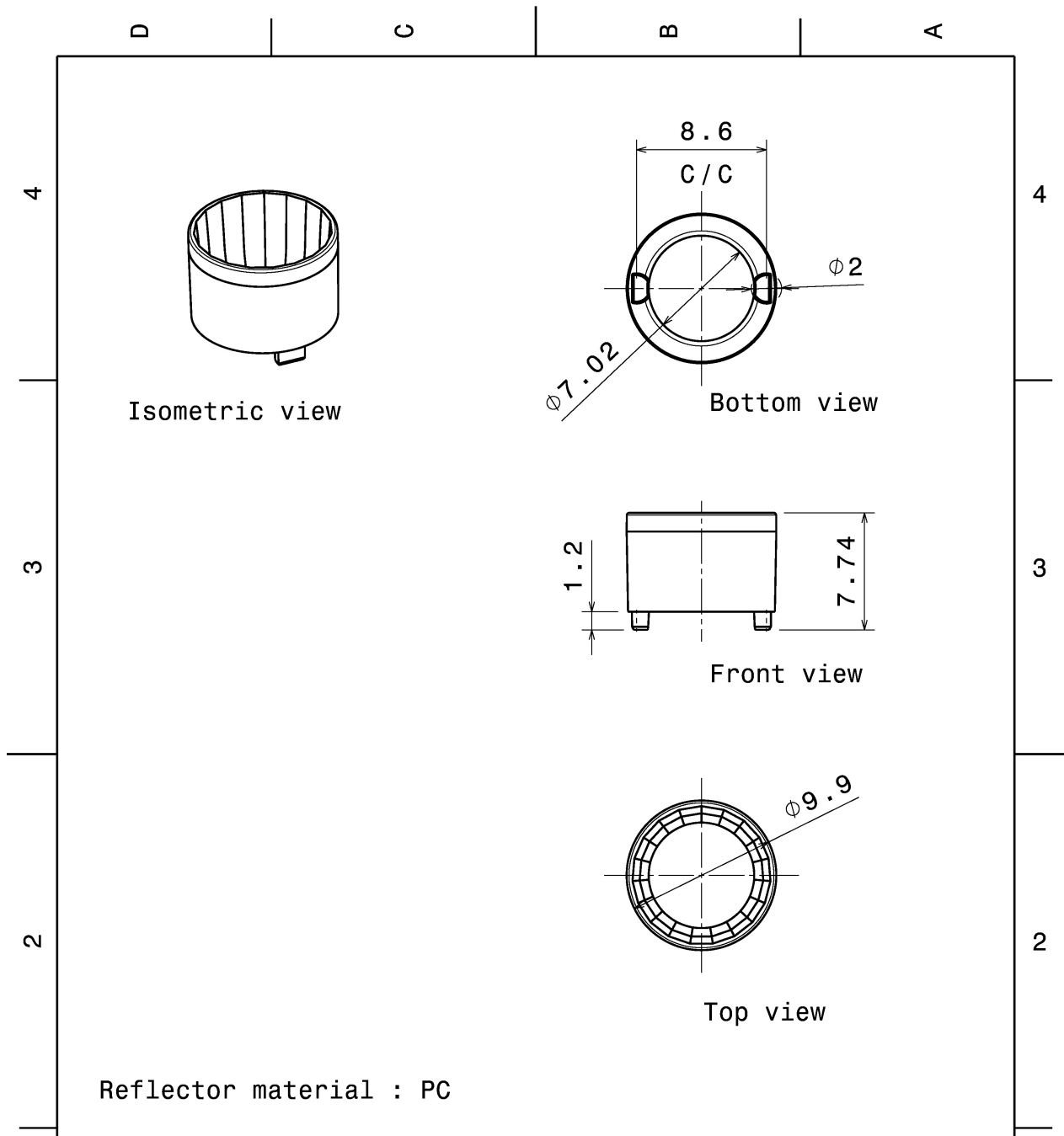

Reflector material : PC

Tolerances if not otherwise shown
According to DIN ISO 2768-1
Linear measures:
Up to 30mm class M, otherwise class C.
According to DIN ISO 2768-2
Form and position: class L

LEDiL Ledil Oy
Salorankatu 10
FIN 24240 SALO
Finland

THIRD ANGLE PROJECTION:

DRAWING TITLE
Datasheet_Lisa2-reflector

This drawing is the property of LEDiL Oy. It may not be reproduced, copied or communicated without a written agreement with LEDiL Oy."

SIZE	PART NUMBER
A4	-

SCALE	3:1	WEIGHT	-	SHEET	1/1
-------	-----	--------	---	-------	-----

See also our general installation guide: www.ledil.com/installation_guide

PHOTOMETRIC DATA (MEASURED):

CREE LED

LED XB-D
 FWHM / FWTM 81.0° / 148.0°
 Efficiency 87 %
 Peak intensity 0.4 cd/lm
 LEDs/each optic 1
 Light colour White
 Required components:

CREE LED

LED XP-E
 FWHM / FWTM 82.0° / 152.0°
 Efficiency 86 %
 Peak intensity 0.4 cd/lm
 LEDs/each optic 1
 Light colour White
 Required components:

CREE LED

LED XP-G
 FWHM / FWTM 86.0° / 154.0°
 Efficiency 89 %
 Peak intensity 0.3 cd/lm
 LEDs/each optic 1
 Light colour White
 Required components:

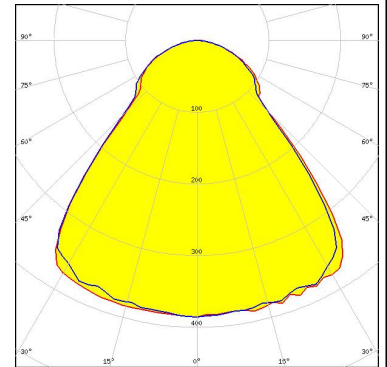

CREE LED

LED XP-G3
 FWHM / FWTM 86.0° / 152.0°
 Efficiency 88 %
 Peak intensity 0.4 cd/lm
 LEDs/each optic 1
 Light colour White
 Required components:

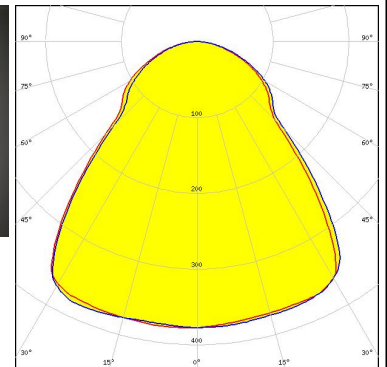
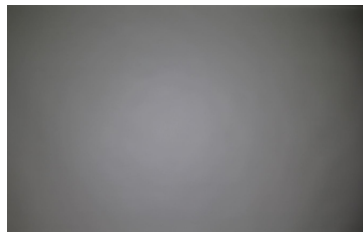

PHOTOMETRIC DATA (MEASURED):



LED XT-E
 FWHM / FWTM 80.0° / 144.0°
 Efficiency 85 %
 Peak intensity 0.5 cd/lm
 LEDs/each optic 1
 Light colour White
 Required components:

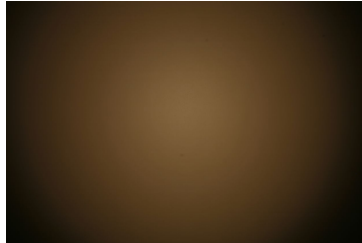

LED LUXEON A
 FWHM / FWTM 83.0° / 152.0°
 Efficiency 88 %
 Peak intensity 0.4 cd/lm
 LEDs/each optic 1
 Light colour White
 Required components:



LED LUXEON C
 FWHM / FWTM 84.0° / 154.0°
 Efficiency 83 %
 Peak intensity 0.4 cd/lm
 LEDs/each optic 1
 Light colour White
 Required components:



LED LUXEON Rebel
 FWHM / FWTM 77.0° / 144.0°
 Efficiency 88 %
 Peak intensity 0.4 cd/lm
 LEDs/each optic 1
 Light colour White
 Required components:

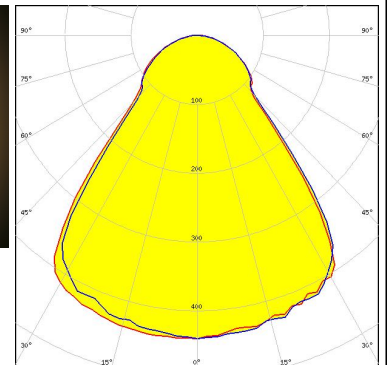
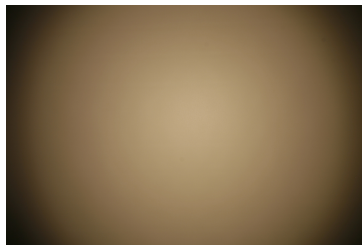

PHOTOMETRIC DATA (MEASURED):

LUMILEDS

LED LUXEON Rebel ES
 FWHM / FWTM 83.0° / 152.0°
 Efficiency 90 %
 Peak intensity 0.4 cd/lm
 LEDs/each optic 1
 Light colour White
 Required components:

LUMILEDS

LED LUXEON T
 FWHM / FWTM 82.0° / 148.0°
 Efficiency 82 %
 Peak intensity 0.4 cd/lm
 LEDs/each optic 1
 Light colour White
 Required components:

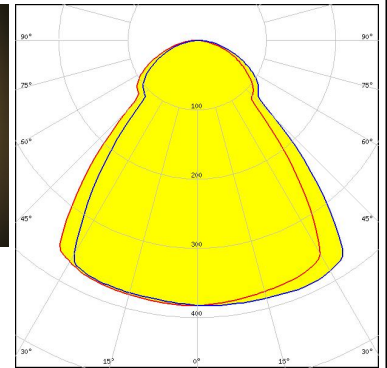
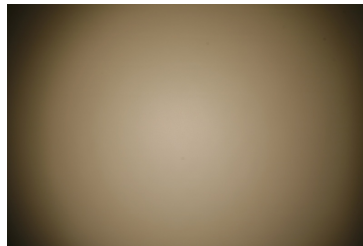

LUMILEDS

LED LUXEON Z
 FWHM / FWTM 78.0° / 146.0°
 Efficiency 86 %
 Peak intensity 0.4 cd/lm
 LEDs/each optic 1
 Light colour White
 Required components:



NICHIA

LED NCSxx19A
 FWHM / FWTM 78.0° / 146.0°
 Efficiency 84 %
 Peak intensity 0.5 cd/lm
 LEDs/each optic 1
 Light colour White
 Required components:

PHOTOMETRIC DATA (MEASURED):



LED NVSxx19A
 FWHM / FWTM 80.0° / 148.0°
 Efficiency 84 %
 Peak intensity 0.4 cd/lm
 LEDs/each optic 1
 Light colour White
 Required components:



LED OSCONIQ P 2226
 FWHM / FWTM 78.0° / 147.0°
 Efficiency 83 %
 Peak intensity 0.4 cd/lm
 LEDs/each optic 1
 Light colour White
 Required components:

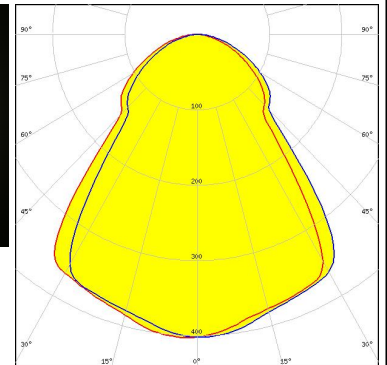
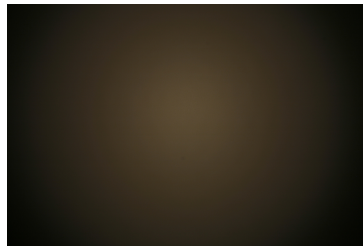

LED OSLOM Square EC
 FWHM / FWTM 82.0° / 152.0°
 Efficiency 85 %
 Peak intensity 0.4 cd/lm
 LEDs/each optic 1
 Light colour White
 Required components:

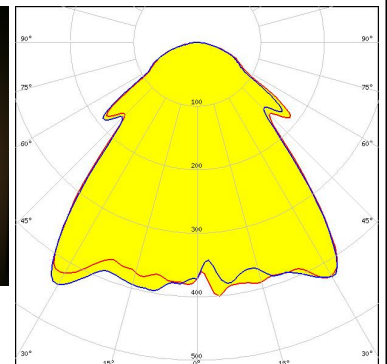
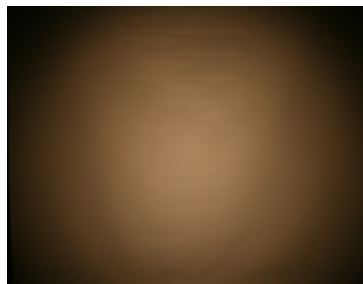

LED OSLOM SSL 150
 FWHM / FWTM 83.0° / 156.0°
 Efficiency 91 %
 Peak intensity 0.3 cd/lm
 LEDs/each optic 1
 Light colour White
 Required components:

PHOTOMETRIC DATA (MEASURED):

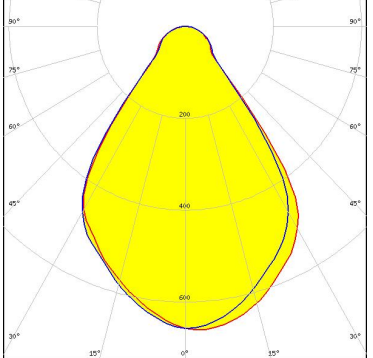
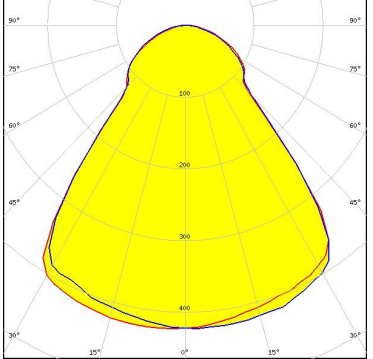
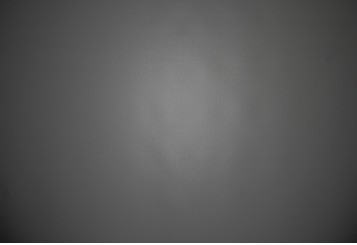
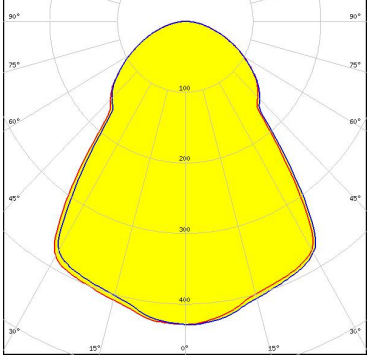
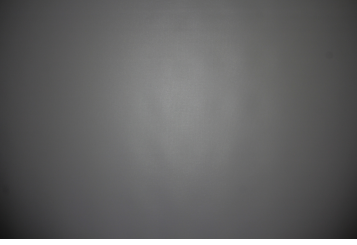
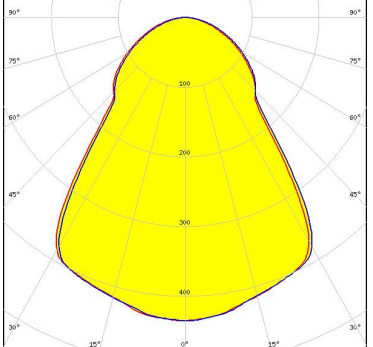
<p>OSRAM Opto Semiconductors</p> <p>LED OSLON SSL 80</p> <p>FWHM / FWTM 76.0° / 132.0°</p> <p>Efficiency 92 %</p> <p>Peak intensity 0.5 cd/lm</p> <p>LEDs/each optic 1</p> <p>Light colour White</p> <p>Required components:</p>		
<p>SEOUL SEOUL SEMICONDUCTOR</p> <p>LED Z5</p> <p>FWHM / FWTM 80.0° / 150.0°</p> <p>Efficiency 84 %</p> <p>Peak intensity 0.4 cd/lm</p> <p>LEDs/each optic 1</p> <p>Light colour White</p> <p>Required components:</p>		
<p>SEOUL SEOUL SEMICONDUCTOR</p> <p>LED Z8Y15</p> <p>FWHM / FWTM 76.0° / 148.0°</p> <p>Efficiency 87 %</p> <p>Peak intensity 0.4 cd/lm</p> <p>LEDs/each optic 1</p> <p>Light colour White</p> <p>Required components:</p>		
<p>SEOUL SEOUL SEMICONDUCTOR</p> <p>LED Z8Y19</p> <p>FWHM / FWTM 76.0° / 147.0°</p> <p>Efficiency 86 %</p> <p>Peak intensity 0.4 cd/lm</p> <p>LEDs/each optic 1</p> <p>Light colour White</p> <p>Required components:</p>		

PHOTOMETRIC DATA (SIMULATED):

CREE LED

LED XD16
 FWHM / FWTM 82.0° / 151.0°
 Efficiency 83 %
 Peak intensity 0.4 cd/lm
 LEDs/each optic 1
 Light colour White
 Required components:

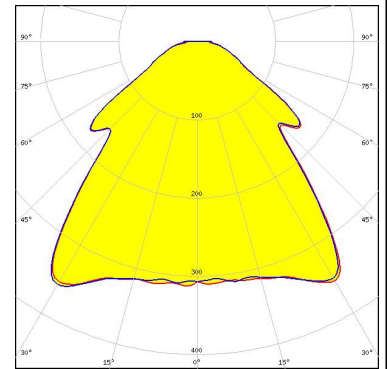

CREE LED

LED XHP35 HD
 FWHM / FWTM 91.0° / 154.0°
 Efficiency 92 %
 Peak intensity 0.4 cd/lm
 LEDs/each optic 1
 Light colour White
 Required components:

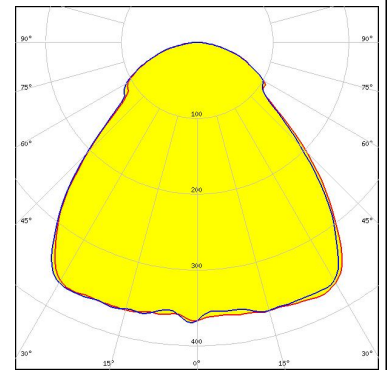

CREE LED

LED XHP35.2
 FWHM / FWTM 91.0° / 159.0°
 Efficiency 79 %
 Peak intensity 0.3 cd/lm
 LEDs/each optic 1
 Light colour White
 Required components:

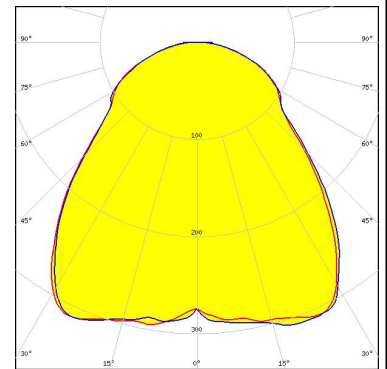

CREE LED

LED XP-E2
 FWHM / FWTM 79.0° / 142.0°
 Efficiency 79 %
 Peak intensity 0.4 cd/lm
 LEDs/each optic 1
 Light colour White
 Required components:

Protective plate, glass

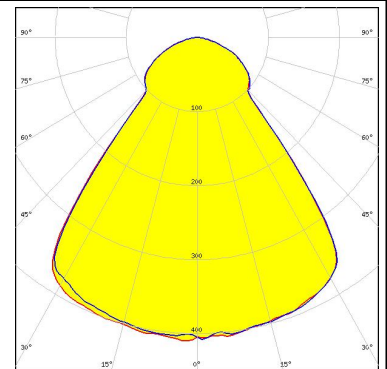

PHOTOMETRIC DATA (SIMULATED):

CREE LED

LED XP-G2 HE
 FWHM / FWTM 85.0° / 154.0°
 Efficiency 82 %
 Peak intensity 0.4 cd/lm
 LEDs/each optic 1
 Light colour White
 Required components:

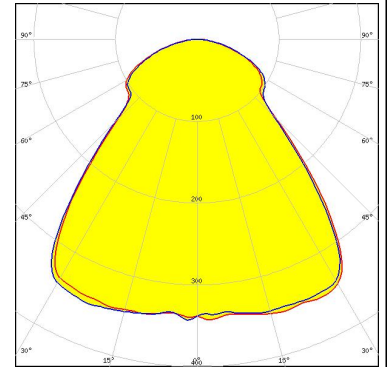

CREE LED

LED XP-L HD
 FWHM / FWTM 81.0° / 145.0°
 Efficiency 83 %
 Peak intensity 0.4 cd/lm
 LEDs/each optic 1
 Light colour White
 Required components:

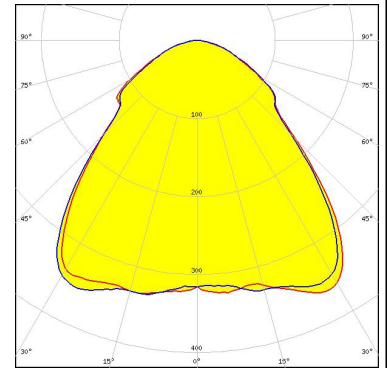

CREE LED

LED XQ-E HD
 FWHM / FWTM 76.0° / 145.0°
 Efficiency 90 %
 Peak intensity 0.5 cd/lm
 LEDs/each optic 1
 Light colour White
 Required components:



LUMILEDS

LED LUXEON 2835 Line
 FWHM / FWTM 80.0° / 144.0°
 Efficiency 85 %
 Peak intensity 0.4 cd/lm
 LEDs/each optic 1
 Light colour White
 Required components:

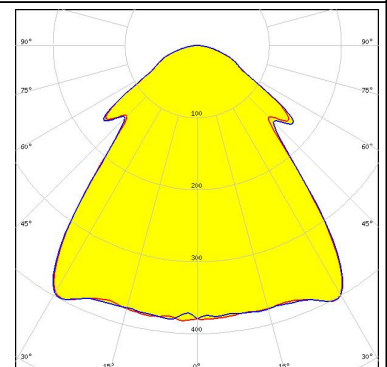

PHOTOMETRIC DATA (SIMULATED):

<p>LUMILEDS</p> <p>LED LUXEON H50-2 FWHM / FWTM 80.0° / 146.0° Efficiency 90 % Peak intensity 0.4 cd/lm LEDs/each optic 1 Light colour White Required components:</p>	
<p>NICHIA</p> <p>LED NVSxx19B/NVSxx19C FWHM / FWTM 82.0° / 150.0° Efficiency 80 % Peak intensity 0.4 cd/lm LEDs/each optic 1 Light colour White Required components:</p>	
<p>OSRAM Opto Semiconductors</p> <p>LED Duris S5 (2 chip) FWHM / FWTM 76.0° / 146.0° Efficiency 82 % Peak intensity 0.4 cd/lm LEDs/each optic 1 Light colour White Required components:</p>	
<p>OSRAM Opto Semiconductors</p> <p>LED OSLOM Square CSSRM2/CSSRM3 FWHM / FWTM 80.0° / 146.0° Efficiency 83 % Peak intensity 0.4 cd/lm LEDs/each optic 1 Light colour White Required components:</p>	

PHOTOMETRIC DATA (SIMULATED):

OSRAM
Opto Semiconductors

LED	SFH 4727AS
FWHM / FWTM	55.0° / 83.0°
Efficiency	89 %
Peak intensity	1 cd/lm
LEDs/each optic	1
Light colour	IR
Required components:	

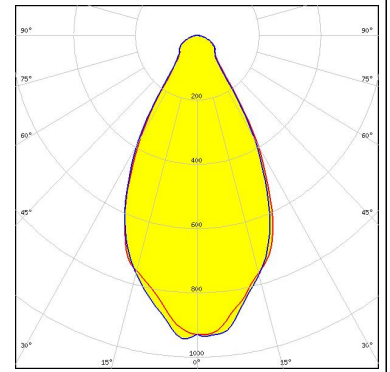

GENERAL INFORMATION:

NOTE: The typical beam angle will be changed by different color, chip size and chip position tolerance. The typical total beam angle is the full angle measured where the luminous intensity is half of the peak value.

MATERIALS:

As part of our continuous research and improvement processes, and to ensure the best possible quality and availability of our products, LEDiL reserves the right to change material grades without notice.

PRODUCT DATA USER AGREEMENT AND DISCLAIMER:

The measured data in the provided downloadable LEDiL Product Datasheets and Mechanical 2D-Drawings is rounded and provided as reference for planning. LEDiL Oy's optical specifications have been verified by conducting performance testing of the products in accordance with the company's quality system. The reported data are averaged results of multiple measurements with typical variation. LEDiL Oy reserves the right to without prior notification make changes and improvements to its products.

LEDiL Oy assumes neither warranty, nor guarantee nor any other liability of any kind for the contents and correctness of the provided data. The provided data has been generated with highest diligence but the provided data may in reality not represent the complete possible variation range of all intrinsic parameters. Therefore, in certain cases a deviation from the provided data could occur.

LEDiL Oy reserves the right to undertake technical changes of its products without further notification which could lead to changes in the provided data. LEDiL Oy assumes no liability of any kind for the possible deviation from any provided data or any other damage resulting from the usage of the provided data.

The user agrees to this disclaimer and user agreement with the download or usage of the provided files.

LEDiL Oy

Joensuunkatu 13
FI-24240 SALO
Finland

LEDiL Inc.

228 West Page Street
Suite D
Sycamore IL 60178
USA

Ledil Optics Technology (Shenzhen) Co., Ltd.

405 , Block B
Casic Motor Building
Shenzhen 518057
P.R.CHINA

Local sales and technical support

[www.ledil.com/
where_to_buy](http://www.ledil.com/where_to_buy)

Shipping locations

Salo, Finland
Hong Kong, China

Distribution Partners

[www.ledil.com/
where_to_buy](http://www.ledil.com/where_to_buy)