



TAOGLAS®



Datasheet

Bolt

Part No:
A.80.A.101111

Description:

Bolt - Low Profile High Precision GNSS L1 & L2 Antenna with 1m RG-174 & SMA(M)

Features:

Designed for GPS L1 & L2 Band Operation

Supported GNSS Bands:

GPS L1 & L2; GLONASS G1 & G2; BeiDou B1 & B2; Galileo E1 & E5b

Low Profile, Vandal Resistant Design

Permanent Mount IP67 Rated Enclosure

UV Resistant Housing

Wide Input Voltage [1.8V – 5V]

Cable: 1m RG-174

Connector: SMA(M)ST

Dimensions: Ø94.3 x H25.4mm

RoHS & Reach Compliant

1. Introduction	3
2. Specifications	4
3. Antenna Characteristics	7
4. Radiation Patterns	13
5. Active Characteristics	18
6. Mechanical Drawing	21
7. Mechanical Drawing	22
8. Packaging	23
<hr/>	
Changelog	25

Taoglas makes no warranties based on the accuracy or completeness of the contents of this document and reserves the right to make changes to specifications and product descriptions at any time without notice. Taoglas reserves all rights to this document and the information contained herein. Reproduction, use or disclosure to third parties without express permission is strictly prohibited.



1. Introduction



The Bolt, A.80 is a high gain GNSS L1 & L2(GPS/GLONASS/Galileo/BeiDou) antenna that features very high out of band rejection and can handle large bursts of power from nearby transmitters. These characteristics make the A.80 ideal for applications where the antenna will be placed near high-power transmitters, such as cellular base stations or radar systems.

The A.80 utilizes a very high efficiency (>70%) patch antenna that has been tuned for best possible performance within the enclosure to maximize signal quality. The internal LNAs have very low noise figure to maintain excellent signal quality throughout the entire signal chain. The signal chain also features carefully selected and placed SAW filters that collectively allow for very sharp signal attenuation outside of the intended frequency bands without negatively impacting in-band signal quality.

The A.80 features excellent rejection across all non-GNSS frequencies to prevent overdriving or damaging your GPS receiver. At the 850/900MHz cellular bands, for example, the A.80 exhibits greater than 50dB of rejection. At the 1800/1900MHz cellular bands, it exhibits >65dB, making it best in class when out of band interference is a concern. Even with this excellent out of band attenuation, the A.80 maintains a low noise figure of 4dB and high gain of >21dB, making it an ideal solution for applications with longer cable runs where high cable loss is a concern.

Cable lengths and connector types are customizable. Contact your regional Taoglas customer support team for further information.

2. Specifications

GNSS Frequency Bands Covered						
GPS	L1	L2	L5			
	■	■	□			
GLONASS	G1	G2	G3			
	■	■	□			
Galileo	E1	E5a	E5b	E6		
	■	□	■	□		
BeiDou	B1	B2a	B2b	B3		
	■	□	■	■		
QZSS (Regional)	L1	L2C	L5	L6		
	■	■	□	□		
IRNSS (Regional)	L5					
	□					
SBAS	L1/E1/B1	L5/B2a/E5a	G1	G2	G3	
	■	□	■	■	□	

■ GNSS Frequency Bands Covered. □ GNSS Frequency Bands Not Covered.

*SBAS systems: WASS(L1/L5), EGNOS(E1/E5a), SDCM(G1/G2/G3), SNAS(B1,B2a), GAGAN(L1/L5), QZSS(L1/L5), KAZZ(L1/L5).

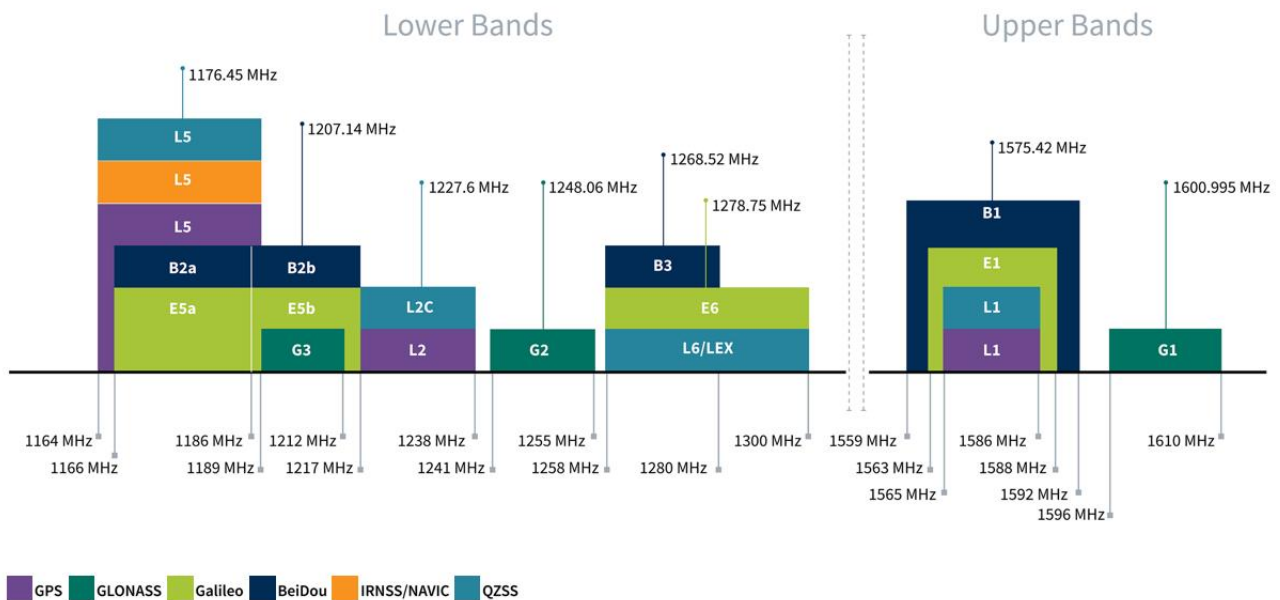

GNSS Bands and Constellations

Electrical Specification							
Band		GPS L1			GPS L2		
Centre Frequency		1575.42±3MHz			1227.60MHz		
Efficiency (%)	Free Space	70.59			39.42		
	On 30x30cm GP	49.62			53.02		
Average Gain(dB)	Free Space	-1.51			-4.04		
	On 30x30cm GP	-3.04			-2.76		
Peak gain(dBi)	Free Space	3.99			1.21		
	On 30x30cm GP	1.89			3.07		
Group Delay	On 30x30cm GP	3			10		
PCO (cm)	On 30x30cm GP	2.1			1.5		
PCV (cm)	On 30x30cm GP	5.6			0.75		
Bandwidth		10MHz					
Return loss		<- 10					
VSWR		< 2					
Axial ratio		3dB Typ.					
Gain @ Zenith		3.5dBi Typ.			1dBi Typ.		
Impedance		50Ω					
Polarization		RHCP					
LNA Specification							
Frequency		GPS L1 1575.42MHz			GPS L2 1227.60MHz		
DC Power Input		1.8V	3.0V	5V	1.8V	3.0V	5V
Gain (dB)		22.01	23.25	24.75	24.79	26.31	27.88
Noise Figure (dB)		4.01	4.20	4.39	2.6	2.8	2.97
Impedance		50Ω					
Power Consumption		Typ:20mA Max:40mA					

Mechanical	
Dimension	94.3mm*25.4mm
Cable	1m RG-174
Connector	SMA(M)
Housing Material	ASA
IP Rating	IP67
Weight	250g
Humidity	Non-condensing 65°C 95% RH
Operating temp	-20°C ~ +65°C
Storage Temp	-30°C ~ +75°C
Environmental	
IP Rating	IP67
Temperature Range	-40°C to 85°C
Humidity	Non-condensing 65°C 95% RH
Cable Pull	Pull horizontal max pull force(kgf): 0.52 Pull vertical max pull force(kgf): 0.48

3. Antenna Characteristics

3.1 Return Loss in Free Space

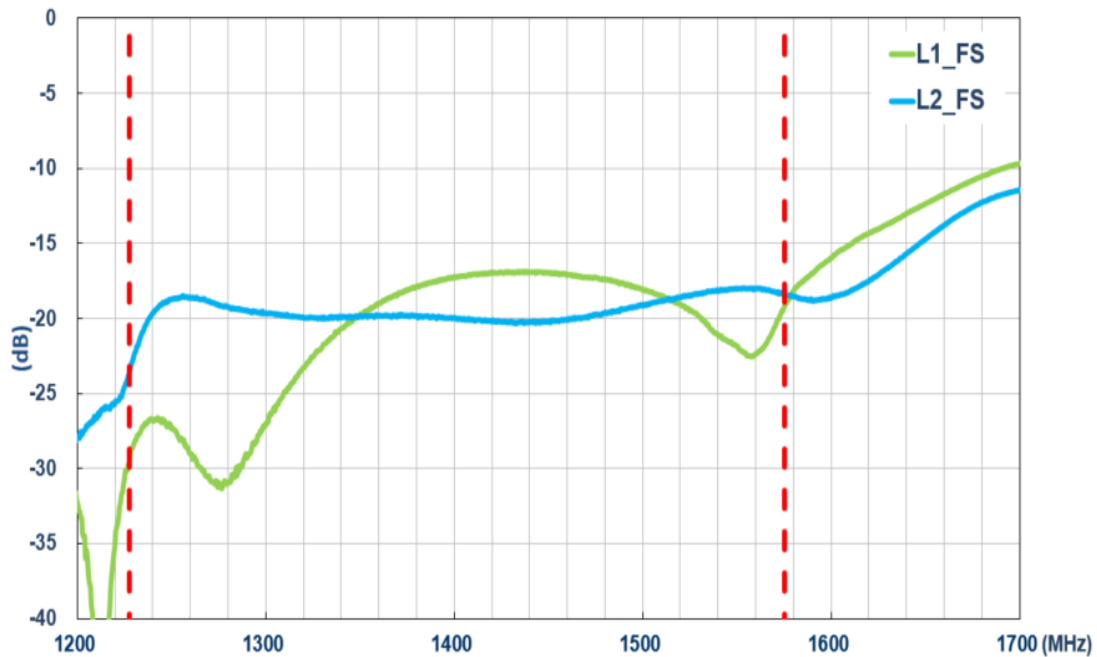

3.2 Return Loss on 30*30cm Ground Plane

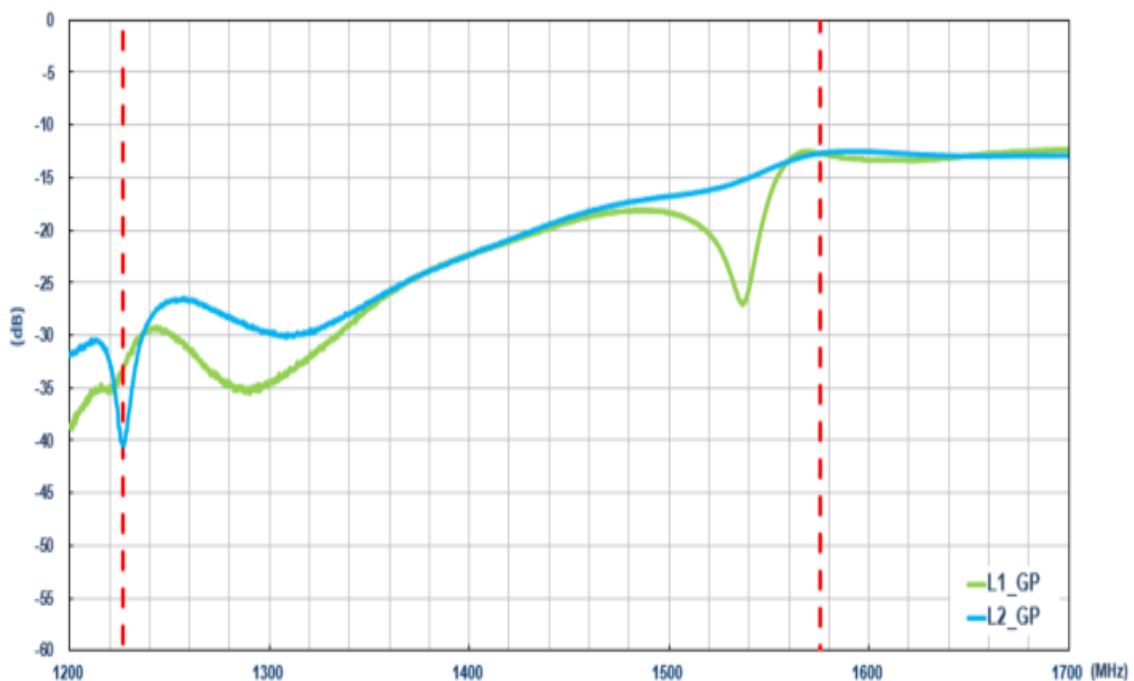

3.3 Efficiency in Free Space

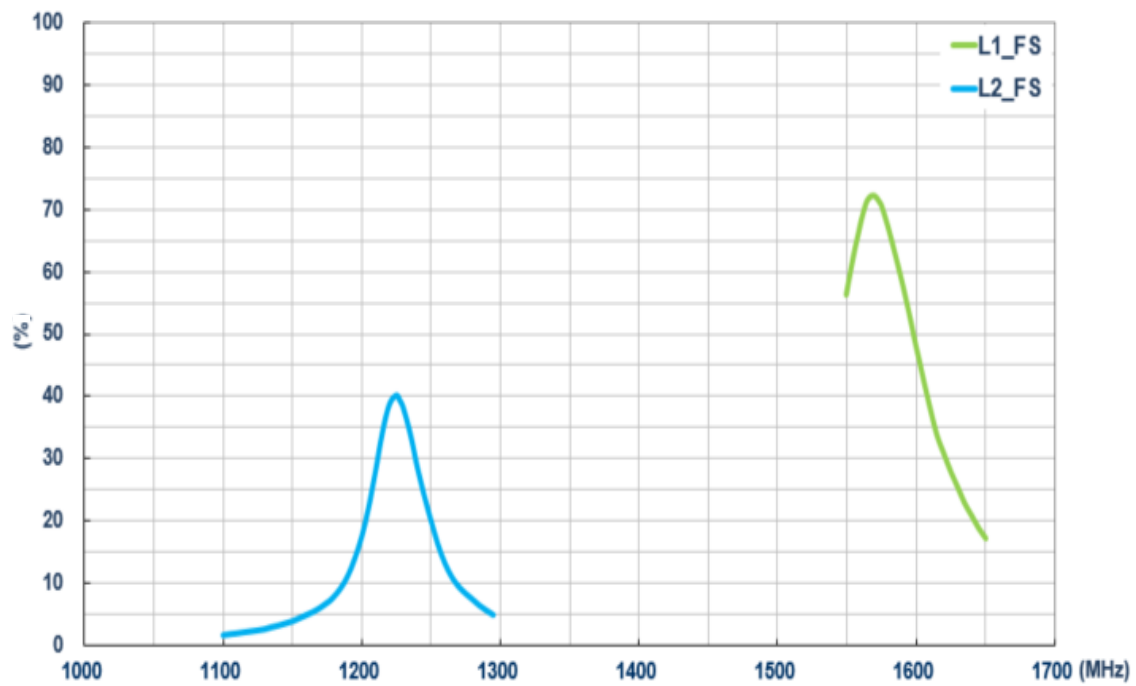

3.4 Efficiency on 30*30cm Ground Plane

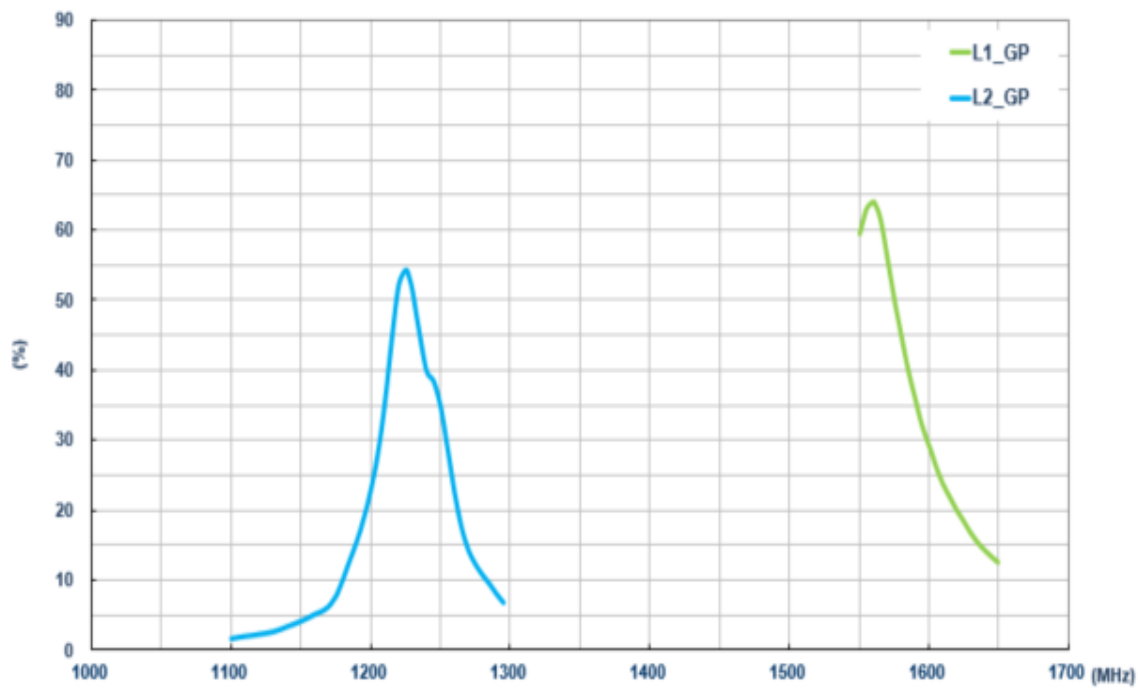

3.5 Average Gain in Freespace

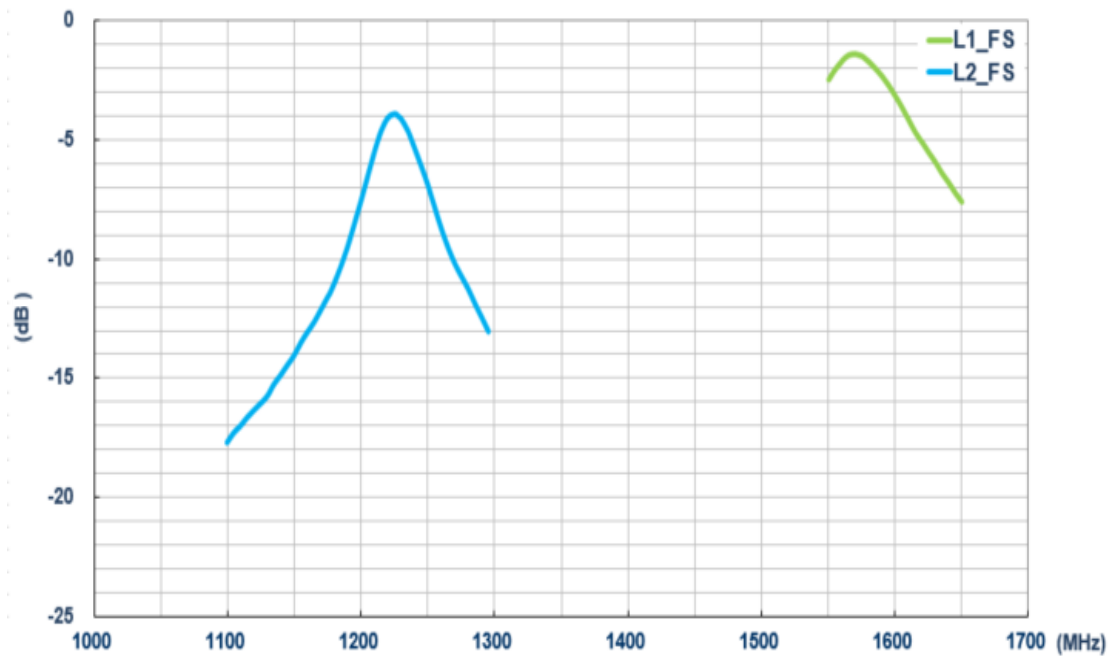

3.6 Average Gain on 30*30cm Ground Plane

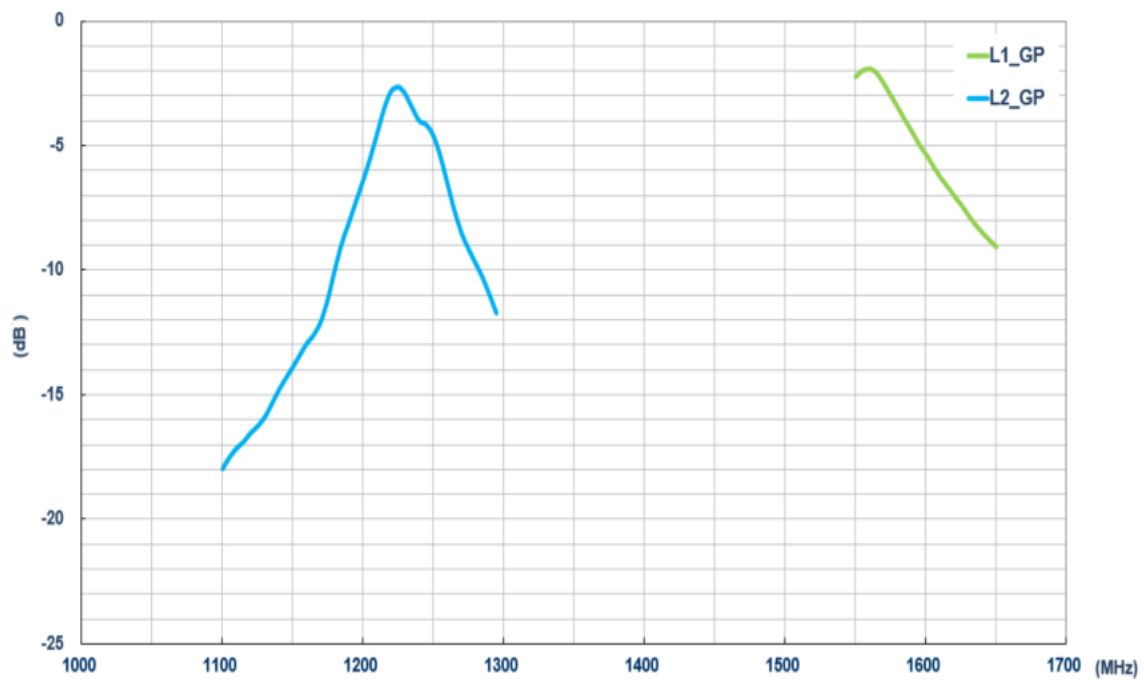

3.7 Peak Gain in Free Space

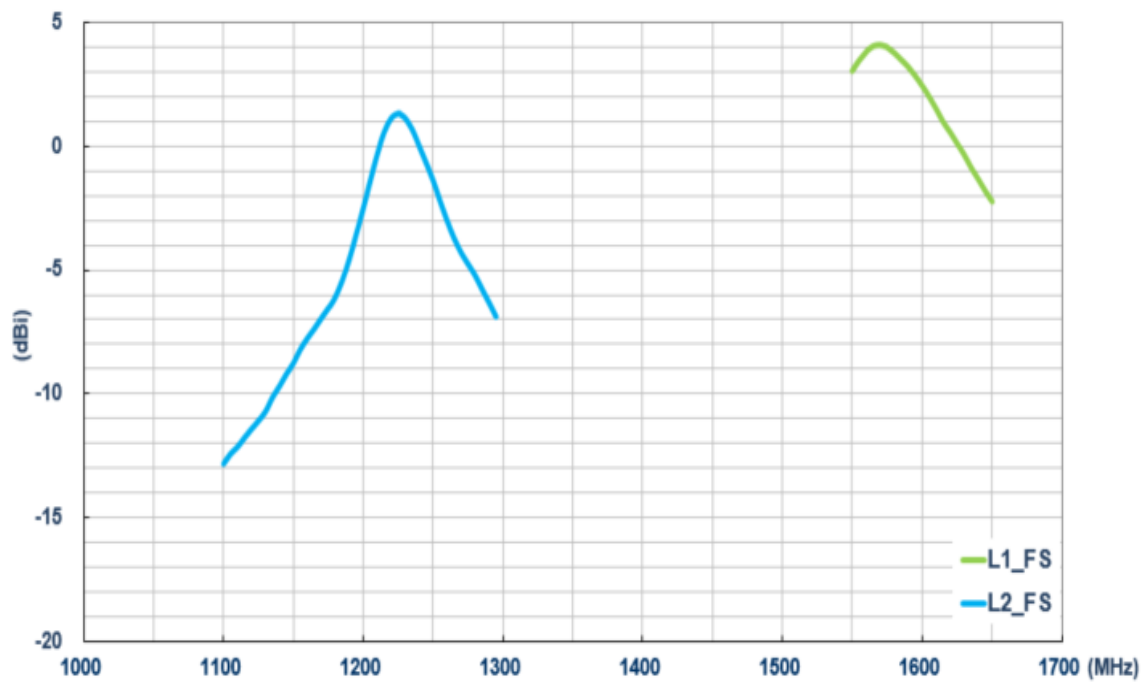

3.8 Peak Gain on 30*30cm Ground Plane

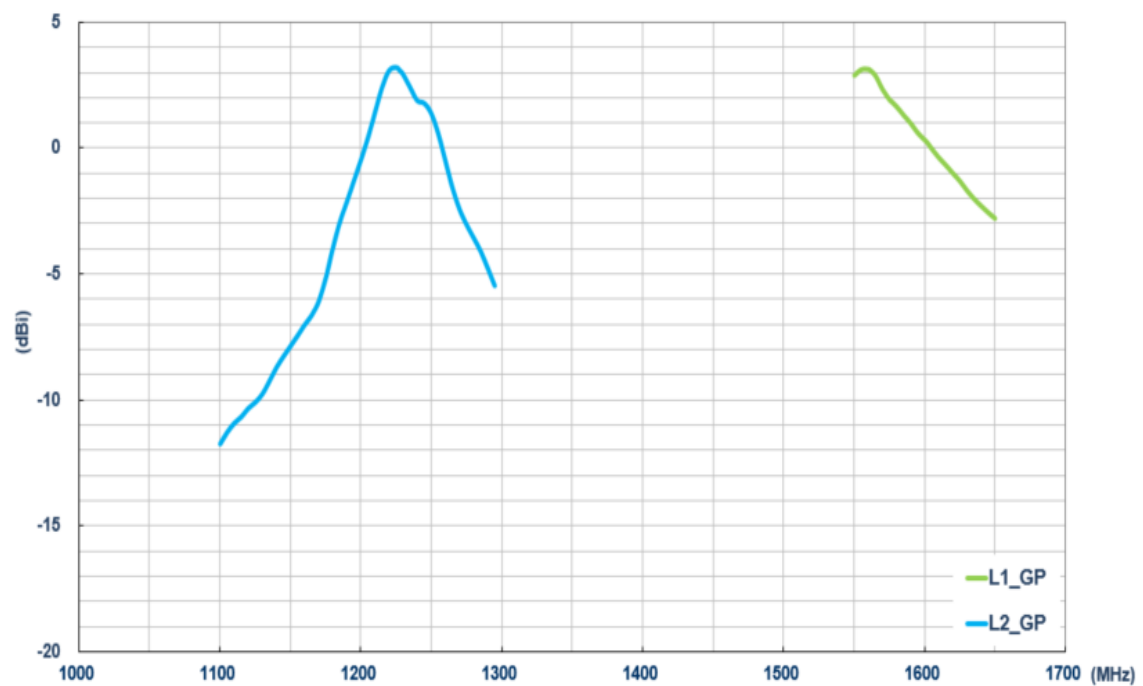

3.9 Axial Ratio @ 1575MHz - in Free Space

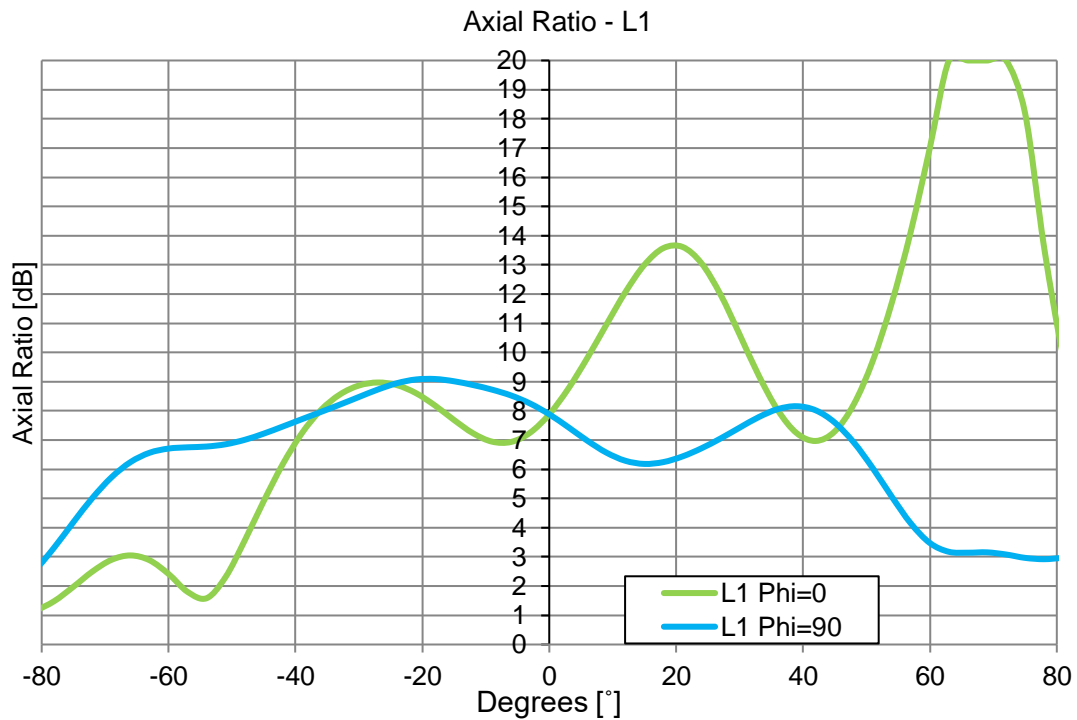

3.10 Axial Ratio @ 1575MHz - on 30*30cm Ground Plane

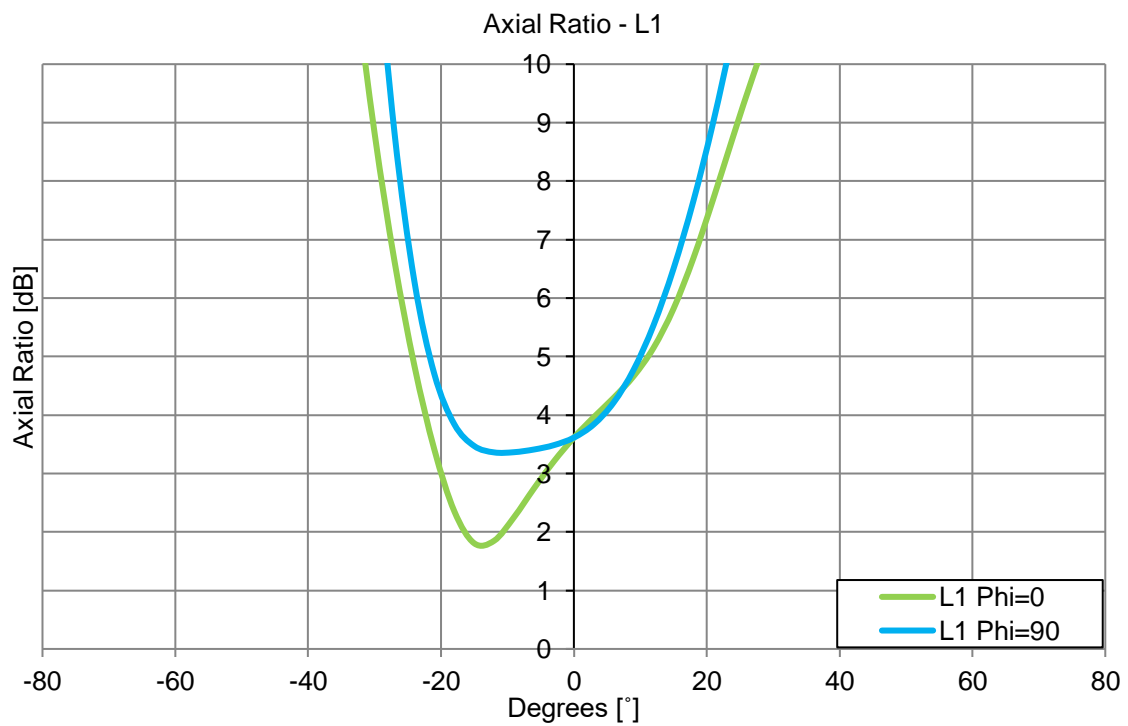

3.11 Axial Ratio @ 1227.6MHz - in Free Space

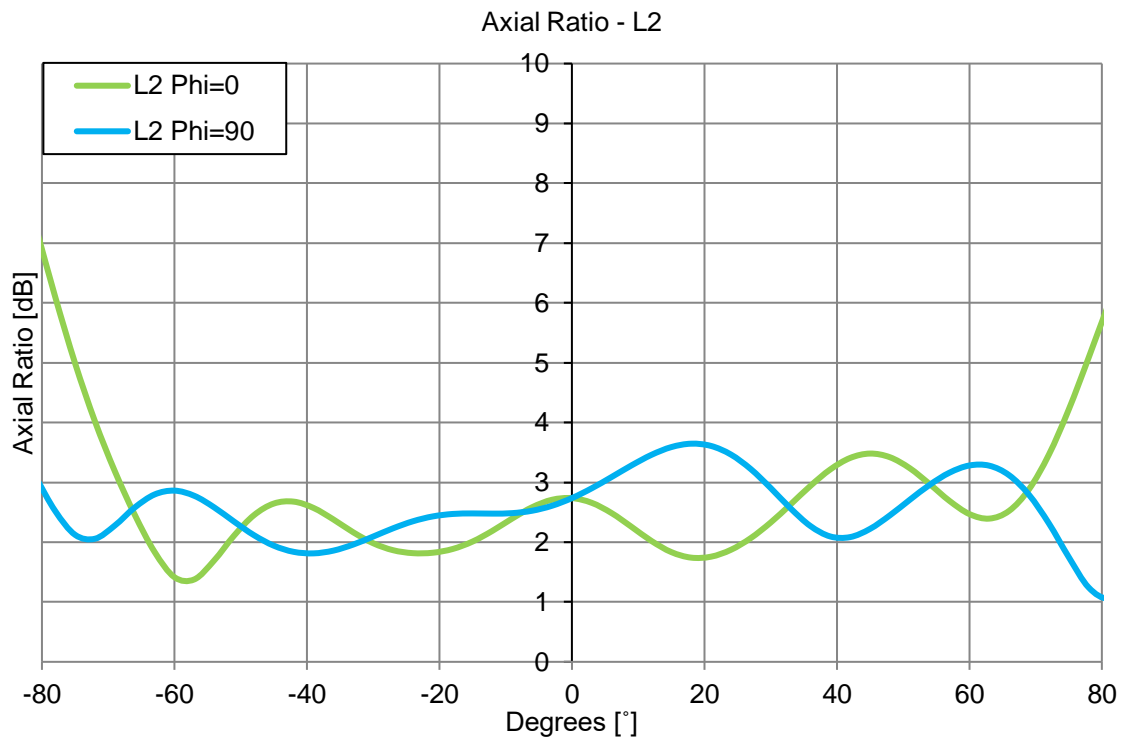

3.12 Axial Ratio @ 1227.6MHz - On 30*30cm Ground Plane

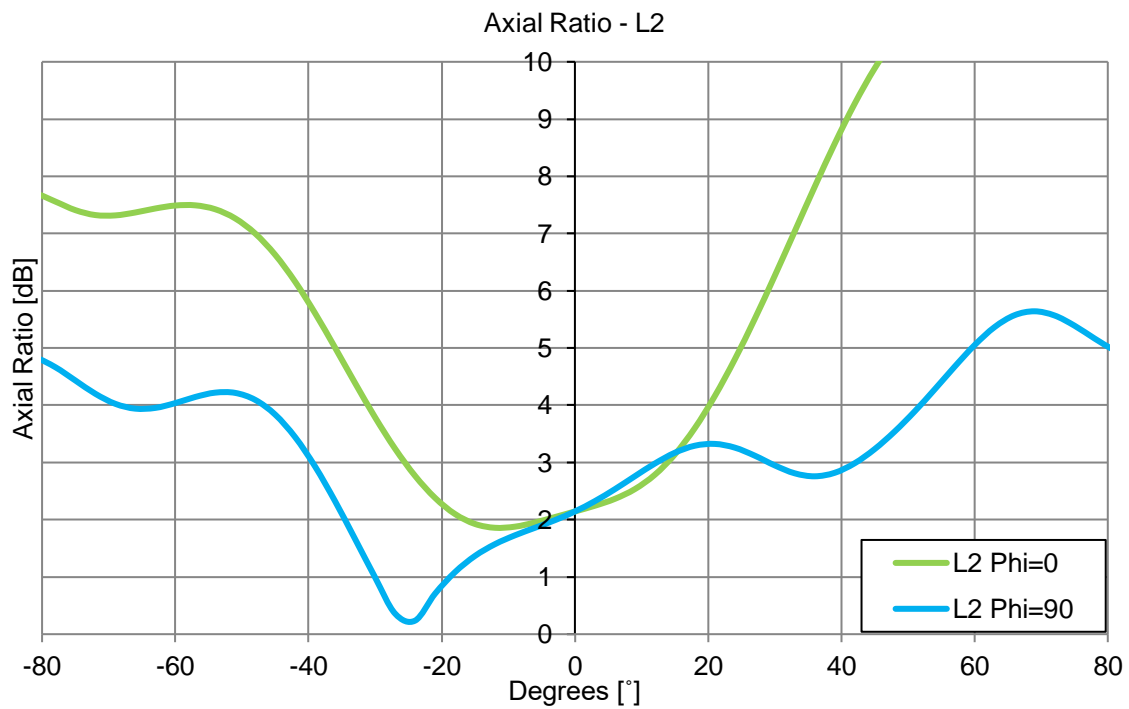

4. Radiation Patterns

4.1 Test Setup

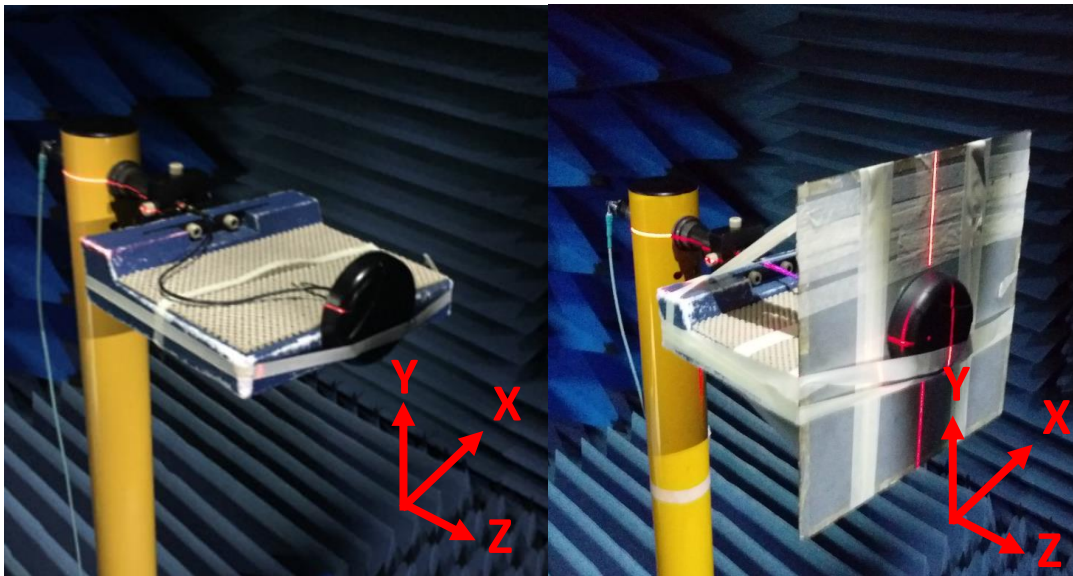

Free Space

On 30*30cm Ground Plane

4.2 1575.42MHz 3D and 2D Radiation Patterns (Freespace)

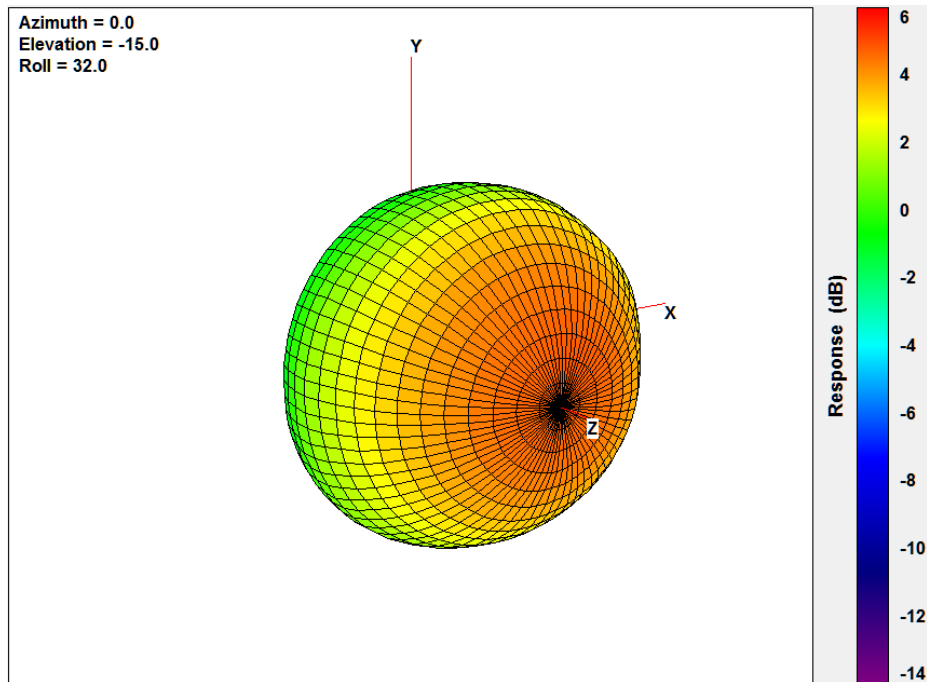

XY Plane

XZ Plane

YZ Plane

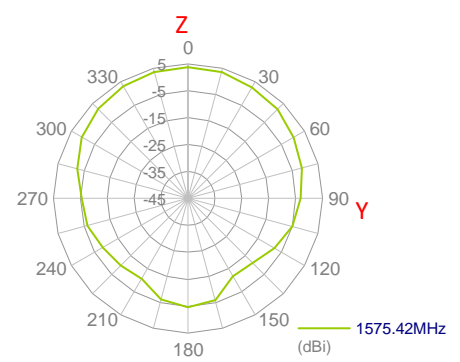
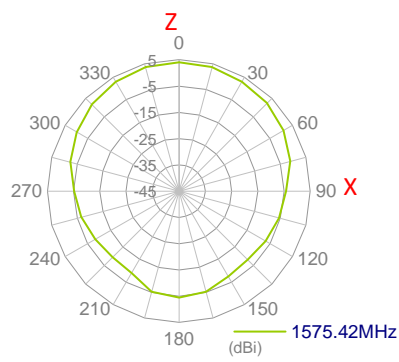
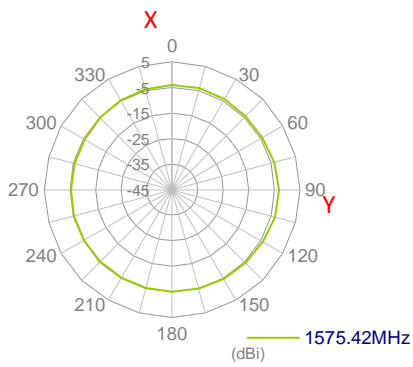

4.3 1227.6MHz 3D and 2D Radiation Patterns (Freespace)

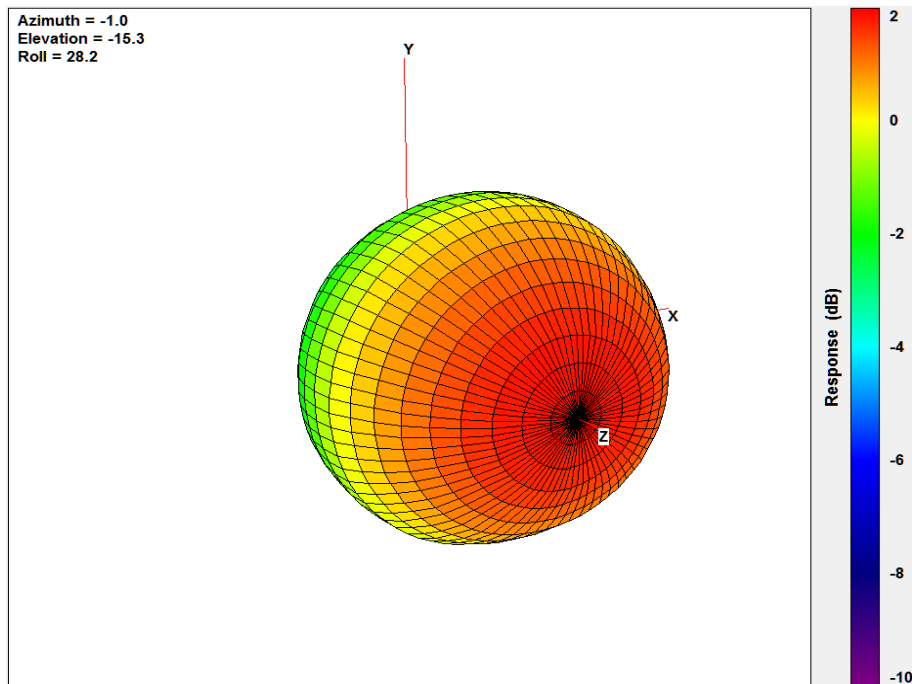

XY Plane

XZ Plane

YZ Plane

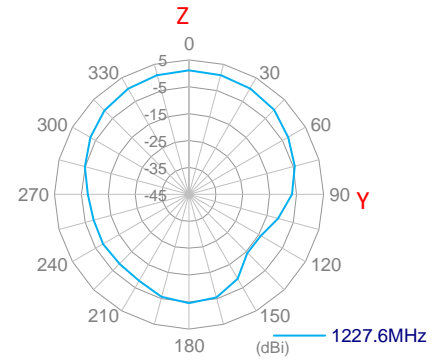
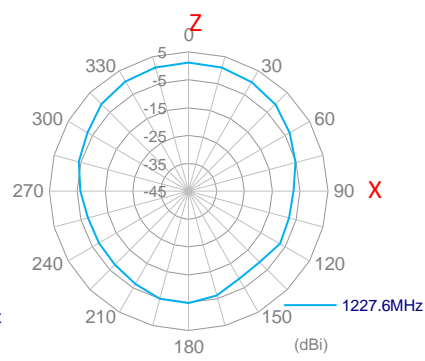
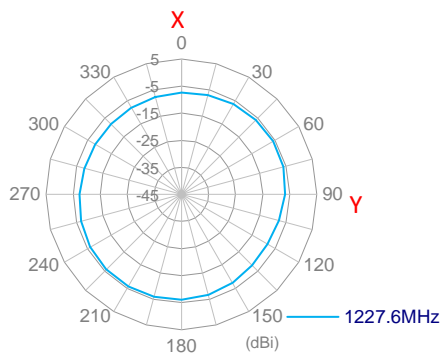

4.4 1575.42MHz 3D and 2D Radiation Patterns on 30*30cm ground plane

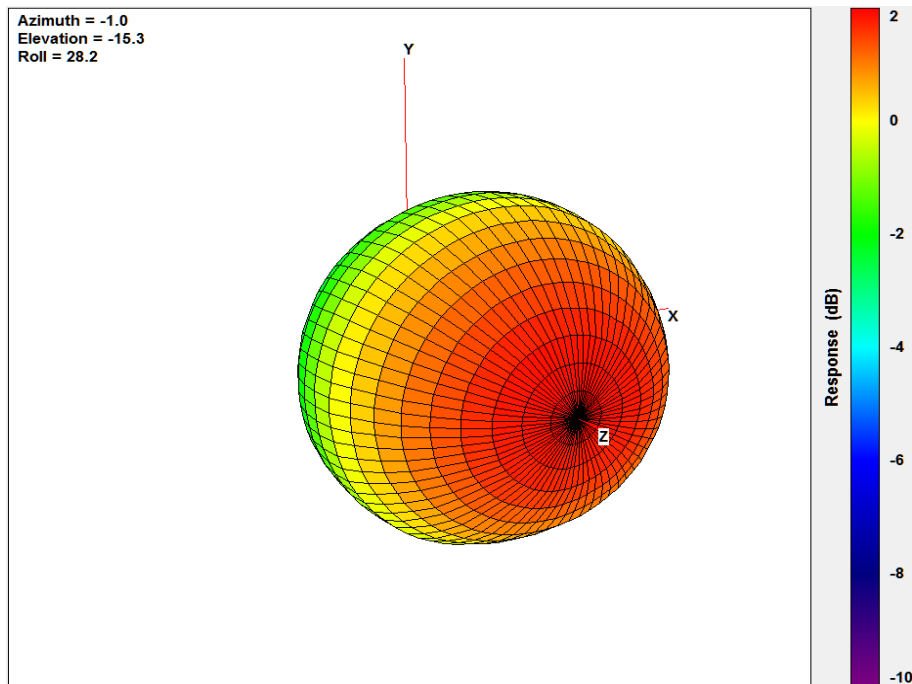

XY Plane

XZ Plane

YZ Plane

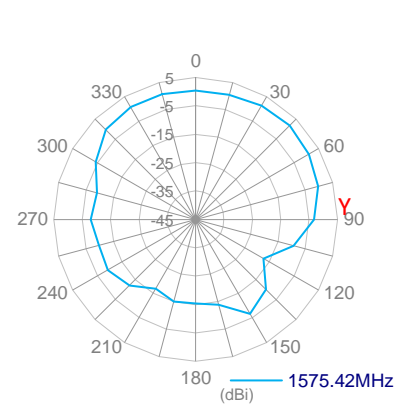
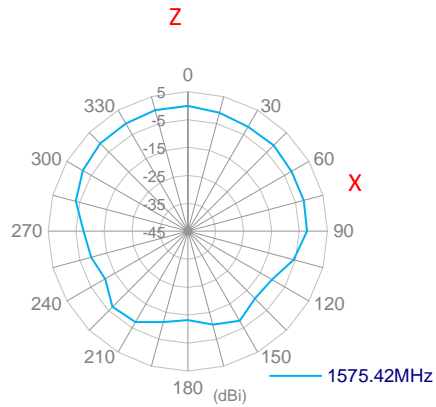
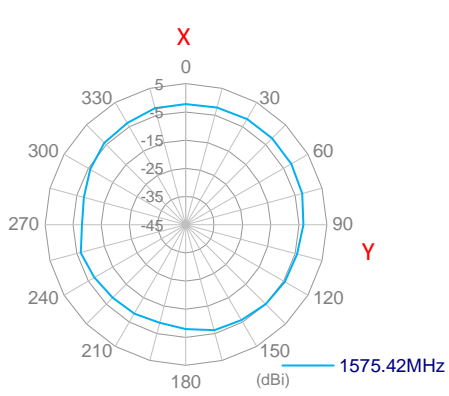

4.5 1227.6MHz 3D and 2D Radiation Patterns on 30*30cm ground plane

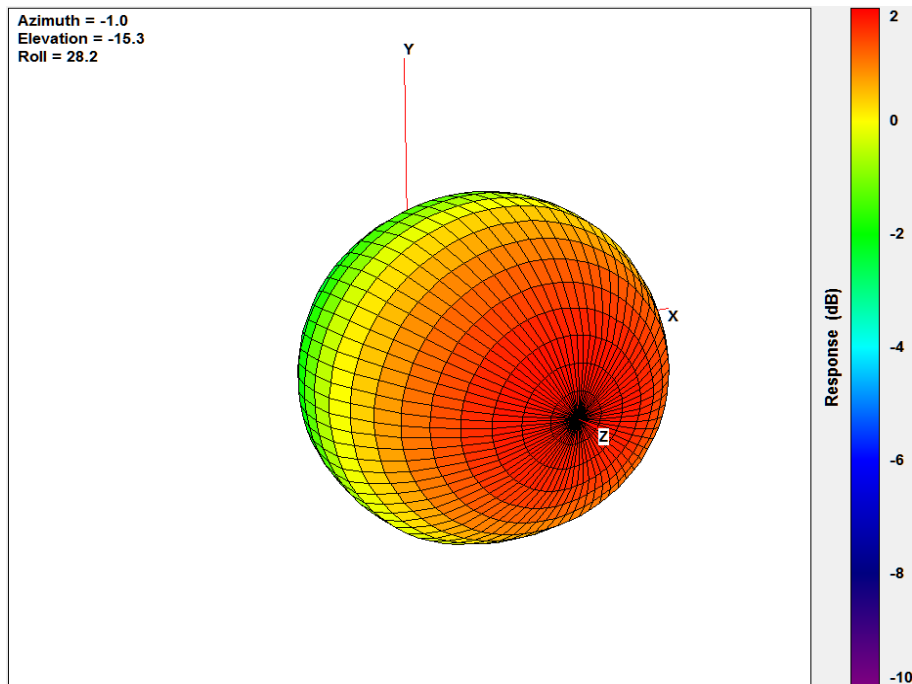

XY Plane XZ Plane YZ Plane

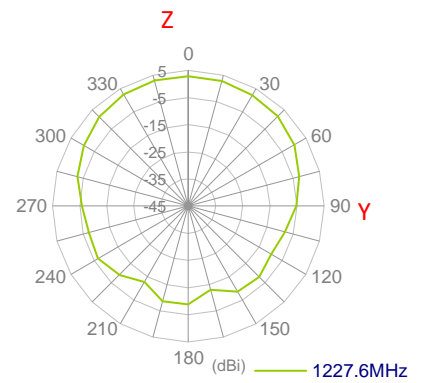
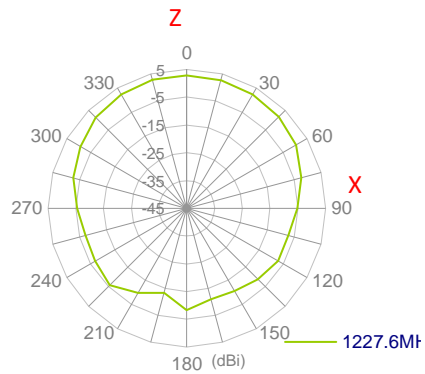
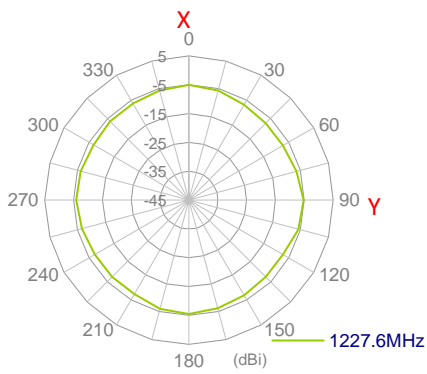

5. Active Characteristics

5.1 LNA Gain – L1 @ 3V

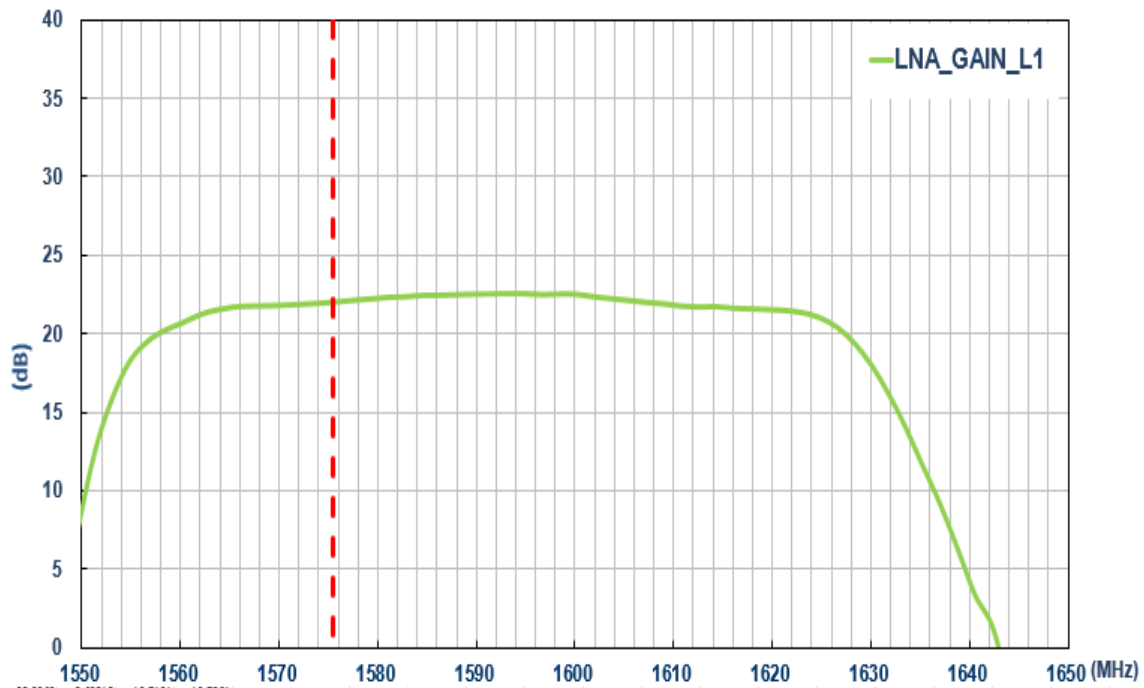

5.2 LNA Gain – L2@3V

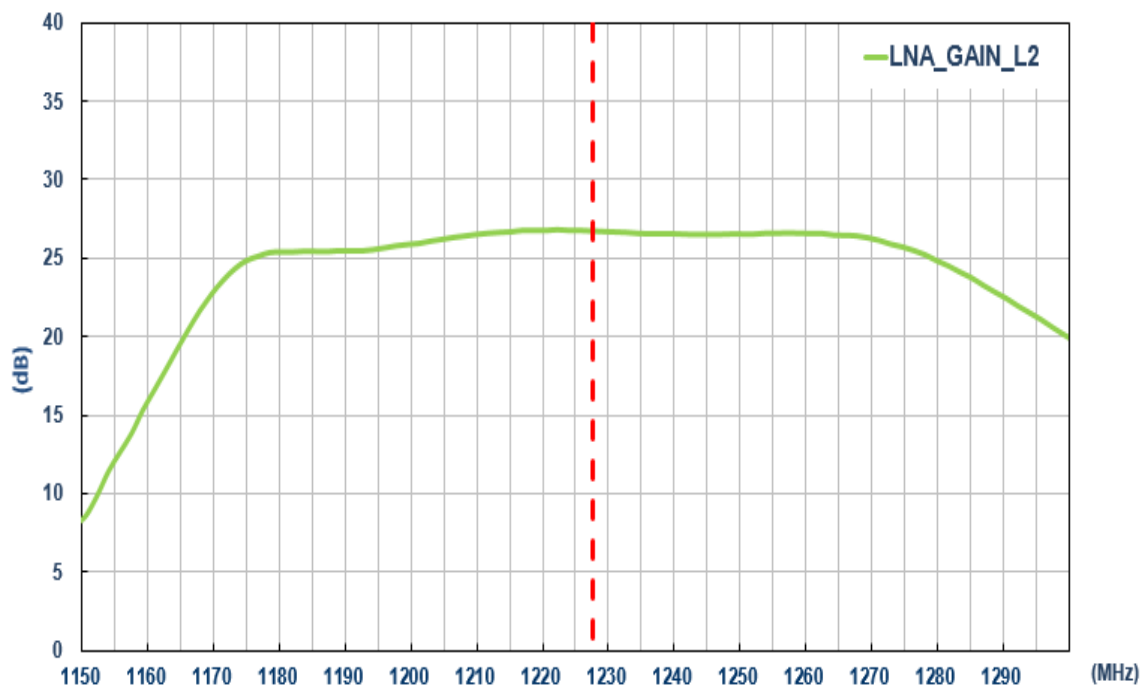

5.3 Noise Figure – L1 @ 3V

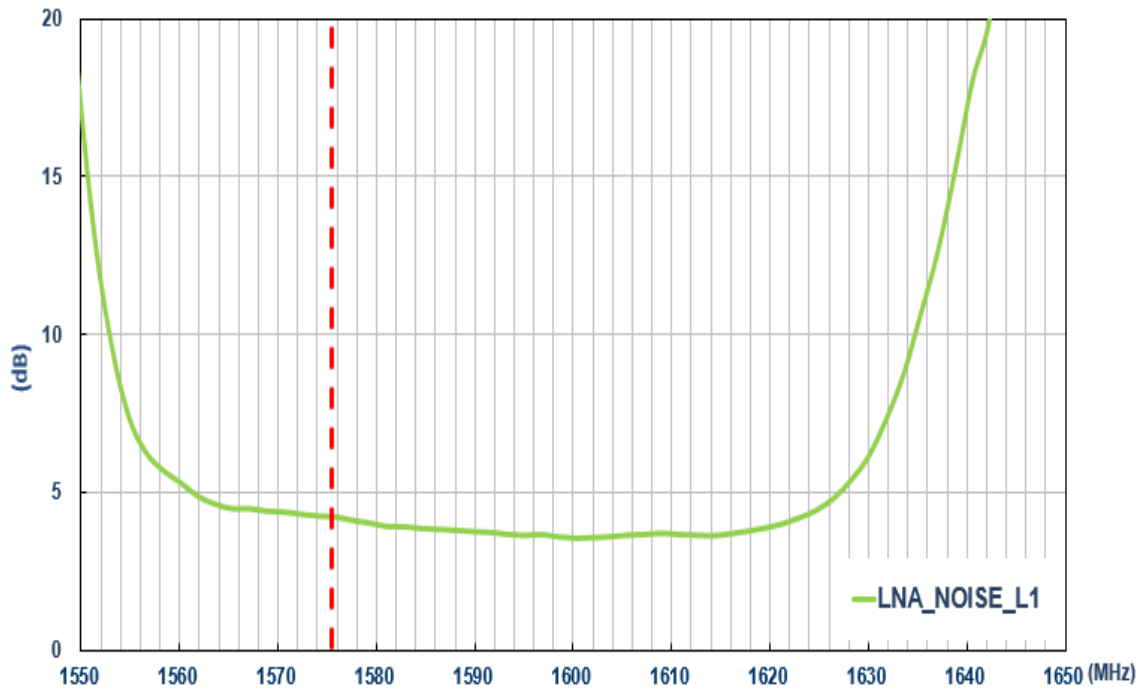

5.4 Noise Figure – L2@3V

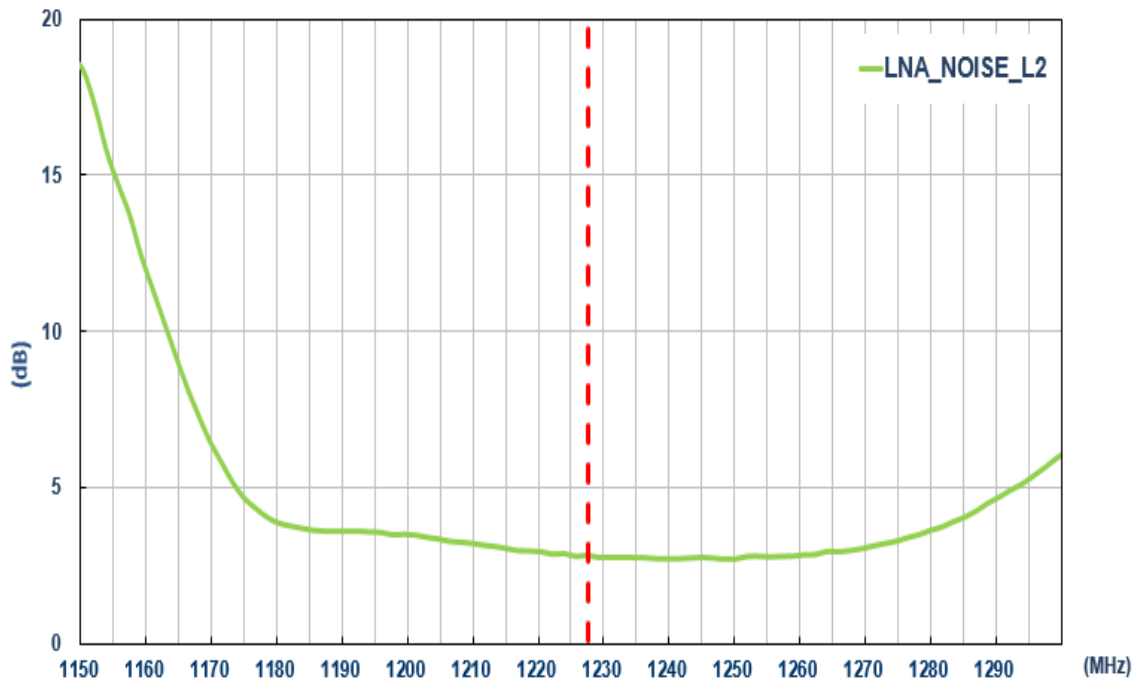

5.5 Out of Band Rejection – L1 @ 3V

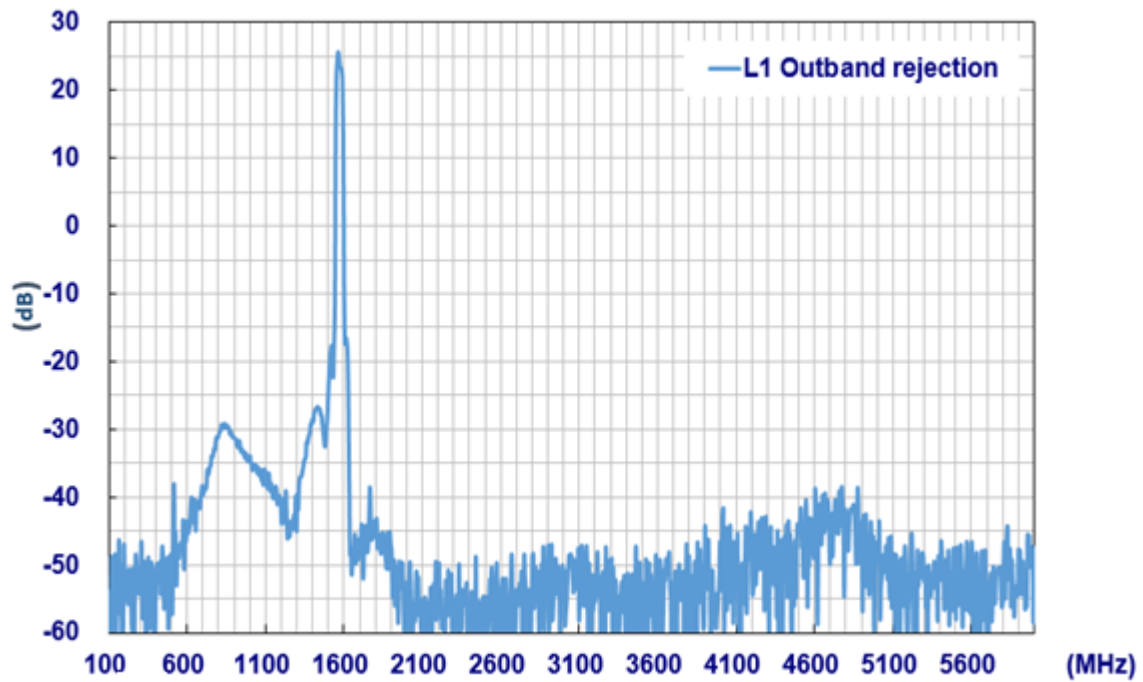

5.6 Out of Band Rejection – L2@3V

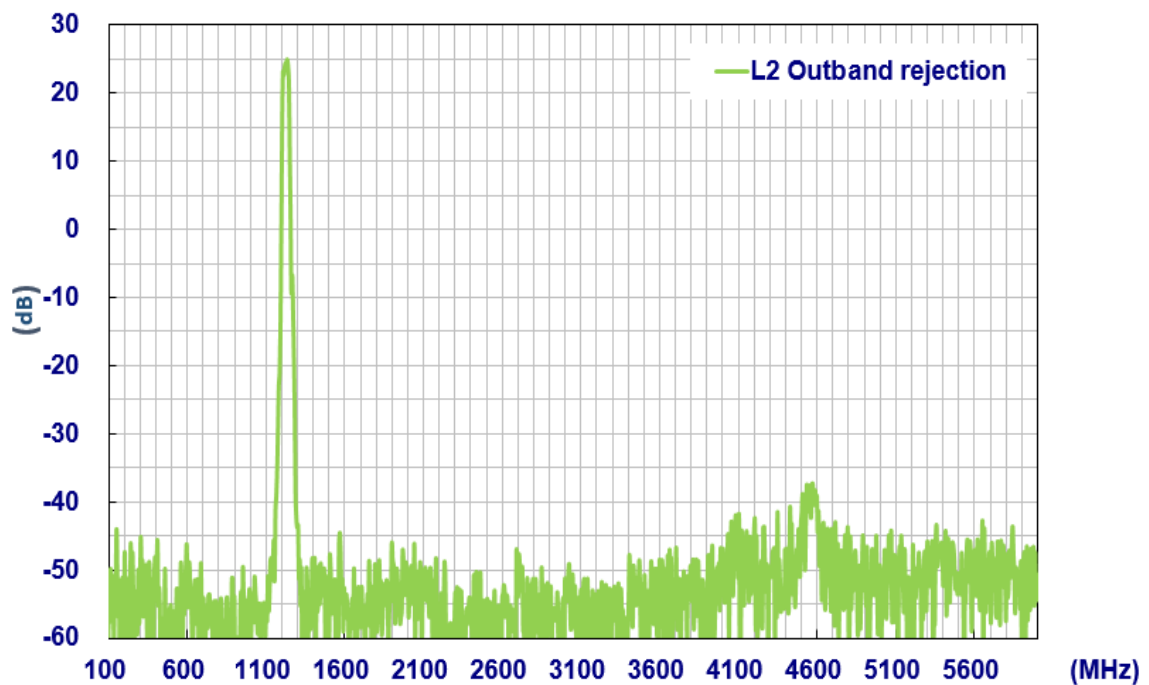

6. Field Test Results

6.1 Rooftop test

In this section Taoglas will present the field test result for AA.200 antenna. The test was performed when the antenna was mounted on a static rooftop test set up in an open sky environment for at least **6 hours**.

Taoglas will show the field test results using the following receiver:

1. U-blox ZED-F9P

Receiver features:

- Multi-band GNSS: 184-channel GPS L1C/A L2C, GLONASS: L1OF L2OF, Galileo: E1B/C E5b, BeiDou: B1I B2I, QZSS: L1C/A L2C
- Multi-band RTK with fast convergence times and reliable performance
- Nav. update rate RTK up to 20 Hz
- Position accuracy = RTK 0.01 m + 1 ppm CEP

Positioning Accuracy Table (2D Accuracy)					
Test Condition	Correction Service	CEP (50%)	DRMS (68%)	2DRMS (95-98.2%)	TTF (sec)
Free Space	RTK DISABLED	73.91 cm	89.45 cm	178.91 cm	30
	RTK ENABLED	1.74 cm	2.12 cm	4.23 cm	30
30x30 cm Ground Plane	RTK DISABLED	33.82 cm	42.82 cm	85.64 cm	25
	RTK ENABLED	0.99 cm	1.19 cm	2.37 cm	25

RTK Availability
Free Space

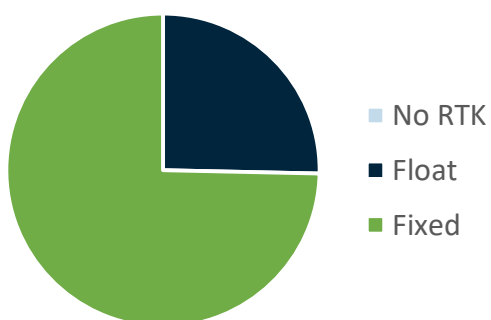

RTK Availability
30x30 cm ground plane

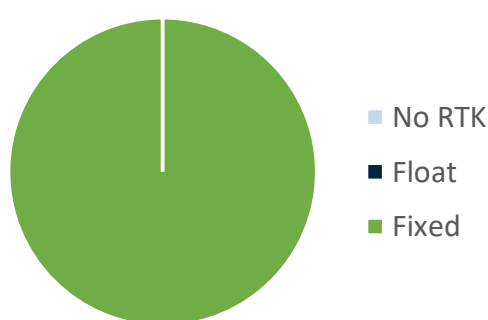

7. Mechanical Drawing (Units: mm)

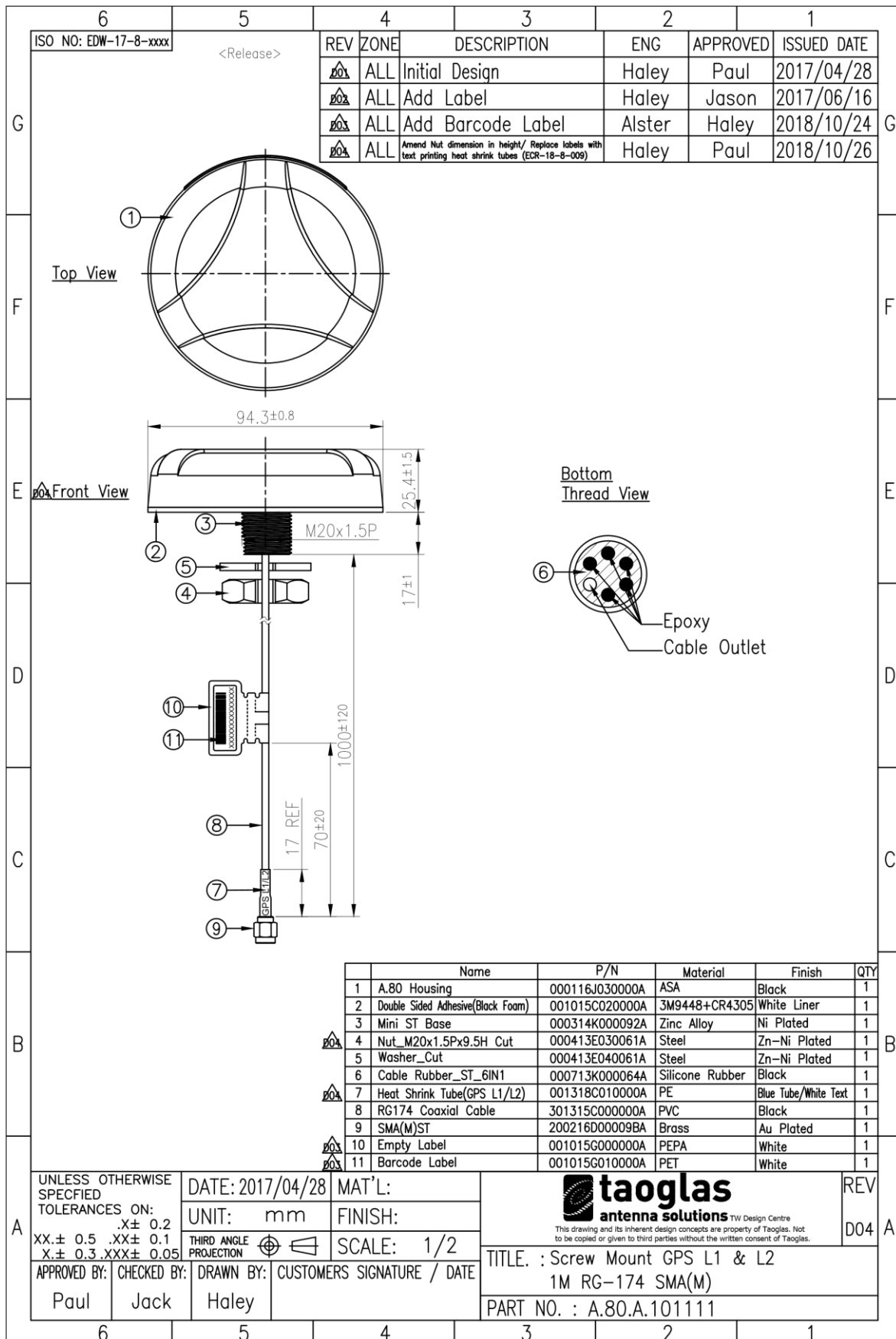

8. Packaging

8.1 A.80.A.101111(Individual Packaging)

1 A.80.A.101111 per PE bag
 Bag Dimensions - 232*183mm
 Total Weight - 283.5g

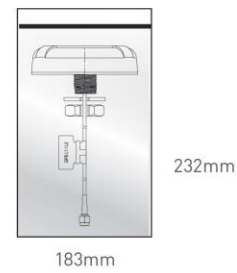

1pcs / PE bags per Inner Carton
 Inner Carton Dimensions - 117*109*58mm
 Weight - 310g

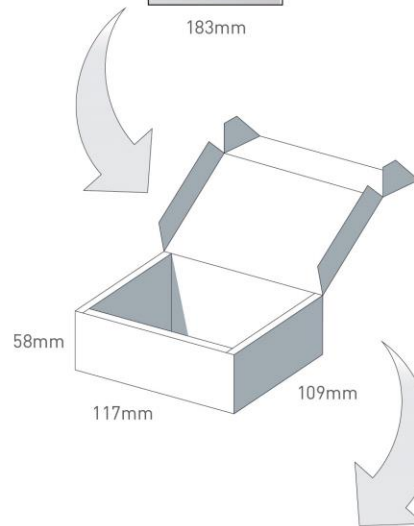

25 Inner Cartons per Outer Carton
 Carton Dimensions - 589*296*135mm
 Weight - 8Kg

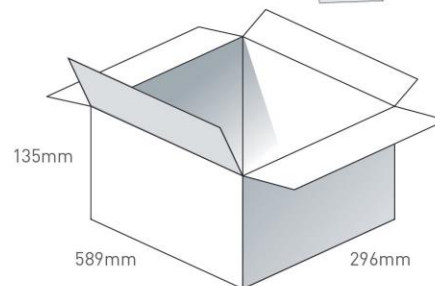

Pallet Dimensions 1200*1000*1420mm
 54 Cartons per pallet
 6 Cartons per layer
 9 Layers

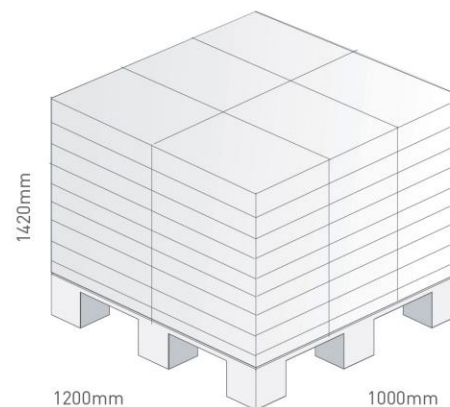

8.2 A.80.A.101111.bp(Bulk Packaging)

1 A.80.A.101111.bp per PE bag
 Bag Dimensions - 232*183mm
 Total Weight - 283.5g

50 pc per Carton in bulk packaging
 Carton Dimensions - 600*340*245mm
 Weight - 13Kg

Pallet Dimensions 1200*1000*1420mm
 20 Cartons per pallet
 4 Cartons per layer
 5 Layers

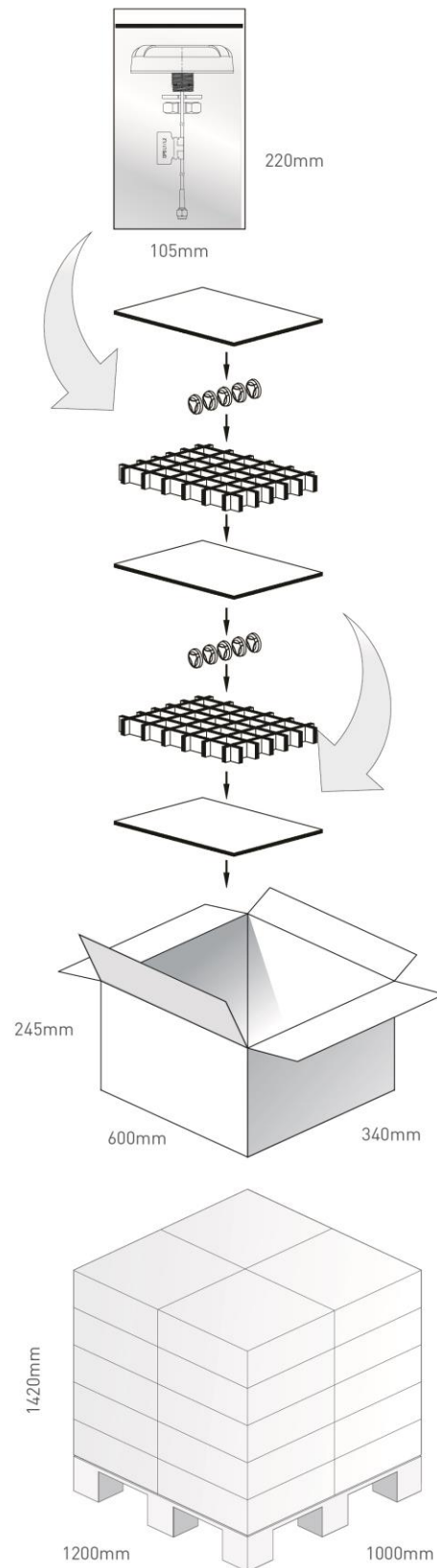

Changelog for the datasheet

SPE-17-8-089 – A.80.101111

Revision: D (Current version)	
Date:	2020-06-02
Changes:	Added Field Test Results
Changes Made by:	Victor Pinazo

Previous Revisions

Revision: C	
Date:	2020-02-21
Changes:	Updated Template and RTK results
Changes Made by:	Yu Kai Yeung

Revision: B	
Date:	2018-10-12
Changes:	Updated Drawing
Changes Made by:	Jack Conroy

Revision: A (Original First Release)	
Date:	2017-11-30
Notes:	Initial Datasheet Release
Author:	David Connolly



TAOGLAS®

www.taoglas.com

