

JOHNSON™

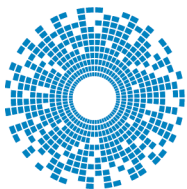

mmWave Catalog



cinch
CONNECTIVITY SOLUTIONS
a bel group

belfuse.com/cinch

About Bel

Bel is a publicly traded company that has been operated by the same family for over 65 years. Our history of organic growth and acquisitions have broadened our product portfolio. This has established Bel as a world leader with a diverse offering of power, protection and interconnect products. We design and manufacture these products which are primarily used in the networking, telecommunications, computing, military, aerospace, transportation and broadcasting industries. Bel's portfolio of products also finds application in the automotive, medical and consumer electronics markets.

About Johnson

Johnson™ designs and manufactures an industry-leading line of RF coaxial connectors and adapters, available in both 50 and 75 Ohm versions, operating up to 67GHz. The range of products available within the Johnson product line includes board and cable mount connectors across subminiature, micro-miniature, ultra-miniature and millimeter wave classes as well as semi-rigid, conformable, and flexible RF coaxial cables. Johnson connectors are designed to provide the highest quality data transmission for data, audio, and video applications.

Table of Contents

1.0mm

Product Specifications	3
End Launch Connectors	4
Sparkplug Connectors	5
Adapters	6

1.85mm

Product Specifications	7
End Launch Connectors	8
Vertical Connectors	9
Low Profile Connectors	9
Same Series Adapters	10
Between Series Adapters	10
Terminations	14

2.4mm

Product Specifications	15
End Launch Connectors	17
Low Profile Connectors	18
Vertical Connectors	19
Flange Connectors	20
Same Series Adapters	21
Between Series Adapters	22
Terminations	24

2.92mm

Product Specifications	25
End Launch Connectors	27
Vertical Connectors	28
Low Profile Connectors	29
Flange Connectors	30
Field Replaceable Connectors	31
Product Specification Table	32
Same Series Adapters	33
Between Series Adapters	34
Terminations	38

Tooling

2.92mm Cabled Connectors	39
--------------------------	----

Application Notes

2.92mm Solder Type Straight Plugs for Semi-Rigid Cables	40
Field Replaceable	41
2.92mm (SMK) End Launch Connectors	43

Product Specifications

The Johnson 1.0mm Series Connector provides an excellent solution for demanding applications requiring high frequency transmission.

- Precision manufacturing allows superior electrical performance > 110 GHz with VSWR performance to > 1.38 Max
- Connector mating interface per > IEEE 287 GPC
- Mating interface control provides consistent electrical performance
- Available in screw-in end launch, panel mount and spark plug connector styles. Same series adapters are also available.

Materials

Bodies	Stainless Steel / Passivated per QQ-S-764
Contacts	Beryllium copper / Gold plated per QQ-C-530
Insulater	ULTEM 1000 Amber, PEEK, PTFE

Environmental

Temperature Range	-65°C to +165°C
Thermal Shock	MIL-STD-202, Method 107, Condition B
Shock	MIL-STD-202, Method 213, Condition I
Vibration	MIL-STD-202, Method 204, Condition D
Moisture Resistance	MIL-STD-202, Method 106

Electrical

Impedance	50 Ohm
Frequency Range	DC to 110 GHz
VSWR	1.38:1 maximum
Working Voltage	150 (VRMS maximum at sea level)
Dielectric Withstanding Voltage	500 (VRMS maximum at sea level)
Insertion Loss	< 0.6 dB
Insulation Resistance	5000 (megohms minimum)
Resistance	Center Contact: 4.0 (milliohms maximum) Outer Contact: 2.5 (milliohms maximum)
Return Loss	-15dB Max DC - 67 GHz -10dB Max 67 - 110 GHz

Mechanical

Engagement Design	IEEE 287 GPC, Series 1.0mm
Engagement/Disengagement Force	0.56 N / 0.28 N Maximum
Mating Torque	0.45 N m
Coupling Proof Torque	0.7 N m
Coupling Nut Retention	220 N Minimum
Contact Retention	10 N Minimum

End Launch Connectors

Jack, Female End Panel End Launch

Part Number	Material	Impedance	Maximum Frequency	VSWR
149-0701-601	Stainless Steel/Passivated	50 Ohms	110 GHz	> 1.38 Max

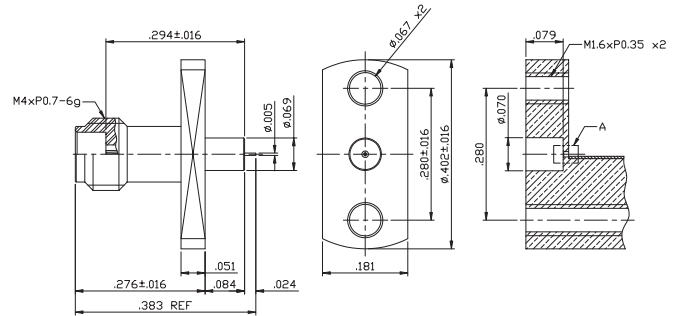

Jack, Screw-on Type, Female End Launch Jack

Part Number	Material	Impedance	Maximum Frequency	VSWR
149-0701-801	Gold-Plated Brass	50 Ohms	110 GHz	> 1.38 Max

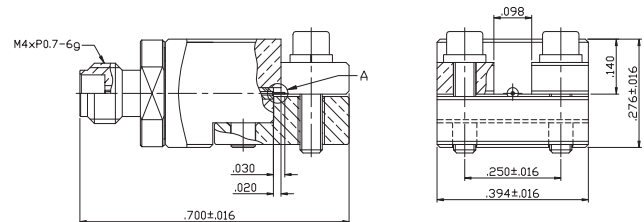
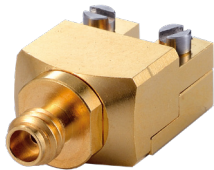

Jack, Screw-on Type, Male End Launch Jack

Part Number	Material	Impedance	Maximum Frequency	VSWR
149-0801-801	Gold-Plated Brass	50 Ohms	110 GHz	> 1.38 Max

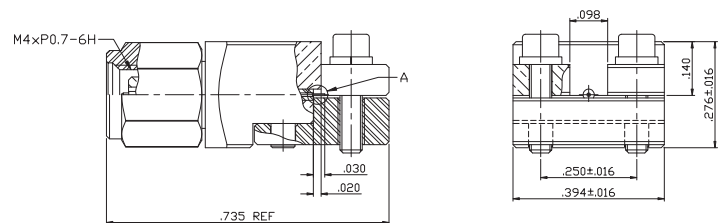
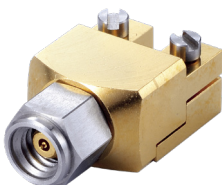

Sparkplug Connectors

Female Sparkplug

Part Number	Material	Impedance	Maximum Frequency	VSWR
149-0701-001	Gold-Plated Brass	50 Ohms	110 GHz	> 1.38 Max

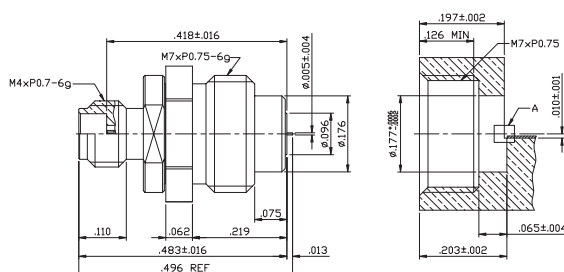

Male Sparkplug

Part Number	Material	Impedance	Maximum Frequency	VSWR
149-0801-001	Gold-Plated Brass	50 Ohms	110 GHz	> 1.38 Max

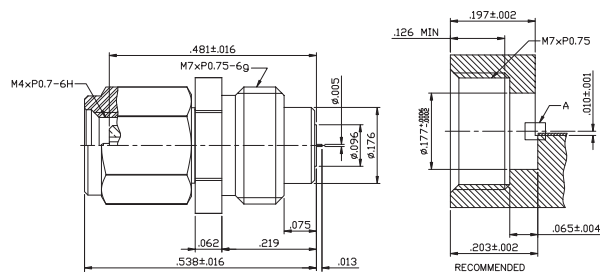

Adapters

Male to Male Adapter

Part Number	Material	Impedance	Maximum Frequency	VSWR
149-0901-801	Shell: Stainless Steel/ Passivated Body: Beryllium Copper/Gold Plated	50 Ohms	110 GHz	> 1.38 Max

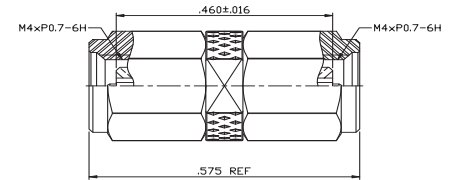

Male to Female Adapter

Part Number	Material	Impedance	Maximum Frequency	VSWR
149-0901-811	Shell: Stainless Steel/ Passivated Body: Beryllium Copper/Gold Plated	50 Ohms	110 GHz	> 1.38 Max

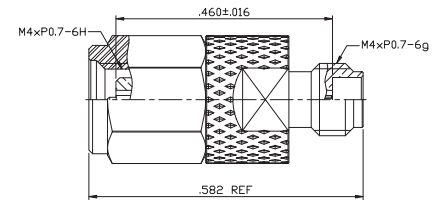

Female to Female Adapter

Part Number	Material	Impedance	Maximum Frequency	VSWR
149-0901-821	Shell: Stainless Steel/ Passivated Body: Beryllium Copper/Gold Plated	50 Ohms	110 GHz	> 1.38 Max

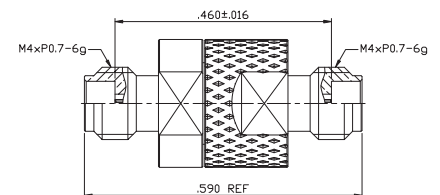

Product Specifications

The Johnson 1.85mm Series Connector provides an excellent solution for demanding applications requiring high frequency transmission.

- Precision manufacturing allows superior electrical performance to 67GHz with VSWR performance to 1.35
- Connector mating interface per IEC 61169-32
- Mating interface control provides consistent electrical performance
- Available in end launch, 2 hole and 4 hole flange mount styles

Materials

Bodies	Stainless steel/passivated per QQ-8-626, gold-plated per MIL-G-45204 0.00005" minimum
Contacts	Female - beryllium copper per QQ-C-530, gold-plated per MIL-G-45204 0.00005" minimum
Insulator	Peek; Ultem 1000, PCTFF, KEL-F

Environmental (Meets or exceeds the applicable paragraph of MIL-C-39012)

Temperature Range	-65°C to +165°C
Thermal Shock	MIL-STD-202, Method 107, Condition B
Corrosion	MIL-STD-202, Method 101, Condition B
Shock	MIL-STD-202, Method 213, Condition I
Vibration	MIL-DTL-202, Method 204, Condition D
Moisture Resistance	MIL-DTL-202, Method 106

Electrical (Meets or exceeds the applicable paragraph of MIL-C-39012)

Impedance	50 Ohm
Frequency Range	0 - 67 GHz
VSWR	1.3 maximum
Working Voltage	150 (VRMS maximum at sea level)
Dielectric Withstanding Voltage	500 (VRMS maximum at sea level)
Insertion Loss	$0.05 \times \sqrt{f \text{ (GHz)}}$ (dB maximum)
Insulation Resistance	5000 (megohms minimum)
Insulation Resistance	Center Contact: 4.0 (milliohms maximum) Outer Contact: 2.5 (milliohms maximum)
RF Leakage	-90dB (dB minimum, tested at 2.5GHz)

Mechanical

Engagement Design	MIL-STD-348, series 1.85mm
Engagement/Disengagement Force	2 inch-pounds maximum
Mating Torque	7 to 10 inch-pounds
Coupling Proof Torque	15 inch-pounds minimum
Coupling Nut Retention	60 pounds minimum
Contact Retention	6 pounds minimum axial force (captivated contacts)

Mating Engagement: 1.85mm Series per MIL-STD-348

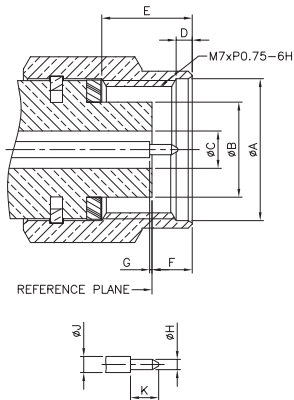

	Plug	
	Minimum	Maximum
A	7.01mm	7.11mm
B	4.72mm	4.75mm
C	1.84mm	1.86mm
D	0.51mm	0.76mm
E	4.37mm	4.62mm
F	1.86mm	2.45mm
G	0	0.08mm
H	0.5mm	0.52mm
J	0.79mm	0.81mm
K	1.34mm	1.44mm

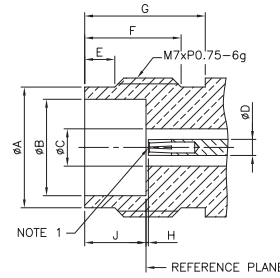

	Jack	
	Minimum	Maximum
A	7.01mm	7.11mm
B	4.72mm	4.75mm
C	1.84mm	1.86mm
D	0.51mm	0.76mm
E	4.37mm	4.62mm
F	1.86mm	2.45mm
G	0	0.08mm
H	0.5mm	0.52mm
J	0.79mm	0.81mm

End Launch Connectors

1.85mm screw-on end launch connectors are designed for use in a variety of applications and markets while delivering superior signal integrity in the most demanding environments. They operate to 67GHz with a VSWR performance up to 1.20. They are easy to assemble and disassemble to a PCB, can be connected with solder or solderless, and adjustable to varying board thicknesses.

Jack, Screw-on Type

Part Number	Material	Impedance	Maximum Frequency	VSWR
148-0701-301	Stainless Steel/Passivated	50 Ohms	67GHz	Typical VSWR 1.20-1.25

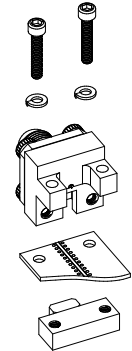
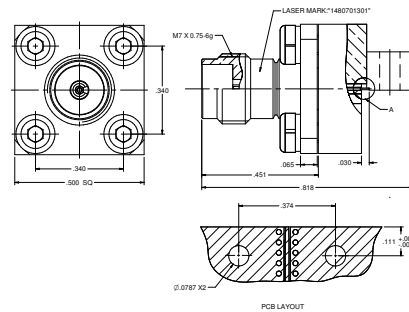

Plug, Screw-on Type

Part Number	Material	Impedance	Maximum Frequency	VSWR
148-0801-301	Stainless Steel/Passivated	50 Ohms	67GHz	Typical VSWR 1.20-1.25

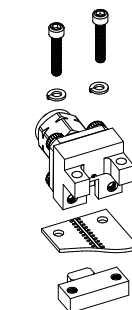
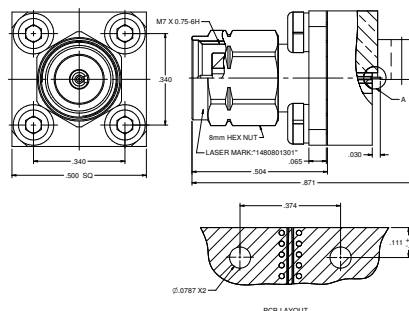
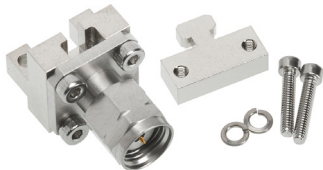

Low Profile Connectors – (at 0.375 Height)

Jack, Screw-on Type, Low profile, 0.005” Pin

Part Number	Material	Impedance	Maximum Frequency	VSWR
148-0701-802	Stainless Steel/Passivated	50 Ohms	67GHz	Typical VSWR 1.20

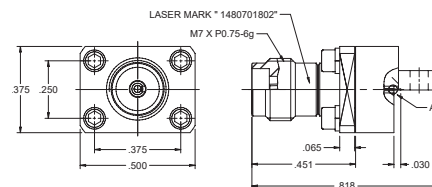

Jack, Screw-on Type, Low profile, 0.007” Pin

Part Number	Material	Impedance	Maximum Frequency	VSWR
148-0701-812	Stainless Steel/Passivated	50 Ohms	67GHz	Typical VSWR 1.20

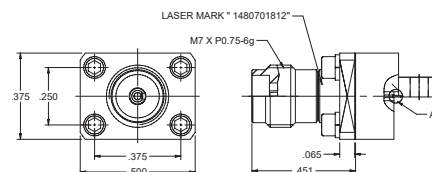

Vertical Connectors

Jack, Vertical Launch Solderless PCB Compression Mount, Stripline

Part Number	Material	Impedance	Maximum Frequency	VSWR
148-0701-202	Stainless Steel/Passivated	50 Ohms	67GHz	Typical VSWR 1.20

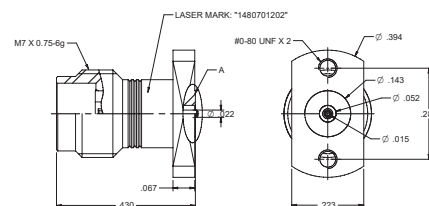

Jack, Vertical Launch Solderless PCB Compression Mount, Microstrip

Part Number	Material	Impedance	Maximum Frequency	VSWR
148-0701-212	Stainless Steel/Passivated	50 Ohms	50GHz	Typical VSWR 1.20

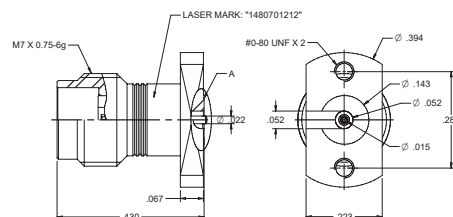

Same Series Adapters

1.85mm same series adapters are precision manufactured to RF component industry specifications, with a maximum frequency of 67GHz, and VSWR up to 1.20. Available in jack to jack, jack to plug, and plug to plug configurations.

Plug to Plug Adapter

Part Number	Material	Impedance	Maximum Frequency	VSWR
148-0901-701	Stainless Steel/Passivated	50 Ohms	67GHz	1.20

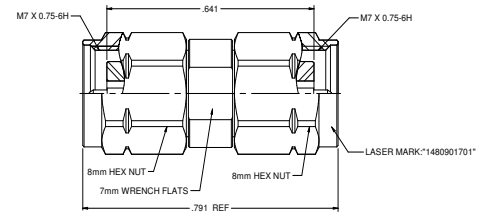

Plug to Jack Adapter

Part Number	Material	Impedance	Maximum Frequency	VSWR
148-0901-711	Stainless Steel/Passivated	50 Ohms	67GHz	1.20

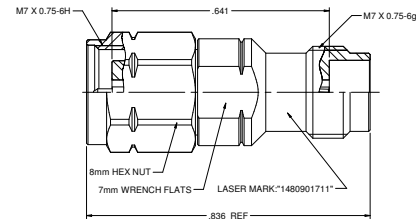

Jack to Jack Adapter

Part Number	Material	Impedance	Maximum Frequency	VSWR
148-0901-721	Stainless Steel/Passivated	50 Ohms	67GHz	1.20

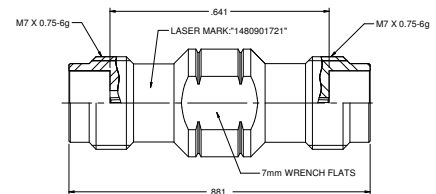

Between Series Adapters

1.85mm between series adapters are precision manufactured to RF component industry specifications, and adapt to the 2.4mm and SMPM standards, with a maximum frequency of 50 and 65GHz, and VSWR of 1.15-1.25. Available in jack to jack, jack to plug, plug to jack and plug to plug configurations.

Adapter Assembly, 1.85mm Jack to 2.4mm Jack

Part Number	Material	Impedance	Maximum Frequency	VSWR
134-1000-016	Stainless Steel/Passivated	50 Ohms	67GHz	1.15

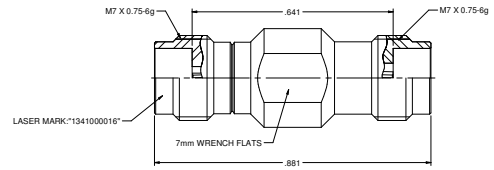

Adapter Assembly, 1.85mm Jack to 2.4mm Plug

Part Number	Material	Impedance	Maximum Frequency	VSWR
148-0901-711	Stainless Steel/Passivated	50 Ohms	67GHz	1.15

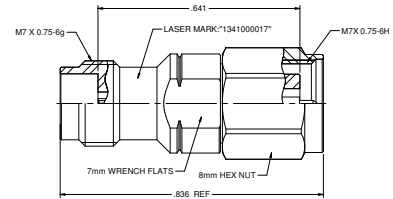

Adapter Assembly, 1.85mm Plug to 2.4mm Jack

Part Number	Material	Impedance	Maximum Frequency	VSWR
134-1000-018	Stainless Steel/Passivated	50 Ohms	50GHz	1.15

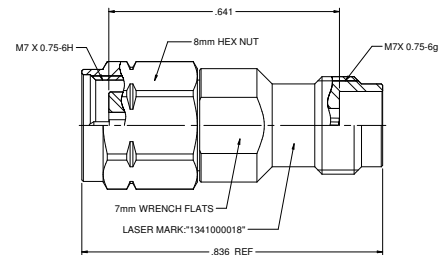

Adapter Assembly, 1.85mm Plug to 2.4mm Plug

Part Number	Material	Impedance	Maximum Frequency	VSWR
134-1000-019	Stainless Steel/Passivated	50 Ohms	50GHz	1.15

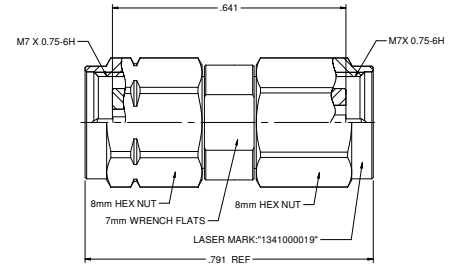

Adapter Assembly, 1.85mm Jack to 2.92mm Jack

Part Number	Material	Impedance	Maximum Frequency	VSWR
134-1000-020	Stainless Steel/Passivated	50 Ohms	46.5Hz	1.15

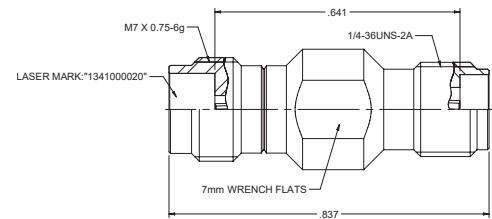

Adapter Assembly, 1.85mm Jack to 2.92mm Plug

Part Number	Material	Impedance	Maximum Frequency	VSWR
134-1000-021	Stainless Steel/Passivated	50 Ohms	46.5Hz	1.15

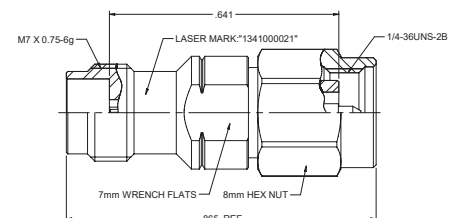

Adapter Assembly, 1.85mm Plug to 2.92mm Jack

Part Number	Material	Impedance	Maximum Frequency	VSWR
134-1000-022	Stainless Steel/Passivated	50 Ohms	46.5Hz	1.15

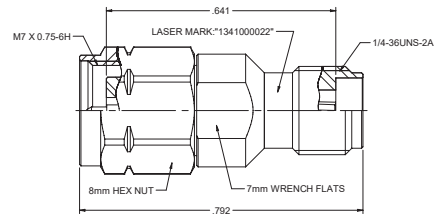

Adapter Assembly, 1.85mm Plug to 2.92mm Pkug

Part Number	Material	Impedance	Maximum Frequency	VSWR
134-1000-023	Stainless Steel/Passivated	50 Ohms	46.5Hz	1.15

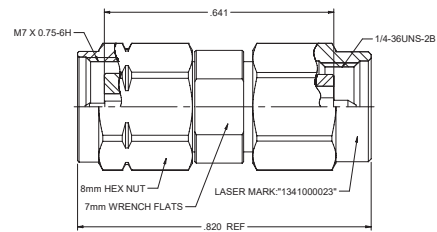

Adapter Assembly, 1.85mm Jack to SMPM Female

Part Number	Material	Impedance	Maximum Frequency	VSWR
134-1000-024	Stainless Steel/Passivated	50 Ohms	65GHz	1.25

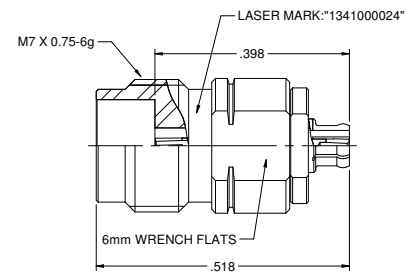

Adapter Assembly, 1.85mm Jack to SMPM Male (Full Detent)

Part Number	Material	Impedance	Maximum Frequency	VSWR
134-1000-025	Stainless Steel/Passivated	50 Ohms	65GHz	1.25

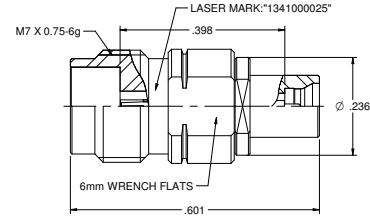

Adapter Assembly, 1.85mm Plug to SMPM Female

Part Number	Material	Impedance	Maximum Frequency	VSWR
134-1000-026	Stainless Steel/Passivated	50 Ohms	65GHz	1.25

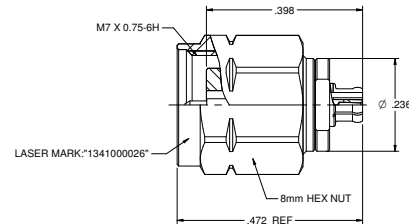
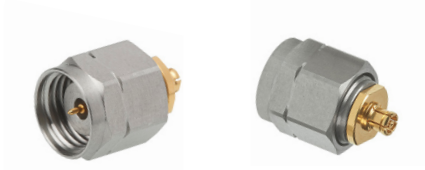

Adapter Assembly, 1.85mm Plug to SMPM Male (Full Detent)

Part Number	Material	Impedance	Maximum Frequency	VSWR
134-1000-027	Stainless Steel/Passivated	50 Ohms	65GHz	1.25

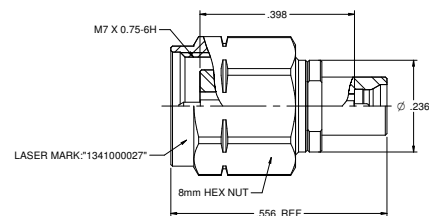
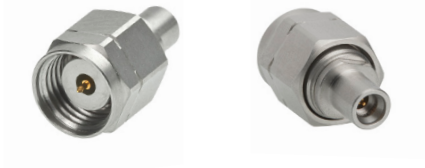

Terminations

Termination Plug (1/4 Watts) Same Series

Part Number	Material	Impedance	Maximum Frequency	VSWR
148-0801-801	Stainless Steel/Passivated	50 Ohms	67GHz	1.30

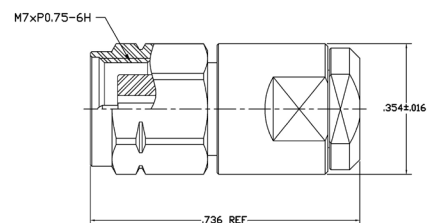

Product Specifications

The Johnson 2.4mm Series Connector provides an excellent solution for demanding applications requiring high frequency transmission.

- Precision manufacturing allows superior electrical performance with maximum VSWR of 1.30 at 50 GHz
- Connector mating interface per MIL-STD-348, and intermateable with 1.85mm connector series.
- Mating interface control provides consistent electrical performance
- Available in end launch, 2 hole and 4 hole flange mount styles

Materials

Bodies	Stainless steel/passivated per QQ-8-626, gold-plated per MIL-G-45204 0.00005" minimum
Contacts	Female - beryllium copper per QQ-C-530, gold-plated per MIL-G-45204 0.00005" minimum
Insulator	Peek; Ultem 1000, PCTFF, KEL-F

Environmental (Meets or exceeds the applicable paragraph of MIL-C-39012)

Temperature Range	-65°C to +165°C
Thermal Shock	MIL-STD-202, Method 107, Condition B
Corrosion	MIL-STD-202, Method 101, Condition B
Shock	MIL-STD-202, Method 213, Condition I
Vibration	MIL-DTL-202, Method 204, Condition D
Moisture Resistance	MIL-DTL-202, Method 106

Electrical

Impedance	50 Ohm
Frequency Range	0 - 50 GHz
VSWR	1.25 maximum
Working Voltage	150 (VRMS Maximum)
Dielectric Withstanding Voltage	500 (VRMS minimum)
Insertion Loss	0.05 x f (GHz), dB maximum
Insulation Resistance	5000 (megohms minimum)
Contact Resistance	Center Contact: 4.0 (milliohms maximum) Outer Contact: 2.5 (milliohms maximum)
RF Leakage	-90dB (dB minimum, tested at 2.5GHz)

Mechanical

Engagement Design	MIL-STD-348, series 2.4mm
Engagement/Disengagement Force	2 inch-pounds maximum
Mating Torque	7 to 10 inch-pounds
Coupling Proof Torque	15 inch-pounds minimum
Coupling Nut Retention	60 pounds minimum
Contact Retention	6 pounds minimum axial force (captivated contacts)

Mating Engagements 2.4mm Series per MIL-STD-348

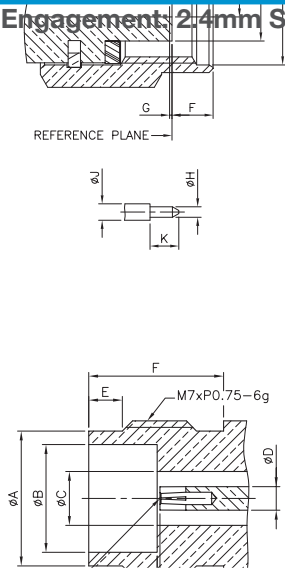

Plug	Minimum	Maximum
A	7.01mm	7.11mm
B	4.72mm	4.75mm
C	2.39mm	2.41mm
D	0.51mm	0.76mm
E	3.56mm	3.81mm
F	1.85mm	2.67mm
G	0mm	0.08mm
H	0.5mm	0.52mm
J	1.03mm	1.05mm
K	1.35mm	1.45mm

Jack	Minimum	Maximum
A	5.79mm	5.89mm
B	4.77mm	4.79mm
C	2.39mm	2.41mm
D	1.03mm	1.05mm
E	1.40mm	1.65mm
F	5.99mm	-
G	0mm	0.08mm
H	3mm	3.1mm

Part Number	Material	Impedance	Maximum Frequency	VSWR
147-0701-201	Stainless Steel/Passivated	50 Ohms	50GHz	Typical VSWR 1.20

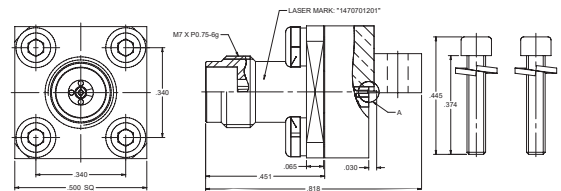

Plug, Screw-On Type

Part Number	Material	Impedance	Maximum Frequency	VSWR
147-0801-201	Stainless Steel/Passivated	50 Ohms	50GHz	Typical VSWR 1.20-1.25

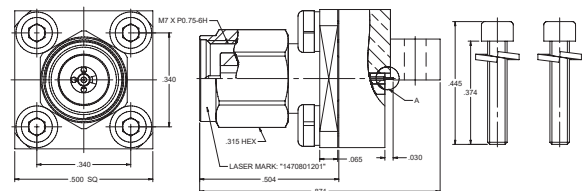

Jack, 0.062" Board thickness, Solder Type

Part Number	Material	Impedance	Maximum Frequency	VSWR
147-0701-241	Gold-Plated Brass	50 Ohms	50GHz	Typical VSWR 1.5

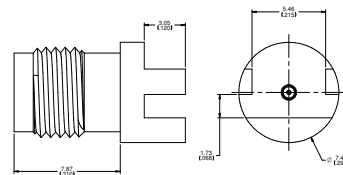

PC Mount Jack, Thru-Hole, Round Body, Solder Type

Part Number	Material	Impedance	Maximum Frequency	VSWR
147-0701-251	Gold-Plated Brass	50 Ohms	50GHz	Typical VSWR 1.5

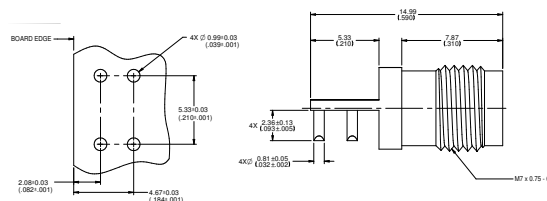

Jack, 0.042" Board thickness, Solder Type

Part Number	Material	Impedance	Maximum Frequency	VSWR
147-0701-261	Gold-Plated Brass	50 Ohms	50GHz	Typical VSWR 1.5

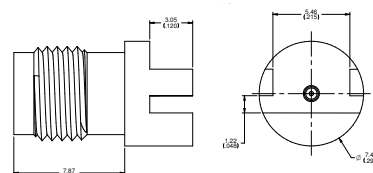

Jack, 0.093" Board thickness, Solder Type

Part Number	Material	Impedance	Maximum Frequency	VSWR
147-0701-271	Gold-Plated Brass	50 Ohms	50GHz	Typical VSWR 1.5

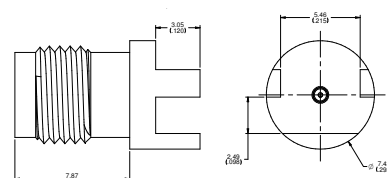

Low Profile Connectors – (at 0.375 Height)

Jack, Screw-on Type, Low profile, 0.005" Pin

Part Number	Material	Impedance	Maximum Frequency	VSWR
147-0701-822	Stainless Steel/Passivated	50 Ohms	50GHz	Typical VSWR 1.20

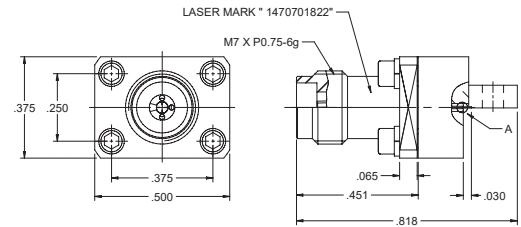

Jack, Screw-on Type, Low profile, 0.007" Pin

Part Number	Material	Impedance	Maximum Frequency	VSWR
147-0701-832	Stainless Steel/Passivated	50 Ohms	50GHz	Typical VSWR 1.20

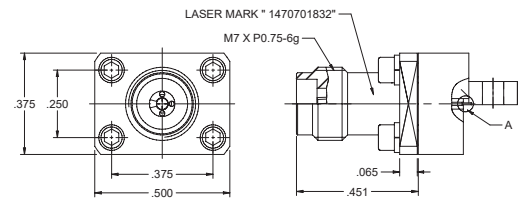
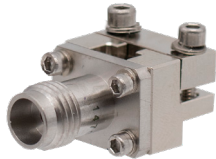

Vertical Mount Connectors

Jack, Vertical 2-Hole Flange PCB Compression Mount, Stripline

Part Number	Material	Impedance	Maximum Frequency	VSWR
147-0701-211	Stainless Steel/Passivated	50 Ohms	50GHz	Typical VSWR 1.20

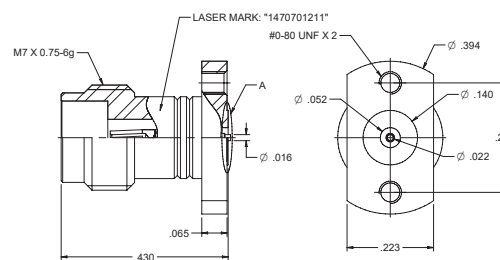

Jack, Vertical 2-Hole Flange PCB Compression Mount, Microstrip

Part Number	Material	Impedance	Maximum Frequency	VSWR
147-0701-222	Stainless Steel/Passivated	50 Ohms	50GHz	Typical VSWR 1.20

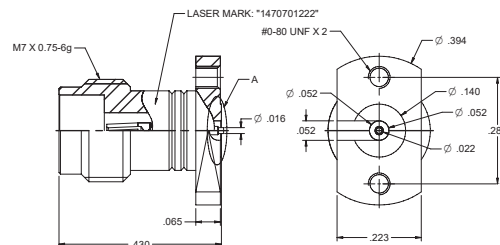

Flange Connectors

Plug, 2-Hole Flange Mount Jack Receptacle

Part Number	Material	Impedance	Maximum Frequency	VSWR
147-0701-601	Stainless Steel/Passivated	50 Ohms	50GHz	Typical VSWR 1.20

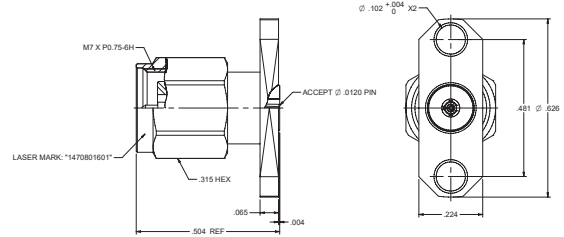

2-Hole Flange Mount Plug Receptacle

Part Number	Material	Impedance	Maximum Frequency	VSWR
147-0801-601	Stainless Steel/Passivated	50 Ohms	50GHz	Typical VSWR 1.20

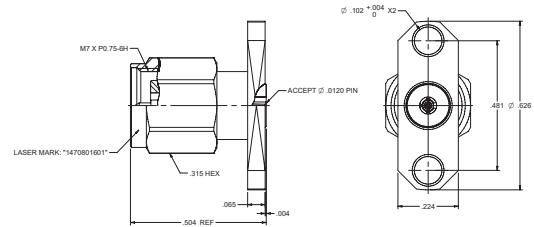

4-Hole Flange Mount Jack and Plug Receptacle

Part Number	Material	Impedance	Maximum Frequency	VSWR
147-0701-611	Stainless Steel/Passivated	50 Ohms	50GHz	1.20
147-0801-611	Stainless Steel/Passivated	50 Ohms	50GHz	1.20

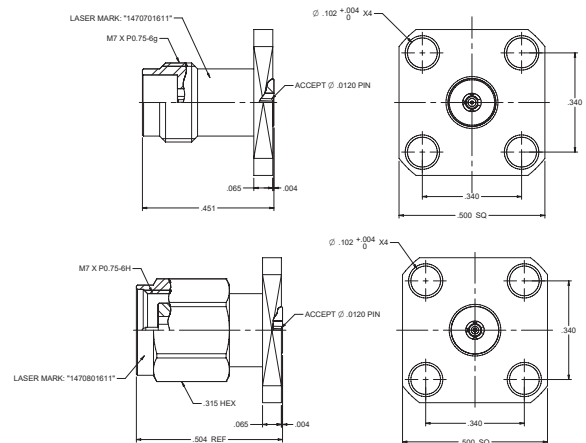

Same Series Adapters

Plug to Plug Same Series Adapter

Part Number	Material	Impedance	Maximum Frequency	VSWR
147-0801-201	Stainless Steel/Passivated	50 Ohms	50GHz	Typical VSWR 1.20-1.25

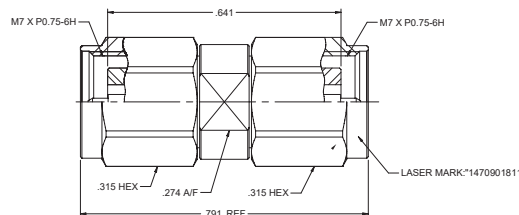
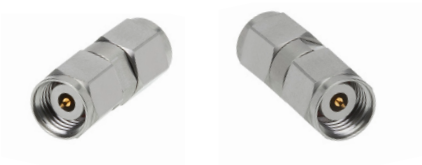

Plug to Jack Same Series Adapter

Part Number	Material	Impedance	Maximum Frequency	VSWR
147-0901-801	Stainless Steel/Passivated	50 Ohms	50GHz	1.20

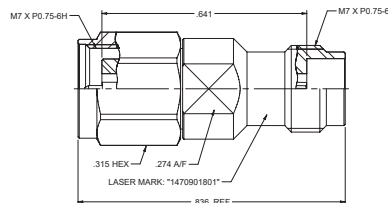

Jack to Jack Same Series Adapter

Part Number	Material	Impedance	Maximum Frequency	VSWR
147-0901-821	Stainless Steel/Passivated	50 Ohms	50GHz	Typical VSWR 1.20

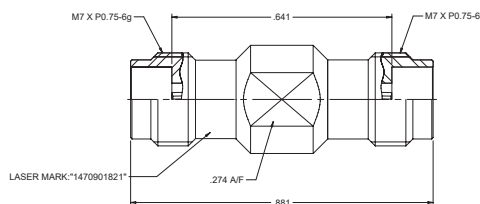

Right Angle Jack to Jack Same Series Adapter

Part Number	Material	Impedance	Maximum Frequency	VSWR
147-0901-901	Stainless Steel/Passivated	50 Ohms	50GHz	Typical VSWR 1.20

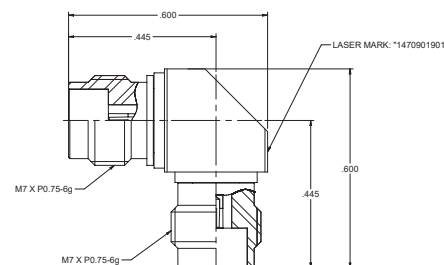

Between Series Adapters

Between Series, 2.4mm Jack to 2.92mm Jack

Part Number	Material	Impedance	Maximum Frequency	VSWR
134-1000-008	Stainless Steel/Passivated	50 Ohms	40GHz	DC - 4GHz 1.05
				4 - 20GHz 1.08
				20 - 40GHz 1.15

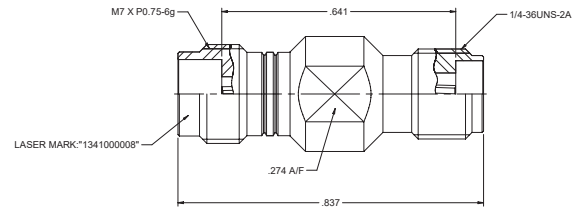

Between Series, 2.4mm Jack to 2.92mm Plug

Part Number	Material	Impedance	Maximum Frequency	VSWR
134-1000-009	Stainless Steel/Passivated	50 Ohms	40GHz	DC - 4GHz 1.05
				4 - 20GHz 1.08
				20 - 40GHz 1.15

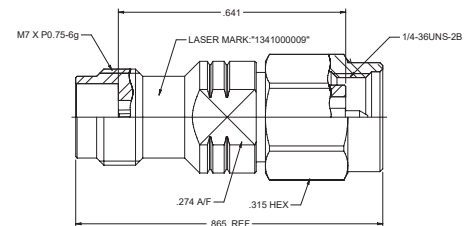

Between Series, 2.4mm Plug to 2.92mm Jack

Part Number	Material	Impedance	Maximum Frequency	VSWR
134-1000-010	Stainless Steel/Passivated	50 Ohms	40GHz	DC - 4GHz 1.05
				4 - 20GHz 1.08
				20 - 40GHz 1.15

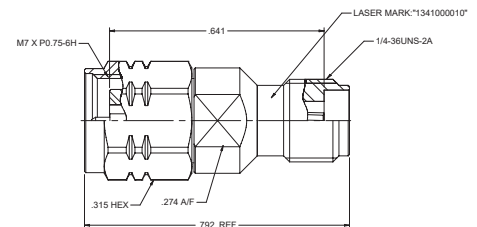
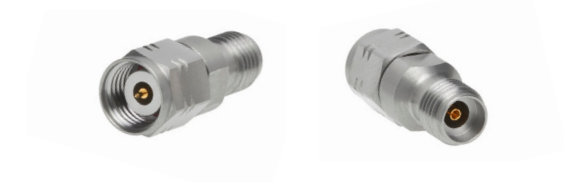

Between Series, 2.4mm Plug to 2.92mm Plug

Part Number	Material	Impedance	Maximum Frequency	VSWR
134-1000-0011	Stainless Steel/Passivated	50 Ohms	40GHz	DC - 4GHz 1.05 4 - 20GHz 1.08 20 - 40GHz 1.15

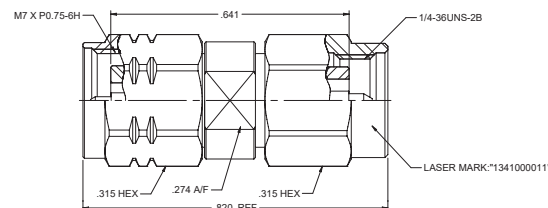

Between Series, 2.4mm Jack To SMP Female

Part Number	Material	Impedance	Maximum Frequency	VSWR
134-1000-012	Stainless Steel/Passivated	50 Ohms	40GHz	1.25

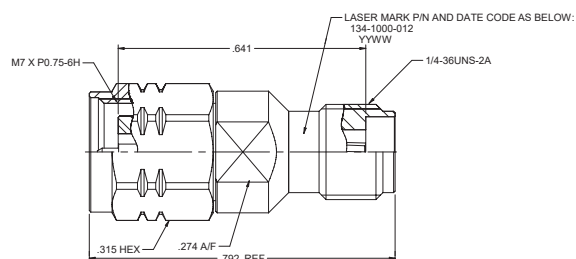

Between Series, 2.4mm Jack To SMP Female

Part Number	Material	Impedance	Maximum Frequency	VSWR
134-1000-013	Stainless Steel/Passivated	50 Ohms	40GHz	1.25

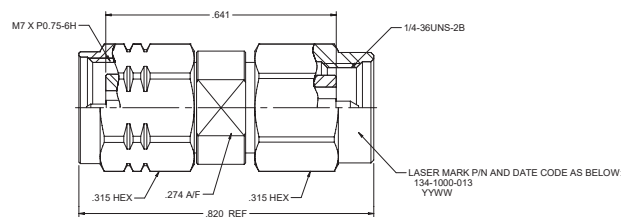

Between Series, 2.4mm Plug To SMP Female

Part Number	Material	Impedance	Maximum Frequency	VSWR
134-1000-014	Stainless Steel/Passivated	50 Ohms	40GHz	1.25

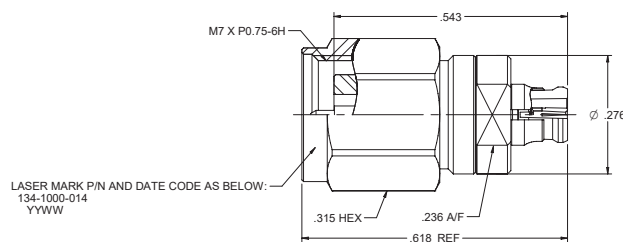

Between Series, 2.4mm Plug To SMP Male (Limited Detent)

Part Number	Material	Impedance	Maximum Frequency	VSWR
134-1000-015	Stainless Steel/Passivated	50 Ohms	40GHz	1.25

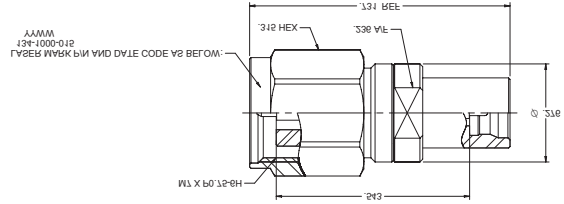
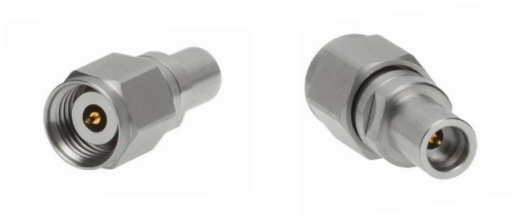

Terminations

Termination Jack (1/4 Watts) Same Series

Part Number	Material	Impedance	Maximum Frequency	VSWR
147-0701-801	Stainless Steel/Passivated	50 Ohms	50GHz	1.30

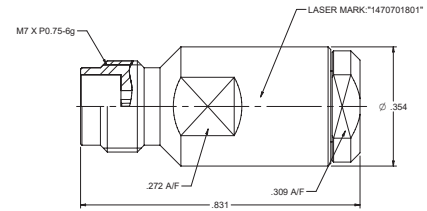

Termination Plug (1/4 Watts) Same Series

Part Number	Material	Impedance	Maximum Frequency	VSWR
147-0801-801	Stainless Steel/Passivated	50 Ohms	50GHz	1.30

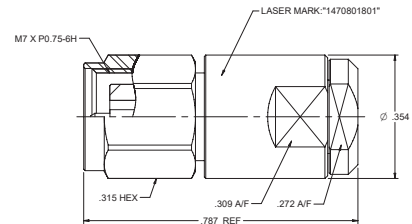

Product Specifications

The Johnson 2.92mm Series Connector provides an excellent solution for demanding applications requiring high frequency transmission. 2.92mm connectors have a smaller internal body diameter than SMA, utilizing an air dielectric.

- Precision manufactured for superior electrical performance to 40GHz
- Connector mating interface per IEC 61169-35, and intermateable with 3.5mm and SMA connectors
- Female contacts in Jack connectors, have a unique three-slot construction, which enhances connectivity by creating a more rugged connector while reducing the chance of intermittent connections
- The field replaceable jacks are teamed with a high quality hermetic seal feed thru for use in sealed circuit modules
- The plug connector VSWR is 1.20 maximum to 40GHz and a 12 inch 2.92mm plug to plug cable assembly performs better than 1.35 VSWR to 40GHz
- The 2.92mm plug interface employs more precise dimensions than an SMA and uses a shorter snub nose male pin such that the connector bodies align before the contacts engage
- Precise assembly tooling assures excellent, repeatable contact and support bead location on cabled connectors
- Available in screw on type and solder type end launch, 2 hole and 4 hole flange mount styles

Materials

Bodies	Stainless steel/passivated per QQ-B-626, gold plated per MIL-G-45204 0.00005in minimum or stainless steel/passivated per MIL-F-14072 B (EL) 300
Contacts	Female - beryllium copper per QQ-C-530, gold plated per MIL-G-45204 0.00005in minimum
Contact Support Beads	PTFE fluorocarbon per ASTM D 1710 and ASTM D 1457 or modified PPE resin
Seal Rings	Silicone rubber per A-A-59588

Environmental (Meets or exceeds the applicable paragraph of MIL-C-39012 [S/S BY MIL-PRF-39012D])

Temperature Range	-85°F to +329°F (-65°C to +165°C)	
Thermal Shock	MIL-STD-202, Method 107, Condition B	
Corrosion	MIL-STD-202, Method 101, Condition B	
Shock	MIL-STD-202, Method 213, Condition I	
Vibration	MIL-STD-202, Method 204, Condition D	
Moisture Resistance	MIL-STD-202, Method 106	
Dielectric Withstanding Voltage		
0.086 Semi-Rigid and Field Replaceable	1000 (VRMS minimum at sea level)	
0.141 Semi-Rigid and Adapters	500 (VRMS minimum at sea level)	
Corona Level		
0.086 Semi-Rigid and Field Replaceable	250 (volts minimum at 70,000 feet)	
0.141 Semi-Rigid and Adapters	375 (volts minimum at 70,000 feet)	
Insertion Loss		
Adapters	0.06 x $\sqrt{f(\text{GHz})}$, tested at 6GHz (dB maximum)	
Straight Semi-Rigid Cable Connectors	0.03 x $\sqrt{f(\text{GHz})}$, tested at 10GHz (dB maximum)	
Insulation Resistance	5,000 megohms minimum	
Contact Resistance	Initial	After Environmental
Center Contact Straight Cabled Connectors	3.0 (milliohms maximum)	4.0 (milliohms maximum)
Center Contact Adapters	4.0 (milliohms maximum)	6.0 (milliohms maximum)
Field Replaceable Connectors	6.0 (milliohms maximum)	8.0 (milliohms maximum)
Outer Contact (all connectors)	2.0 (milliohms maximum)	n/a (milliohms maximum)
Body to Cable (gold plated connectors)	0.5 (milliohms maximum)	n/a (milliohms maximum)
Body to Cable (passivated connectors)	5.0 (milliohms maximum)	n/a (milliohms maximum)
RF Leakage	-90 dB (dB minimum, tested at 2.5GHz)	
RF High Potential Withstanding Voltage		
0.086 Semi-Rigid and Field Replaceable	670 (VRMS minimum tested at 4 and 7MHz)	
0.141 Semi-Rigid and Adapters	1000 (VRMS minimum tested at 4 and 7MHz)	

Mechanical

Engagement Design	MIL-STD-348, series 2.92mm	
Engagement/Disengagement Force	2 inch-pounds maximum	
Mating Torque	7 to 10 inch-pounds	
Coupling Proof Torque	15 inch-pounds minimum	
Coupling Nut Retention	60 pounds minimum	
Contact Retention	6 pounds minimum axial force (captivated contacts)	
Cable Retention	Axial Force (lbs)	Torque (in-oz)
0.086 Semi-Rigid	30	16
0.141 Semi-Rigid	60	55

Note: ID of female contact shall meet VSWR and connectivity requirements when mated with dia. 0.0355-0.0365 male pin
 *See typical return loss graph on next page

Mating Engagement: 2.92mm Series per MIL-STD-348

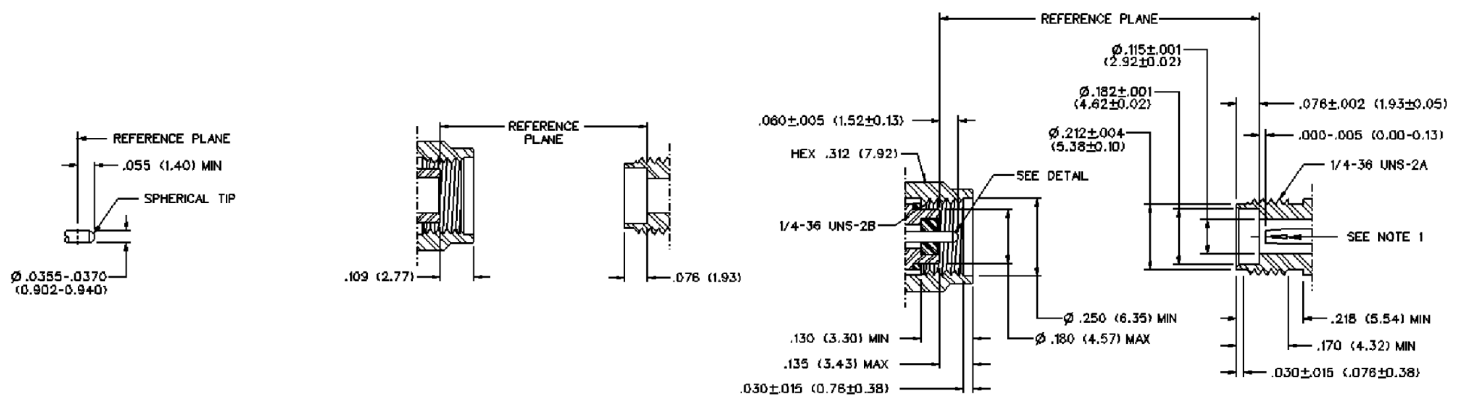

For more information, please see the drawings on the Cinch website at belfuse.com/Cinch and search by part number.

End Launch Connectors

Jack, 0.016" Board Thickness, Straddle Mount, Solder Type

Part Number	Material	Impedance	Maximum Frequency	VSWR
145-0701-821	Gold-Plated Brass	50 Ohms	40GHz	1.25 MAX DC-26.5GHz 1.5 MAX 26.5GHz-40GHz

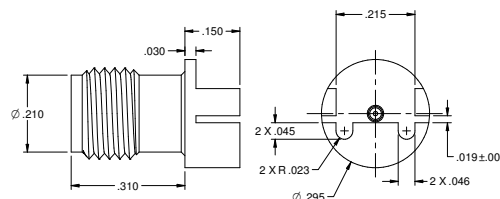

Jack, 0.062" Board Thickness, Straddle Mount, Solder Type

Part Number	Material	Impedance	Maximum Frequency	VSWR
145-0701-841	Gold-Plated Brass	50 Ohms	40GHz	1.25 MAX DC-26.5GHz 1.5 MAX 26.5GHz-40GHz

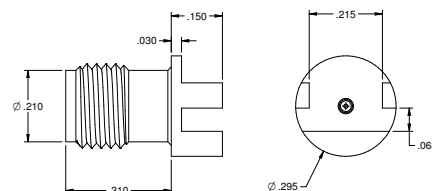

Jack, 0.042" Board Thickness, Straddle Mount, Solder Type

Part Number	Material	Impedance	Maximum Frequency	VSWR
145-0701-851	Gold-Plated Brass	50 Ohms	40GHz	1.25 MAX DC-26.5GHz 1.5 MAX 26.5GHz-40GHz

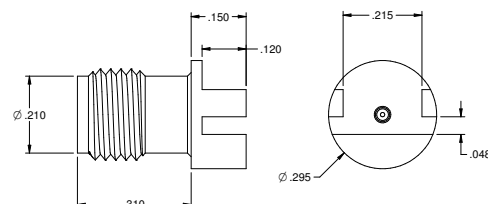

Jack, 0.093" Board Thickness, Straddle Mount, Solder Type

Part Number	Material	Impedance	Maximum Frequency	VSWR
145-0701-861	Gold-Plated Brass	50 Ohms	40GHz	1.25 MAX DC-26.5GHz 1.5 MAX 26.5GHz-40GHz

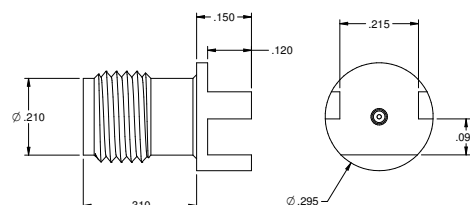

For more information, please see the drawings on the Cinch website at belfuse.com/Cinch and search by part number.

2.92mm

Jack, End Launch, Board Cutout

Part Number	Material	Impedance	Maximum Frequency	VSWR
145-0701-811	Gold-Plated Brass	50 Ohms	40GHz	1.25 MAX DC-26.5GHz 1.5 MAX 26.5GHz-40GHz

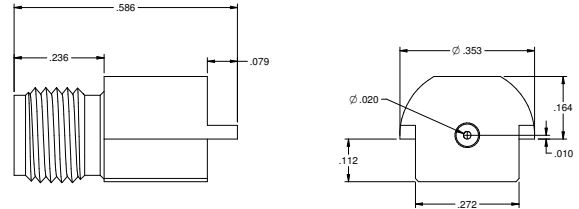
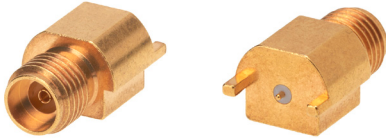

2.92mm Jack, PCB Mount

Part Number	Material	Impedance	Maximum Frequency	VSWR
145-0701-221	Gold-Plated Brass	50 Ohms	40GHz	1.25 MAX DC-26.5GHz 1.5 MAX 26.5GHz-40GHz

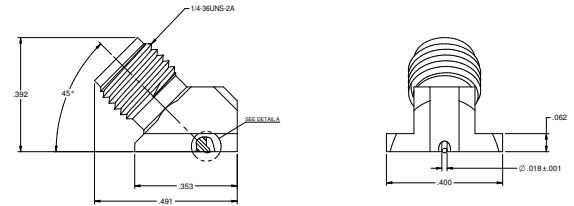

45° PCB Mount Connector

Part Number	Material	Impedance	Maximum Frequency	VSWR
142-0711-271	Gold-Plated Brass	50 Ohms	18GHz	1.25 MAX DC-26.5GHz

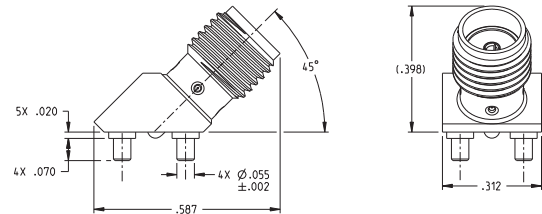
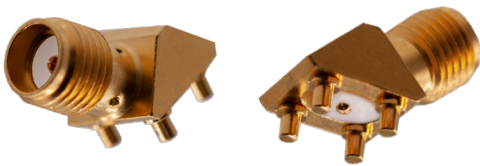

Jack, Screw-On Type

Part Number	Material	Impedance	Maximum Frequency	VSWR
145-0701-802	Stainless Steel/Passivated	50 Ohms	40GHz	1.25 MAX DC-26.5GHz 1.5 MAX 26.5GHz-40GHz

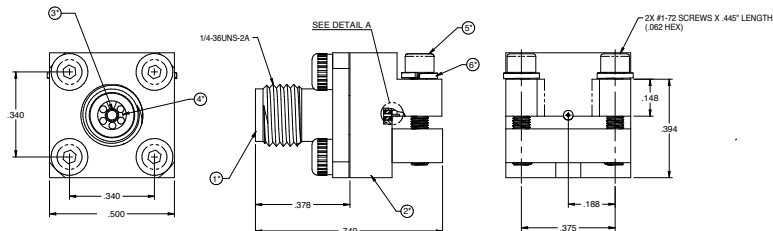

Plug, Screw-On Type

Part Number	Material	Impedance	Maximum Frequency	VSWR
145-0801-802	Stainless Steel/Passivated	50 Ohms	40GHz	1.25 MAX DC-26.5GHz 1.5 MAX 26.5GHz-40GHz

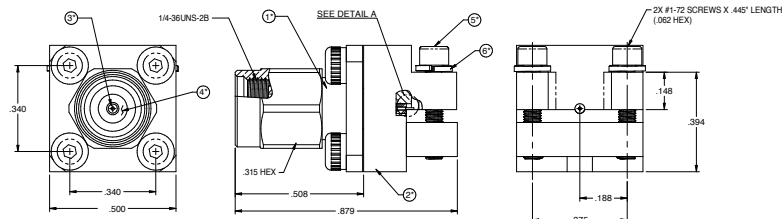

Low Profile Connectors – (at 0.375" Height)

Jack, Screw-on Type, Low profile, 0.005" Pin

Part Number	Material	Impedance	Maximum Frequency	VSWR
145-0711-802	Stainless Steel/Passivated	50 Ohms	40GHz	1.25

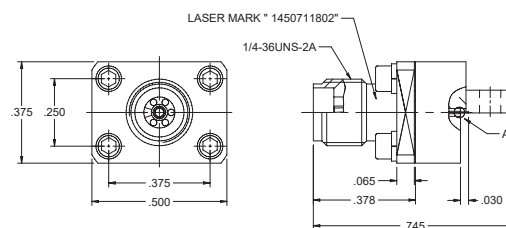
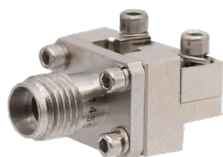

Jack, Screw-on Type, Low profile, 0.007" Pin

Part Number	Material	Impedance	Maximum Frequency	VSWR
145-0711-812	Stainless Steel/Passivated	50 Ohms	40GHz	1.25

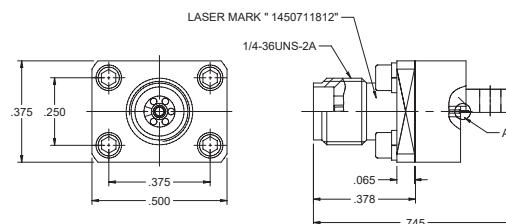
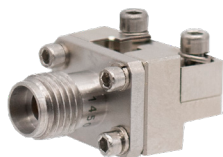

For more information, please see the drawings on the Cinch website at belfuse.com/Cinch and search by part number.

Vertical Connectors

2-Hole Flange Mount Jack, PCB Compression Mount, Stripline

Part Number	Material	Impedance	Maximum Frequency	VSWR
145-0701-202	Stainless Steel/Passivated	50 Ohms	40GHz	1.25

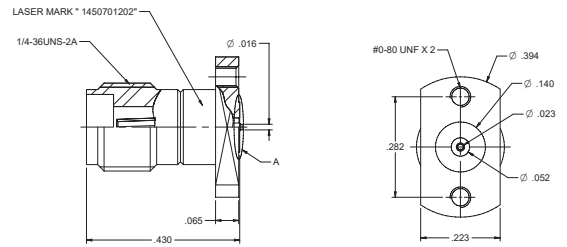

2-Hole Flange Mount Jack, PCB Compression Mount, Microstrip

Part Number	Material	Impedance	Maximum Frequency	VSWR
145-0701-212	Stainless Steel/Passivated	50 Ohms	40GHz	1.25

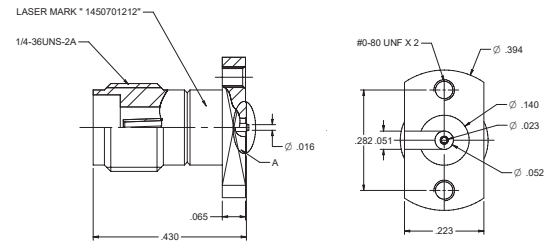

Flange Connectors

2-Hole Flange Mount Jack and Plug Receptacle, Stripline

Part Number	Material	Impedance	Maximum Frequency	VSWR
145-0701-601	Stainless Steel/Gold Plated	50 Ohms	40GHz	1.20
145-0701-602	Stainless Steel/Passivated	50 Ohms	40GHz	1.20
145-0801-602	Stainless Steel/Passivated	50 Ohms	40GHz	1.20

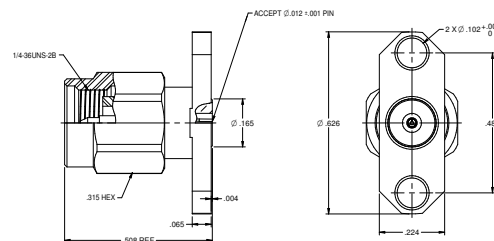
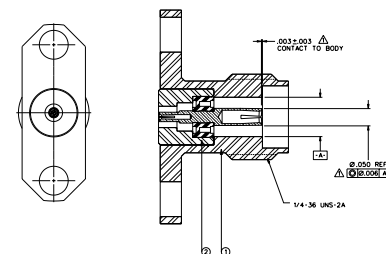
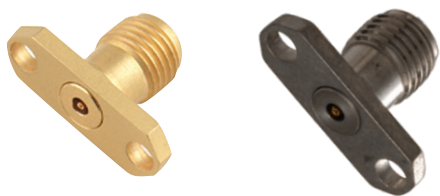

4-Hole Flange Mount Jack and Plug Receptacle

Part Number	Material	Impedance	Maximum Frequency	VSWR
145-0701-611	Stainless Steel/Gold Plated	50 Ohms	40GHz	1.20
145-0701-612	Stainless Steel/Passivated	50 Ohms	40GHz	1.20
145-0801-612	Stainless Steel/Passivated	50 Ohms	40GHz	1.20

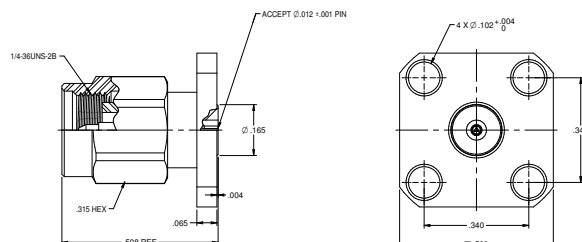
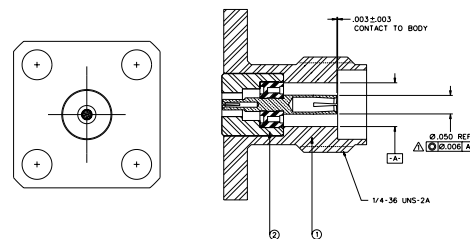
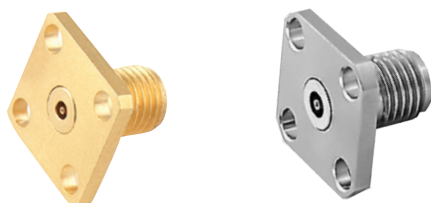

Field Receptacle Connectors

Jack Receptacle, Thread Mount Field Replaceable

Part Number	Accepts Pin Size	Material
145-0701-001	0.0120 in +/- 0.0005 (0.305 +/- 0.013mm)	Stainless Steel/Gold Plated
145-0701-002	0.0120 in +/- 0.0005 (0.305 +/- 0.013mm)	Stainless Steel/Passivated

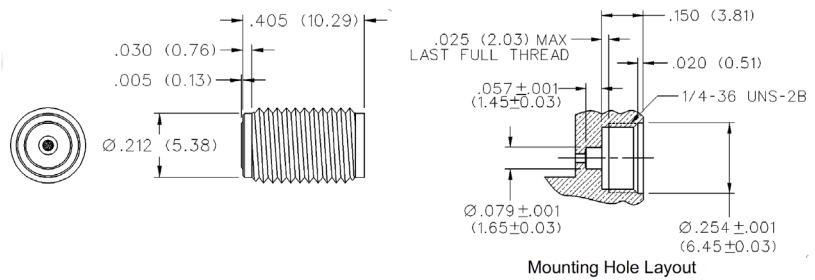

Hermetic Seal Feedthru

Part Number	Item 1 - Outer Ring	Item 2 - Insulator	Item 3 - Pin
142-1000-033	Kovar Gold pl 0.00005 minimum over Nickel pl 0.00005 minimum	Glass Corning 7070 or equivalent	Kovar Gold pl 0.00005 minimum over Nickel pl 0.00005 minimum

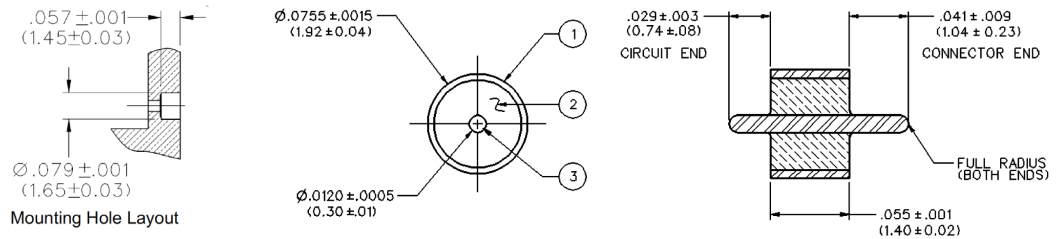

Notes:
1. Reference diagram on page 42

Product Specification Table

Environmental

Hermeticity	1x10 ⁻⁸ cc/sec at one atmosphere
Solderability	MIL-STD-202, Method 209 Operating
Temperature	-67°F to 329°F (-55°C to 165°C)

Electrical

Impedance	50 Ohms
Frequency Range	DC to 40GHz
VSWR	Dependent upon application
Working Voltage	250 VRMS maximum at sea level
Dielectric Withstanding	500 VRMS minimum at sea level
Insulation Resistance	5000 megohm minimum
Insertion Loss	0.2 dB maximum at 40GHz

- Notes:
1. The hermetic seal should be mounted as flush as possible with the housing. Excessive recession will create a high impedance air gap between connection and housing which degrades electrical performance.
 2. The use of an additional counterbore to accommodate a solder ring for seal mounting is not recommended. A slight chamfer may be used if care is taken to completely fill the area with solder - avoid air gaps.

Straight Solder Type Plug, with contact, slide-on nut

Part Number	Cable Type	Material
145-0693-001	0.086 Semi-Rigid (RG-405)	Stainless Steel/Gold Plated
145-0694-001	0.141 Semi-Rigid (RG-402)	Stainless Steel/Gold Plated
145-0693-002	0.086 Semi-Rigid (RG-405)	Stainless Steel/Passivated
145-0694-002	0.141 Semi-Rigid (RG-402)	Stainless Steel/Passivated

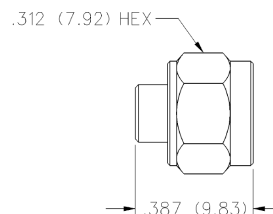
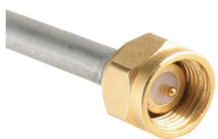

- Notes:
1. Stainless steel/passivated coupling nut & gold plated body
 2. Assembly instructions on page 41

Same Series Adapters

2.92mm adapters are offered in same series and between series configurations. They are precision manufactured to RF component industry specifications, with a maximum frequency of 40GHz.

Plug to Plug Same Series Adapter

Part Number	Material	Impedance	Maximum Frequency	VSWR
145-0901-811	Stainless Steel/Gold Plated	50 Ohms	40GHz	1.20

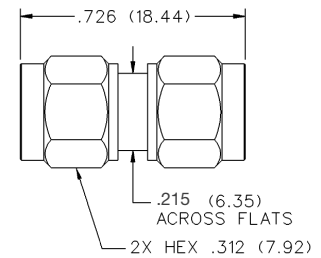

Plug to Jack Same Series Adapter

Part Number	Material	Impedance	Maximum Frequency	VSWR
145-0901-821	Stainless Steel/Gold Plated	50 Ohms	40GHz	1.20

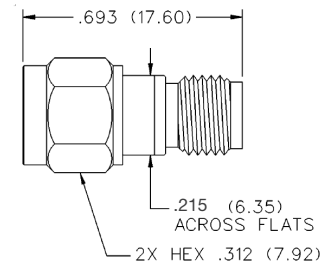

Jack to Jack Same Series Adapter

Part Number	Material	Impedance	Maximum Frequency	VSWR
145-0901-801	Stainless Steel/Gold Plated	50 Ohms	40GHz	1.20

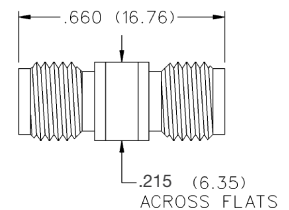

Between Series Adapters

Between Series, 2.92mm Jack To SMA Jack

Part Number	Material	Impedance	Maximum Frequency	VSWR
134-1010-000	Stainless Steel/Passivated	50 Ohms	26.5GHz	1.30

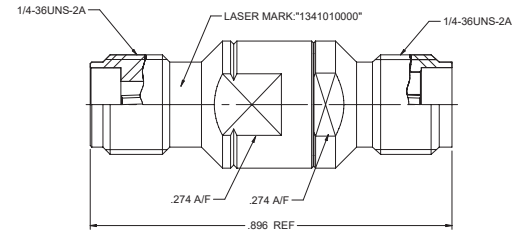

Between Series, 2.92mm Jack To SMA Plug

Part Number	Material	Impedance	Maximum Frequency	VSWR
134-1010-001	Stainless Steel/Passivated	50 Ohms	26.5GHz	1.30

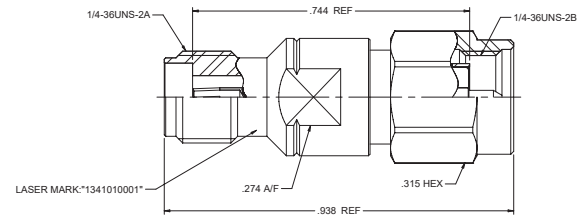

Between Series, 2.92mm Plug To SMA Jack

Part Number	Material	Impedance	Maximum Frequency	VSWR
134-1010-002	Stainless Steel/Passivated	50 Ohms	26.5GHz	1.30

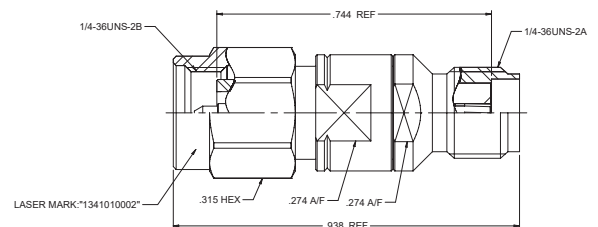

Between Series, 2.92mm Plug To SMA Plug

Part Number	Material	Impedance	Maximum Frequency	VSWR
134-1010-003	Stainless Steel/Passivated	50 Ohms	26.5GHz	1.30

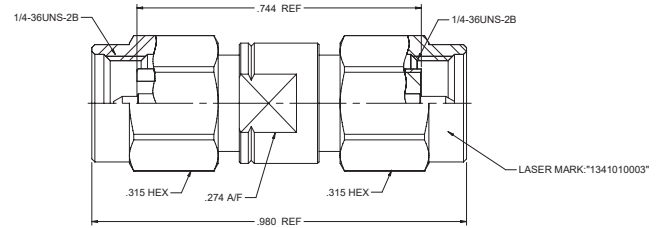

Between Series, 2.92mm Jack To SMP Female

Part Number	Material	Impedance	Maximum Frequency	VSWR
134-1000-000	Stainless Steel/Passivated	50 Ohms	40GHz	1.25

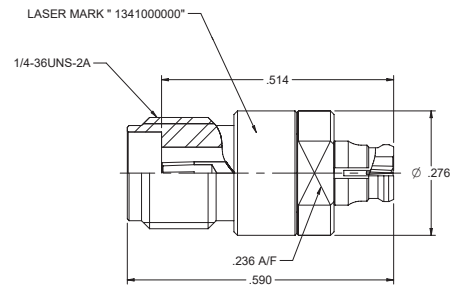

Between Series, 2.92mm Jack To SMP Male

Part Number	Material	Impedance	Maximum Frequency	VSWR
134-1000-001	Stainless Steel/Passivated	50 Ohms	40GHz	1.25

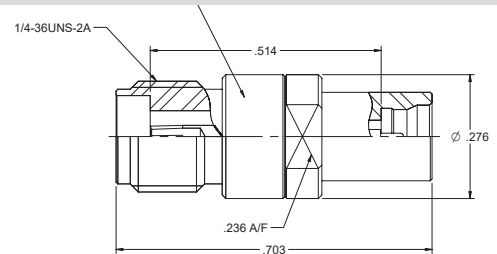

Between Series, 2.92mm Plug To SMP Female

Part Number	Material	Impedance	Maximum Frequency	VSWR
134-1000-002	Stainless Steel/Passivated	50 Ohms	40GHz	1.25

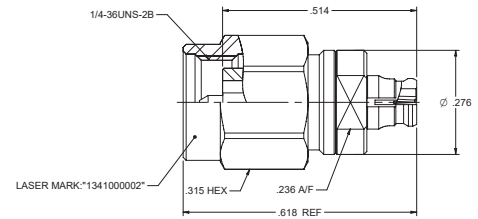
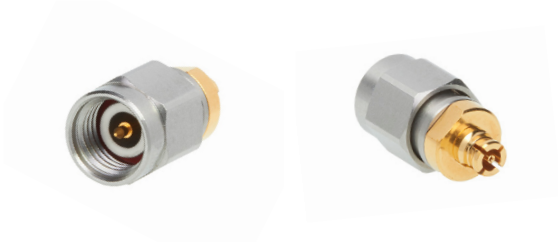

Between Series, 2.92mm Plug To SMP Male

Part Number	Material	Impedance	Maximum Frequency	VSWR
134-1000-003	Stainless Steel/Passivated	50 Ohms	40GHz	1.25

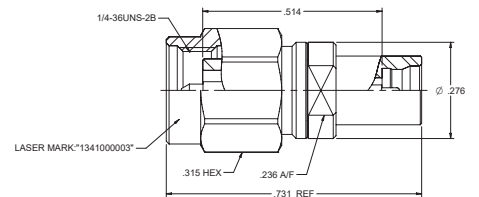
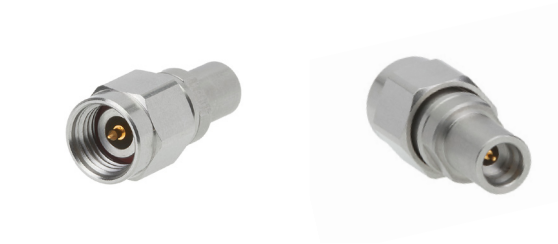

Between Series, 2.92mm Jack To SMP Female

Part Number	Material	Impedance	Maximum Frequency	VSWR
134-1000-004	Stainless Steel/Passivated	50 Ohms	40GHz	1.25

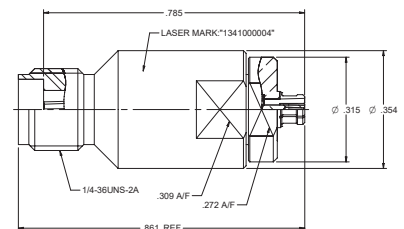
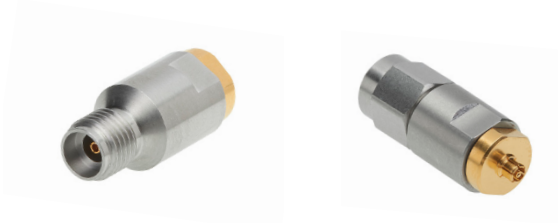

Between Series, 2.92mm Jack To SMPM Male

Part Number	Material	Impedance	Maximum Frequency	VSWR
134-1000-005	Stainless Steel/Passivated	50 Ohms	40GHz	1.25

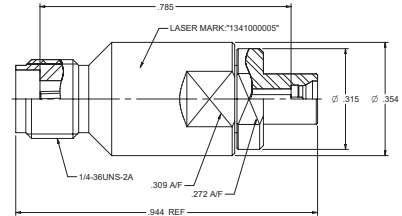

Between Series, 2.92mm Plug To SMPM Female

Part Number	Material	Impedance	Maximum Frequency	VSWR
134-1000-006	Stainless Steel/Passivated	50 Ohms	40GHz	1.25

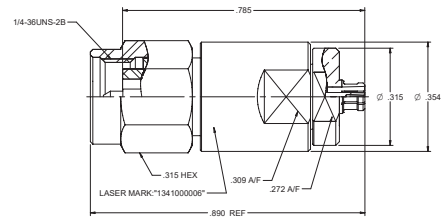
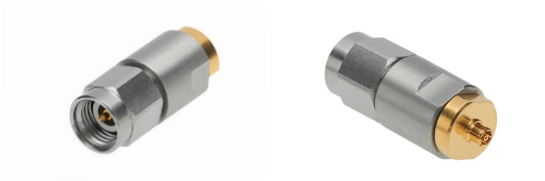

Between Series, 2.92mm Plug To SMPM Male

Part Number	Material	Impedance	Maximum Frequency	VSWR
134-1000-007	Stainless Steel/Passivated	50 Ohms	40GHz	1.25

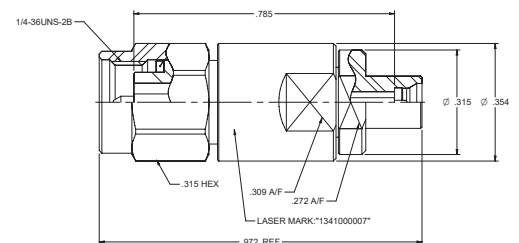

Terminations

Termination Jack

Part Number	Material	Impedance	Maximum Frequency	VSWR
145-0701-881	Stainless Steel/Passivated	50 Ohms	40GHz	1.30

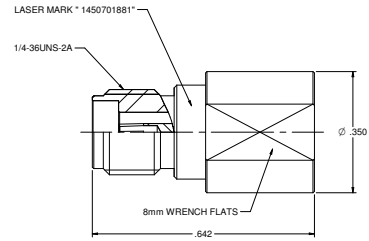

Termination Plug

Part Number	Material	Impedance	Maximum Frequency	VSWR
145-0701-881	Stainless Steel/Passivated	50 Ohms	40GHz	1.30

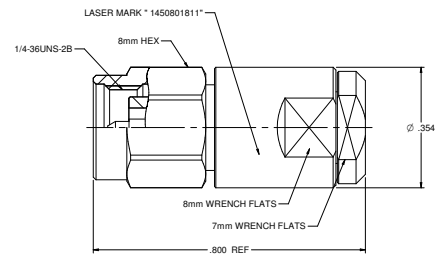

2.92mm Cabled Connectors

Accurate assembly of the 2.92mm cabled connectors is obtained with the tools listed below. Industry standard devices are used if possible for customer convenience and tool compatibility.

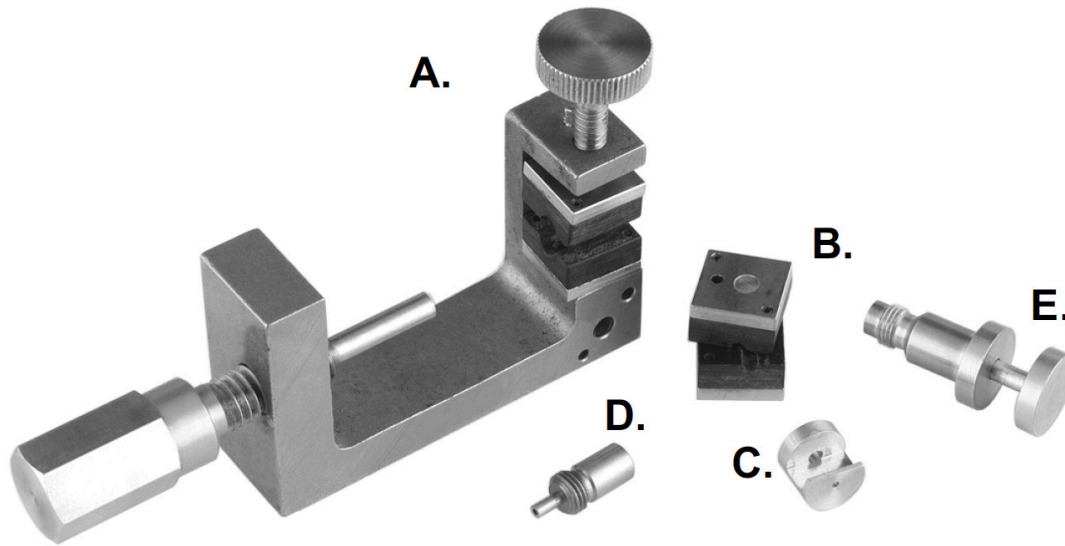

Item	Part Number	Description
A	140-0000-962	Semi-rigid cable vise (does not include inserts(B) or vise stop (F))
B	140-0000-964 140-0000-965	Cable clamp inserts, 0.086 semi-rigid Cable clamp inserts, 0.141 semi-rigid
C	140-0000-960 140-0000-961	Contact soldering tool, 0.086 plug Contact soldering tool, 0.141 plug
D	140-0000-958 140-0000-959	Body soldering tool, 0.086 plug Body soldering tool, 0.141 plug
E	140-0000-957	Bead assembly tool, Semi-rigid plugs, all cables
F	140-0000-968	Vise stop, (2.92mm)

2.92mm Solder Type Straight Plugs for Semi-Rigid Cables

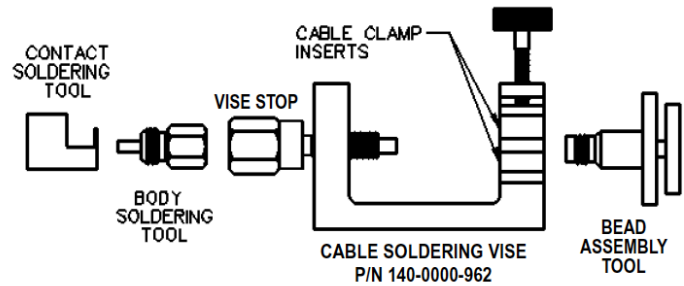
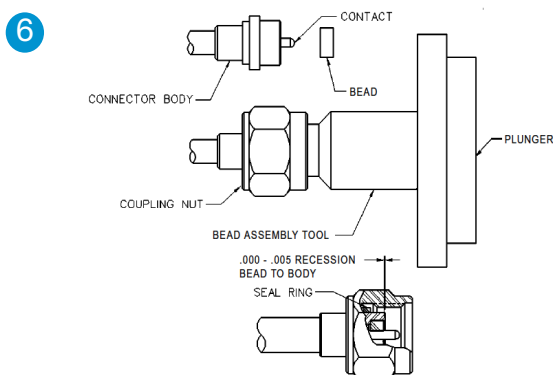
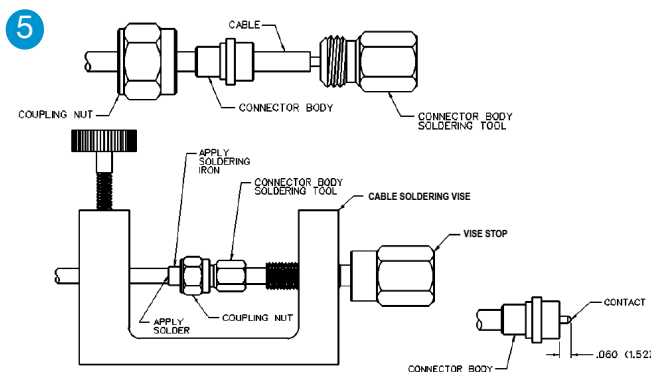
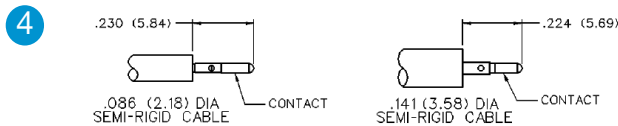
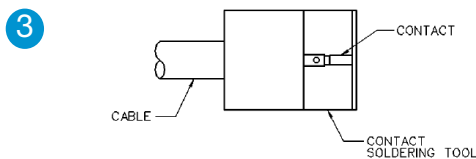
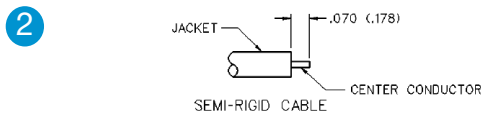
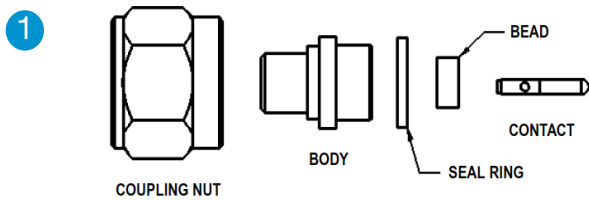

- 1 Identify connector parts (5 piece parts) and tools (5 tools.)
- 2 Strip cable jacket and dielectric to dimension shown.
- 3 Place center contact onto center conductor. Slide contact soldering tool onto contact. Clamp the cable contact and tool into cable soldering vise and solder contact to center conductor. High temperature solder, such as 95/5 Sn/Ag is recommended so that contact solder joint remains stable during body soldering operation. Solder paste is recommended for the contact solder joint to minimize excess solder. The assembled dimension should be as shown.
- 4 Remove excess solder from contact with a sharp blade and clean contact. Check for presence of excess solder by sliding body soldering tool over the contact. Remove soldering tool.
- 5 Place connector nut and body on cable. Place connector body soldering tool over contact and thread the coupling nut and connector body firmly to the tool. Place cable subassembly into cable soldering vise. Clamp cable and soldering tool securely to insure the cable dielectric expansion will not disturb the cable in the vise during soldering, Place hot soldering iron on the connector body sleeve and apply solder from the opposite side. A low temp solder, such as 60/40 Sn/Pb is recommended for the body solder joint. Allow the soldered joint to cool and remove from fixture. Check contact location to the body. The best electrical results are achieved when the contact location is within a tolerance of 0.060 +/- 0.001.
- 6 Place bead onto neck portion of the tool. Thread Bead Assembly tool firmly into the coupling nut. Push the tool's plunger between your thumb and fingers to assemble the bead. Check bead location. Assemble seal ring onto body.

Tool	145-0693-001/002 (for 0.086 semi-rigid)	145-0694-001/002 (for 0.141 semi-rigid)
Semi-Rigid Cable Vise	140-0000-962	140-0000-962
Vise Stop	140-0000-968	140-0000-968
Bead Assy. Tool	140-0000-957	140-0000-957
Contact Soldering Tool	140-0000-960	140-0000-961
Body Soldering Tool	140-0000-958	140-0000-959
Cable Clamp Insert	140-0000-964	140-0000-965

Field Replaceable

The field replaceable connectors manufactured by Johnson, are easy to install and replace. The hermetic seal is mounted into the circuit module wall and the connector can be removed and replaced without destroying the hermeticity of the circuit housing.

The field replaceable connector creates a transition from microstrip circuitry to a coaxial transmission line. The 2.92mm seal pin diameter is 0.012 (0.030) to minimize the capacitive effects on the circuit trace. For optimum electrical performance, the transition from the hermetic seal to the microstrip trace must be properly compensated. Compensation involves adjusting the microstrip trace width to minimize any impedance discontinuities found in the transition area.

The plot shown below is representative of the typical return loss of a Johnson field replaceable 2.92mm connector. To produce the data shown below, a test fixture is created using the Johnson 2.92mm hermetic seal. The fixture consists of a suitably thick spacer plate with the hermetic seal mounted flush to both surfaces. Two connectors are mounted back to back around the fixture and the VSWR of this test assembly is measured. The calculated return loss trace shown is equivalent to the square root of the measured VSWR of the test assembly. Since the connectors tested are of identical design, it can be stated with fair accuracy that the calculated data shown represents the response of a single field replaceable connector and its transition to the hermetic seal.

Although Johnson does not publish a VSWR specification for field replaceable connectors, typical connector return loss can be expected to be less than -20 dB through 40GHz. A VSWR specification is not stated because an industry standard method for testing field replaceable connectors does not exist. The actual performance of the connector is dependent upon the following:

1. For optimum electrical performance, Johnson recommends the use of our standard 142-1000-033 hermetic seal with a pin diameter of $0.0120 (0.305) \pm 0.0005 (0.013)$.
2. It is recommended that the hermetic seal be mounted flush with the circuit housing. Tolerance variations between the hermetic seal and machined housing do not always guarantee an optimum transition to the connector. Some manufacturers recommend an additional counterbore in the circuit housing to accommodate a solder washer during installation of the seal. Johnson does not recommend this type of installation because if the counterbore is not completely filled with solder, electrical discontinuities may be created.
3. The transition between the hermetic seal pin and the microstrip trace will effect electrical performance, as stated above. Several different methods of hermetic seal mounting and seal pin to microstrip trace attachment are used in the industry.

Field Replaceable Test Assembly

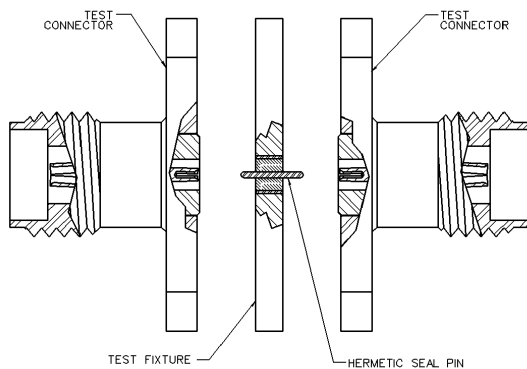

Typical Return Loss

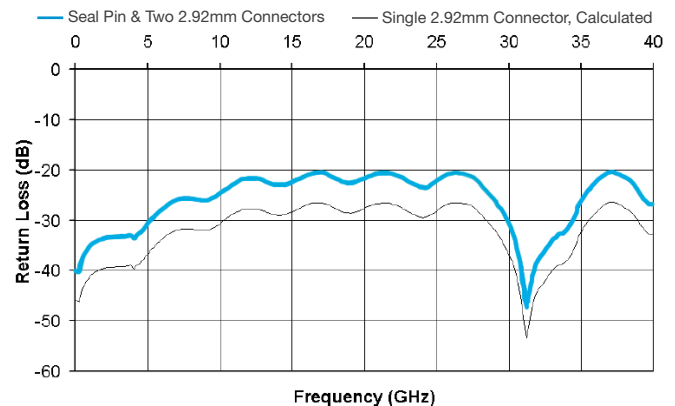

2.92mm (SMK) End Launch Connectors

PC Mounting Instructions (Screw-on Type)

Step A. Position the end launch connector on the pc board and make sure the connector body is fit tightly against the board edge.

Step B. Insert mounting screw # 1-72 through spring washer, mounting body, pc board and bottom base. Slightly adjust the location and make sure the contact pin is centered on the signal trace.

Step C. Tighten the screws and the torque force should not exceed 20 in-oz.

Optional:

Step D. Solder the contact pin on the signal trace by using a minimal amount of solder. Ensure the solder flows along with the length of the outside pin to create a good solder joint.

Step E. Remove any excess solder and clean all flux and other residues from the solder joint area. (Note: Any excess solder or flux will affect performance.)

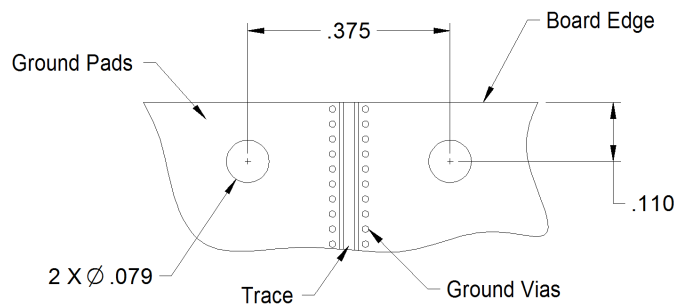
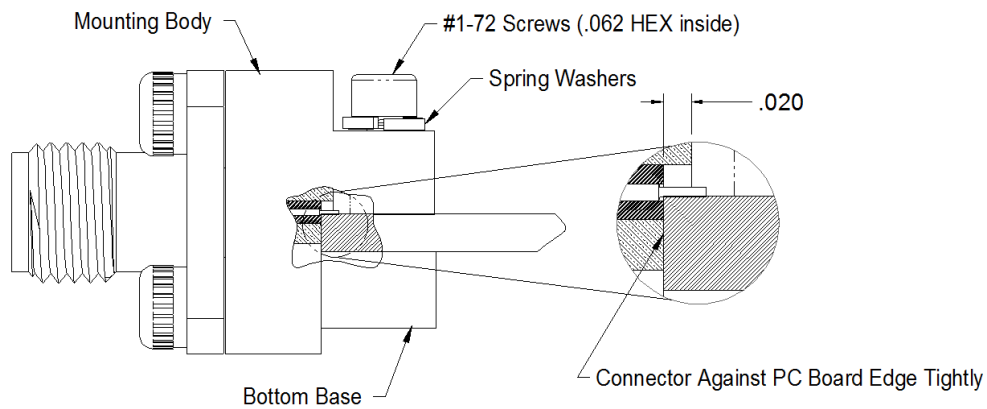
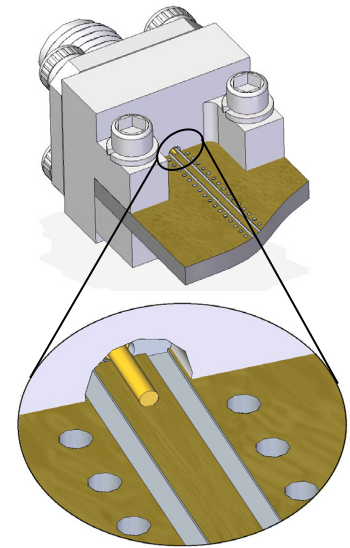

Test Data with Coplanar Waveguide Circuit Board

DUT information:

2.92mm End Launch Screw-on Type Jack (Connector P/N.145-0701-802)

Rogers RO3003 Circuit Board (0.010" Substrate Thickness, 1oz Copper Foil)

Signal Trace: Grounded Coplanar Waveguide (GCPW)

(Note: GCPW is the recommended transmission line structure on the circuit board for this connector, but other type trace line such as microstrip also can be used and resulted in good performance.)

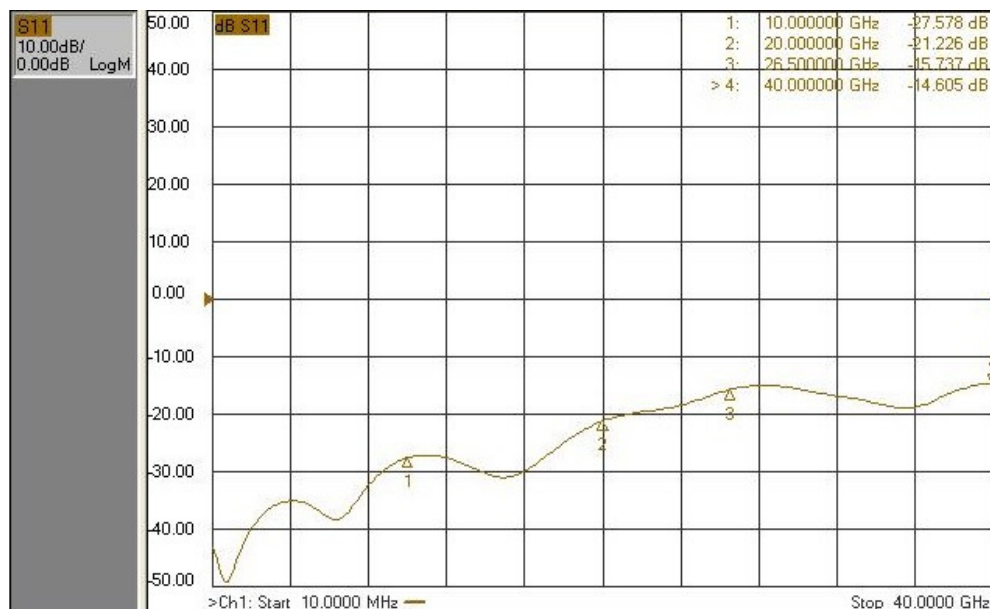
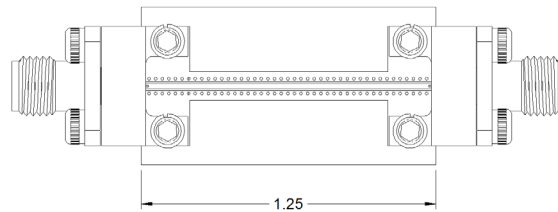
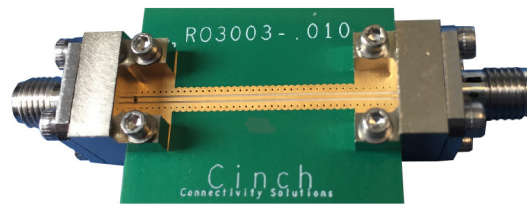



About Cinch Connectivity Solutions

For over 100 years, Cinch Connectivity Solutions has manufactured high-quality and reliable high-performance connectors and cable assemblies. Cinch is recognized as a world class connectivity supplier of RF, fiber optic, hybrid, microwave components, circular, d-subminiatures, modular rectangular, electronic enclosures and cable assemblies.

Cinch provides innovative solutions to the military, commercial aerospace, networking, telecommunication, test and measurement, oil and gas and other harsh environment industries.

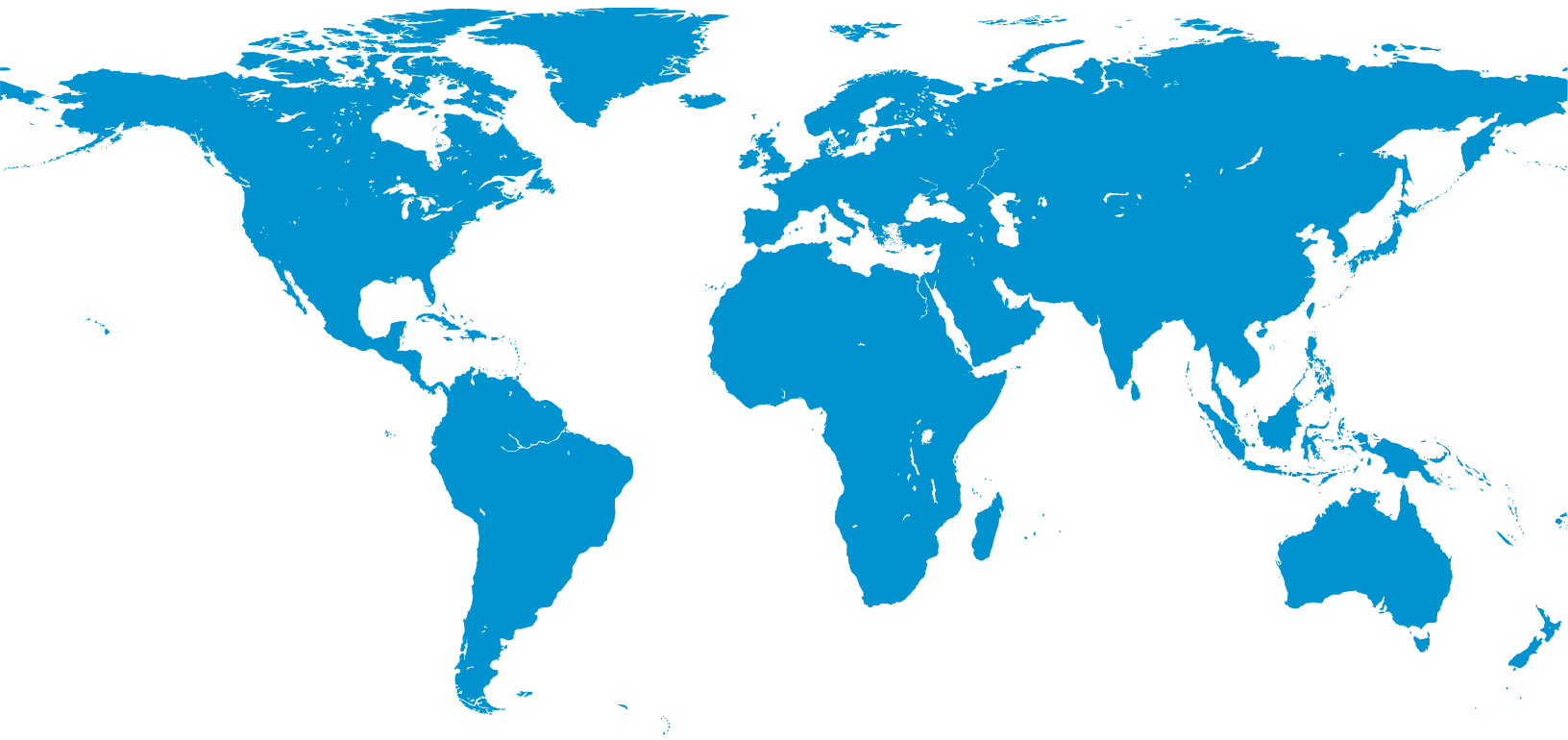

For more information, please contact us:

North America

+1 507.833.8822

ccsorders@us.cinch.com

Asia-Pacific

+86 21 5442 7668

ccs.asia.sales@as.cinch.com

Europe, Middle East

+44 (0) 1245 342060

CinchConnectivity@eu.cinch.com

belfuse.com/cinch.com

