

1. Features

- XRES pin to support in-system serial programming (ISSP) and external reset control in CY8C24894
- Powerful Harvard-architecture processor
 - M8C processor speeds up to 24 MHz
 - Two 8 × 8 multiply, 32-bit accumulate
 - Low power at high speed
 - Operating voltage: 3 V to 5.25 V
 - Industrial temperature range: -40 °C to +85 °C
 - USB temperature range: -10 °C to +85 °C
- Advanced peripherals (PSoC® Blocks)
 - Six rail-to-rail analog PSoC blocks provide:
 - Up to 14-bit analog-to-digital converters (ADCs)
 - Up to 9-bit digital-to-analog converters (DACs)
 - Programmable gain amplifiers (PGAs)
 - Programmable filters and comparators
 - Four digital PSoC blocks provide:
 - 8- to 32-bit timers, counters, and pulse width modulators (PWMs)
 - Cyclical redundancy check (CRC) and pseudo random sequence (PRS) modules
 - Full-duplex universal asynchronous receiver transmitter (UART)
 - Multiple serial peripheral interface (SPI) masters or slaves
 - Connectable to all general-purpose I/O (GPIO) pins
 - Complex peripherals by combining blocks
 - Capacitive sensing application (CSA) capability
- Full speed USB (12 Mbps)
 - Four unidirectional endpoints
 - One bidirectional control endpoint
 - USB 2.0 compliant
 - Dedicated 256 byte buffer
 - No external crystal required
- Flexible on-chip memory
 - 16 KB flash program storage 50,000 erase and write cycles
 - 1 KB static random access memory (SRAM) data storage
 - ISSP
 - Partial flash updates
 - Flexible protection modes
 - Electrically erasable programmable read-only memory (EEPROM) emulation in flash
- Programmable pin configurations
 - 25-mA sink, 10-mA source on all GPIOs
 - Pull-up, pull-down, high Z, strong, or open-drain drive modes on all GPIOs

- Up to 48 analog inputs on GPIOs
- Two 33 mA analog outputs on GPIOs
- Configurable interrupt on all GPIOs
- Precision, programmable clocking
 - Internal ±4% 24- / 48-MHz main oscillator
 - Internal oscillator for watchdog and sleep
 - 0.25% accuracy for USB with no external components
- Additional system resources
 - I²C slave, master, and multi-master to 400 kHz
 - Watchdog and sleep timers
 - User-configurable low-voltage detection (LVD)

2. Logic Block Diagram

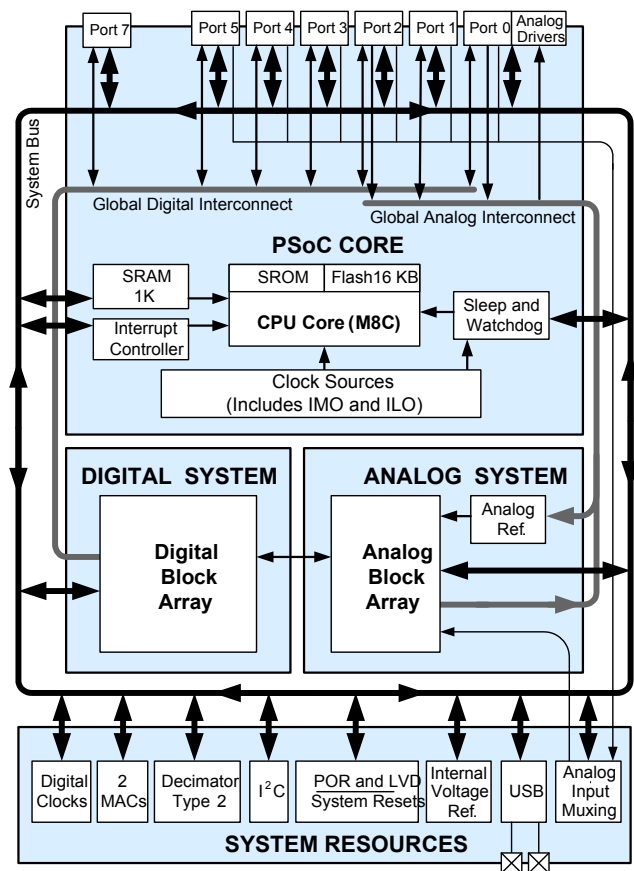

Errata: For information on silicon errata, see "Errata" on page 66. Details include trigger conditions, devices affected, and proposed workaround.

3. More Information

Cypress provides a wealth of data at www.cypress.com to help you to select the right PSoC device for your design, and to help you to quickly and effectively integrate the device into your design. For a comprehensive list of resources, see the knowledge base article [KBA92181, Resources Available for CapSense® Controllers](#). Following is an abbreviated list for CapSense devices:

- Overview: [CapSense Portfolio](#), [CapSense Roadmap](#)
 - Product Selectors: [CapSense](#), [CapSense Plus](#), [CapSense Express](#), [PSoC3 with CapSense](#), [PSoC5 with CapSense](#), [PSoC4](#). In addition, [PSoC Designer](#) offers a device selection tool at the time of creating a new project.
 - Application notes: Cypress offers CapSense application notes covering a broad range of topics, from basic to advanced level. Recommended application notes for getting started with CapSense are:
 - [AN64846: Getting Started With CapSense](#)
 - [AN2397: CapSense® Data Viewing Tools](#)
 - Technical Reference Manual (TRM):
 - [CY8CPLC20](#), [CY8CLEDD16P01](#), [CY8C29x66](#), [CY8C27x43](#), [CY8C24x94](#), [CY8C24x23](#), [CY8C24x23A](#), [CY8C22x13](#), [CY8C21x34](#), [CY8C21x34B](#), [CY8C21x23](#), [CY7C64215](#), [CY7C603xx](#), [CY8CNP1xx](#), and [CYWUSB6953 PSoC® Programmable System-on-Chip TRM](#)
 - Development Kits:
 - [CY3280-24x94 Universal CapSense Controller Board](#) features a predefined control circuitry and plug-in hardware to make prototyping and debugging easy. Programming and I2C-to-USB Bridge hardware are included for tuning and data acquisition.
 - [CY3280-BMM Matrix Button Module Kit](#) consists of eight CapSense sensors organized in a 4x4 matrix format to form 16 physical buttons and eight LEDs. This module connects to any CY3280 Universal CapSense Controller Board, including CY3280-20x66 Universal CapSense Controller.
 - [CY3280-BSM Simple Button Module Kit](#) consists of ten CapSense buttons and ten LEDs. This module connects to any CY3280 Universal CapSense Controller Board, including CY3280-20x66 Universal CapSense Controller.
- The [CY3217-MiniProg1](#) and [CY8CKIT-002 PSoC® MiniProg3](#) device provides an interface for flash programming.

3.1 PSoC Designer

[PSoC Designer](#) is a free Windows-based Integrated Design Environment (IDE). It enables concurrent hardware and firmware design of systems based on CapSense (see [Figure 1](#)). With PSoC Designer, you can:

1. Drag and drop User Modules to build your hardware system design in the main design workspace
2. Codesign your application firmware with the PSoC hardware, using the PSoC Designer IDE C compiler
3. Configure User Module
4. Explore the library of user modules
5. Review user module datasheets

Figure 1. PSoC Designer Features

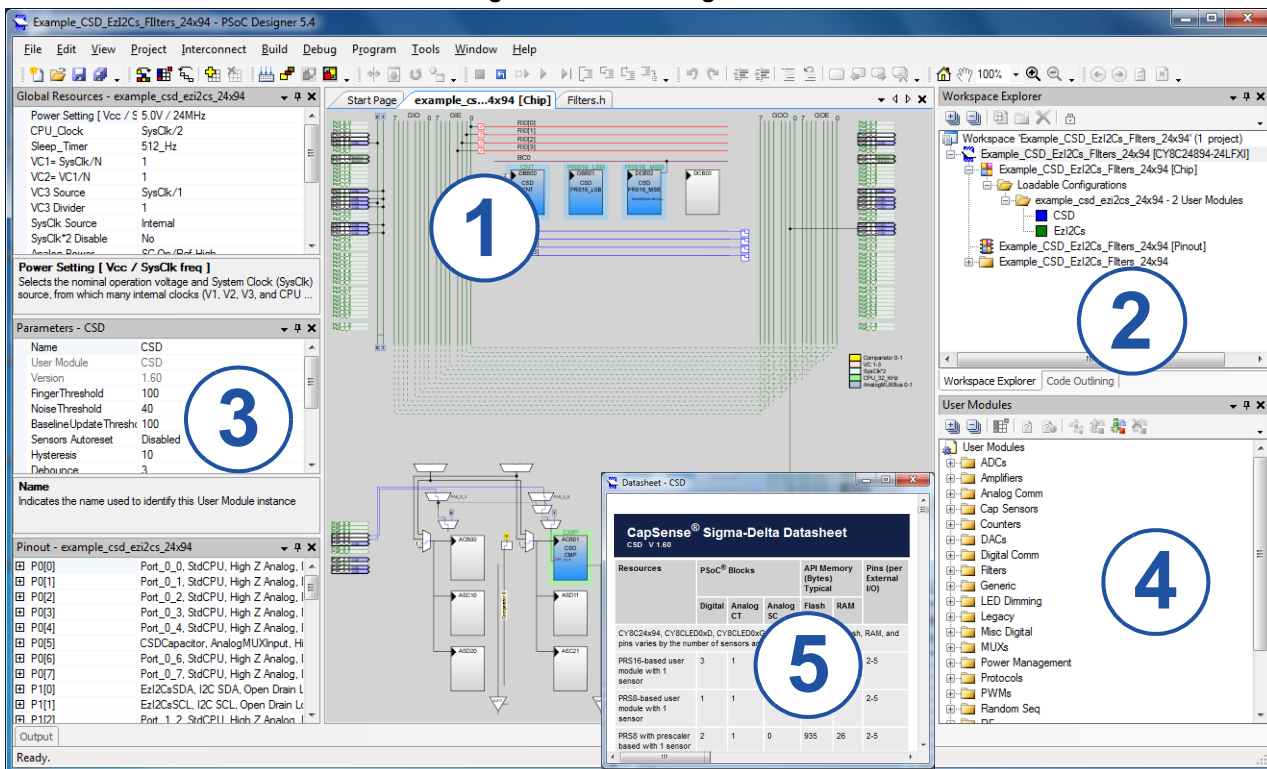

4. Contents

PSOC FUNCTIONAL OVERVIEW	4
The PSoC Core	4
The Digital System	4
The Analog System	5
Additional System Resources	6
PSoC Device Characteristics	6
GETTING STARTED	7
Application Notes	7
Development Kits	7
Training	7
CYPros Consultants	7
Solutions Library	7
Technical Support	7
DEVELOPMENT TOOLS	7
PSoC Designer Software Subsystems	7
DESIGNING WITH PSOC DESIGNER	8
Select User Modules	8
Configure User Modules	8
Organize and Connect	8
Generate, Verify, and Debug	8
PIN INFORMATION	9
56-Pin Part Pinout	9
56-Pin Part Pinout (with XRES)	10
68-Pin Part Pinout	11
68-Pin Part Pinout (On-Chip Debug)	12
100-Ball VFBGA Part Pinout	13
100-Ball VFBGA Part Pinout (On-Chip Debug)	15
100-Pin Part Pinout (On-Chip Debug)	17
REGISTER REFERENCE	19
Register Conventions	19
Register Mapping Tables	19
Register Map Bank 0 Table: User Space	20
Register Map Bank 1 Table: Configuration Space	21
ELECTRICAL SPECIFICATIONS	22
Absolute Maximum Ratings	22
Operating Temperature	23
DC Electrical Characteristics	23
AC Electrical Characteristics	37
Thermal Impedance	45
Solder Reflow Peak Specifications	45
DEVELOPMENT TOOL SELECTION	46
Software	46
Development Kits	46
Evaluation Tools	46

Device Programmers	46
Accessories (Emulation and Programming)	47
ORDERING INFORMATION	48
Ordering Code Definitions	48
PACKAGING DIMENSIONS	49
ACRONYMS	54
Acronyms Used	54
DOCUMENT CONVENTIONS	55
Units of Measure	55
Numeric Conventions	55
GLOSSARY	55
ERRATA	60
Part Numbers Affected	60
CY8C24x94 Errata Summary	60
DOCUMENT HISTORY PAGE	64
SALES, SOLUTIONS, AND LEGAL INFORMATION	67
Worldwide Sales and Design Support	67
Products	67
PSoC® Solutions	67
Cypress Developer Community	67
Technical Support	67

5. PSoC Functional Overview

The PSoC family consists of many devices with on-chip controllers. These devices are designed to replace multiple traditional MCU-based system components with one low-cost single-chip programmable component. A PSoC device includes configurable blocks of analog and digital logic, and programmable interconnect. This architecture makes it possible for you to create customized peripheral configurations, to match the requirements of each individual application. Additionally, a fast central processing unit (CPU), flash program memory, SRAM data memory, and configurable I/O are included in a range of convenient pinouts.

The PSoC architecture, shown in “Logic Block Diagram” on page 1, consists of four main areas: the core, the system resources, the digital system, and the analog system. Configurable global bus resources allow combining all of the device resources into a complete custom system. Each CY8C24x94 PSoC device includes four digital blocks and six analog blocks. Depending on the PSoC package, up to 56 GPIOs are also included. The GPIOs provide access to the global digital and analog interconnects.

5.1 The PSoC Core

The PSoC core is a powerful engine that supports a rich instruction set. It encompasses SRAM for data storage, an interrupt controller, sleep and watchdog timers, and internal main oscillator (IMO) and internal low-speed oscillator (ILO). The CPU core, called the M8C, is a powerful processor with speeds up to 24 MHz. The M8C is a four-million instructions per second (MIPS) 8-bit Harvard-architecture microprocessor.

System resources provide these additional capabilities:

- Digital clocks for increased flexibility
- I²C functionality to implement an I²C master and slave
- An internal voltage reference, multi-master, that provides an absolute value of 1.3 V to a number of PSoC subsystems
- A switch-mode pump (SMP) that generates normal operating voltages from a single battery cell
- Various system resets supported by the M8C

The digital system consists of an array of digital PSoC blocks that may be configured into any number of digital peripherals. The digital blocks are connected to the GPIOs through a series of global buses. These buses can route any signal to any pin, freeing designs from the constraints of a fixed peripheral controller.

The analog system consists of six analog PSoC blocks, supporting comparators, and analog-to-digital conversion up to 10-bits of precision.

5.2 The Digital System

The digital system consists of four digital PSoC blocks. Each block is an 8-bit resource that is used alone or combined with other blocks to form 8-, 16-, 24-, and 32-bit peripherals, which are called user modules. Digital peripheral configurations include:

- PWMs (8- to 32-bit)
- PWMs with dead band (8- to 32-bit)
- Counters (8- to 32-bit)
- Timers (8- to 32-bit)
- UART 8-bit with selectable parity
- SPI master and slave
- I²C slave and multi-master
- CRC/generator (8-bit)
- IrDA
- PRS generators (8- to 32-bit)

The digital blocks are connected to any GPIO through a series of global buses that can route any signal to any pin. The buses also allow for signal multiplexing and for performing logic operations. This configurability frees your designs from the constraints of a fixed peripheral controller.

Digital blocks are provided in rows of four, where the number of blocks varies by PSoC device family. This allows the optimum choice of system resources for your application. Family resources are shown in Table 1 on page 7.

Figure 2. Digital System Block Diagram

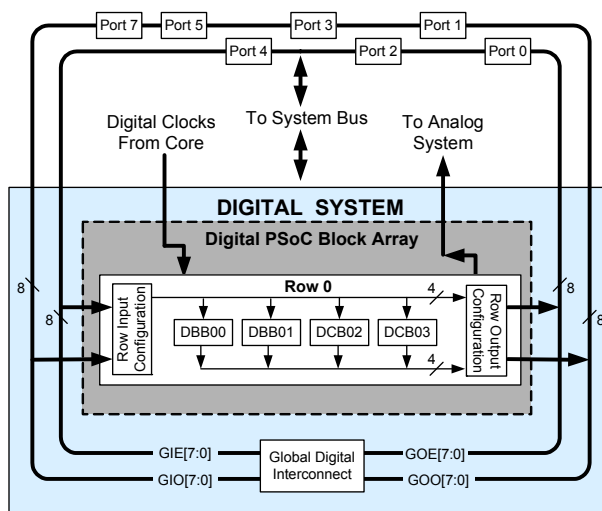

5.3 The Analog System

The analog system is composed of six configurable blocks, each comprised of an opamp circuit allowing the creation of complex analog signal flows. Analog peripherals are very flexible and can be customized to support specific application requirements. Some of the more common PSoC analog functions (most available as user modules) are as follows.

- ADCs (up to two, with 6- to 14-bit resolution, selectable as incremental, delta sigma, and successive approximation register (SAR))
- Filters (2 and 4 pole band-pass, low-pass, and notch)
- Amplifiers (up to two, with selectable gain to 48x)
- Instrumentation amplifiers (one with selectable gain to 93x)
- Comparators (up to two, with 16 selectable thresholds)
- DACs (up to two, with 6- to 9-bit resolution)
- Multiplying DACs (up to two, with 6- to 9-bit resolution)
- High current output drivers (two with 30 mA drive as a PSoC core resource)
- 1.3-V reference (as a system resource)
- DTMF dialer
- Modulators
- Correlators
- Peak detectors
- Many other topologies possible

Analog blocks are arranged in a column of three, which includes one continuous time (CT) and two switched capacitor (SC) blocks, as shown in Figure 3.

Figure 3. Analog System Block Diagram

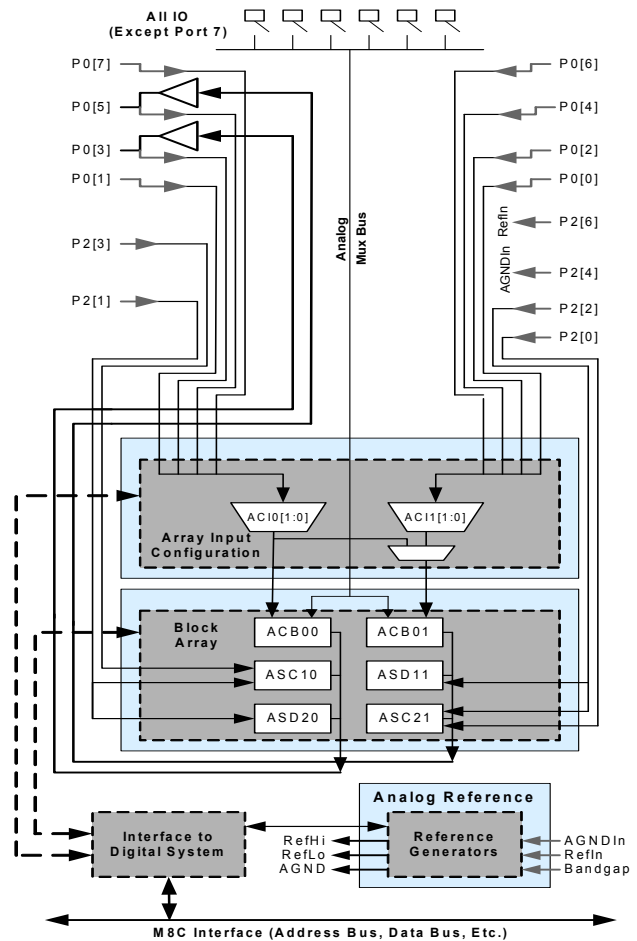

5.3.1 The Analog Multiplexer System

The analog mux bus can connect to every GPIO pin in ports 0–5. Pins are connected to the bus individually or in any combination. The bus also connects to the analog system for analysis with comparators and analog-to-digital converters. It is split into two sections for simultaneous dual-channel processing. An additional 8:1 analog input multiplexer provides a second path to bring Port 0 pins to the analog array.

Switch-control logic enables selected pins to precharge continuously under hardware control. This enables capacitive measurement for applications such as touch sensing. Other multiplexer applications include:

- Track pad, finger sensing
- Chip-wide mux that enables analog input from up to 48 I/O pins
- Crosspoint connection between any I/O pin combinations

5.4 Additional System Resources

System resources provide additional capability useful to complete systems. Additional resources include a multiplier, decimator, low-voltage detection, and power-on reset (POR). Brief statements describing the merits of each resource follow.

- Full speed USB (12 Mbps) with five configurable endpoints and 256 bytes of RAM. No external components required except for two series resistors. Wider than commercial temperature USB operation (–10 °C to +85 °C).
- Digital clock dividers provide three customizable clock frequencies for use in applications. The clocks can be routed to both the digital and analog systems. Additional clocks are generated using digital PSoC blocks as clock dividers.
- Two multiply accumulates (MACs) provide fast 8-bit multipliers with 32-bit accumulate, to assist in both general math and digital filters.
- Decimator provides a custom hardware filter for digital signal processing applications including creation of Delta Sigma ADCs.
- The I²C module provides 100- and 400-kHz communication over two wires. Slave, master, multi-master are supported.
- Low-voltage detection interrupts signal the application of falling voltage levels, while the advanced POR circuit eliminates the need for a system supervisor.
- An internal 1.3-V reference provides an absolute reference for the analog system, including ADCs and DACs.
- Versatile analog multiplexer system.

5.5 PSoC Device Characteristics

Depending on your PSoC device characteristics, the digital and analog systems can have 16, 8, or 4 digital blocks and 12, 6, or 4 analog blocks. The following table lists the resources available for specific PSoC device groups. The device covered by this datasheet is shown in the highlighted row of the table.

Table 1. PSoC Device Characteristics

PSoC Part Number	Digital I/O	Digital Rows	Digital Blocks	Analog Inputs	Analog Outputs	Analog Columns	Analog Blocks	SRAM Size	Flash Size
CY8C29x66	up to 64	4	16	up to 12	4	4	12	2 K	32 K
CY8C28xxx	up to 44	up to 3	up to 12	up to 44	up to 4	up to 6	up to 12 + 4 ^[1]	1 K	16 K
CY8C27x43	up to 44	2	8	up to 12	4	4	12	256	16 K
CY8C24x94	up to 56	1	4	up to 48	2	2	6	1 K	16 K
CY8C24x23A	up to 24	1	4	up to 12	2	2	6	256	4 K
CY8C23x33	up to 26	1	4	up to 12	2	2	4	256	8 K
CY8C22x45	up to 38	2	8	up to 38	0	4	6 ^[1]	1 K	16 K
CY8C21x45	up to 24	1	4	up to 24	0	4	6 ^[1]	512	8 K
CY8C21x34	up to 28	1	4	up to 28	0	2	4 ^[1]	512	8 K
CY8C21x23	up to 16	1	4	up to 8	0	2	4 ^[1]	256	4 K
CY8C20x34	up to 28	0	0	up to 28	0	0	3 ^[1,2]	512	8 K
CY8C20xx6	up to 36	0	0	up to 36	0	0	3 ^[1,2]	up to 2 K	up to 32 K

Notes

1. Limited analog functionality.
2. Two analog blocks and one CapSense®.

6. Getting Started

For in-depth information, along with detailed programming information, see the [Technical Reference Manual](#) for this PSoC device.

For up-to-date ordering, packaging, and electrical specification information, see the latest PSoC device datasheets on the web at <http://www.cypress.com>.

6.1 Application Notes

[Cypress application notes](#) are an excellent introduction to the wide variety of possible PSoC designs.

6.2 Development Kits

[PSoC Development Kits](#) are available online from and through a growing number of regional and global distributors, which include Arrow, Avnet, Digi-Key, Farnell, Future Electronics, and Newark.

6.3 Training

[Free PSoC technical training](#) (on demand, webinars, and workshops), which is available online via www.cypress.com,

7. Development Tools

PSoC Designer™ is the revolutionary Integrated Design Environment (IDE) that you can use to customize PSoC to meet your specific application requirements. PSoC Designer software accelerates system design and time to market. Develop your applications using a library of precharacterized analog and digital peripherals (called user modules) in a drag-and-drop design environment. Then, customize your design by leveraging the dynamically generated application programming interface (API) libraries of code. Finally, debug and test your designs with the integrated debug environment, including in-circuit emulation and standard software debug features. PSoC Designer includes:

- Application editor graphical user interface (GUI) for device and user module configuration and dynamic reconfiguration
- Extensive user module catalog
- Integrated source-code editor (C and assembly)
- Free C compiler with no size restrictions or time limits
- Built-in debugger
- In-circuit emulation
- Built-in support for communication interfaces:
 - Hardware and software I²C slaves and masters
 - Full speed USB 2.0
 - Up to four full-duplex universal asynchronous receiver/transmitters (UARTs), SPI master and slave, and wireless

PSoC Designer supports the entire library of PSoC 1 devices and runs on Windows XP, Windows Vista, and Windows 7.

7.1 PSoC Designer Software Subsystems

7.1.1 Design Entry

In the chip-level view, choose a base device to work with. Then select different onboard analog and digital components that use

covers a wide variety of topics and skill levels to assist you in your designs.

6.4 CYPros Consultants

Certified PSoC consultants offer everything from technical assistance to completed PSoC designs. To contact or become a PSoC consultant go to the [CYPros Consultants](#) web site.

6.5 Solutions Library

Visit our growing [library of solution-focused designs](#). Here you can find various application designs that include firmware and hardware design files that enable you to complete your designs quickly.

6.6 Technical Support

[Technical support](#) – including a searchable Knowledge Base articles and technical forums – is also available online. If you cannot find an answer to your question, call our Technical Support hotline at 1-800-541-4736.

the PSoC blocks, which are called user modules. Examples of user modules are analog-to-digital converters (ADCs), digital-to-analog converters (DACs), amplifiers, and filters. Configure the user modules for your chosen application and connect them to each other and to the proper pins. Then generate your project. This prepopulates your project with APIs and libraries that you can use to program your application.

The tool also supports easy development of multiple configurations and dynamic reconfiguration. Dynamic reconfiguration makes it possible to change configurations at run time. In essence, this allows you to use more than 100 percent of PSoC's resources for an application.

7.1.2 Code Generation Tools

The code generation tools work seamlessly within the PSoC Designer interface and have been tested with a full range of debugging tools. You can develop your design in C, assembly, or a combination of the two.

Assemblers. The assemblers allow you to merge assembly code seamlessly with C code. Link libraries automatically use absolute addressing or are compiled in relative mode, and are linked with other software modules to get absolute addressing.

C Language Compilers. C language compilers are available that support the PSoC family of devices. The products allow you to create complete C programs for the PSoC family devices. The optimizing C compilers provide all of the features of C, tailored to the PSoC architecture. They come complete with embedded libraries providing port and bus operations, standard keypad and display support, and extended math functionality.

7.1.3 Debugger

PSoC Designer has a debug environment that provides hardware in-circuit emulation, allowing you to test the program in a physical system while providing an internal view of the PSoC device. Debugger commands allow you to read and program and

read and write data memory, and read and write I/O registers. You can read and write CPU registers, set and clear breakpoints, and provide program run, halt, and step control. The debugger also allows you to create a trace buffer of registers and memory locations of interest.

7.1.4 Online Help System

The online help system displays online, context-sensitive help. Designed for procedural and quick reference, each functional subsystem has its own context-sensitive help. This system also provides tutorials and links to FAQs and an online support forum to aid the designer.

8. Designing with PSoC Designer

The development process for the PSoC[®] device differs from that of a traditional fixed function microprocessor. The configurable analog and digital hardware blocks give the PSoC architecture a unique flexibility that pays dividends in managing specification change during development and by lowering inventory costs. These configurable resources, called PSoC Blocks, have the ability to implement a wide variety of user-selectable functions. The PSoC development process is summarized in four steps:

1. Select [User Modules](#)
2. Configure User Modules
3. Organize and Connect
4. Generate, Verify, and Debug

8.1 Select User Modules

PSoC Designer provides a library of prebuilt, pretested hardware peripheral components called “user modules.” User modules make selecting and implementing peripheral devices, both analog and digital, simple.

8.2 Configure User Modules

Each user module that you select establishes the basic register settings that implement the selected function. They also provide parameters and properties that allow you to tailor their precise configuration to your particular application. For example, a PWM User Module configures one or more digital PSoC blocks, one for each 8 bits of resolution. The user module parameters permit you to establish the pulse width and duty cycle. Configure the parameters and properties to correspond to your chosen application. Enter values directly or by selecting values from drop-down menus. All the user modules are documented in datasheets that may be viewed directly in PSoC Designer or on the Cypress website. These [user module datasheets](#) explain the internal operation of the user module and provide performance specifications. Each datasheet describes the use of each user module parameter, and other information you may need to successfully implement your design.

7.1.5 In-Circuit Emulator

A low-cost, high-functionality In-Circuit Emulator (ICE) is available for development support. This hardware can program single devices.

The emulator consists of a base unit that connects to the PC using a USB port. The base unit is universal and operates with all PSoC devices. Emulation pods for each device family are available separately. The emulation pod takes the place of the PSoC device in the target board and performs full speed (24-MHz) operation.

8.3 Organize and Connect

You build signal chains at the chip level by interconnecting user modules to each other and the I/O pins. You perform the selection, configuration, and routing so that you have complete control over all on-chip resources.

8.4 Generate, Verify, and Debug

When you are ready to test the hardware configuration or move on to developing code for the project, you perform the “Generate Configuration Files” step. This causes PSoC Designer to generate source code that automatically configures the device to your specification and provides the software for the system. The generated code provides application programming interfaces (APIs) with high-level functions to control and respond to hardware events at run time and interrupt service routines that you can adapt as needed.

A complete code development environment allows you to develop and customize your applications in either C, assembly language, or both.

The last step in the development process takes place inside PSoC Designer’s debugger (access by clicking the Connect icon). PSoC Designer downloads the HEX image to the ICE where it runs at full speed. PSoC Designer debugging capabilities rival those of systems costing many times more. In addition to traditional single-step, run-to-breakpoint, and watch-variable features, the debug interface provides a large trace buffer and allows you to define complex breakpoint events. These include monitoring address and data bus values, memory locations and external signals.

9.2 56-Pin Part Pinout (with XRES)

Table 3. 56-Pin Part Pinout (QFN^[6])

Pin No.	Type		Name	Description
	Digital	Analog		
1	I/O	I, M	P2[3]	Direct switched capacitor block input
2	I/O	I, M	P2[1]	Direct switched capacitor block input
3	I/O	M	P4[7]	
4	I/O	M	P4[5]	
5	I/O	M	P4[3]	
6	I/O	M	P4[1]	
7	I/O	M	P3[7]	
8	I/O	M	P3[5]	
9	I/O	M	P3[3]	
10	I/O	M	P3[1]	
11	I/O	M	P5[7]	
12	I/O	M	P5[5]	
13	I/O	M	P5[3]	
14	I/O	M	P5[1]	
15	I/O	M	P1[7]	I ² C SCL
16	I/O	M	P1[5]	I ² C SDA
17	I/O	M	P1[3]	
18	I/O	M	P1[1]	I ² C SCL, ISSP SCLK ^[7]
19	Power		V _{SS}	Ground connection ^[8]
20	USB		D+	
21	USB		D-	
22	Power		V _{DD}	Supply voltage
23	I/O		P7[7]	
24	I/O		P7[0]	
25	I/O	M	P1[0]	I ² C SDA, ISSP SDA ^[7]
26	I/O	M	P1[2]	
27	I/O	M	P1[4]	Optional EXTCLK
28	I/O	M	P1[6]	
29	I/O	M	P5[0]	
30	I/O	M	P5[2]	
31	I/O	M	P5[4]	
32	I/O	M	P5[6]	
33	I/O	M	P3[0]	
34	I/O	M	P3[2]	
35	I/O	M	P3[4]	
36	Input		XRES	Active high external reset with internal pull-down
37	I/O	M	P4[0]	
38	I/O	M	P4[2]	
39	I/O	M	P4[4]	
40	I/O	M	P4[6]	
41	I/O	I, M	P2[0]	Direct switched capacitor block input
42	I/O	I, M	P2[2]	Direct switched capacitor block input
43	I/O	M	P2[4]	External AGND input
Pin No.	Type		Name	Description
	Digital	Analog		
44	I/O	M	P2[6]	External VREF input
45	I/O	I, M	P0[0]	Analog column mux input
46	I/O	I, M	P0[2]	Analog column mux input
47	I/O	I, M	P0[4]	Analog column mux input VREF
48	I/O	I, M	P0[6]	Analog column mux input
49	Power		V _{DD}	Supply voltage
50	Power		V _{SS}	Ground connection ^[8]
51	I/O	I, M	P0[7]	Analog column mux input
52	I/O	I/O, M	P0[5]	Analog column mux input and column output
53	I/O	I/O, M	P0[3]	Analog column mux input and column output
54	I/O	I, M	P0[1]	Analog column mux input
55	I/O	M	P2[7]	
56	I/O	M	P2[5]	

LEGEND A = Analog, I = Input, O = Output, and M = Analog Mux Input.

Figure 5. CY8C24894 56-Pin PSoC Device

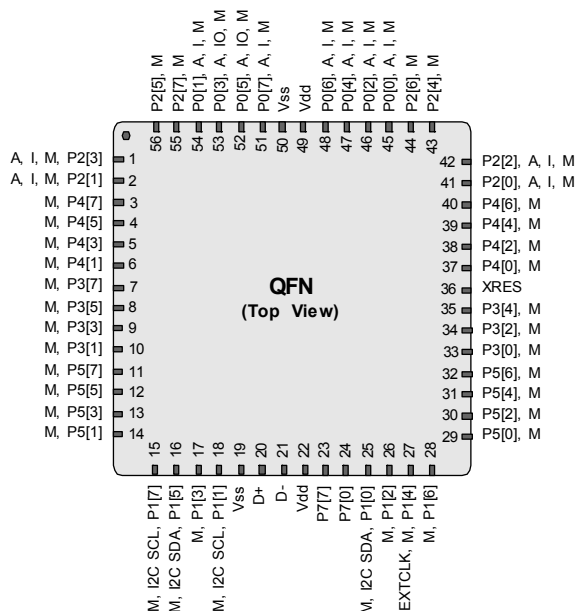

Notes

- The center pad on the QFN package should be connected to ground (V_{SS}) for best mechanical, thermal, and electrical performance. If not connected to ground, it should be electrically floated and not connected to any other signal.
- These are the ISSP pins, which are not High Z at POR. See the [PSoC Technical Reference Manual](#) for details.
- All V_{SS} pins should be brought out to one common GND plane.

9.3 68-Pin Part Pinout

The following 68-pin QFN part table and drawing is for the CY8C24994 PSoC device.

Table 4. 68-Pin Part Pinout (QFN^[9])

Pin No.	Type		Name	Description
	Digital	Analog		
1	I/O	M	P4[7]	
2	I/O	M	P4[5]	
3	I/O	M	P4[3]	
4	I/O	M	P4[1]	
5			NC	No connection. Pin must be left floating
6			NC	No connection. Pin must be left floating
7	Power		V _{SS}	Ground connection ^[10]
8	I/O	M	P3[7]	
9	I/O	M	P3[5]	
10	I/O	M	P3[3]	
11	I/O	M	P3[1]	
12	I/O	M	P5[7]	
13	I/O	M	P5[5]	
14	I/O	M	P5[3]	
15	I/O	M	P5[1]	
16	I/O	M	P1[7]	I ² C SCL
17	I/O	M	P1[5]	I ² C SDA
18	I/O	M	P1[3]	
19	I/O	M	P1[1]	I ² C SCL ISSP SCLK ^[11]
20	Power		V _{SS}	Ground connection ^[10]
21	USB		D+	
22	USB		D-	
23	Power		V _{DD}	Supply voltage
24	I/O		P7[7]	
25	I/O		P7[6]	
26	I/O		P7[5]	
27	I/O		P7[4]	
28	I/O		P7[3]	
29	I/O		P7[2]	
30	I/O		P7[1]	
31	I/O		P7[0]	
32	I/O	M	P1[0]	I ² C SDA, ISSP SDATA ^[11]
33	I/O	M	P1[2]	
34	I/O	M	P1[4]	Optional EXTCLK
35	I/O	M	P1[6]	
36	I/O	M	P5[0]	
37	I/O	M	P5[2]	
38	I/O	M	P5[4]	
39	I/O	M	P5[6]	
40	I/O	M	P3[0]	
41	I/O	M	P3[2]	
42	I/O	M	P3[4]	
43	I/O	M	P3[6]	
44			NC	No connection. Pin must be left floating.
45			NC	No connection. Pin must be left floating.
46	Input		XRES	Active high pin reset with internal pull-down.
47	I/O	M	P4[0]	
48	I/O	M	P4[2]	
49	I/O	M	P4[4]	

Figure 6. CY8C24994 68-Pin PSoC Device

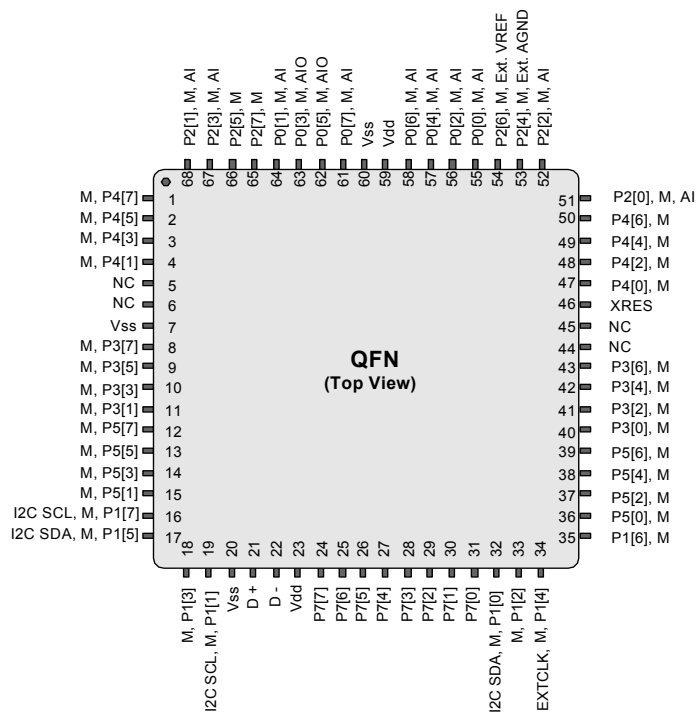

Pin No.	Type		Name	Description
	Digital	Analog		
50	I/O	M	P4[6]	
51	I/O	I, M	P2[0]	Direct switched capacitor block input
52	I/O	I, M	P2[2]	Direct switched capacitor block input
53	I/O	M	P2[4]	External AGND input
54	I/O	M	P2[6]	External VREF input
55	I/O	I, M	P0[0]	Analog column mux input
56	I/O	I, M	P0[2]	Analog column mux input and column output
57	I/O	I, M	P0[4]	Analog column mux input and column output
58	I/O	I, M	P0[6]	Analog column mux input
59	Power		V _{DD}	Supply voltage
60	Power		V _{SS}	Ground connection ^[10]
61	I/O	I, M	P0[7]	Analog column mux input, integration input #1
62	I/O	I/O, M	P0[5]	Analog column mux input and column output, integration input #2
63	I/O	I/O, M	P0[3]	Analog column mux input and column output
64	I/O	I, M	P0[1]	Analog column mux input
65	I/O	M	P2[7]	
66	I/O	M	P2[5]	
67	I/O	I, M	P2[3]	Direct switched capacitor block input
68	I/O	I, M	P2[1]	Direct switched capacitor block input

LEGEND A = Analog, I = Input, O = Output, NC = No connection. Pin must be left floating, M = Analog Mux Input.

Notes

- The center pad on the QFN package should be connected to ground (V_{SS}) for best mechanical, thermal, and electrical performance. If not connected to ground, it should be electrically floated and not connected to any other signal.
- All V_{SS} pins should be brought out to one common GND plane.
- These are the ISSP pins, which are not High Z at POR. See the [PSoC Technical Reference Manual](#) for details.

9.4 68-Pin Part Pinout (On-Chip Debug)

The following 68-pin QFN part table and drawing is for the CY8C24094 OCD PSoC device.

Note This part is only used for in-circuit debugging. It is NOT available for production.

Table 5. 68-Pin Part Pinout (QFN^[12])

Pin No.	Type		Name	Description
	Digital	Analog		
1	I/O	M	P4[7]	
2	I/O	M	P4[5]	
3	I/O	M	P4[3]	
4	I/O	M	P4[1]	
5			OCDE	OCD even data I/O
6			OCDO	OCD odd data output
7	Power		V _{SS}	Ground connection ^[13]
8	I/O	M	P3[7]	
9	I/O	M	P3[5]	
10	I/O	M	P3[3]	
11	I/O	M	P3[1]	
12	I/O	M	P5[7]	
13	I/O	M	P5[5]	
14	I/O	M	P5[3]	
15	I/O	M	P5[1]	
16	I/O	M	P1[7]	I ² C SCL
17	I/O	M	P1[5]	I ² C SDA
18	I/O	M	P1[3]	
19	I/O	M	P1[1]	I ² C SCL, ISSP SCLK ^[14]
20	Power		V _{SS}	Ground connection ^[13]
21	USB		D+	
22	USB		D-	
23	Power		V _{DD}	Supply voltage
24	I/O		P7[7]	
25	I/O		P7[6]	
26	I/O		P7[5]	
27	I/O		P7[4]	
28	I/O		P7[3]	
29	I/O		P7[2]	
30	I/O		P7[1]	
31	I/O		P7[0]	
32	I/O	M	P1[0]	I ² C SDA, ISSP SCLK ^[14]
33	I/O	M	P1[2]	
34	I/O	M	P1[4]	Optional EXTCLK
35	I/O	M	P1[6]	
36	I/O	M	P5[0]	
37	I/O	M	P5[2]	
38	I/O	M	P5[4]	
39	I/O	M	P5[6]	
40	I/O	M	P3[0]	
41	I/O	M	P3[2]	
42	I/O	M	P3[4]	
43	I/O	M	P3[6]	
44			HCLK	OCD high speed clock output
45			CCLK	OCD CPU clock output
46	Input		XRES	Active high pin reset with internal pull-down
47	I/O	M	P4[0]	
48	I/O	M	P4[2]	
49	I/O	M	P4[4]	

Figure 7. CY8C24094 68-Pin OCD PSoC Device

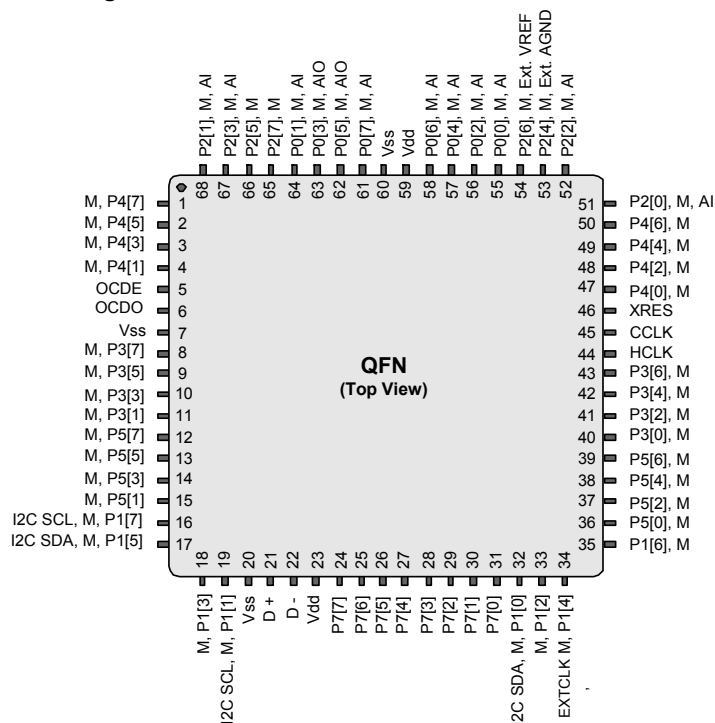

Pin No.	Type		Name	Description
	Digital	Analog		
50	I/O	M	P4[6]	
51	I/O	I, M	P2[0]	Direct switched capacitor block input
52	I/O	I, M	P2[2]	Direct switched capacitor block input
53	I/O	M	P2[4]	External AGND input
54	I/O	M	P2[6]	External VREF input
55	I/O	I, M	P0[0]	Analog column mux input
56	I/O	I, M	P0[2]	Analog column mux input and column output
57	I/O	I, M	P0[4]	Analog column mux input and column output
58	I/O	I, M	P0[6]	Analog column mux input
59	Power		V _{DD}	Supply voltage
60	Power		V _{SS}	Ground connection ^[13]
61	I/O	I, M	P0[7]	Analog column mux input, integration input #1
62	I/O	I/O, M	P0[5]	Analog column mux input and column output, integration input #2
63	I/O	I/O, M	P0[3]	Analog column mux input and column output
64	I/O	I, M	P0[1]	Analog column mux input
65	I/O	M	P2[7]	
66	I/O	M	P2[5]	
67	I/O	I, M	P2[3]	Direct switched capacitor block input
68	I/O	I, M	P2[1]	Direct switched capacitor block input

LEGEND A = Analog, I = Input, O = Output, M = Analog Mux Input, OCD = On-Chip Debugger.

Notes

- 12. The center pad on the QFN package should be connected to ground (V_{SS}) for best mechanical, thermal, and electrical performance. If not connected to ground, it should be electrically floated and not connected to any other signal.
- 13. All V_{SS} pins should be brought out to one common GND plane.
- 14. These are the ISSP pins, which are not High Z at POR. See the [PSoC Technical Reference Manual](#) for details.

9.5 100-Ball VFBGA Part Pinout

The 100-ball VFBGA part is for the CY8C24994 PSoC device.

Table 6. 100-Ball Part Pinout (VFBGA^[15])

Pin No.	Digital	Analog	Name	Description	Pin No.	Digital	Analog	Name	Description
A1	Power		V _{SS}	Ground connection	F1			NC	No connection. Pin must be left floating
A2	Power		V _{SS}	Ground connection	F2	I/O	M	P5[7]	
A3			NC	No connection. Pin must be left floating	F3	I/O	M	P3[5]	
A4			NC	No connection. Pin must be left floating	F4	I/O	M	P5[1]	
A5			NC	No connection. Pin must be left floating	F5	Power		V _{SS}	Ground connection
A6	Power		V _{DD}	Supply voltage	F6	Power		V _{SS}	Ground connection
A7			NC	No connection. Pin must be left floating	F7	I/O	M	P5[0]	
A8			NC	No connection. Pin must be left floating	F8	I/O	M	P3[0]	
A9	Power		V _{SS}	Ground connection	F9			XRES	Active high pin reset with internal pull-down
A10	Power		V _{SS}	Ground connection	F10	I/O		P7[1]	
B1	Power		V _{SS}	Ground connection	G1			NC	No connection. Pin must be left floating
B2	Power		V _{SS}	Ground connection	G2	I/O	M	P5[5]	
B3	I/O	I, M	P2[1]	Direct switched capacitor block input	G3	I/O	M	P3[3]	
B4	I/O	I, M	P0[1]	Analog column mux input	G4	I/O	M	P1[7]	I ² C SCL
B5	I/O	I, M	P0[7]	Analog column mux input	G5	I/O	M	P1[1]	I ² C SCL, ISSP SCLK ^[16]
B6	Power		V _{DD}	Supply voltage	G6	I/O	M	P1[0]	I ² C SDA, ISSP SDATA ^[16]
B7	I/O	I, M	P0[2]	Analog column mux input	G7	I/O	M	P1[6]	
B8	I/O	I, M	P2[2]	Direct switched capacitor block input	G8	I/O	M	P3[4]	
B9	Power		V _{SS}	Ground connection	G9	I/O	M	P5[6]	
B10	Power		V _{SS}	Ground connection	G10	I/O		P7[2]	
C1			NC	No connection. Pin must be left floating	H1			NC	No connection. Pin must be left floating
C2	I/O	M	P4[1]		H2	I/O	M	P5[3]	
C3	I/O	M	P4[7]		H3	I/O	M	P3[1]	
C4	I/O	M	P2[7]		H4	I/O	M	P1[5]	I ² C SDA
C5	I/O	I/O, M	P0[5]	Analog column mux input and column output	H5	I/O	M	P1[3]	
C6	I/O	I, M	P0[6]	Analog column mux input	H6	I/O	M	P1[2]	
C7	I/O	I, M	P0[0]	Analog column mux input	H7	I/O	M	P1[4]	Optional EXTCLK
C8	I/O	I, M	P2[0]	Direct switched capacitor block input	H8	I/O	M	P3[2]	
C9	I/O	M	P4[2]		H9	I/O	M	P5[4]	
C10			NC	No connection. Pin must be left floating	H10	I/O		P7[3]	
D1			NC	No connection. Pin must be left floating	J1	Power		V _{SS}	Ground connection
D2	I/O	M	P3[7]		J2	Power		V _{SS}	Ground connection
D3	I/O	M	P4[5]		J3	USB		D+	
D4	I/O	M	P2[5]		J4	USB		D-	
D5	I/O	I/O, M	P0[3]	Analog column mux input and column output	J5	Power		V _{DD}	Supply voltage
D6	I/O	I, M	P0[4]	Analog column mux input	J6	I/O		P7[7]	
D7	I/O	M	P2[6]	External VREF input	J7	I/O		P7[0]	
D8	I/O	M	P4[6]		J8	I/O	M	P5[2]	
D9	I/O	M	P4[0]		J9	Power		V _{SS}	Ground connection
D10			NC	No connection. Pin must be left floating	J10	Power		V _{SS}	Ground connection
E1			NC	No connection. Pin must be left floating	K1	Power		V _{SS}	Ground connection
E2			NC	No connection. Pin must be left floating	K2	Power		V _{SS}	Ground connection
E3	I/O	M	P4[3]		K3			NC	No connection. Pin must be left floating
E4	I/O	I, M	P2[3]	Direct switched capacitor block input	K4			NC	No connection. Pin must be left floating
E5	Power		V _{SS}	Ground connection	K5	Power		V _{DD}	Supply voltage
E6	Power		V _{SS}	Ground connection	K6	I/O		P7[6]	
E7	I/O	M	P2[4]	External AGND input	K7	I/O		P7[5]	
E8	I/O	M	P4[4]		K8	I/O		P7[4]	
E9	I/O	M	P3[6]		K9	Power		V _{SS}	Ground connection
E10			NC	No connection. Pin must be left floating	K10	Power		V _{SS}	Ground connection

LEGEND A = Analog, I = Input, O = Output, M = Analog Mux Input, NC = No connection. Pin must be left floating.

Figure 8. CY8C24094 OCD (Not for Production)

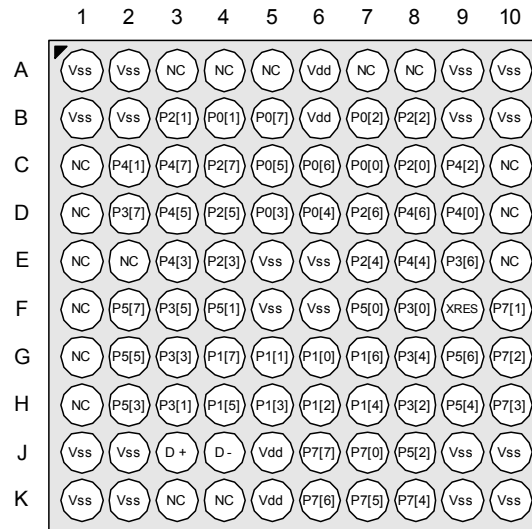

BGA (Top View)

Notes

- 15. All V_{SS} pins should be brought out to one common GND plane.
- 16. These are the ISSP pins, which are not High Z at POR. See the [PSoC Technical Reference Manual](#) for details.

9.6 100-Ball VFBGA Part Pinout (On-Chip Debug)

The following 100-pin VFBGA part table and drawing is for the CY8C24094 OCD PSoC device.

Note This part is only used for in-circuit debugging. It is NOT available for production.

Table 7. 100-Ball Part Pinout (VFBGA^[17])

Pin No.	Digital	Analog	Name	Description	Pin No.	Digital	Analog	Name	Description
A1	Power		V _{SS}	Ground connection	F1			OCDE	OCD even data I/O
A2	Power		V _{SS}	Ground connection	F2	I/O	M	P5[7]	
A3			NC	No connection. Pin must be left floating	F3	I/O	M	P3[5]	
A4			NC	No connection. Pin must be left floating	F4	I/O	M	P5[1]	
A5			NC	No connection. Pin must be left floating.	F5	Power		V _{SS}	Ground connection
A6	Power		V _{DD}	Supply voltage.	F6	Power		V _{SS}	Ground connection
A7			NC	No connection. Pin must be left floating.	F7	I/O	M	P5[0]	
A8			NC	No connection. Pin must be left floating.	F8	I/O	M	P3[0]	
A9	Power		V _{SS}	Ground connection	F9			XRES	Active high pin reset with internal pull-down
A10	Power		V _{SS}	Ground connection	F10	I/O		P7[1]	
B1	Power		V _{SS}	Ground connection	G1			OCDO	OCD odd data output
B2	Power		V _{SS}	Ground connection	G2	I/O	M	P5[5]	
B3	I/O	I, M	P2[1]	Direct switched capacitor block input	G3	I/O	M	P3[3]	
B4	I/O	I, M	P0[1]	Analog column mux input	G4	I/O	M	P1[7]	I ² C SCL
B5	I/O	I, M	P0[7]	Analog column mux input	G5	I/O	M	P1[1]	I ² C SCL, ISSP SCLK ^[18]
B6	Power		V _{DD}	Supply voltage	G6	I/O	M	P1[0]	I ² C SDA, ISSP SDATA ^[18]
B7	I/O	I, M	P0[2]	Analog column mux input	G7	I/O	M	P1[6]	
B8	I/O	I, M	P2[2]	Direct switched capacitor block input	G8	I/O	M	P3[4]	
B9	Power		V _{SS}	Ground connection	G9	I/O	M	P5[6]	
B10	Power		V _{SS}	Ground connection	G10	I/O		P7[2]	
C1			NC	No connection. Pin must be left floating	H1			NC	No connection. Pin must be left floating
C2	I/O	M	P4[1]		H2	I/O	M	P5[3]	
C3	I/O	M	P4[7]		H3	I/O	M	P3[1]	
C4	I/O	M	P2[7]		H4	I/O	M	P1[5]	I ² C SDA
C5	I/O	I/O, M	P0[5]	Analog column mux input and column output	H5	I/O	M	P1[3]	
C6	I/O	I, M	P0[6]	Analog column mux input	H6	I/O	M	P1[2]	
C7	I/O	I, M	P0[0]	Analog column mux input	H7	I/O	M	P1[4]	Optional EXTCLK
C8	I/O	I, M	P2[0]	Direct switched capacitor block input	H8	I/O	M	P3[2]	
C9	I/O	M	P4[2]		H9	I/O	M	P5[4]	
C10			NC	No connection. Pin must be left floating	H10	I/O		P7[3]	
D1			NC	No connection. Pin must be left floating	J1	Power		V _{SS}	Ground connection
D2	I/O	M	P3[7]		J2	Power		V _{SS}	Ground connection
D3	I/O	M	P4[5]		J3	USB		D+	
D4	I/O	M	P2[5]		J4	USB		D-	
D5	I/O	I/O, M	P0[3]	Analog column mux input and column output	J5	Power		V _{DD}	Supply voltage
D6	I/O	I, M	P0[4]	Analog column mux input	J6	I/O		P7[7]	
D7	I/O	M	P2[6]	External VREF input	J7	I/O		P7[0]	
D8	I/O	M	P4[6]		J8	I/O	M	P5[2]	
D9	I/O	M	P4[0]		J9	Power		V _{SS}	Ground connection
D10			CCCLK	OCD CPU clock output	J10	Power		V _{SS}	Ground connection
E1			NC	No connection. Pin must be left floating	K1	Power		V _{SS}	Ground connection
E2			NC	No connection. Pin must be left floating	K2	Power		V _{SS}	Ground connection
E3	I/O	M	P4[3]		K3			NC	No connection. Pin must be left floating
E4	I/O	I, M	P2[3]	Direct switched capacitor block input	K4			NC	No connection. Pin must be left floating
E5	Power		V _{SS}	Ground connection	K5	Power		V _{DD}	Supply voltage
E6	Power		V _{SS}	Ground connection	K6	I/O		P7[6]	
E7	I/O	M	P2[4]	External AGND input	K7	I/O		P7[5]	
E8	I/O	M	P4[4]		K8	I/O		P7[4]	
E9	I/O	M	P3[6]		K9	Power		V _{SS}	Ground connection
E10			HCLK	OCD high speed clock output	K10	Power		V _{SS}	Ground connection

LEGEND A = Analog, I = Input, O = Output, M = Analog Mux Input, NC = No connection. Pin must be left floating, OCD = On-Chip Debugger.

Notes

17. All V_{SS} pins should be brought out to one common GND plane.

18. These are the ISSP pins, which are not High Z at POR. See the [PSoC Technical Reference Manual](#) for details.

Figure 9. CY8C24094 OCD (Not for Production)

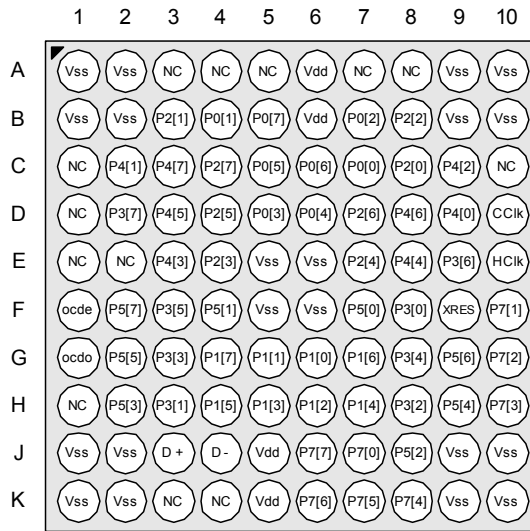

BGA (Top View)

9.7 100-Pin Part Pinout (On-Chip Debug)

The 100-pin TQFP part is for the CY8C24094 OCD PSoC device.

Note This part is only used for in-circuit debugging. It is NOT available for production.

Table 8. 100-Pin Part Pinout (TQFP^[19])

Pin No.	Digital	Analog	Name	Description	Pin No.	Digital	Analog	Name	Description
1			NC	No connection. Pin must be left floating	51	I/O	M	P1[6]	
2			NC	No connection. Pin must be left floating	52	I/O	M	P5[0]	
3	I/O	I, M	P0[1]	Analog column mux input	53	I/O	M	P5[2]	
4	I/O	M	P2[7]		54	I/O	M	P5[4]	
5	I/O	M	P2[5]		55	I/O	M	P5[6]	
6	I/O	I, M	P2[3]	Direct switched capacitor block input	56	I/O	M	P3[0]	
7	I/O	I, M	P2[1]	Direct switched capacitor block input	57	I/O	M	P3[2]	
8	I/O	M	P4[7]		58	I/O	M	P3[4]	
9	I/O	M	P4[5]		59	I/O	M	P3[6]	
10	I/O	M	P4[3]		60			HCLK	OCD high speed clock output
11	I/O	M	P4[1]		61			CCLK	OCD CPU clock output
12			OCDE	OCD even data I/O	62	Input		XRES	Active high pin reset with internal pull-down
13			OCDO	OCD odd data output	63	I/O	M	P4[0]	
14			NC	No connection. Pin must be left floating	64	I/O	M	P4[2]	
15	Power		V _{SS}	Ground connection	65	Power		V _{SS}	Ground connection
16	I/O	M	P3[7]		66	I/O	M	P4[4]	
17	I/O	M	P3[5]		67	I/O	M	P4[6]	
18	I/O	M	P3[3]		68	I/O	I, M	P2[0]	Direct switched capacitor block input
19	I/O	M	P3[1]		69	I/O	I, M	P2[2]	Direct switched capacitor block input
20	I/O	M	P5[7]		70	I/O		P2[4]	External AGND input
21	I/O	M	P5[5]		71			NC	No connection. Pin must be left floating
22	I/O	M	P5[3]		72	I/O		P2[6]	External VREF input
23	I/O	M	P5[1]		73			NC	No connection. Pin must be left floating
24	I/O	M	P1[7]	I ² C SCL	74	I/O	I	P0[0]	Analog column mux input
25			NC	No connection. Pin must be left floating	75			NC	No connection. Pin must be left floating
26			NC	No connection. Pin must be left floating	76			NC	No connection. Pin must be left floating
27			NC	No connection. Pin must be left floating	77	I/O	I, M	P0[2]	Analog column mux input and column output
28	I/O		P1[5]	I ² C SDA	78			NC	No connection. Pin must be left floating
29	I/O		P1[3]		79	I/O	I, M	P0[4]	Analog column mux input and column output
30	I/O		P1[1]	Crystal (XTALin), I ² C SCL, ISSP SCLK ^[20]	80			NC	No connection. Pin must be left floating
31			NC	No connection. Pin must be left floating	81	I/O	I, M	P0[6]	Analog column mux input
32	Power		V _{SS}	Ground connection	82	Power		V _{DD}	Supply voltage
33	USB		D+		83			NC	No connection. Pin must be left floating
34	USB		D-		84	Power		V _{SS}	Ground connection
35	Power		V _{DD}	Supply voltage	85			NC	No connection. Pin must be left floating
36	I/O		P7[7]		86			NC	No connection. Pin must be left floating
37	I/O		P7[6]		87			NC	No connection. Pin must be left floating
38	I/O		P7[5]		88			NC	No connection. Pin must be left floating
39	I/O		P7[4]		89			NC	No connection. Pin must be left floating
40	I/O		P7[3]		90			NC	No connection. Pin must be left floating
41	I/O		P7[2]		91			NC	No connection. Pin must be left floating
42	I/O		P7[1]		92			NC	No connection. Pin must be left floating
43	I/O		P7[0]		93			NC	No connection. Pin must be left floating
44			NC	No connection. Pin must be left floating	94			NC	No connection. Pin must be left floating
45			NC	No connection. Pin must be left floating	95	I/O	I, M	P0[7]	Analog column mux input
46			NC	No connection. Pin must be left floating	96			NC	No connection. Pin must be left floating
47			NC	No connection. Pin must be left floating	97	I/O	I/O, M	P0[5]	Analog column mux input and column output
48	I/O		P1[0]	Crystal (XTALout), I ² C SDA, ISSP SDATA ^[20]	98			NC	No connection. Pin must be left floating
49	I/O		P1[2]		99	I/O	I/O, M	P0[3]	Analog column mux input and column output
50	I/O		P1[4]	Optional EXTCLK	100			NC	No connection. Pin must be left floating

LEGEND A = Analog, I = Input, O = Output, NC = No connection. Pin must be left floating, M = Analog Mux Input, OCD = On-Chip Debugger.

Notes

19. All V_{SS} pins should be brought out to one common GND plane.

20. These are the ISSP pins, which are not High Z at POR. See the [PSoC Technical Reference Manual](#) for details.

Figure 10. CY8C24094 OCD (Not for Production)

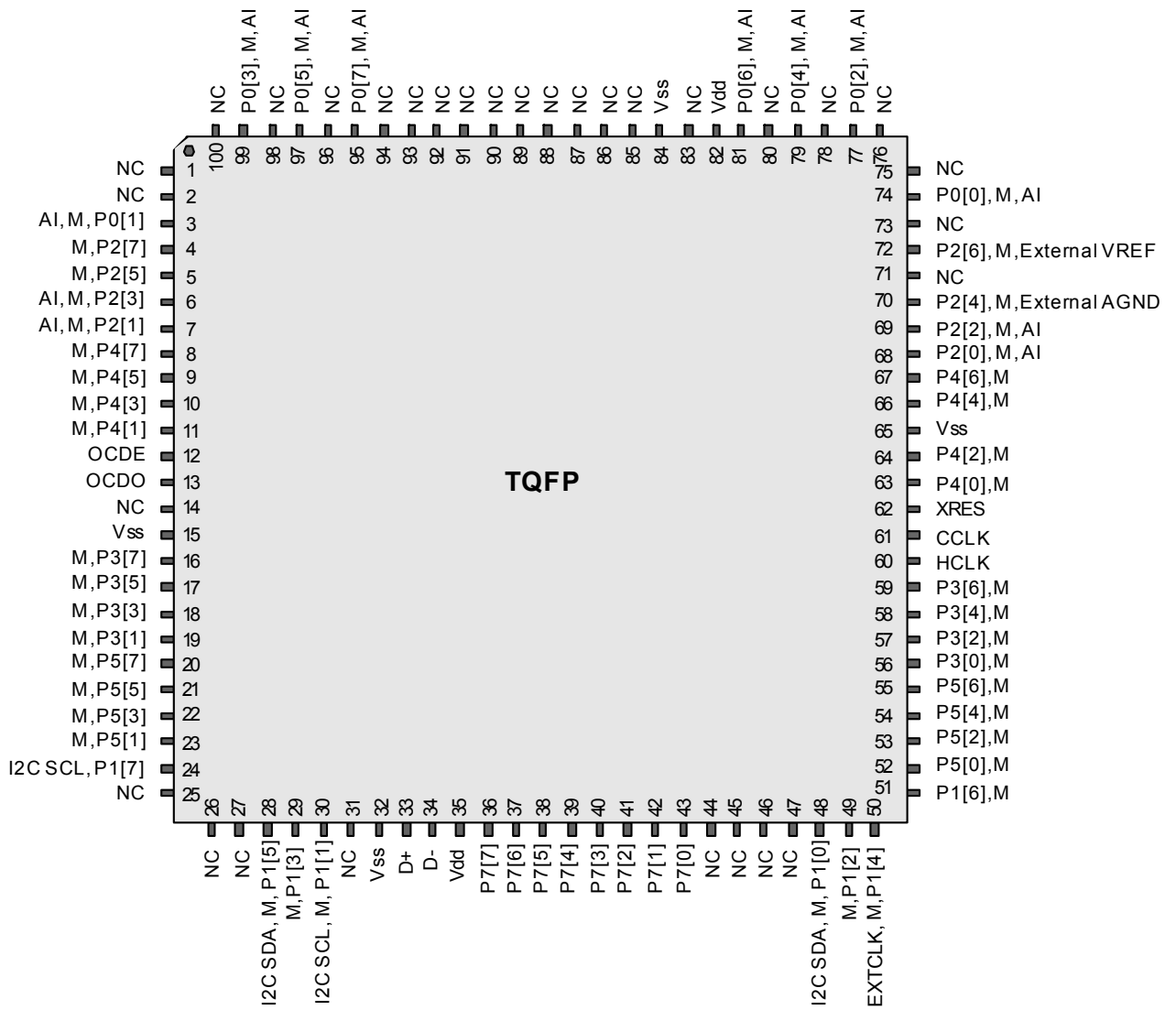

10. Register Reference

This section lists the registers of the CY8C24x94 PSoC device family. For detailed register information, see the [PSoC Technical Reference Manual](#).

10.1 Register Conventions

The register conventions specific to this section are listed in the following table.

Convention	Description
R	Read register or bit(s)
W	Write register or bit(s)
L	Logical register or bit(s)
C	Clearable register or bit(s)
#	Access is bit specific

10.2 Register Mapping Tables

The PSoC device has a total register address space of 512 bytes. The register space is referred to as I/O space and is divided into two banks, Bank 0 and Bank 1. The XO1 bit in the Flag register (CPU_F) determines which bank the user is currently in. When the XO1 bit is set to 1, the user is in Bank 1.

Note In the following register mapping tables, blank fields are Reserved and should not be accessed.

10.3 Register Map Bank 0 Table: User Space

Name	Addr (0, Hex)	Access	Name	Addr (0, Hex)	Access	Name	Addr (0, Hex)	Access	Name	Addr (0, Hex)	Access
PRT0DR	00	RW	PMA0_DR	40	RW	ASC10CR0	80	RW		C0	
PRT0IE	01	RW	PMA1_DR	41	RW	ASC10CR1	81	RW		C1	
PRT0GS	02	RW	PMA2_DR	42	RW	ASC10CR2	82	RW		C2	
PRT0DM2	03	RW	PMA3_DR	43	RW	ASC10CR3	83	RW		C3	
PRT1DR	04	RW	PMA4_DR	44	RW	ASD11CR0	84	RW		C4	
PRT1IE	05	RW	PMA5_DR	45	RW	ASD11CR1	85	RW		C5	
PRT1GS	06	RW	PMA6_DR	46	RW	ASD11CR2	86	RW		C6	
PRT1DM2	07	RW	PMA7_DR	47	RW	ASD11CR3	87	RW		C7	
PRT2DR	08	RW	USB_SOF0	48	R		88			C8	
PRT2IE	09	RW	USB_SOF1	49	R		89			C9	
PRT2GS	0A	RW	USB_CR0	4A	RW		8A			CA	
PRT2DM2	0B	RW	USB/O_CR0	4B	#		8B			CB	
PRT3DR	0C	RW	USB/O_CR1	4C	RW		8C			CC	
PRT3IE	0D	RW		4D			8D			CD	
PRT3GS	0E	RW	EP1_CNT1	4E	#		8E			CE	
PRT3DM2	0F	RW	EP1_CNT	4F	RW		8F			CF	
PRT4DR	10	RW	EP2_CNT1	50	#	ASD20CR0	90	RW	CUR_PP	D0	RW
PRT4IE	11	RW	EP2_CNT	51	RW	ASD20CR1	91	RW	STK_PP	D1	RW
PRT4GS	12	RW	EP3_CNT1	52	#	ASD20CR2	92	RW		D2	
PRT4DM2	13	RW	EP3_CNT	53	RW	ASD20CR3	93	RW	IDX_PP	D3	RW
PRT5DR	14	RW	EP4_CNT1	54	#	ASC21CR0	94	RW	MVR_PP	D4	RW
PRT5IE	15	RW	EP4_CNT	55	RW	ASC21CR1	95	RW	MVW_PP	D5	RW
PRT5GS	16	RW	EP0_CR	56	#	ASC21CR2	96	RW	I2C_CFG	D6	RW
PRT5DM2	17	RW	EP0_CNT	57	#	ASC21CR3	97	RW	I2C_SCR	D7	#
	18		EP0_DR0	58	RW		98		I2C_DR	D8	RW
	19		EP0_DR1	59	RW		99		I2C_MSCR	D9	#
	1A		EP0_DR2	5A	RW		9A		INT_CLR0	DA	RW
	1B		EP0_DR3	5B	RW		9B		INT_CLR1	DB	RW
PRT7DR	1C	RW	EP0_DR4	5C	RW		9C		INT_CLR2	DC	RW
PRT7IE	1D	RW	EP0_DR5	5D	RW		9D		INT_CLR3	DD	RW
PRT7GS	1E	RW	EP0_DR6	5E	RW		9E		INT_MSK3	DE	RW
PRT7DM2	1F	RW	EP0_DR7	5F	RW		9F		INT_MSK2	DF	RW
DBB00DR0	20	#	AMX_IN	60	RW		A0		INT_MSK0	E0	RW
DBB00DR1	21	W	AMUXCFG	61	RW		A1		INT_MSK1	E1	RW
DBB00DR2	22	RW		62			A2		INT_VC	E2	RC
DBB00CR0	23	#	ARF_CR	63	RW		A3		RES_WDT	E3	W
DBB01DR0	24	#	CMP_CR0	64	#		A4		DEC_DH	E4	RC
DBB01DR1	25	W	ASY_CR	65	#		A5		DEC_DL	E5	RC
DBB01DR2	26	RW	CMP_CR1	66	RW		A6		DEC_CR0	E6	RW
DBB01CR0	27	#		67			A7		DEC_CR1	E7	RW
DCB02DR0	28	#		68		MUL1_X	A8	W	MUL0_X	E8	W
DCB02DR1	29	W		69		MUL1_Y	A9	W	MUL0_Y	E9	W
DCB02DR2	2A	RW		6A		MUL1_DH	AA	R	MUL0_DH	EA	R
DCB02CR0	2B	#		6B		MUL1_DL	AB	R	MUL0_DL	EB	R
DCB03DR0	2C	#	TMP_DR0	6C	RW	ACC1_DR1	AC	RW	ACC0_DR1	EC	RW
DCB03DR1	2D	W	TMP_DR1	6D	RW	ACC1_DR0	AD	RW	ACC0_DR0	ED	RW
DCB03DR2	2E	RW	TMP_DR2	6E	RW	ACC1_DR3	AE	RW	ACC0_DR3	EE	RW
DCB03CR0	2F	#	TMP_DR3	6F	RW	ACC1_DR2	AF	RW	ACC0_DR2	EF	RW
	30		ACB00CR3	70	RW	RDI0RI	B0	RW		F0	
	31		ACB00CR0	71	RW	RDI0SYN	B1	RW		F1	
	32		ACB00CR1	72	RW	RDI0IS	B2	RW		F2	
	33		ACB00CR2	73	RW	RDI0LT0	B3	RW		F3	
	34		ACB01CR3	74	RW	RDI0LT1	B4	RW		F4	
	35		ACB01CR0	75	RW	RDI0RO0	B5	RW		F5	
	36		ACB01CR1	76	RW	RDI0RO1	B6	RW		F6	
	37		ACB01CR2	77	RW		B7		CPU_F	F7	RL
	38			78			B8			F8	
	39			79			B9			F9	
	3A			7A			BA			FA	
	3B			7B			BB			FB	
	3C			7C			BC			FC	
	3D			7D			BD		DAC_D	FD	RW
	3E			7E			BE		CPU_SCR1	FE	#
	3F			7F			BF		CPU_SCR0	FF	#

Blank fields are reserved and should not be accessed.

Access is bit specific.

10.4 Register Map Bank 1 Table: Configuration Space

Name	Addr (1, Hex)	Access	Name	Addr (1, Hex)	Access	Name	Addr (1, Hex)	Access	Name	Addr (1, Hex)	Access
PRT0DM0	00	RW	PMA0_WA	40	RW	ASC10CR0	80	RW	USB/O_CR2	C0	RW
PRT0DM1	01	RW	PMA1_WA	41	RW	ASC10CR1	81	RW	USB_CR1	C1	#
PRT0IC0	02	RW	PMA2_WA	42	RW	ASC10CR2	82	RW			
PRT0IC1	03	RW	PMA3_WA	43	RW	ASC10CR3	83	RW			
PRT1DM0	04	RW	PMA4_WA	44	RW	ASD11CR0	84	RW	EP1_CR0	C4	#
PRT1DM1	05	RW	PMA5_WA	45	RW	ASD11CR1	85	RW	EP2_CR0	C5	#
PRT1IC0	06	RW	PMA6_WA	46	RW	ASD11CR2	86	RW	EP3_CR0	C6	#
PRT1IC1	07	RW	PMA7_WA	47	RW	ASD11CR3	87	RW	EP4_CR0	C7	#
PRT2DM0	08	RW		48			88			C8	
PRT2DM1	09	RW		49			89			C9	
PRT2IC0	0A	RW		4A			8A			CA	
PRT2IC1	0B	RW		4B			8B			CB	
PRT3DM0	0C	RW		4C			8C			CC	
PRT3DM1	0D	RW		4D			8D			CD	
PRT3IC0	0E	RW		4E			8E			CE	
PRT3IC1	0F	RW		4F			8F			CF	
PRT4DM0	10	RW	PMA0_RA	50	RW		90		GDI_O_IN	D0	RW
PRT4DM1	11	RW	PMA1_RA	51	RW	ASD20CR1	91	RW	GDI_E_IN	D1	RW
PRT4IC0	12	RW	PMA2_RA	52	RW	ASD20CR2	92	RW	GDI_O_OU	D2	RW
PRT4IC1	13	RW	PMA3_RA	53	RW	ASD20CR3	93	RW	GDI_E_OU	D3	RW
PRT5DM0	14	RW	PMA4_RA	54	RW	ASC21CR0	94	RW		D4	
PRT5DM1	15	RW	PMA5_RA	55	RW	ASC21CR1	95	RW		D5	
PRT5IC0	16	RW	PMA6_RA	56	RW	ASC21CR2	96	RW		D6	
PRT5IC1	17	RW	PMA7_RA	57	RW	ASC21CR3	97	RW		D7	
	18			58			98		MUX_CR0	D8	RW
	19			59			99		MUX_CR1	D9	RW
	1A			5A			9A		MUX_CR2	DA	RW
	1B			5B			9B		MUX_CR3	DB	RW
PRT7DM0	1C	RW		5C			9C			DC	
PRT7DM1	1D	RW		5D			9D		OSC_GO_EN	DD	RW
PRT7IC0	1E	RW		5E			9E		OSC_CR4	DE	RW
PRT7IC1	1F	RW		5F			9F		OSC_CR3	DF	RW
DBB00FN	20	RW	CLK_CR0	60	RW		A0		OSC_CR0	E0	RW
DBB00IN	21	RW	CLK_CR1	61	RW		A1		OSC_CR1	E1	RW
DBB00OU	22	RW	ABF_CR0	62	RW		A2		OSC_CR2	E2	RW
	23		AMD_CR0	63	RW		A3		VLT_CR	E3	RW
DBB01FN	24	RW	CMP_GO_EN	64	RW		A4		VLT_CMP	E4	R
DBB01IN	25	RW		65			A5			E5	
DBB01OU	26	RW	AMD_CR1	66	RW		A6			E6	
	27		ALT_CR0	67	RW		A7			E7	
DCB02FN	28	RW		68			A8		IMO_TR	E8	W
DCB02IN	29	RW		69			A9		ILO_TR	E9	W
DCB02OU	2A	RW		6A			AA		BDG_TR	EA	RW
	2B			6B			AB		ECO_TR	EB	W
DCB03FN	2C	RW	TMP_DR0	6C	RW		AC		MUX_CR4	EC	RW
DCB03IN	2D	RW	TMP_DR1	6D	RW		AD		MUX_CR5	ED	RW
DCB03OU	2E	RW	TMP_DR2	6E	RW		AE			EE	
	2F		TMP_DR3	6F	RW		AF			EF	
	30		ACB00CR3	70	RW	RDI0RI	B0	RW		F0	
	31		ACB00CR0	71	RW	RDI0SYN	B1	RW		F1	
	32		ACB00CR1	72	RW	RDI0IS	B2	RW		F2	
	33		ACB00CR2	73	RW	RDI0LT0	B3	RW		F3	
	34		ACB01CR3	74	RW	RDI0LT1	B4	RW		F4	
	35		ACB01CR0	75	RW	RDI0RO0	B5	RW		F5	
	36		ACB01CR1	76	RW	RDI0RO1	B6	RW		F6	
	37		ACB01CR2	77	RW		B7		CPU_F	F7	RL
	38			78			B8			F8	
	39			79			B9			F9	
	3A			7A			BA			FA	
	3B			7B			BB			FB	
	3C			7C			BC			FC	
	3D			7D			BD		DAC_CR	FD	RW
	3E			7E			BE		CPU_SCR1	FE	#
	3F			7F			BF		CPU_SCR0	FF	#

Blank fields are reserved and should not be accessed.

Access is bit specific.

11. Electrical Specifications

This section presents the DC and AC electrical specifications of the CY8C24x94 PSoC device family. For the most up-to-date electrical specifications, confirm that you have the most recent datasheet by visiting <http://www.cypress.com>.

Specifications are valid for $-40\text{ }^{\circ}\text{C} \leq T_A \leq 85\text{ }^{\circ}\text{C}$ and $T_J \leq 100\text{ }^{\circ}\text{C}$, except where noted. Specifications for devices running at greater than 12 MHz are valid for $-40\text{ }^{\circ}\text{C} \leq T_A \leq 70\text{ }^{\circ}\text{C}$ and $T_J \leq 82\text{ }^{\circ}\text{C}$.

Figure 11. Voltage Versus CPU Frequency

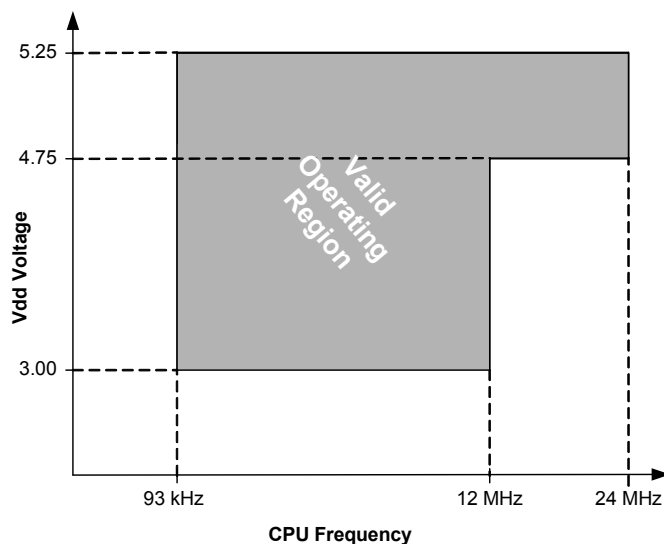

11.1 Absolute Maximum Ratings

Table 9. Absolute Maximum Ratings

Symbol	Description	Min	Typ	Max	Units	Notes
T_{STG}	Storage temperature	-55	25	+100	$^{\circ}\text{C}$	Higher storage temperatures reduces data retention time. Recommended storage temperature is $+25\text{ }^{\circ}\text{C} \pm 25\text{ }^{\circ}\text{C}$. Extended duration storage temperatures higher than $65\text{ }^{\circ}\text{C}$ degrades reliability.
$T_{BAKETEMP}$	Bake temperature	-	125	See package label	$^{\circ}\text{C}$	
$t_{BAKETIME}$	Bake time	See package label	-	72	Hours	
T_A	Ambient temperature with power applied	-40	-	+85	$^{\circ}\text{C}$	
V_{DD}	Supply voltage on V_{DD} relative to V_{SS}	-0.5	-	+6.0	V	
$V_{I/O}$	DC input voltage	$V_{SS} - 0.5$	-	$V_{DD} + 0.5$	V	
$V_{I/O2}$	DC voltage applied to tristate	$V_{SS} - 0.5$	-	$V_{DD} + 0.5$	V	
$I_{MI/O}$	Maximum current into any port pin	-25	-	+50	mA	
$I_{MAI/O}$	Maximum current into any port pin configured as analog driver	-50	-	+50	mA	
ESD	Electrostatic discharge voltage	2000	-	-	V	Human body model ESD.
LU	Latch-up current	-	-	200	mA	

11.2 Operating Temperature

Table 10. Operating Temperature

Symbol	Description	Min	Typ	Max	Units	Notes
T_A	Ambient temperature	-40	-	+85	°C	
T_{AUSB}	Ambient temperature using USB	-10	-	+85	°C	
T_J	Junction temperature	-40	-	+100	°C	The temperature rise from ambient to junction is package specific. See Thermal Impedance on page 51 . The user must limit the power consumption to comply with this requirement.

11.3 DC Electrical Characteristics

11.3.1 DC Chip-Level Specifications

The following table lists guaranteed maximum and minimum specifications for the voltage and temperature ranges: 4.75 V to 5.25 V and $-40\text{ °C} \leq T_A \leq 85\text{ °C}$, or 3.0 V to 3.6 V and $-40\text{ °C} \leq T_A \leq 85\text{ °C}$, respectively. Typical parameters are measured at 5 V and 3.3 V at 25 °C and are for design guidance only.

Table 11. DC Chip-Level Specifications

Symbol	Description	Min	Typ	Max	Units	Notes
V_{DD}	Supply voltage	3.0	-	5.25	V	See DC POR and LVD specifications, Table 22 on page 39 .
I_{DD5}	Supply current, IMO = 24 MHz (5 V)	-	14	27	mA	Conditions are $V_{DD} = 5.0\text{ V}$, $T_A = 25\text{ °C}$, CPU = 3 MHz, SYSCLK doubler disabled, VC1 = 1.5 MHz, VC2 = 93.75 kHz, VC3 = 93.75 kHz, analog power = off.
I_{DD3}	Supply current, IMO = 24 MHz (3.3 V)	-	8	14	mA	Conditions are $V_{DD} = 3.3\text{ V}$, $T_A = 25\text{ °C}$, CPU = 3 MHz, SYSCLK doubler disabled, VC1 = 1.5 MHz, VC2 = 93.75 kHz, VC3 = 0.367 kHz, analog power = off.
I_{SB}	Sleep ^[21] (mode) current with POR, LVD, sleep timer, and WDT. ^[22]	-	3	6.5	μA	Conditions are with internal slow speed oscillator, $V_{DD} = 3.3\text{ V}$, $-40\text{ °C} \leq T_A \leq 55\text{ °C}$, analog power = off.
I_{SBH}	Sleep (mode) current with POR, LVD, Sleep Timer, and WDT at high temperature. ^[22]	-	4	25	μA	Conditions are with internal slow speed oscillator, $V_{DD} = 3.3\text{ V}$, $55\text{ °C} < T_A \leq 85\text{ °C}$, analog power = off.

Notes

21. **Errata:** When the device is operating at 4.75 V to 5.25 V and the 3.3 V regulator is enabled, a short low pulse may be created on the DP signal line during device wake-up. The 15-20 μs low pulse of the DP line may be interpreted by the host computer as a deattach or the beginning of a wake-up. More details in "Errata" on page 66.
22. Standby current includes all functions (POR, LVD, WDT, Sleep Time) needed for reliable system operation. This should be compared with devices that have similar functions enabled.

11.3.2 DC GPIO Specifications

The following table lists guaranteed maximum and minimum specifications for the voltage and temperature ranges: 4.75 V to 5.25 V and $-40\text{ }^{\circ}\text{C} \leq T_A \leq 85\text{ }^{\circ}\text{C}$, or 3.0 V to 3.6 V and $-40\text{ }^{\circ}\text{C} \leq T_A \leq 85\text{ }^{\circ}\text{C}$, respectively. Typical parameters are measured at 5 V and 3.3 V at 25 °C and are for design guidance only.

Table 12. DC GPIO Specifications

Symbol	Description	Min	Typ	Max	Units	Notes
R _{PU}	Pull-up resistor	4	5.6	8	kΩ	
R _{PD}	Pull-down resistor	4	5.6	8	kΩ	
V _{OH}	High output level	V _{DD} - 1.0	–	–	V	I _{OH} = 10 mA, V _{DD} = 4.75 V to 5.25 V and $-40\text{ }^{\circ}\text{C} \leq T_A \leq 85\text{ }^{\circ}\text{C}$, or V _{DD} = 3.0 V to 3.6 V and $-40\text{ }^{\circ}\text{C} \leq T_A \leq 85\text{ }^{\circ}\text{C}$ (8 total loads, 4 on even port pins (for example, P0[2], P1[4]), 4 on odd port pins (for example, P0[3], P1[5])). 80 mA maximum combined I _{OH} budget.
V _{OL}	Low output level	–	–	0.75	V	I _{OL} = 25 mA, V _{DD} = 4.75 V to 5.25 V and $-40\text{ }^{\circ}\text{C} \leq T_A \leq 85\text{ }^{\circ}\text{C}$, or V _{DD} = 3.0 V to 3.6 V and $-40\text{ }^{\circ}\text{C} \leq T_A \leq 85\text{ }^{\circ}\text{C}$ (8 total loads, 4 on even port pins (for example, P0[2], P1[4]), 4 on odd port pins (for example, P0[3], P1[5])). 200 mA maximum combined I _{OL} budget.
I _{OH}	High level source current	10	–	–	mA	V _{OH} = V _{DD} - 1.0 V, see the limitations of the total current in the note for V _{OH}
I _{OL}	Low level sink current	25	–	–	mA	V _{OL} = 0.75 V, see the limitations of the total current in the note for V _{OL}
V _{IL}	Input low level	–	–	0.8	V	V _{DD} = 3.0 to 5.25.
V _{IH}	Input high level	2.1	–	–	V	V _{DD} = 3.0 to 5.25.
V _H	Input hysteresis	–	60	–	mV	
I _{IL}	Input leakage (absolute value)	–	1	–	nA	Gross tested to 1 μA.
C _{IN}	Capacitive load on pins as input	–	3.5	10	pF	Package and pin dependent. Temp = 25 °C.
C _{OUT}	Capacitive load on pins as output	–	3.5	10	pF	Package and pin dependent. Temp = 25 °C.

11.3.3 DC Full Speed USB Specifications

The following table lists guaranteed maximum and minimum specifications for the voltage and temperature ranges: 4.75 V to 5.25 V and $-10\text{ }^{\circ}\text{C} \leq T_A \leq 85\text{ }^{\circ}\text{C}$, or 3.0 V to 3.6 V and $-10\text{ }^{\circ}\text{C} \leq T_A \leq 85\text{ }^{\circ}\text{C}$, respectively. Typical parameters are measured at 5 V and 3.3 V at 25 °C and are for design guidance only.

Table 13. DC Full Speed (12 Mbps) USB Specifications

Symbol	Description	Min	Typ	Max	Units	Notes
USB Interface						
V _{DI}	Differential input sensitivity	0.2	–	–	V	(D+) – (D–)
V _{CM}	Differential input common mode range	0.8	–	2.5	V	
V _{SE}	Single ended receiver threshold	0.8	–	2.0	V	
C _{IN}	Transceiver capacitance	–	–	20	pF	
I _{I/O}	High Z state data line leakage	–10	–	10	μA	0 V < V _{IN} < 3.3 V.
R _{EXT}	External USB series resistor	23	–	25	Ω	In series with each USB pin.
V _{UOH}	Static output high, driven	2.8	–	3.6	V	15 kΩ ± 5% to ground. Internal pull-up enabled.
V _{UOHI}	Static output high, idle	2.7	–	3.6	V	15 kΩ ± 5% to ground. Internal pull-up enabled.
V _{UOL}	Static output low	–	–	0.3	V	15 kΩ ± 5% to ground. Internal pull-up enabled.
Z _O	USB driver output impedance	28	–	44	Ω	Including R _{EXT} resistor.
V _{CRS}	D+/D– crossover voltage	1.3	–	2.0	V	

11.3.4 DC Operational Amplifier Specifications

The following tables list guaranteed maximum and minimum specifications for the voltage and temperature ranges: 4.75 V to 5.25 V and $-40\text{ }^{\circ}\text{C} \leq T_A \leq 85\text{ }^{\circ}\text{C}$, or 3.0 V to 3.6 V and $-40\text{ }^{\circ}\text{C} \leq T_A \leq 85\text{ }^{\circ}\text{C}$, respectively. Typical parameters are measured at 5 V and 3.3 V at 25 °C and are for design guidance only.

The operational amplifier is a component of both the analog continuous time PSoC blocks and the analog switched capacitor PSoC blocks. The guaranteed specifications are measured in the analog continuous time PSoC block.

Table 14. 5-V DC Operational Amplifier Specifications

Symbol	Description	Min	Typ	Max	Units	Notes
V_{OSOA}	Input offset voltage (absolute value)	–	1.6	10	mV	
	Power = low, Opamp bias = high	–	1.3	8	mV	
	Power = medium, Opamp bias = high	–	1.2	7.5	mV	
TCV_{OSOA}	Average input offset voltage drift	–	7.0	35.0	$\mu\text{V}/^{\circ}\text{C}$	
I_{EBOA}	Input leakage current (Port 0 analog pins)	–	20	–	pA	Gross tested to 1 μA .
C_{INOA}	Input capacitance (Port 0 analog pins)	–	4.5	9.5	pF	Package and pin dependent. Temp = 25 °C.
V_{CMOA}	Common mode voltage range	0.0	–	V_{DD}	V	The common-mode input voltage range is measured through an analog output buffer. The specification includes the limitations imposed by the characteristics of the analog output buffer.
	Common mode voltage range (high power or high Opamp bias)	0.5	–	$V_{DD} - 0.5$	V	
G_{OLOA}	Open loop gain	–	–	–	–	
	Power = low, Opamp bias = high	60	–	–	dB	
	Power = medium, Opamp bias = high	60	–	–	dB	
$V_{OHIGHOA}$	High output voltage swing (internal signals)	–	–	–	–	
	Power = low, Opamp bias = high	$V_{DD} - 0.2$	–	–	V	
	Power = medium, Opamp bias = high	$V_{DD} - 0.2$	–	–	V	
V_{OLOWOA}	Low output voltage swing (internal signals)	–	–	–	–	
	Power = low, Opamp bias = high	–	–	0.2	V	
	Power = medium, Opamp bias = high	–	–	0.2	V	
I_{SOA}	Supply current (including associated AGND buffer)	–	–	–	–	
	Power = low, Opamp bias = low	–	400	800	μA	
	Power = low, Opamp bias = high	–	500	900	μA	
$PSRR_{OA}$	Power = medium, Opamp bias = low	–	800	1000	μA	
	Power = medium, Opamp bias = high	–	1200	1600	μA	
	Power = high, Opamp bias = low	–	2400	3200	μA	
$PSRR_{OA}$	Power = high, Opamp bias = high	–	4600	6400	μA	
	Supply voltage rejection ratio	65	80	–	dB	$V_{SS} \leq V_{IN} \leq (V_{DD} - 2.25)$ or $(V_{DD} - 1.25\text{ V}) \leq V_{IN} \leq V_{DD}$.

Table 15. 3.3-V DC Operational Amplifier Specifications

Symbol	Description	Min	Typ	Max	Units	Notes
$V_{OSO A}$	Input offset voltage (absolute value)	–	1.65	10	mV	Power = high, Opamp bias = high setting is not allowed for 3.3 V V_{DD} operation
	Power = low, Opamp bias = high	–	1.32	8	mV	
	Power = medium, Opamp bias = high	–	–	–	mV	
	Power = high, Opamp bias = high	–	–	–	mV	
$TCV_{OSO A}$	Average input offset voltage drift	–	7.0	35.0	$\mu V/^{\circ}C$	
$I_{EBO A}$	Input leakage current (port 0 analog pins)	–	20	–	pA	Gross tested to 1 μA .
$C_{INO A}$	Input capacitance (port 0 analog pins)	–	4.5	9.5	pF	Package and pin dependent. Temp = 25 $^{\circ}C$.
$V_{CMO A}$	Common mode voltage range	0.2	–	$V_{DD} - 0.2$	V	The common-mode input voltage range is measured through an analog output buffer. The specification includes the limitations imposed by the characteristics of the analog output buffer.
$G_{OLO A}$	Open loop gain	60	–	–	dB	Specification is applicable at Low opamp bias. For high opamp bias mode (except high power, High opamp bias), minimum is 60 dB.
	Power = low, Opamp bias = low	60	–	–	dB	
	Power = high, Opamp bias = low	80	–	–	dB	
$V_{OHIGHO A}$	High output voltage swing (internal signals)	$V_{DD} - 0.2$	–	–	V	Power = high, Opamp bias = high setting is not allowed for 3.3 V V_{DD} operation
	Power = low, Opamp bias = low	$V_{DD} - 0.2$	–	–	V	
	Power = high, Opamp bias = low	$V_{DD} - 0.2$	–	–	V	
$V_{OLOWO A}$	Low output voltage swing (internal signals)	–	–	0.2	V	Power = high, Opamp bias = high setting is not allowed for 3.3 V V_{DD} operation
	Power = low, Opamp bias = low	–	–	0.2	V	
	Power = high, Opamp bias = low	–	–	0.2	V	
$I_{SO A}$	Supply current (including associated AGND buffer)	–	–	–	μA	Power = high, Opamp bias = high setting is not allowed for 3.3 V V_{DD} operation
	Power = low, Opamp bias = low	–	400	800	μA	
	Power = low, Opamp bias = high	–	500	900	μA	
	Power = medium, Opamp bias = low	–	800	1000	μA	
	Power = medium, Opamp bias = high	–	1200	1600	μA	
	Power = high, Opamp bias = low	–	2400	3200	μA	
Power = high, Opamp bias = high	–	–	–	μA		
$PSRR_{O A}$	Supply voltage rejection ratio	65	80	–	dB	$V_{SS} \leq V_{IN} \leq (V_{DD} - 2.25)$ or $(V_{DD} - 1.25 V) \leq V_{IN} \leq V_{DD}$

11.3.5 DC Low Power Comparator Specifications

The following table lists guaranteed maximum and minimum specifications for the voltage and temperature ranges: 4.75 V to 5.25 V and $-40^{\circ}C \leq T_A \leq 85^{\circ}C$ or 3.0 V to 3.6 V and $-40^{\circ}C \leq T_A \leq 85^{\circ}C$, respectively. Typical parameters are measured at 5 V at 25 $^{\circ}C$ and are for design guidance only.

Table 16. DC Low Power Comparator Specifications

Symbol	Description	Min	Typ	Max	Units	Notes
V_{REFLPC}	Low power comparator (LPC) reference voltage range	0.2	–	$V_{DD} - 1$	V	
I_{SLPC}	LPC supply current	–	10	40	μA	
V_{OSLPC}	LPC voltage offset	–	2.5	30	mV	

11.3.6 DC Analog Output Buffer Specifications

The following tables list guaranteed maximum and minimum specifications for the voltage and temperature ranges: 4.75 V to 5.25 V and $-40\text{ }^{\circ}\text{C} \leq T_A \leq 85\text{ }^{\circ}\text{C}$, or 3.0 V to 3.6 V and $-40\text{ }^{\circ}\text{C} \leq T_A \leq 85\text{ }^{\circ}\text{C}$, respectively. Typical parameters are measured at 5 V and 3.3 V at 25 $^{\circ}\text{C}$ and are for design guidance only.

Table 17. 5-V DC Analog Output Buffer Specifications

Symbol	Description	Min	Typ	Max	Units	Notes
C_L	Load Capacitance	–	–	200	pF	This specification applies to the external circuit that is being driven by the analog output buffer.
V_{OSOB}	Input offset voltage (absolute value)	–	3	12	mV	
TCV_{OSOB}	Average input offset voltage drift	–	+6	–	$\mu\text{V}/^{\circ}\text{C}$	
V_{CMOB}	Common mode input voltage range	0.5	–	$V_{DD} - 1.0$	V	
R_{OUTOB}	Output resistance Power = low Power = high	– –	0.6 0.6	– –	Ω Ω	
$V_{OHIGHOB}$	High output voltage swing (Load = 32 ohms to $V_{DD}/2$) Power = low Power = high	$0.5 \times V_{DD} + 1.1$ $0.5 \times V_{DD} + 1.1$	– –	– –	V V	
V_{OLOWOB}	Low output voltage swing (Load = 32 ohms to $V_{DD}/2$) Power = low Power = high	– –	– –	$0.5 \times V_{DD} - 1.3$ $0.5 \times V_{DD} - 1.3$	V V	
I_{SOB}	Supply current including opamp bias cell (No Load) Power = low Power = high	– –	1.1 2.6	5.1 8.8	mA mA	
$PSRR_{OB}$	Supply voltage rejection ratio	53	64	–	dB	$(0.5 \times V_{DD} - 1.3) \leq V_{OUT} \leq (V_{DD} - 2.3)$.

Table 18. 3.3-V DC Analog Output Buffer Specifications

Symbol	Description	Min	Typ	Max	Units	Notes
C_L	Load Capacitance	–	–	200	pF	This specification applies to the external circuit that is being driven by the analog output buffer.
V_{OSOB}	Input offset voltage (absolute value)	–	3	12	mV	
TCV_{OSOB}	Average input offset voltage drift	–	+6	–	$\mu\text{V}/^\circ\text{C}$	
V_{CMOB}	Common mode input voltage range	0.5	–	$V_{DD} - 1.0$	V	
R_{OUTOB}	Output resistance Power = low Power = high	– –	1 1	– –	W W	
$V_{OHIGHOB}$	High output voltage swing (Load = 1 K ohms to $V_{DD}/2$) Power = low Power = high	$0.5 \times V_{DD} + 1.0$ $0.5 \times V_{DD} + 1.0$	– –	– –	V V	
V_{OLOWOB}	Low output voltage swing (Load = 1 K ohms to $V_{DD}/2$) Power = low Power = high	– –	– –	$0.5 \times V_{DD} - 1.0$ $0.5 \times V_{DD} - 1.0$	V V	
I_{SOB}	Supply current including opamp bias cell (No load) Power = low Power = high	– –	0.8 2.0	2.0 4.3	mA mA	
$PSRR_{OB}$	Supply voltage rejection ratio	34	64	–	dB	$(0.5 \times V_{DD} - 1.0) \leq V_{OUT} \leq (0.5 \times V_{DD} + 0.9)$.

11.3.7 DC Analog Reference Specifications

The following tables list guaranteed maximum and minimum specifications for the voltage and temperature ranges: 4.75 V to 5.25 V and $-40\text{ }^{\circ}\text{C} \leq T_A \leq 85\text{ }^{\circ}\text{C}$, or 3.0 V to 3.6 V and $-40\text{ }^{\circ}\text{C} \leq T_A \leq 85\text{ }^{\circ}\text{C}$, respectively. Typical parameters apply to 5 V and 3.3 V at 25 °C and are for design guidance only.

The guaranteed specifications for RefHi and RefLo are measured through the Analog Continuous Time PSoC blocks. The power levels for RefHi and RefLo refer to the Analog Reference Control register. AGND is measured at P2[4] in AGND bypass mode. Each Analog Continuous Time PSoC block adds a maximum of 10mV additional offset error to guaranteed AGND specifications from the local AGND buffer. Reference control power can be set to medium or high unless otherwise noted.

Note Avoid using P2[4] for digital signaling when using an analog resource that depends on the Analog Reference. Some coupling of the digital signal may appear on the AGND.

Table 19. 5-V DC Analog Reference Specifications

Reference ARF_CR [5:3]	Reference Power Settings	Symbol	Reference	Description	Min	Typ	Max	Units
0b000	RefPower = high Opamp bias = high	V _{REFHI}	Ref High	V _{DD} /2 + Bandgap	V _{DD} /2 + 1.229	V _{DD} /2 + 1.290	V _{DD} /2 + 1.346	V
		V _{AGND}	AGND	V _{DD} /2	V _{DD} /2 – 0.038	V _{DD} /2	V _{DD} /2 + 0.040	V
		V _{REFLO}	Ref Low	V _{DD} /2 – Bandgap	V _{DD} /2 – 1.356	V _{DD} /2 – 1.295	V _{DD} /2 – 1.218	V
	RefPower = high Opamp bias = low	V _{REFHI}	Ref High	V _{DD} /2 + Bandgap	V _{DD} /2 + 1.220	V _{DD} /2 + 1.292	V _{DD} /2 + 1.348	V
		V _{AGND}	AGND	V _{DD} /2	V _{DD} /2 – 0.036	V _{DD} /2	V _{DD} /2 + 0.036	V
		V _{REFLO}	Ref Low	V _{DD} /2 – Bandgap	V _{DD} /2 – 1.357	V _{DD} /2 – 1.297	V _{DD} /2 – 1.225	V
	RefPower = medium Opamp bias = high	V _{REFHI}	Ref High	V _{DD} /2 + Bandgap	V _{DD} /2 + 1.221	V _{DD} /2 + 1.293	V _{DD} /2 + 1.351	V
		V _{AGND}	AGND	V _{DD} /2	V _{DD} /2 – 0.036	V _{DD} /2	V _{DD} /2 + 0.036	V
		V _{REFLO}	Ref Low	V _{DD} /2 – Bandgap	V _{DD} /2 – 1.357	V _{DD} /2 – 1.298	V _{DD} /2 – 1.228	V
	RefPower = medium Opamp bias = low	V _{REFHI}	Ref High	V _{DD} /2 + Bandgap	V _{DD} /2 + 1.219	V _{DD} /2 + 1.293	V _{DD} /2 + 1.353	V
		V _{AGND}	AGND	V _{DD} /2	V _{DD} /2 – 0.037	V _{DD} /2 – 0.001	V _{DD} /2 + 0.036	V
		V _{REFLO}	Ref Low	V _{DD} /2 – Bandgap	V _{DD} /2 – 1.359	V _{DD} /2 – 1.299	V _{DD} /2 – 1.229	V

Table 19. 5-V DC Analog Reference Specifications (continued)

Reference ARF_CR [5:3]	Reference Power Settings	Symbol	Reference	Description	Min	Typ	Max	Units
0b001	RefPower = high Opamp bias = high	V _{REFHI}	Ref High	P2[4]+P2[6] (P2[4] = V _{DD} /2, P2[6] = 1.3 V)	P2[4] + P2[6] - 0.092	P2[4] + P2[6] - 0.011	P2[4] + P2[6] + 0.064	V
		V _{AGND}	AGND	P2[4]	P2[4]	P2[4]	P2[4]	-
		V _{REFLO}	Ref Low	P2[4]-P2[6] (P2[4] = V _{DD} /2, P2[6] = 1.3 V)	P2[4] - P2[6] - 0.031	P2[4] - P2[6] + 0.007	P2[4] - P2[6] + 0.056	V
	RefPower = high Opamp bias = low	V _{REFHI}	Ref High	P2[4]+P2[6] (P2[4] = V _{DD} /2, P2[6] = 1.3 V)	P2[4] + P2[6] - 0.078	P2[4] + P2[6] - 0.008	P2[4] + P2[6] + 0.063	V
		V _{AGND}	AGND	P2[4]	P2[4]	P2[4]	P2[4]	-
		V _{REFLO}	Ref Low	P2[4]-P2[6] (P2[4] = V _{DD} /2, P2[6] = 1.3 V)	P2[4] - P2[6] - 0.031	P2[4] - P2[6] + 0.004	P2[4] - P2[6] + 0.043	V
	RefPower = medium Opamp bias = high	V _{REFHI}	Ref High	P2[4]+P2[6] (P2[4] = V _{DD} /2, P2[6] = 1.3 V)	P2[4] + P2[6] - 0.073	P2[4] + P2[6] - 0.006	P2[4] + P2[6] + 0.062	V
		V _{AGND}	AGND	P2[4]	P2[4]	P2[4]	P2[4]	-
		V _{REFLO}	Ref Low	P2[4]-P2[6] (P2[4] = V _{DD} /2, P2[6] = 1.3 V)	P2[4] - P2[6] - 0.032	P2[4] - P2[6] + 0.003	P2[4] - P2[6] + 0.038	V
	RefPower = medium Opamp bias = low	V _{REFHI}	Ref High	P2[4]+P2[6] (P2[4] = V _{DD} /2, P2[6] = 1.3 V)	P2[4] + P2[6] - 0.073	P2[4] + P2[6] - 0.006	P2[4] + P2[6] + 0.062	V
		V _{AGND}	AGND	P2[4]	P2[4]	P2[4]	P2[4]	-
		V _{REFLO}	Ref Low	P2[4]-P2[6] (P2[4] = V _{DD} /2, P2[6] = 1.3 V)	P2[4] - P2[6] - 0.034	P2[4] - P2[6] + 0.002	P2[4] - P2[6] + 0.037	V
0b010	RefPower = high Opamp bias = high	V _{REFHI}	Ref High	V _{DD}	V _{DD} - 0.037	V _{DD} - 0.007	V _{DD}	V
		V _{AGND}	AGND	V _{DD} /2	V _{DD} /2 - 0.036	V _{DD} /2 - 0.001	V _{DD} /2 + 0.036	V
		V _{REFLO}	Ref Low	V _{SS}	V _{SS}	V _{SS} + 0.005	V _{SS} + 0.029	V
	RefPower = high Opamp bias = low	V _{REFHI}	Ref High	V _{DD}	V _{DD} - 0.034	V _{DD} - 0.006	V _{DD}	V
		V _{AGND}	AGND	V _{DD} /2	V _{DD} /2 - 0.036	V _{DD} /2 - 0.001	V _{DD} /2 + 0.035	V
		V _{REFLO}	Ref Low	V _{SS}	V _{SS}	V _{SS} + 0.004	V _{SS} + 0.024	V
	RefPower = medium Opamp bias = high	V _{REFHI}	Ref High	V _{DD}	V _{DD} - 0.032	V _{DD} - 0.005	V _{DD}	V
		V _{AGND}	AGND	V _{DD} /2	V _{DD} /2 - 0.036	V _{DD} /2 - 0.001	V _{DD} /2 + 0.035	V
		V _{REFLO}	Ref Low	V _{SS}	V _{SS}	V _{SS} + 0.003	V _{SS} + 0.022	V
	RefPower = medium Opamp bias = low	V _{REFHI}	Ref High	V _{DD}	V _{DD} - 0.031	V _{DD} - 0.005	V _{DD}	V
		V _{AGND}	AGND	V _{DD} /2	V _{DD} /2 - 0.037	V _{DD} /2 - 0.001	V _{DD} /2 + 0.035	V
		V _{REFLO}	Ref Low	V _{SS}	V _{SS}	V _{SS} + 0.003	V _{SS} + 0.020	V

Table 19. 5-V DC Analog Reference Specifications (continued)

Reference ARF_CR [5:3]	Reference Power Settings	Symbol	Reference	Description	Min	Typ	Max	Units
0b011	RefPower = high Opamp bias = high	V _{REFHI}	Ref High	3 × Bandgap	3.760	3.884	4.006	V
		V _{AGND}	AGND	2 × Bandgap	2.522	2.593	2.669	V
		V _{REFLO}	Ref Low	Bandgap	1.252	1.299	1.342	V
	RefPower = high Opamp bias = low	V _{REFHI}	Ref High	3 × Bandgap	3.766	3.887	4.010	V
		V _{AGND}	AGND	2 × Bandgap	2.523	2.594	2.670	V
		V _{REFLO}	Ref Low	Bandgap	1.252	1.297	1.342	V
	RefPower = medium Opamp bias = high	V _{REFHI}	Ref High	3 × Bandgap	3.769	3.888	4.013	V
		V _{AGND}	AGND	2 × Bandgap	2.523	2.594	2.671	V
		V _{REFLO}	Ref Low	Bandgap	1.251	1.296	1.343	V
RefPower = medium Opamp bias = low	V _{REFHI}	Ref High	3 × Bandgap	3.769	3.889	4.015	V	
	V _{AGND}	AGND	2 × Bandgap	2.523	2.595	2.671	V	
	V _{REFLO}	Ref Low	Bandgap	1.251	1.296	1.344	V	
0b100	RefPower = high Opamp bias = high	V _{REFHI}	Ref High	2 × Bandgap + P2[6] (P2[6] = 1.3 V)	2.483 + P2[6]	2.582 + P2[6]	2.674 + P2[6]	V
		V _{AGND}	AGND	2 × Bandgap	2.522	2.593	2.669	V
		V _{REFLO}	Ref Low	2 × Bandgap – P2[6] (P2[6] = 1.3 V)	2.524 – P2[6]	2.600 – P2[6]	2.676 – P2[6]	V
	RefPower = high Opamp bias = low	V _{REFHI}	Ref High	2 × Bandgap + P2[6] (P2[6] = 1.3 V)	2.490 + P2[6]	2.586 + P2[6]	2.679 + P2[6]	V
		V _{AGND}	AGND	2 × Bandgap	2.523	2.594	2.669	V
		V _{REFLO}	Ref Low	2 × Bandgap – P2[6] (P2[6] = 1.3 V)	2.523 – P2[6]	2.598 – P2[6]	2.675 – P2[6]	V
	RefPower = medium Opamp bias = high	V _{REFHI}	Ref High	2 × Bandgap + P2[6] (P2[6] = 1.3 V)	2.493 + P2[6]	2.588 + P2[6]	2.682 + P2[6]	V
		V _{AGND}	AGND	2 × Bandgap	2.523	2.594	2.670	V
		V _{REFLO}	Ref Low	2 × Bandgap – P2[6] (P2[6] = 1.3 V)	2.523 – P2[6]	2.597 – P2[6]	2.675 – P2[6]	V
	RefPower = medium Opamp bias = low	V _{REFHI}	Ref High	2 × Bandgap + P2[6] (P2[6] = 1.3 V)	2.494 + P2[6]	2.589 + P2[6]	2.685 + P2[6]	V
		V _{AGND}	AGND	2 × Bandgap	2.523	2.595	2.671	V
		V _{REFLO}	Ref Low	2 × Bandgap – P2[6] (P2[6] = 1.3 V)	2.522 – P2[6]	2.596 – P2[6]	2.676 – P2[6]	V

Table 19. 5-V DC Analog Reference Specifications (continued)

Reference ARF_CR [5:3]	Reference Power Settings	Symbol	Reference	Description	Min	Typ	Max	Units
0b101	RefPower = high Opamp bias = high	V _{REFHI}	Ref High	P2[4] + Bandgap (P2[4] = V _{DD} /2)	P2[4] + 1.218	P2[4] + 1.291	P2[4] + 1.354	V
		V _{AGND}	AGND	P2[4]	P2[4]	P2[4]	P2[4]	–
		V _{REFLO}	Ref Low	P2[4] – Bandgap (P2[4] = V _{DD} /2)	P2[4] – 1.335	P2[4] – 1.294	P2[4] – 1.237	V
	RefPower = high Opamp bias = low	V _{REFHI}	Ref High	P2[4] + Bandgap (P2[4] = V _{DD} /2)	P2[4] + 1.221	P2[4] + 1.293	P2[4] + 1.358	V
		V _{AGND}	AGND	P2[4]	P2[4]	P2[4]	P2[4]	–
		V _{REFLO}	Ref Low	P2[4] – Bandgap (P2[4] = V _{DD} /2)	P2[4] – 1.337	P2[4] – 1.297	P2[4] – 1.243	V
	RefPower = medium Opamp bias = high	V _{REFHI}	Ref High	P2[4] + Bandgap (P2[4] = V _{DD} /2)	P2[4] + 1.222	P2[4] + 1.294	P2[4] + 1.360	V
		V _{AGND}	AGND	P2[4]	P2[4]	P2[4]	P2[4]	–
		V _{REFLO}	Ref Low	P2[4] – Bandgap (P2[4] = V _{DD} /2)	P2[4] – 1.338	P2[4] – 1.298	P2[4] – 1.245	V
	RefPower = medium Opamp bias = low	V _{REFHI}	Ref High	P2[4] + Bandgap (P2[4] = V _{DD} /2)	P2[4] + 1.221	P2[4] + 1.294	P2[4] + 1.362	V
		V _{AGND}	AGND	P2[4]	P2[4]	P2[4]	P2[4]	–
		V _{REFLO}	Ref Low	P2[4] – Bandgap (P2[4] = V _{DD} /2)	P2[4] – 1.340	P2[4] – 1.298	P2[4] – 1.245	V
0b110	RefPower = high Opamp bias = high	V _{REFHI}	Ref High	2 × Bandgap	2.513	2.593	2.672	V
		V _{AGND}	AGND	Bandgap	1.264	1.302	1.340	V
		V _{REFLO}	Ref Low	V _{SS}	V _{SS}	V _{SS} + 0.008	V _{SS} + 0.038	V
	RefPower = high Opamp bias = low	V _{REFHI}	Ref High	2 × Bandgap	2.514	2.593	2.674	V
		V _{AGND}	AGND	Bandgap	1.264	1.301	1.340	V
		V _{REFLO}	Ref Low	V _{SS}	V _{SS}	V _{SS} + 0.005	V _{SS} + 0.028	V
	RefPower = medium Opamp bias = high	V _{REFHI}	Ref High	2 × Bandgap	2.514	2.593	2.676	V
		V _{AGND}	AGND	Bandgap	1.264	1.301	1.340	V
		V _{REFLO}	Ref Low	V _{SS}	V _{SS}	V _{SS} + 0.004	V _{SS} + 0.024	V
	RefPower = medium Opamp bias = low	V _{REFHI}	Ref High	2 × Bandgap	2.514	2.593	2.677	V
		V _{AGND}	AGND	Bandgap	1.264	1.300	1.340	V
		V _{REFLO}	Ref Low	V _{SS}	V _{SS}	V _{SS} + 0.003	V _{SS} + 0.021	V

Table 19. 5-V DC Analog Reference Specifications (continued)

Reference ARF_CR [5:3]	Reference Power Settings	Symbol	Reference	Description	Min	Typ	Max	Units
0b111	RefPower = high Opamp bias = high	V _{REFHI}	Ref High	3.2 × Bandgap	4.028	4.144	4.242	V
		V _{AGND}	AGND	1.6 × Bandgap	2.028	2.076	2.125	V
		V _{REFLO}	Ref Low	V _{SS}	V _{SS}	V _{SS} + 0.008	V _{SS} + 0.034	V
	RefPower = high Opamp bias = low	V _{REFHI}	Ref High	3.2 × Bandgap	4.032	4.142	4.245	V
		V _{AGND}	AGND	1.6 × Bandgap	2.029	2.076	2.126	V
		V _{REFLO}	Ref Low	V _{SS}	V _{SS}	V _{SS} + 0.005	V _{SS} + 0.025	V
	RefPower = medium Opamp bias = high	V _{REFHI}	Ref High	3.2 × Bandgap	4.034	4.143	4.247	V
		V _{AGND}	AGND	1.6 × Bandgap	2.029	2.076	2.126	V
		V _{REFLO}	Ref Low	V _{SS}	V _{SS}	V _{SS} + 0.004	V _{SS} + 0.021	V
	RefPower = medium Opamp bias = low	V _{REFHI}	Ref High	3.2 × Bandgap	4.036	4.144	4.249	V
		V _{AGND}	AGND	1.6 × Bandgap	2.029	2.076	2.126	V
		V _{REFLO}	Ref Low	V _{SS}	V _{SS}	V _{SS} + 0.003	V _{SS} + 0.019	V

Table 20. 3.3-V DC Analog Reference Specifications

Reference ARF_CR [5:3]	Reference Power Settings	Symbol	Reference	Description	Min	Typ	Max	Units
0b000	RefPower = high Opamp bias = high	V _{REFHI}	Ref High	V _{DD} /2 + Bandgap	V _{DD} /2 + 1.200	V _{DD} /2 + 1.290	V _{DD} /2 + 1.365	V
		V _{AGND}	AGND	V _{DD} /2	V _{DD} /2 – 0.030	V _{DD} /2	V _{DD} /2 + 0.034	V
		V _{REFLO}	Ref Low	V _{DD} /2 – Bandgap	V _{DD} /2 – 1.346	V _{DD} /2 – 1.292	V _{DD} /2 – 1.208	V
	RefPower = high Opamp bias = low	V _{REFHI}	Ref High	V _{DD} /2 + Bandgap	V _{DD} /2 + 1.196	V _{DD} /2 + 1.292	V _{DD} /2 + 1.374	V
		V _{AGND}	AGND	V _{DD} /2	V _{DD} /2 – 0.029	V _{DD} /2	V _{DD} /2 + 0.031	V
		V _{REFLO}	Ref Low	V _{DD} /2 – Bandgap	V _{DD} /2 – 1.349	V _{DD} /2 – 1.295	V _{DD} /2 – 1.227	V
	RefPower = medium Opamp bias = high	V _{REFHI}	Ref High	V _{DD} /2 + Bandgap	V _{DD} /2 + 1.204	V _{DD} /2 + 1.293	V _{DD} /2 + 1.369	V
		V _{AGND}	AGND	V _{DD} /2	V _{DD} /2 – 0.030	V _{DD} /2	V _{DD} /2 + 0.030	V
		V _{REFLO}	Ref Low	V _{DD} /2 – Bandgap	V _{DD} /2 – 1.351	V _{DD} /2 – 1.297	V _{DD} /2 – 1.229	V
	RefPower = medium Opamp bias = low	V _{REFHI}	Ref High	V _{DD} /2 + Bandgap	V _{DD} /2 + 1.189	V _{DD} /2 + 1.294	V _{DD} /2 + 1.384	V
		V _{AGND}	AGND	V _{DD} /2	V _{DD} /2 – 0.032	V _{DD} /2	V _{DD} /2 + 0.029	V
		V _{REFLO}	Ref Low	V _{DD} /2 – Bandgap	V _{DD} /2 – 1.353	V _{DD} /2 – 1.297	V _{DD} /2 – 1.230	V
0b001	RefPower = high Opamp bias = high	V _{REFHI}	Ref High	P2[4]+P2[6] (P2[4] = V _{DD} /2, P2[6] = 0.5 V)	P2[4] + P2[6] – 0.105	P2[4] + P2[6] – 0.008	P2[4] + P2[6] + 0.095	V
		V _{AGND}	AGND	P2[4]	P2[4]	P2[4]	P2[4]	–
		V _{REFLO}	Ref Low	P2[4]–P2[6] (P2[4] = V _{DD} /2, P2[6] = 0.5 V)	P2[4] – P2[6] – 0.035	P2[4] – P2[6] + 0.006	P2[4] – P2[6] + 0.053	V
	RefPower = high Opamp bias = low	V _{REFHI}	Ref High	P2[4]+P2[6] (P2[4] = V _{DD} /2, P2[6] = 0.5 V)	P2[4] + P2[6] – 0.094	P2[4] + P2[6] – 0.005	P2[4] + P2[6] + 0.073	V
		V _{AGND}	AGND	P2[4]	P2[4]	P2[4]	P2[4]	–
		V _{REFLO}	Ref Low	P2[4]–P2[6] (P2[4] = V _{DD} /2, P2[6] = 0.5 V)	P2[4] – P2[6] – 0.033	P2[4] – P2[6] + 0.002	P2[4] – P2[6] + 0.042	V
	RefPower = medium Opamp bias = high	V _{REFHI}	Ref High	P2[4]+P2[6] (P2[4] = V _{DD} /2, P2[6] = 0.5 V)	P2[4] + P2[6] – 0.094	P2[4] + P2[6] – 0.003	P2[4] + P2[6] + 0.075	V
		V _{AGND}	AGND	P2[4]	P2[4]	P2[4]	P2[4]	–
		V _{REFLO}	Ref Low	P2[4]–P2[6] (P2[4] = V _{DD} /2, P2[6] = 0.5 V)	P2[4] – P2[6] – 0.035	P2[4] – P2[6]	P2[4] – P2[6] + 0.038	V
	RefPower = medium Opamp bias = low	V _{REFHI}	Ref High	P2[4]+P2[6] (P2[4] = V _{DD} /2, P2[6] = 0.5 V)	P2[4] + P2[6] – 0.095	P2[4] + P2[6] – 0.003	P2[4] + P2[6] + 0.080	V
		V _{AGND}	AGND	P2[4]	P2[4]	P2[4]	P2[4]	–
		V _{REFLO}	Ref Low	P2[4]–P2[6] (P2[4] = V _{DD} /2, P2[6] = 0.5 V)	P2[4] – P2[6] – 0.038	P2[4] – P2[6]	P2[4] – P2[6] + 0.038	V

Table 20. 3.3-V DC Analog Reference Specifications (continued)

Reference ARF_CR [5:3]	Reference Power Settings	Symbol	Reference	Description	Min	Typ	Max	Units
0b010	RefPower = high Opamp bias = high	V _{REFHI}	Ref High	V _{DD}	V _{DD} - 0.119	V _{DD} - 0.005	V _{DD}	V
		V _{AGND}	AGND	V _{DD} /2	V _{DD} /2 - 0.028	V _{DD} /2	V _{DD} /2 + 0.029	V
		V _{REFLO}	Ref Low	V _{SS}	V _{SS}	V _{SS} + 0.004	V _{SS} + 0.022	V
	RefPower = high Opamp bias = low	V _{REFHI}	Ref High	V _{DD}	V _{DD} - 0.131	V _{DD} - 0.004	V _{DD}	V
		V _{AGND}	AGND	V _{DD} /2	V _{DD} /2 - 0.028	V _{DD} /2	V _{DD} /2 + 0.028	V
		V _{REFLO}	Ref Low	V _{SS}	V _{SS}	V _{SS} + 0.003	V _{SS} + 0.021	V
	RefPower = medium Opamp bias = high	V _{REFHI}	Ref High	V _{DD}	V _{DD} - 0.111	V _{DD} - 0.003	V _{DD}	V
		V _{AGND}	AGND	V _{DD} /2	V _{DD} /2 - 0.029	V _{DD} /2	V _{DD} /2 + 0.028	V
		V _{REFLO}	Ref Low	V _{SS}	V _{SS}	V _{SS} + 0.002	V _{SS} + 0.017	V
	RefPower = medium Opamp bias = low	V _{REFHI}	Ref High	V _{DD}	V _{DD} - 0.128	V _{DD} - 0.003	V _{DD}	V
		V _{AGND}	AGND	V _{DD} /2	V _{DD} /2 - 0.029	V _{DD} /2	V _{DD} /2 + 0.029	V
		V _{REFLO}	Ref Low	V _{SS}	V _{SS}	V _{SS} + 0.002	V _{SS} + 0.019	V
0b011	All power settings. Not allowed for 3.3 V.	-	-	-	-	-	-	-
0b100	All power settings. Not allowed for 3.3 V.	-	-	-	-	-	-	-
0b101	RefPower = high Opamp bias = high	V _{REFHI}	Ref High	P2[4] + Bandgap (P2[4] = V _{DD} /2)	P2[4] + 1.214	P2[4] + 1.291	P2[4] + 1.359	V
		V _{AGND}	AGND	P2[4]	P2[4]	P2[4]	P2[4]	-
		V _{REFLO}	Ref Low	P2[4] - Bandgap (P2[4] = V _{DD} /2)	P2[4] - 1.335	P2[4] - 1.292	P2[4] - 1.200	V
	RefPower = high Opamp bias = low	V _{REFHI}	Ref High	P2[4] + Bandgap (P2[4] = V _{DD} /2)	P2[4] + 1.219	P2[4] + 1.293	P2[4] + 1.357	V
		V _{AGND}	AGND	P2[4]	P2[4]	P2[4]	P2[4]	-
		V _{REFLO}	Ref Low	P2[4] - Bandgap (P2[4] = V _{DD} /2)	P2[4] - 1.335	P2[4] - 1.295	P2[4] - 1.243	V
	RefPower = medium Opamp bias = high	V _{REFHI}	Ref High	P2[4] + Bandgap (P2[4] = V _{DD} /2)	P2[4] + 1.222	P2[4] + 1.294	P2[4] + 1.356	V
		V _{AGND}	AGND	P2[4]	P2[4]	P2[4]	P2[4]	-
		V _{REFLO}	Ref Low	P2[4] - Bandgap (P2[4] = V _{DD} /2)	P2[4] - 1.337	P2[4] - 1.296	P2[4] - 1.244	V
	RefPower = medium Opamp bias = low	V _{REFHI}	Ref High	P2[4] + Bandgap (P2[4] = V _{DD} /2)	P2[4] + 1.224	P2[4] + 1.295	P2[4] + 1.355	V
		V _{AGND}	AGND	P2[4]	P2[4]	P2[4]	P2[4]	-
		V _{REFLO}	Ref Low	P2[4] - Bandgap (P2[4] = V _{DD} /2)	P2[4] - 1.339	P2[4] - 1.297	P2[4] - 1.244	V

Table 20. 3.3-V DC Analog Reference Specifications (continued)

Reference ARF_CR [5:3]	Reference Power Settings	Symbol	Reference	Description	Min	Typ	Max	Units
0b110	RefPower = high Opamp bias = high	V _{REFHI}	Ref High	2 × Bandgap	2.510	2.595	2.655	V
		V _{AGND}	AGND	Bandgap	1.276	1.301	1.332	V
		V _{REFLO}	Ref Low	V _{SS}	V _{SS}	V _{SS} + 0.006	V _{SS} + 0.031	V
	RefPower = high Opamp bias = low	V _{REFHI}	Ref High	2 × Bandgap	2.513	2.594	2.656	V
		V _{AGND}	AGND	Bandgap	1.275	1.301	1.331	V
		V _{REFLO}	Ref Low	V _{SS}	V _{SS}	V _{SS} + 0.004	V _{SS} + 0.021	V
	RefPower = medium Opamp bias = high	V _{REFHI}	Ref High	2 × Bandgap	2.516	2.595	2.657	V
		V _{AGND}	AGND	Bandgap	1.275	1.301	1.331	V
		V _{REFLO}	Ref Low	V _{SS}	V _{SS}	V _{SS} + 0.003	V _{SS} + 0.017	V
	RefPower = medium Opamp bias = low	V _{REFHI}	Ref High	2 × Bandgap	2.520	2.595	2.658	V
		V _{AGND}	AGND	Bandgap	1.275	1.300	1.331	V
		V _{REFLO}	Ref Low	V _{SS}	V _{SS}	V _{SS} + 0.002	V _{SS} + 0.015	V
0b111	All power settings. Not allowed for 3.3 V.	–	–	–	–	–	–	

11.3.8 DC Analog PSoC Block Specifications

The following table lists guaranteed maximum and minimum specifications for the voltage and temperature ranges: 4.75 V to 5.25 V and $-40\text{ }^{\circ}\text{C} \leq T_A \leq 85\text{ }^{\circ}\text{C}$, or 3.0 V to 3.6 V and $-40\text{ }^{\circ}\text{C} \leq T_A \leq 85\text{ }^{\circ}\text{C}$, respectively. Typical parameters are measured at 5 V and 3.3 V at 25 °C and are for design guidance only.

Table 21. DC Analog PSoC Block Specifications

Symbol	Description	Min	Typ	Max	Units	Notes
R _{CT}	Resistor unit value (continuous time)	–	12.2	–	kΩ	
C _{SC}	Capacitor unit value (switched capacitor)	–	80	–	fF	

11.3.9 DC POR and LVD Specifications

The following table lists guaranteed maximum and minimum specifications for the voltage and temperature ranges: 4.75 V to 5.25 V and $-40\text{ }^{\circ}\text{C} \leq T_A \leq 85\text{ }^{\circ}\text{C}$, or 3.0 V to 3.6 V and $-40\text{ }^{\circ}\text{C} \leq T_A \leq 85\text{ }^{\circ}\text{C}$, respectively. Typical parameters are measured at 5 V or 3.3 V at 25 °C and are for design guidance only.

Note The bits PORLEV and VM in the following table refer to bits in the VLT_CR register. See the *PSoC Technical Reference Manual* for more information on the VLT_CR register.

Table 22. DC POR and LVD Specifications

Symbol	Description	Min	Typ	Max	Units	Notes
V _{PPOR0R} V _{PPOR1R} V _{PPOR2R}	V _{DD} value for PPOR trip (positive ramp) PORLEV[1:0] = 00b PORLEV[1:0] = 01b PORLEV[1:0] = 10b	–	2.91 4.39 4.55	–	V V V	
V _{PPOR0} ^[23] V _{PPOR1} ^[23] V _{PPOR2} ^[23]	V _{DD} value for PPOR trip (negative ramp) PORLEV[1:0] = 00b PORLEV[1:0] = 01b PORLEV[1:0] = 10b	–	2.82 4.39 4.55	–	V V V	
V _{PH0} V _{PH1} V _{PH2}	PPOR hysteresis PORLEV[1:0] = 00b PORLEV[1:0] = 01b PORLEV[1:0] = 10b	– – –	92 0 0	– – –	mV mV mV	
V _{LVD0} V _{LVD1} V _{LVD2} V _{LVD3} V _{LVD4} V _{LVD5} V _{LVD6} V _{LVD7}	V _{DD} value for LVD trip VM[2:0] = 000b VM[2:0] = 001b VM[2:0] = 010b VM[2:0] = 011b VM[2:0] = 100b VM[2:0] = 101b VM[2:0] = 110b VM[2:0] = 111b	2.86 2.96 3.07 3.92 4.39 4.55 4.63 4.72	2.92 3.02 3.13 4.00 4.48 4.64 4.73 4.81	2.98 ^[24] 3.08 3.20 4.08 4.57 4.74 ^[25] 4.82 4.91	V V V V V V V V	

Notes

23. Errata: When V_{DD} of the device is pulled below ground just before power on, the first read from each 8K Flash page may be corrupted. This issue does not affect Flash page 0 because it is the selected page upon reset. More details in “[Errata](#)” on page 66.

24. Always greater than 50 mV above PPOR (PORLEV = 00) for falling supply.

25. Always greater than 50 mV above PPOR (PORLEV = 10) for falling supply.

11.3.10 DC Programming Specifications

The following table lists guaranteed maximum and minimum specifications for the voltage and temperature ranges: 4.75 V to 5.25 V and $-40\text{ }^{\circ}\text{C} \leq T_A \leq 85\text{ }^{\circ}\text{C}$, or 3.0 V to 3.6 V and $-40\text{ }^{\circ}\text{C} \leq T_A \leq 85\text{ }^{\circ}\text{C}$, respectively. Typical parameters are measured at 5 V and 3.3 V at 25 °C and are for design guidance only.

Table 23. DC Programming Specifications

Symbol	Description	Min	Typ	Max	Units	Notes
V _{DDP}	V _{DD} for programming and erase	4.5	5	5.5	V	This specification applies to the functional requirements of external programmer tools
V _{DDL}	Low V _{DD} for verify	3	3.1	3.2	V	This specification applies to the functional requirements of external programmer tools
V _{DDH}	High V _{DD} for verify	5.1	5.2	5.3	V	This specification applies to the functional requirements of external programmer tools
V _{DDIWRITE}	Supply voltage for flash write operation	3		5.25	V	This specification applies to this device when it is executing internal flash writes
I _{DDP}	Supply current during programming or verify	–	15	30	mA	
V _{ILP}	Input low voltage during programming or verify	–	–	0.8	V	
V _{IHP}	Input high voltage during programming or verify	2.1	–	–	V	
I _{ILP}	Input current when applying V _{ILP} to P1[0] or P1[1] during programming or verify	–	–	0.2	mA	Driving internal pull-down resistor.
I _{IHP}	Input current when applying V _{IHP} to P1[0] or P1[1] during programming or verify	–	–	1.5	mA	Driving internal pull-down resistor.
V _{OLV}	Output low voltage during programming or verify	–	–	V _{SS} + 0.75	V	
V _{OHV}	Output high voltage during programming or verify	V _{DD} – 1.0	–	V _{DD}	V	
Flash _{ENPB}	Flash endurance (per block) ^[26]	50,000	–	–	–	Erase/write cycles per block.
Flash _{ENT}	Flash endurance (total) ^[27]	1,800,000	–	–	–	Erase/write cycles.
Flash _{DR}	Flash data retention	10	–	–	Years	

11.3.11 DC I²C Specifications

The following table lists guaranteed maximum and minimum specifications for the voltage and temperature ranges: 4.75 V to 5.25 V and $-40\text{ }^{\circ}\text{C} \leq T_A \leq 85\text{ }^{\circ}\text{C}$, or 3.0 V to 3.6 V and $-40\text{ }^{\circ}\text{C} \leq T_A \leq 85\text{ }^{\circ}\text{C}$, respectively. Typical parameters are measured at 5 V and 3.3 V at 25 °C and are for design guidance only.

Table 24. DC I²C Specifications^[28]

Symbol	Description	Min	Typ	Max	Units	Notes
V _{ILI2C}	Input low level	–	–	0.3 × V _{DD}	V	3.0 V ≤ V _{DD} ≤ 3.6 V
		–	–	0.25 × V _{DD}	V	4.75 V ≤ V _{DD} ≤ 5.25 V
V _{IHI2C}	Input high level	0.7 × V _{DD}	–	–	V	3.0 V ≤ V _{DD} ≤ 5.25 V

11.4 AC Electrical Characteristics

11.4.1 AC Chip-Level Specifications

The following table lists guaranteed maximum and minimum specifications for the voltage and temperature ranges: 4.75 V to 5.25 V and $-40\text{ }^{\circ}\text{C} \leq T_A \leq 85\text{ }^{\circ}\text{C}$, or 3.0 V to 3.6 V and $-40\text{ }^{\circ}\text{C} \leq T_A \leq 85\text{ }^{\circ}\text{C}$, respectively. Typical parameters are measured at 5 V and 3.3 V at 25 °C and are for design guidance only.

Table 25. AC Chip Level Specifications

Symbol	Description	Min	Typ	Max	Units	Notes
F _{IMO245V}	Internal main oscillator frequency for 24 MHz (5 V)	23.04	24	24.96 ^[29]	MHz	Trimmed for 5 V operation using factory trim values.
F _{IMO243V}	Internal main oscillator frequency for 24 MHz (3.3 V)	22.08	24	25.92 ^[30]	MHz	Trimmed for 3.3 V operation using factory trim values.
F _{IMOUSB5V}	Internal main oscillator frequency with USB (5 V) Frequency locking enabled and USB traffic present.	23.94	24	24.06	MHz	$-10\text{ }^{\circ}\text{C} \leq T_A \leq 85\text{ }^{\circ}\text{C}$ $4.35 \leq V_{DD} \leq 5.15$
F _{IMOUSB3V}	Internal main oscillator frequency with USB (3.3 V) Frequency locking enabled and USB traffic present.	23.94	24	24.06	MHz	$-0\text{ }^{\circ}\text{C} \leq T_A \leq 70\text{ }^{\circ}\text{C}$ $3.15 \leq V_{DD} \leq 3.45$
F _{CPU1}	CPU frequency (5 V nominal)	0.093	24	24.96 ^[29]	MHz	SLIMO Mode = 0.
F _{CPU2}	CPU frequency (3.3 V nominal)	0.086	12	12.96 ^[30]	MHz	SLIMO Mode = 0.
F _{BLK5}	Digital PSoC block frequency (5 V nominal)	0	48	49.92 ^[29,31]	MHz	Refer to the AC digital block Specifications.
F _{BLK3}	Digital PSoC block frequency (3.3 V nominal)	0	24	25.92 ^[31]	MHz	
F _{32K1}	Internal low speed oscillator frequency	15	32	64	kHz	
F _{32K_U}	Internal low speed oscillator untrimmed frequency	5	–	100	kHz	After a reset and before the M8C starts to run, the ILO is not trimmed. See the System Resets section of the PSoC Technical Reference Manual for details on this timing
t _{XRST}	External reset pulse width	10	–	–	μs	
DC _{24M}	24 MHz duty cycle	40	50	60	%	
DC _{ILO}	Internal low speed oscillator duty cycle	20	50	80	%	
Step _{24M}	24 MHz trim step size	–	50	–	kHz	
F _{out48M}	48 MHz output frequency	46.08	48.0	49.92 ^[29,30]	MHz	Trimmed. Utilizing factory trim values.
F _{MAX}	Maximum frequency of signal on row input or row output.	–	–	12.96	MHz	
SR _{POWER_UP}	Power supply slew rate	–	–	250	V/ms	V _{DD} slew rate during power-up.

Notes

26. The 50,000 cycle flash endurance per block is only guaranteed if the flash is operating within one voltage range. Voltage ranges are 3.0 V to 3.6 V and 4.75 V to 5.25 V.
27. A maximum of $36 \times 50,000$ block endurance cycles is allowed. This may be balanced between operations on 36×1 blocks of 50,000 maximum cycles each, 36×2 blocks of 25,000 maximum cycles each, or 36×4 blocks of 12,500 maximum cycles each (to limit the total number of cycles to $36 \times 50,000$ and ensure that no single block ever sees more than 50,000 cycles).
- For the full industrial range, the user must employ a temperature sensor user module (FlashTemp) and feed the result to the temperature argument before writing. See the Flash APIs application note [Design Aids – Reading and Writing PSoC® Flash – AN2015](#) for more information.
28. All GPIOs meet the DC GPIO V_{IL} and V_{IH} specifications found in the DC GPIO Specifications sections. The I²C GPIO pins also meet the mentioned specifications.

Table 25. AC Chip Level Specifications (continued)

Symbol	Description	Min	Typ	Max	Units	Notes
t_{POWERUP}	Time from end of POR to CPU executing code	–	16	100	ms	Power-up from 0 V. See the System Resets section of the PSoC Technical Reference Manual.
$t_{\text{jit_IMO}}^{[32]}$	24 MHz IMO cycle-to-cycle jitter (RMS)	–	200	1200	ps	
	24 MHz IMO long term N cycle-to-cycle jitter (RMS)	–	900	6000	ps	N=32
	24 MHz IMO period jitter (RMS)	–	200	900	ps	

11.4.2 AC GPIO Specifications

The following table lists guaranteed maximum and minimum specifications for the voltage and temperature ranges: 4.75 V to 5.25 V and $-40\text{ }^{\circ}\text{C} \leq T_A \leq 85\text{ }^{\circ}\text{C}$, or 3.0 V to 3.6 V and $-40\text{ }^{\circ}\text{C} \leq T_A \leq 85\text{ }^{\circ}\text{C}$, respectively. Typical parameters are measured at 5 V and 3.3 V at 25 °C and are for design guidance only.

Table 26. AC GPIO Specifications

Symbol	Description	Min	Typ	Max	Units	Notes
F_{GPIO}	GPIO operating frequency	0	–	12	MHz	Normal strong mode
t_{RiseF}	Rise time, normal strong mode, $C_{\text{load}} = 50\text{ pF}$	3	–	18	ns	$V_{\text{DD}} = 4.5\text{ to }5.25\text{ V}$, 10% to 90%
t_{FallF}	Fall time, normal strong mode, $C_{\text{load}} = 50\text{ pF}$	2	–	18	ns	$V_{\text{DD}} = 4.5\text{ to }5.25\text{ V}$, 10% to 90%
t_{RiseS}	Rise time, slow strong mode, $C_{\text{load}} = 50\text{ pF}$	10	27	–	ns	$V_{\text{DD}} = 3\text{ to }5.25\text{ V}$, 10% to 90%
t_{FallS}	Fall time, slow strong mode, $C_{\text{load}} = 50\text{ pF}$	10	22	–	ns	$V_{\text{DD}} = 3\text{ to }5.25\text{ V}$, 10% to 90%

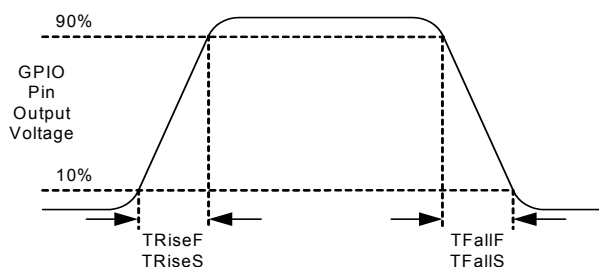
Figure 12. GPIO Timing Diagram

Notes

29. $4.75\text{ V} < V_{\text{DD}} < 5.25\text{ V}$.

30. $3.0\text{ V} < V_{\text{DD}} < 3.6\text{ V}$. See application note [Adjusting PSoC® Trims for 3.3 V and 2.7 V Operation – AN2012](#) for information on trimming for operation at 3.3 V.

31. See the individual user module datasheets for information on maximum frequencies for user modules.

32. Refer to Cypress Jitter Specifications application note, [Understanding Datasheet Jitter Specifications for Cypress Timing Products – AN5054](#) for more information.

11.4.3 AC Full Speed USB Specifications

The following table lists guaranteed maximum and minimum specifications for the voltage and temperature ranges: 4.75 V to 5.25 V and $-10\text{ }^{\circ}\text{C} \leq T_A \leq 85\text{ }^{\circ}\text{C}$, or 3.0 V to 3.6 V and $-10\text{ }^{\circ}\text{C} \leq T_A \leq 85\text{ }^{\circ}\text{C}$, respectively. Typical parameters are measured at 5 V and 3.3 V at 25 °C and are for design guidance only.

Table 27. AC Full Speed (12 Mbps) USB Specifications

Symbol	Description	Min	Typ	Max	Units	Notes
t_{RFS}	Transition rise time	4	–	20	ns	For 50 pF load
t_{FSS}	Transition fall time	4	–	20	ns	For 50 pF load
t_{RFMFS}	Rise/fall time matching: (t_R/t_F)	90	–	111	%	For 50 pF load
$t_{DRATEFS}$	Full speed data rate	12 – 0.25%	12	12 + 0.25%	Mbps	

11.4.4 AC Operational Amplifier Specifications

The following tables list guaranteed maximum and minimum specifications for the voltage and temperature ranges: 4.75 V to 5.25 V and $-40\text{ }^{\circ}\text{C} \leq T_A \leq 85\text{ }^{\circ}\text{C}$, or 3.0 V to 3.6 V and $-40\text{ }^{\circ}\text{C} \leq T_A \leq 85\text{ }^{\circ}\text{C}$, respectively. Typical parameters are measured at 5 V and 3.3 V at 25 °C and are for design guidance only.

Settling times, slew rates, and gain bandwidth are based on the analog continuous time PSoC block.

Power = high and Opamp bias = high is not supported at 3.3 V.

Table 28. 5-V AC Operational Amplifier Specifications

Symbol	Description	Min	Typ	Max	Units
t_{ROA}	Rising settling time from 80% of ΔV to 0.1% of ΔV (10 pF load, unity gain)				
	Power = low, Opamp bias = low	–	–	3.9	μs
	Power = medium, Opamp bias = high	–	–	0.72	μs
t_{SOA}	Falling settling time from 20% of ΔV to 0.1% of ΔV (10 pF load, unity gain)				
	Power = low, Opamp bias = low	–	–	5.9	μs
	Power = medium, Opamp bias = high	–	–	0.92	μs
SR_{ROA}	Rising slew rate (20% to 80%)(10 pF load, unity gain)				
	Power = low, Opamp bias = low	0.15	–	–	V/ μs
	Power = medium, Opamp bias = high	1.7	–	–	V/ μs
SR_{FOA}	Falling slew rate (20% to 80%)(10 pF load, unity gain)				
	Power = low, Opamp bias = low	0.01	–	–	V/ μs
	Power = medium, Opamp bias = high	0.5	–	–	V/ μs
BW_{OA}	Gain bandwidth product				
	Power = low, Opamp bias = low	0.75	–	–	MHz
	Power = medium, Opamp bias = high	3.1	–	–	MHz
E_{NOA}	Noise at 1 kHz (Power = medium, Opamp bias = high)				
		–	100	–	nV/rt-Hz

Table 29. 3.3-V AC Operational Amplifier Specifications

Symbol	Description	Min	Typ	Max	Units
t_{ROA}	Rising settling time from 80% of ΔV to 0.1% of ΔV (10 pF load, unity gain)				
	Power = low, Opamp bias = low	–	–	3.92	μs
t_{SOA}	Falling settling time from 20% of ΔV to 0.1% of ΔV (10 pF load, unity gain)				
	Power = low, Opamp bias = low	–	–	5.41	μs
SR_{ROA}	Rising slew rate (20% to 80%)(10 pF load, unity gain)				
	Power = low, Opamp bias = low	0.31	–	–	V/ μs
SR_{FOA}	Falling slew rate (20% to 80%)(10 pF load, Unity Gain)				
	Power = low, Opamp bias = low	0.24	–	–	V/ μs
BW_{OA}	Gain bandwidth product				
	Power = low, Opamp bias = low	0.67	–	–	MHz
E_{NOA}	Noise at 1 kHz (Power = medium, Opamp bias = high)				
		–	100	–	nV/rt-Hz

When bypassed by a capacitor on P2[4], the noise of the analog ground signal distributed to each block is reduced by a factor of up to 5 (14 dB). This is at frequencies above the corner frequency defined by the on-chip 8.1 K resistance and the external capacitor.

Figure 13. Typical AGND Noise with P2[4] Bypass

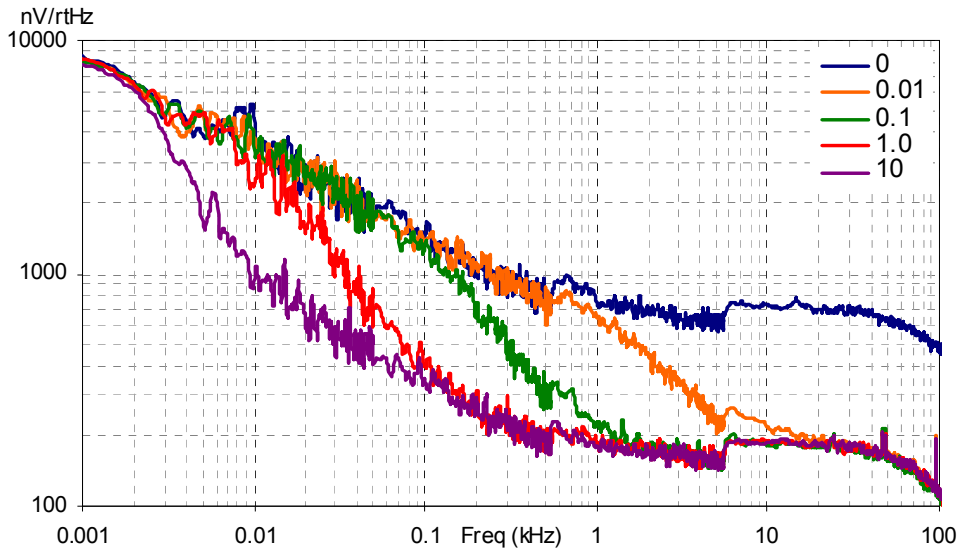

At low frequencies, the opamp noise is proportional to $1/f$, power independent, and determined by device geometry. At high frequencies, increased power level reduces the noise spectrum level.

Figure 14. Typical Opamp Noise

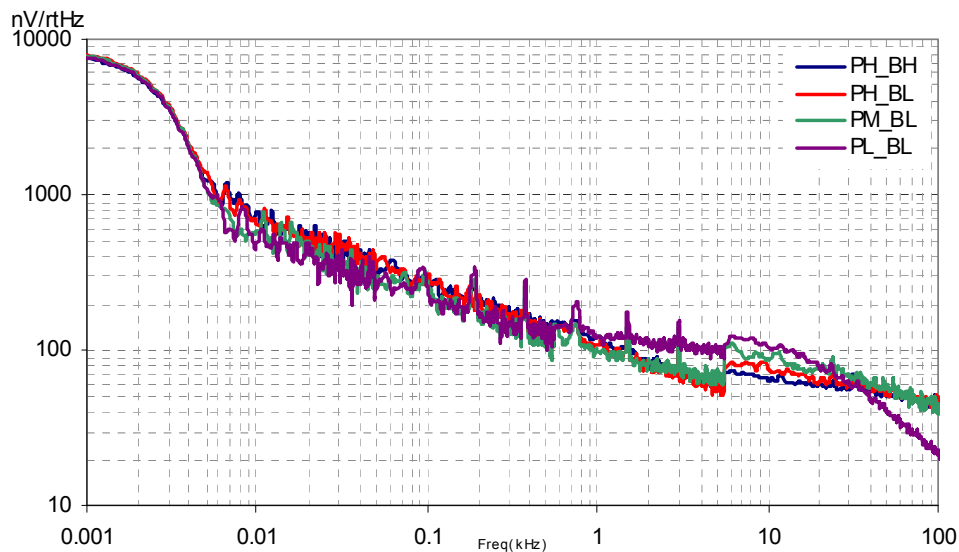

11.4.5 AC Low Power Comparator Specifications

The following table lists guaranteed maximum and minimum specifications for the voltage and temperature ranges: 4.75 V to 5.25 V and $-40\text{ }^{\circ}\text{C} \leq T_A \leq 85\text{ }^{\circ}\text{C}$ or 3.0 V to 3.6 V and $-40\text{ }^{\circ}\text{C} \leq T_A \leq 85\text{ }^{\circ}\text{C}$, respectively. Typical parameters are measured at 5 V at 25 °C and are for design guidance only.

Table 30. AC Low Power Comparator Specifications

Symbol	Description	Min	Typ	Max	Units	Notes
t_{RLPC}	LPC response time	–	–	50	μs	$\geq 50\text{ mV}$ overdrive comparator reference set within V_{REFLPC} .

11.4.6 AC Digital Block Specifications

The following table lists guaranteed maximum and minimum specifications for the voltage and temperature ranges: 4.75 V to 5.25 V and $-40\text{ }^{\circ}\text{C} \leq T_A \leq 85\text{ }^{\circ}\text{C}$, or 3.0 V to 3.6 V and $-40\text{ }^{\circ}\text{C} \leq T_A \leq 85\text{ }^{\circ}\text{C}$, respectively. Typical parameters apply to 5 V and 3.3 V at 25 °C and are for design guidance only.

Table 31. AC Digital Block Specifications

Function	Description	Min	Typ	Max	Unit	Notes
All functions	Block input clock frequency					
	$V_{DD} \geq 4.75\text{ V}$	–	–	49.9 2	MHz	
	$V_{DD} < 4.75\text{ V}$	–	–	25.9 2	MHz	
Timer	Input clock frequency					
	No capture, $V_{DD} \geq 4.75\text{ V}$	–	–	49.9 2	MHz	
	No capture, $V_{DD} < 4.75\text{ V}$	–	–	25.9 2	MHz	
	With capture	–	–	25.9 2	MHz	
	Capture pulse width	50 ^[33]	–	–	ns	
Counter	Input clock frequency					
	No enable input, $V_{DD} \geq 4.75\text{ V}$	–	–	49.9 2	MHz	
	No enable input, $V_{DD} < 4.75\text{ V}$	–	–	25.9 2	MHz	
	With enable input	–	–	25.9 2	MHz	
	Enable input pulse width	50 ^[33]	–	–	ns	
	Kill pulse width					
	Asynchronous restart mode	20	–	–	ns	
	Synchronous restart mode	50 ^[33]	–	–	ns	
	Disable mode	50 ^[33]	–	–	ns	
	Input clock frequency					
	$V_{DD} \geq 4.75\text{ V}$	–	–	49.9 2	MHz	
	$V_{DD} < 4.75\text{ V}$	–	–	25.9 2	MHz	

Note

33. 50 ns minimum input pulse width is based on the input synchronizers running at 24 MHz (42 ns nominal period).

Table 31. AC Digital Block Specifications (continued)

Function	Description	Min	Typ	Max	Unit	Notes
CRCPRS (PRS Mode)	Input clock frequency					
	$V_{DD} \geq 4.75$ V	–	–	49.9 2	MHz	
	$V_{DD} < 4.75$ V	–	–	25.9 2	MHz	
CRCPRS (CRC Mode)	Input clock frequency	–	–	24.6	MHz	
SPIM	Input clock frequency	–	–	8.2	MHz	The SPI serial clock (SCLK) frequency is equal to the input clock frequency divided by 2.
SPIS	Input clock (SCLK) frequency	–	–	4.1	MHz	The input clock is the SPI SCLK in SPIS mode.
	Width of SS_negated between transmissions	50 ^[33]	–	–	ns	
Transmitter	Input clock frequency					The baud rate is equal to the input clock frequency divided by 8.
	$V_{DD} \geq 4.75$ V, 2 stop bits	–	–	49.9 2	MHz	
	$V_{DD} \geq 4.75$ V, 1 stop bit	–	–	24.6	MHz	
	$V_{DD} < 4.75$ V	–	–	24.6	MHz	
Receiver	Input clock frequency					The baud rate is equal to the input clock frequency divided by 8.
	$V_{DD} \geq 4.75$ V, 2 stop bits	–	–	49.9 2	MHz	
	$V_{DD} \geq 4.75$ V, 1 stop bit	–	–	24.6	MHz	
	$V_{DD} < 4.75$ V	–	–	24.6	MHz	

11.4.7 AC External Clock Specifications

The following tables list guaranteed maximum and minimum specifications for the voltage and temperature ranges: 4.75 V to 5.25 V and $-40\text{ }^{\circ}\text{C} \leq T_A \leq 85\text{ }^{\circ}\text{C}$, or 3.0 V to 3.6 V and $-40\text{ }^{\circ}\text{C} \leq T_A \leq 85\text{ }^{\circ}\text{C}$, respectively. Typical parameters are measured at 5 V and 3.3 V at 25 °C and are for design guidance only.

Table 32. AC External Clock Specifications

Symbol	Description	Min	Typ	Max	Units	Notes
F_{OSCEXT}	Frequency for USB applications	23.94	24	24.06	MHz	
–	Duty cycle	47	50	53	%	
–	Power-up to IMO switch	150	–	–	μs	

11.4.8 AC Analog Output Buffer Specifications

The following tables list guaranteed maximum and minimum specifications for the voltage and temperature ranges: 4.75 V to 5.25 V and $-40\text{ }^{\circ}\text{C} \leq T_A \leq 85\text{ }^{\circ}\text{C}$, or 3.0 V to 3.6 V and $-40\text{ }^{\circ}\text{C} \leq T_A \leq 85\text{ }^{\circ}\text{C}$, respectively. Typical parameters are measured at 5 V and 3.3 V at 25 $^{\circ}\text{C}$ and are for design guidance only.

Table 33. 5-V AC Analog Output Buffer Specifications

Symbol	Description	Min	Typ	Max	Units	Notes
t_{ROB}	Rising settling time to 0.1%, 1 V Step, 100 pF load	–	–	2.5	μs	
	Power = low	–	–	2.5	μs	
t_{SOB}	Falling settling time to 0.1%, 1 V Step, 100 pF load	–	–	2.2	μs	
	Power = high	–	–	2.2	μs	
SR_{ROB}	Rising slew rate (20% to 80%), 1 V Step, 100 pF load	0.65	–	–	V/ μs	
	Power = low	0.65	–	–	V/ μs	
SR_{FOB}	Falling slew rate (80% to 20%), 1 V Step, 100 pF load	0.65	–	–	V/ μs	
	Power = high	0.65	–	–	V/ μs	
BW_{OBSS}	Small signal bandwidth, 20 mV _{pp} , 3 dB BW, 100 pF load	0.8	–	–	MHz	
	Power = high	0.8	–	–	MHz	
BW_{OBSL}	Large signal bandwidth, 1 V _{pp} , 3 dB BW, 100 pF load	300	–	–	kHz	
	Power = high	300	–	–	kHz	

Table 34. 3.3-V AC Analog Output Buffer Specifications

Symbol	Description	Min	Typ	Max	Units	Notes
t_{ROB}	Rising settling time to 0.1%, 1 V Step, 100 pF load	–	–	3.8	μs	
	Power = high	–	–	3.8	μs	
t_{SOB}	Falling settling time to 0.1%, 1 V Step, 100 pF load	–	–	2.6	μs	
	Power = high	–	–	2.6	μs	
SR_{ROB}	Rising slew rate (20% to 80%), 1 V Step, 100 pF load	0.5	–	–	V/ μs	
	Power = high	0.5	–	–	V/ μs	
SR_{FOB}	Falling slew rate (80% to 20%), 1 V Step, 100 pF load	0.5	–	–	V/ μs	
	Power = high	0.5	–	–	V/ μs	
BW_{OBSS}	Small signal bandwidth, 20 mV _{pp} , 3dB BW, 100 pF load	0.7	–	–	MHz	
	Power = high	0.7	–	–	MHz	
BW_{OBSL}	Large signal bandwidth, 1 V _{pp} , 3dB BW, 100 pF load	200	–	–	kHz	
	Power = high	200	–	–	kHz	

11.4.9 AC Programming Specifications

The following table lists guaranteed maximum and minimum specifications for the voltage and temperature ranges: 4.75 V to 5.25 V and $-40\text{ }^{\circ}\text{C} \leq T_A \leq 85\text{ }^{\circ}\text{C}$, or 3.0 V to 3.6 V and $-40\text{ }^{\circ}\text{C} \leq T_A \leq 85\text{ }^{\circ}\text{C}$, respectively. Typical parameters are measured at 5 V and 3.3 V at 25 °C and are for design guidance only.

Table 35. AC Programming Specifications

Symbol	Description	Min	Typ	Max	Units	Notes
t_{RSCLK}	Rise time of SCLK	1	–	20	ns	
t_{FSCLK}	Fall time of SCLK	1	–	20	ns	
t_{SSCLK}	Data setup time to falling edge of SCLK	40	–	–	ns	
t_{HSCLK}	Data hold time from falling edge of SCLK	40	–	–	ns	
F_{SCLK}	Frequency of SCLK	0	–	8	MHz	
t_{ERASEB}	Flash erase time (block)	–	10	–	ms	
t_{WRITE}	Flash block write time	–	40	–	ms	
t_{DSCLK}	Data out delay from falling edge of SCLK	–	–	45	ns	$V_{DD} > 3.6$
t_{DSCLK3}	Data out delay from falling edge of SCLK	–	–	50	ns	$3.0 \leq V_{DD} \leq 3.6$
$t_{ERASEALL}$	Flash erase time (bulk)	–	40	–	ms	Erase all blocks and protection fields at once
$t_{PROGRAM_HOT}$	Flash block erase + flash block write time	–	–	100 ^[34]	ms	$0\text{ }^{\circ}\text{C} \leq T_j \leq 100\text{ }^{\circ}\text{C}$
$t_{PROGRAM_COLD}$	Flash block erase + flash block write time	–	–	200 ^[34]	ms	$-40\text{ }^{\circ}\text{C} \leq T_j \leq 0\text{ }^{\circ}\text{C}$

Note

34. For the full industrial range, the user must employ a temperature sensor user module (FlashTemp) and feed the result to the temperature argument before writing. See the Flash APIs application note [Design Aids – Reading and Writing PSoC® Flash – AN2015](#) for more information.

11.4.10 AC I²C Specifications

The following table lists guaranteed maximum and minimum specifications for the voltage and temperature ranges: 4.75 V to 5.25 V and $-40\text{ }^{\circ}\text{C} \leq T_A \leq 85\text{ }^{\circ}\text{C}$, or 3.0 V to 3.6 V and $-40\text{ }^{\circ}\text{C} \leq T_A \leq 85\text{ }^{\circ}\text{C}$, respectively. Typical parameters are measured at 5 V and 3.3 V at 25 °C and are for design guidance only.

Table 36. AC Characteristics of the I²C SDA and SCL Pins for V_{DD}

Symbol	Description	Standard Mode		Fast Mode		Units	Notes
		Min	Max	Min	Max		
F _{SCL I2C}	SCL clock frequency	0	100	0	400	kHz	
t _{HDSTAI2C}	Hold time (repeated) start condition. After this period, the first clock pulse is generated	4.0	–	0.6	–	μs	
t _{LOWI2C}	Low period of the SCL clock	4.7	–	1.3	–	μs	
t _{HIGHI2C}	High period of the SCL clock	4.0	–	0.6	–	μs	
t _{SUSTAI2C}	Setup time for a repeated start condition	4.7	–	0.6	–	μs	
t _{HDDATI2C}	Data hold time	0	–	0	–	μs	
t _{SUDATI2C}	Data setup time	250	–	100 ^[35]	–	ns	
t _{SUSTOI2C}	Setup time for stop condition	4.0	–	0.6	–	μs	
t _{BUFI2C}	Bus free time between a stop and start condition	4.7	–	1.3	–	μs	
t _{SPI2C}	Pulse width of spikes suppressed by the input filter	–	–	0	50	ns	

Figure 15. Definition for Timing for Fast/Standard Mode on the I²C Bus

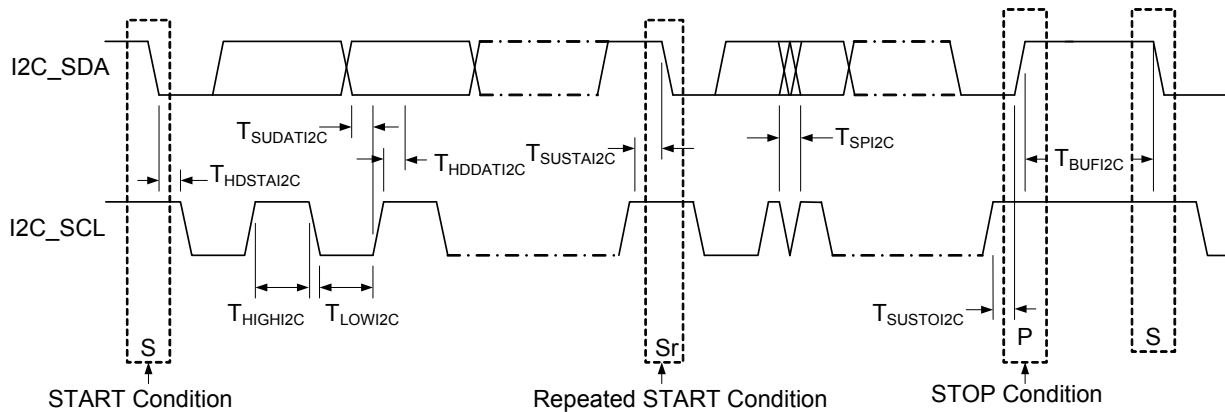

Note

35. A fast-mode I²C-bus device can be used in a standard-mode I²C-bus system, but the requirement $t_{SU,DAT} \geq 250\text{ ns}$ it must meet. This automatically is the case if the device does not stretch the LOW period of the SCL signal. If the device does stretch the LOW period of the SCL signal, it must output the next data bit to the SDA line $t_{rmax} + t_{SU,DAT} = 1000 + 250 = 1250\text{ ns}$ (according to the Standard-Mode I²C-bus specification) before the SCL line is released.

11.5 Thermal Impedance

Table 37. Thermal Impedances per Package

Package	Typical θ_{JA} [36]
56-Pin QFN ^[37]	12.93 °C/W
68-Pin QFN ^[37]	13.05 °C/W
100-Ball VFBGA	65 °C/W
100-Pin TQFP	51 °C/W

11.6 Solder Reflow Peak Specifications

Table 38 shows the solder reflow temperature limits that must not be exceeded.

Table 38. Solder Reflow Specifications

Package	Maximum Peak Temperature (T_C)	Maximum Time above $T_C - 5$ °C
56-Pin QFN	260 °C	30 seconds
68-Pin QFN	260 °C	30 seconds
100-Ball VFBGA	260 °C	30 seconds
100-Pin TQFP	260 °C	30 seconds

Notes

36. $T_J = T_A + \text{POWER} \times \theta_{JA}$.

37. To achieve the thermal impedance specified for the QFN package, see the *Application Notes for Surface Mount Assembly of Amkor's MicroLeadFrame (MLF) Packages* available at <http://www.amkor.com>.

12. Development Tool Selection

12.1 Software

12.1.1 PSoC Designer

At the core of the PSoC development software suite is PSoC Designer, used to generate PSoC firmware applications. PSoC Designer is available free of charge at <http://www.cypress.com> and includes a free C compiler.

12.1.2 PSoC Programmer

Flexible enough to be used on the bench in development, yet suitable for factory programming, PSoC Programmer works either as a standalone programming application or it can operate directly from PSoC Designer. PSoC Programmer software is compatible with both PSoC ICE-Cube in-circuit emulator and PSoC MiniProg. PSoC programmer is available free of charge at <http://www.cypress.com>.

12.2 Development Kits

All development kits can be purchased from the [Cypress Online Store](#).

12.2.1 CY3215-DK Basic Development Kit

The **CY3215-DK** is for prototyping and development with PSoC Designer. This kit supports in-circuit emulation, and the software interface enables you to run, halt, and single step the processor, and view the content of specific memory locations. Advance emulation features are also supported through PSoC Designer. The kit includes:

- PSoC Designer software CD
- ICE-Cube in-circuit Emulator
- ICE Flex-Pod for CY8C29x66 family
- Cat-5 adapter
- MiniEval programming board
- 110 ~ 240 V power supply, Euro-Plug adapter
- iMAGEcraft C compiler (registration required)
- ISSP cable
- USB 2.0 cable and Blue Cat-5 cable
- Two CY8C29466-24PXI 28-PDIP chip samples

12.3 Evaluation Tools

All evaluation tools can be purchased from the [Cypress Online Store](#).

12.3.1 CY3210-MiniProg1

The **CY3210-MiniProg1** kit enables you to program PSoC devices via the MiniProg1 programming unit. The MiniProg is a small, compact prototyping programmer that connects to the PC via a provided USB 2.0 cable. The kit includes:

- MiniProg programming unit
- MiniEval socket programming and evaluation board
- 28-Pin CY8C29466-24PXI PDIP PSoC device sample

- 28-Pin CY8C27443-24PXI PDIP PSoC device sample
- PSoC Designer software CD
- Getting Started guide
- USB 2.0 cable

12.3.2 CY3210-PSoCEval1

The **CY3210-PSoCEval1** kit features an evaluation board and the MiniProg1 programming unit. The evaluation board includes an LCD module, potentiometer, LEDs, and plenty of breadboarding space to meet all of your evaluation needs. The kit includes:

- Evaluation board with LCD module
- MiniProg programming unit
- 28-Pin CY8C29466-24PXI PDIP PSoC device sample (2)
- PSoC Designer software CD
- Getting Started guide
- USB 2.0 cable

12.3.3 CY3214-PSoCEvalUSB

The **CY3214-PSoCEvalUSB** evaluation kit features a development board for the CY8C24794-24LTXI PSoC device. The board supports both USB and capacitive sensing development and debugging support. This evaluation board also includes an LCD module, potentiometer, LEDs, an enunciator and plenty of breadboarding space to meet all of your evaluation needs. The kit includes:

- PSoCEvalUSB board
- LCD module
- MiniProg programming unit
- Mini USB cable
- PSoC Designer and Example Projects CD
- Getting Started guide
- Wire pack

12.4 Device Programmers

All device programmers can be purchased from the [Cypress Online Store](#).

12.4.1 CY3216 Modular Programmer

The **CY3216 Modular Programmer** kit features a modular programmer and the MiniProg1 programming unit. The modular programmer includes three programming module cards and supports multiple Cypress products. The kit includes:

- Modular programmer base
- Three programming module cards
- MiniProg programming unit
- PSoC Designer software CD

- Getting Started guide
- USB 2.0 cable

- CY3207 programmer unit
- PSoC ISSP software CD
- 110 ~ 240 V power supply, Euro-Plug adapter
- USB 2.0 cable

12.4.2 CY3207ISSP In-System Serial Programmer (ISSP)

The **CY3207ISSP** is a production programmer. It includes protection circuitry and an industrial case that is more robust than the MiniProg in a production-programming environment.

Note: CY3207ISSP needs special software and is not compatible with PSoC Programmer. The kit includes:

12.5 Accessories (Emulation and Programming)

Table 39. Emulation and Programming Accessories

Part #	Pin Package	Flex-Pod Kit ^[38]	Foot Kit ^[39]	Adapter ^[40]
CY8C24794-24LQXI	56-pin QFN	CY3250-24X94QFN	None	Adapters can be found at http://www.emulation.com .

Notes

38. Flex-Pod kit includes a practice flex-pod and a practice PCB, in addition to two flex-pods.

39. Foot kit includes surface mount feet that are soldered to the target PCB.

40. Programming adapter converts non-DIP package to DIP footprint. Specific details and ordering information for each of the adapters are found at <http://www.emulation.com>.

13. Ordering Information

Table 40. CY8C24x94 PSoC Device's Key Features and Ordering Information

Package	Package diagram	Ordering Code	Flash (Bytes)	SRAM (Bytes)	Temperature Range	Digital Blocks	Analog Blocks	Digital I/O Pins	Analog Inputs	Analog Outputs	XRES Pin
100-pin OCD TQFP ^[41]	51-85048	CY8C24094-24AXI	16 K	1 K	-40 °C to +85 °C	4	6	56	48	2	Yes
56-pin (7 × 7 mm) QFN	001-58740	CY8C24794-24LQXI	16 K	1 K	-40 °C to +85 °C	4	6	50	48	2	No
56-pin (7 × 7 mm) QFN (Tape and Reel)		CY8C24794-24LQXIT	16 K	1 K	-40 °C to +85 °C	4	6	50	48	2	No
56-pin (8 × 8 mm) QFN (Sawn)	001-53450	CY8C24794-24LTXI	16 K	1 K	-40 °C to +85 °C	4	6	50	48	2	No
56-pin (8 × 8 mm) QFN (Sawn) (Tape and Reel)		CY8C24794-24LTXIT	16 K	1 K	-40 °C to +85 °C	4	6	50	48	2	No
56-pin (8 × 8 mm) QFN (Sawn)	001-53450	CY8C24894-24LTXI	16 K	1 K	-40 °C to +85 °C	4	6	49	47	2	Yes
56-pin (8 × 8 mm) QFN (Sawn) (Tape and Reel)		CY8C24894-24LTXIT	16 K	1 K	-40 °C to +85 °C	4	6	49	47	2	Yes
68-pin (8 × 8 mm) QFN (Sawn)	001-09618	CY8C24994-24LTXI	16 K	1 K	-40 °C to +85 °C	4	6	56	48	2	Yes
68-pin QFN (8 × 8 mm) (Sawn) (Tape and Reel)		CY8C24994-24LTXIT	16 K	1 K	-40 °C to +85 °C	4	6	56	48	2	Yes

Note For die sales information, contact a local Cypress sales office or Field Applications Engineer (FAE).

13.1 Ordering Code Definitions

CY 8 C 24 XXX SP XXT

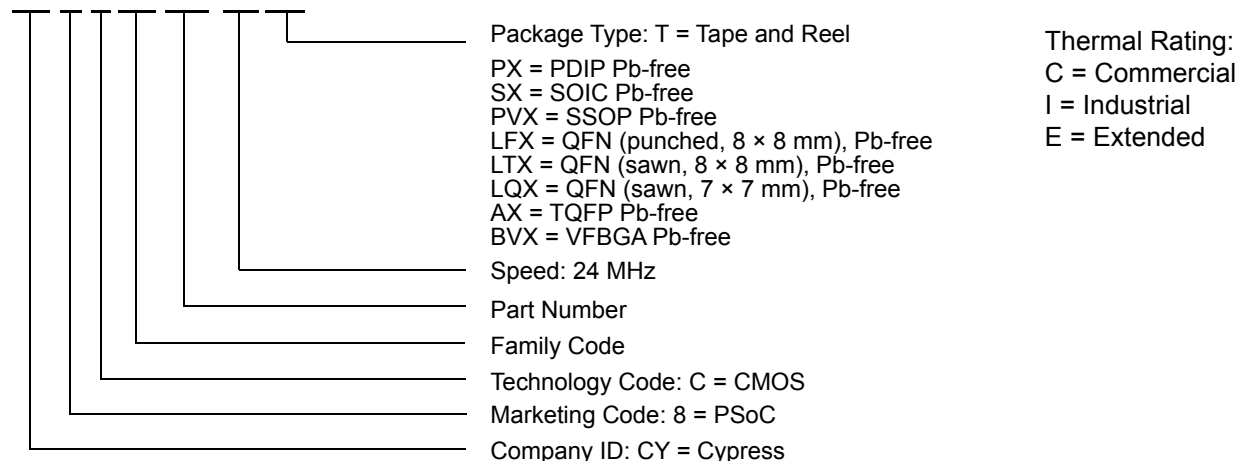

Note
 41. This part may be used for in-circuit debugging. It is NOT available for production.

14. Packaging Dimensions

This section illustrates the package specification for the CY8C24x94 PSoC devices, along with the thermal impedance for the package and solder reflow peak temperatures.

Important Note Emulation tools may require a larger area on the target PCB than the chip's footprint. For a detailed description of the emulation tools' dimensions, refer to the emulator pod dimension drawings at <http://www.cypress.com/design/MR10161>.

Figure 16. 56-pin QFN (7 × 7 × 0.6 mm) LR56A/LQ56A 5.6 × 5.6 E-Pad (Sawn) Package Outline, 001-58740

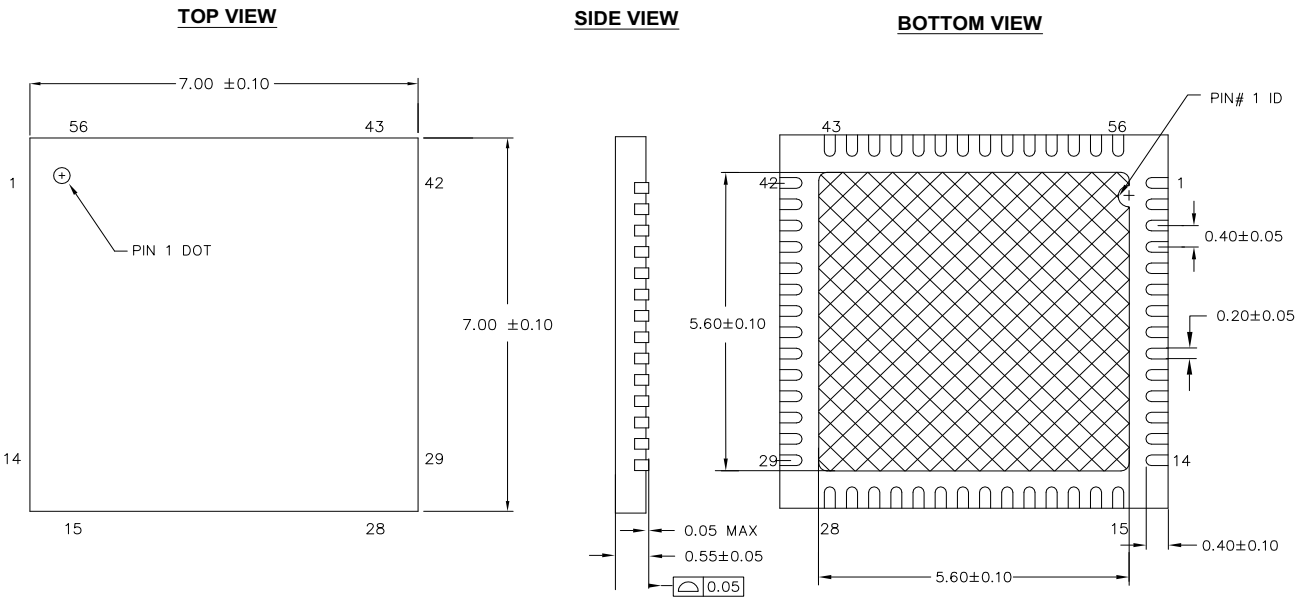

NOTES:

1.  HATCH AREA IS SOLDERABLE EXPOSED PAD
2. BASED ON REF JEDEC # MO-248
3. ALL DIMENSIONS ARE IN MILLIMETERS

001-58740 *C

Figure 17. 56-pin QFN (8 × 8 × 1.0 mm) LF56A/LY56A 4.5 × 5.2 E-Pad (Subcon Punch Type Pkg.) Package Outline, 001-12921

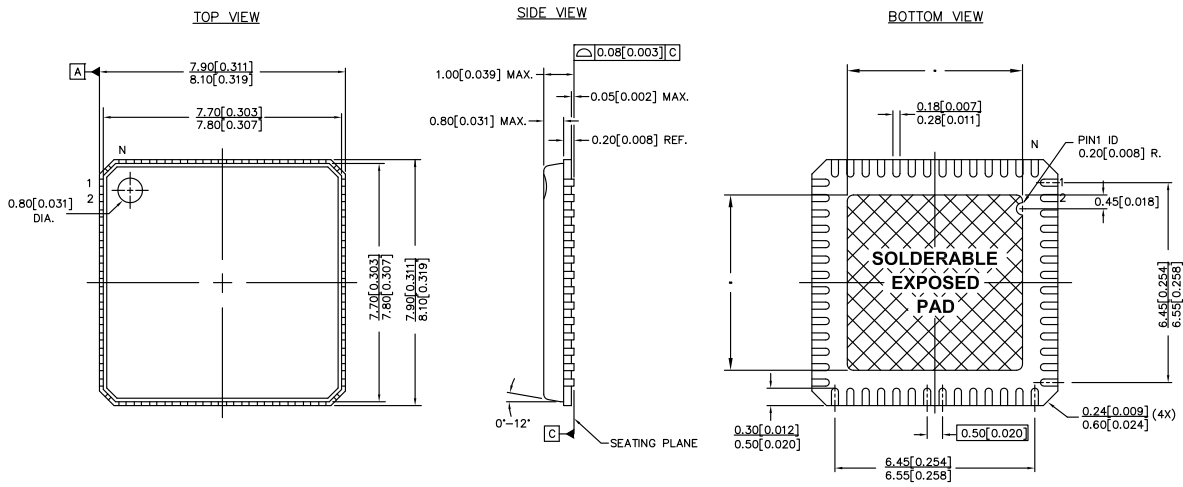

NOTES:

1.  HATCH AREA IS SOLDERABLE EXPOSED METAL.
2. REFERENCE JEDEC#: MO-220
3. PACKAGE WEIGHT: 0.162g
4. ALL DIMENSIONS ARE IN MM [MIN/MAX]
5. PACKAGE CODE

PART #	DESCRIPTION
LF56A	STANDARD
LY56A	PB-FREE

001-12921 *C

Figure 18. 56-pin QFN (8 × 8 × 1.0 mm) LT56B 4.5 × 5.2 E-Pad (Sawn) Package Outline, 001-53450

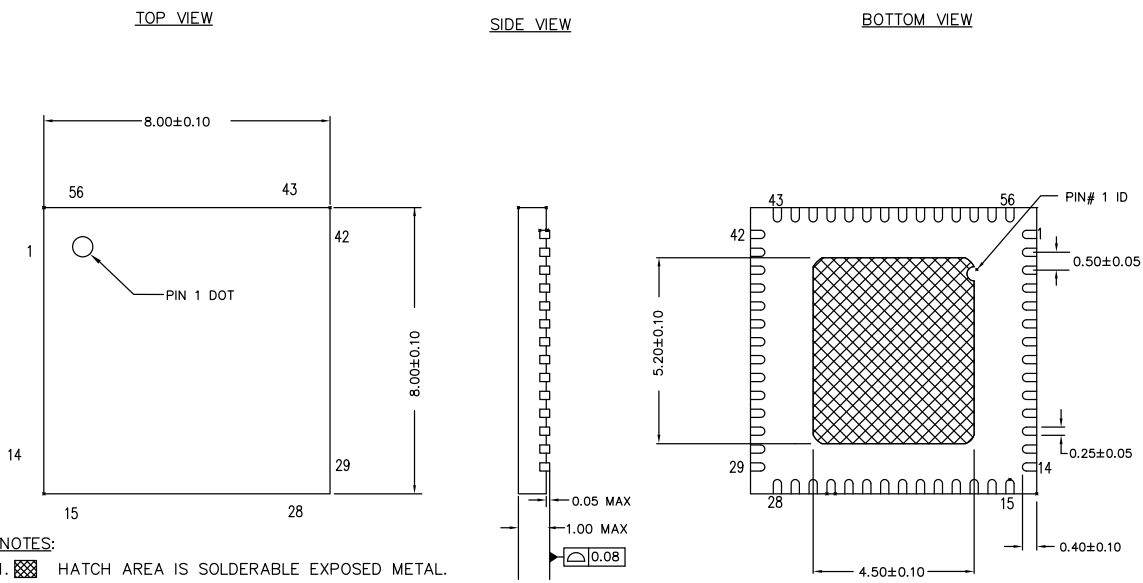

NOTES:

1.  HATCH AREA IS SOLDERABLE EXPOSED METAL.
2. REFERENCE JEDEC#: MO-220
3. PACKAGE WEIGHT: 162 ± 16 mg
4. ALL DIMENSIONS ARE IN MILLIMETERS

001-53450 *D

Figure 19. 68-pin QFN (8 × 8 × 1.0 mm) LT68 5.7 × 5.7 E-Pad (Sawn Type) Package Outline, 001-09618

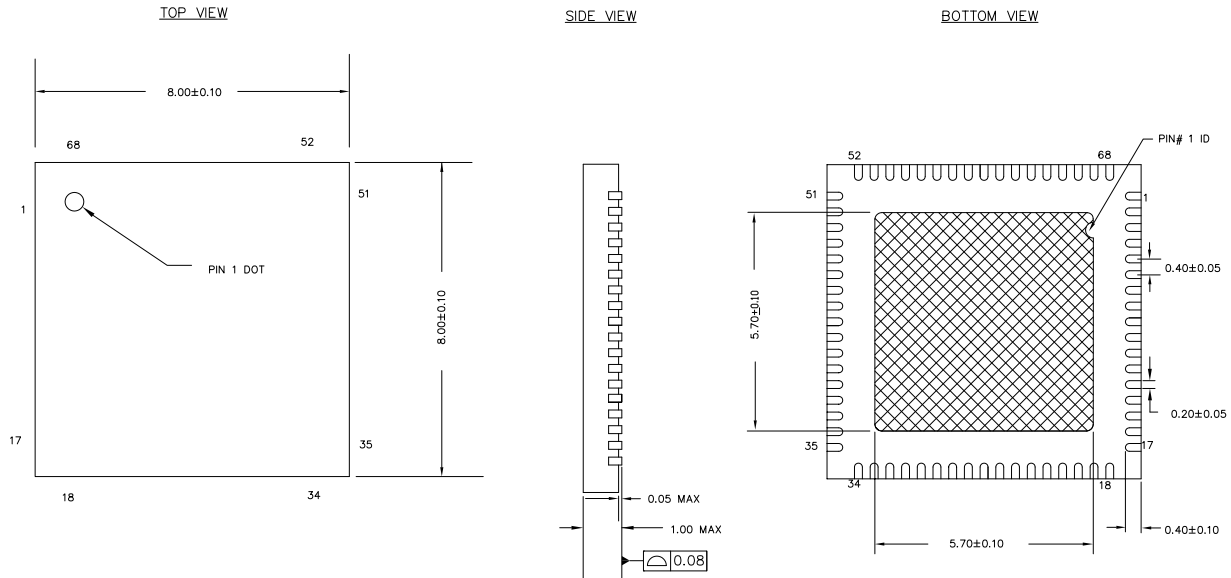

NOTES:

1.  HATCH AREA IS SOLDERABLE EXPOSED METAL.
2. REFERENCE JEDEC#: MO-220
3. PACKAGE WEIGHT: 17 ± 2mg
4. ALL DIMENSIONS ARE IN MILLIMETERS

001-09618 *E

Figure 20. 100-ball VFBGA (6 × 6 × 1.0 mm) BZ100 Package Outline, 51-85209

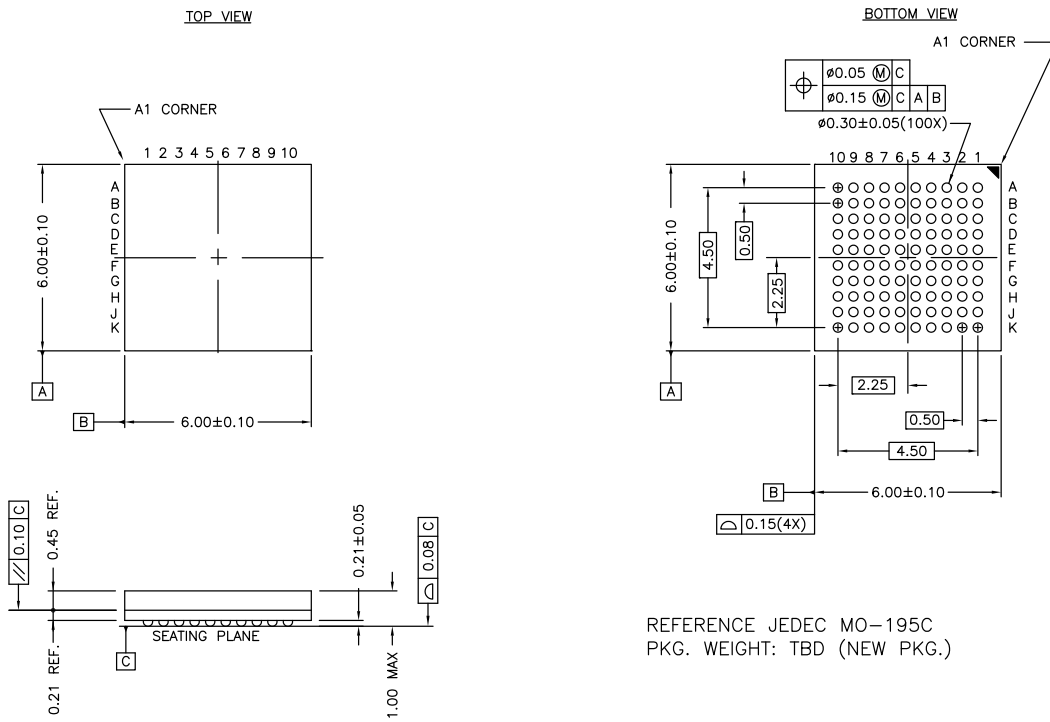

REFERENCE JEDEC MO-195C
PKG. WEIGHT: TBD (NEW PKG.)

51-85209 *F

Figure 21. 100-pin TQFP (14 × 14 × 1.4 mm) A100SA Package Outline, 51-85048

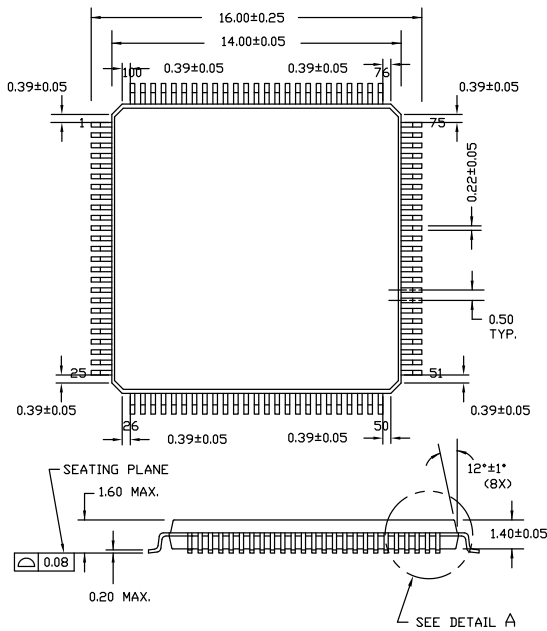

NOTE:

1. JEDEC STD REF MS-026
2. BODY LENGTH DIMENSION DOES NOT INCLUDE MOLD PROTRUSION/END FLASH
MOLD PROTRUSION/END FLASH SHALL NOT EXCEED 0.0098 in (0.25 mm) PER SIDE
BODY LENGTH DIMENSIONS ARE MAX PLASTIC BODY SIZE INCLUDING MOLD MISMATCH
3. DIMENSIONS IN MILLIMETERS

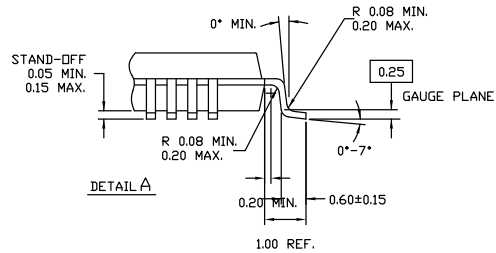

NOTE: PKG. CAN HAVE

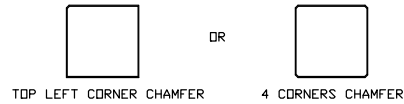

51-85048 *J

Important Note

- For information on the preferred dimensions for mounting QFN packages, see the Application Note, *Application Notes for Surface Mount Assembly of Amkor's MicroLeadFrame (MLF) Packages* available at <http://www.amkor.com>.
- Pinned vias for thermal conduction are not required for the low power PSoC device.

15. Acronyms

15.1 Acronyms Used

The following table lists the acronyms that are used in this document.

Acronym	Description	Acronym	Description
AC	alternating current	MIPS	million instructions per second
ADC	analog-to-digital converter	OCD	on-chip debug
API	application programming interface	PCB	printed circuit board
CMOS	complementary metal oxide semiconductor	PDIP	plastic dual-in-line package
CPU	central processing unit	PGA	programmable gain amplifier
CRC	cyclic redundancy check	POR	power-on reset
CT	continuous time	PPOR	precision power-on reset
DAC	digital-to-analog converter	PRS	pseudo-random sequence
DC	direct current	PSoC [®]	Programmable System-on-Chip [™]
DTMF	dual-tone multi-frequency	PWM	pulse-width modulator
EEPROM	electrically erasable programmable read-only memory	QFN	quad flat no leads
GPIO	general purpose I/O	SAR	successive approximation register
ICE	in-circuit emulator	SC	switched capacitor
IDE	integrated development environment	SLIMO	slow IMO
ILO	internal low-speed oscillator	SOIC	small-outline integrated circuit
IMO	internal main oscillator	SPI [™]	serial peripheral interface
I/O	input/output	SRAM	static random-access memory
IrDA	infrared data association	SROM	supervisory read-only memory
ISSP	In-System Serial Programming	TQFP	thin quad flat pack
LCD	liquid crystal display	UART	universal asynchronous receiver / transmitter
LED	light-emitting diode	USB	universal serial bus
LPC	low power comparator	VFBGA	very fine-pitch ball grid array
LVD	low-voltage detect	WDT	watchdog timer
MAC	multiply-accumulate	XRES	external reset
MCU	microcontroller unit		

16. Document Conventions

16.1 Units of Measure

Symbol	Unit of Measure	Symbol	Unit of Measure
°C	degree Celsius	mV	millivolt
dB	decibels	nA	nanoampere
fF	femtofarad	ns	nanosecond
kHz	kilohertz	nV	nanovolt
kΩ	kilohms	Ω	ohms
MHz	megahertz	pA	picoampere
μA	microampere	pF	picofarad
μs	microsecond	ps	picosecond
μV	microvolt	%	percent
mA	milliampere	rt-Hz	root hertz
mm	millimeter	V	volt
ms	millisecond	W	watt

16.2 Numeric Conventions

Hexadecimal numbers are represented with all letters in uppercase with an appended lowercase 'h' (for example, '14h' or '3Ah'). Hexadecimal numbers may also be represented by a '0x' prefix, the C coding convention. Binary numbers have an appended lowercase 'b' (for example, '01010100b' or '01000011b'). Numbers not indicated by an 'h' or 'b' are decimal.

17. Glossary

active high	<ol style="list-style-type: none"> 6. A logic signal having its asserted state as the logic 1 state. 7. A logic signal having the logic 1 state as the higher voltage of the two states.
analog blocks	The basic programmable opamp circuits. These are SC (switched capacitor) and CT (continuous time) blocks. These blocks can be interconnected to provide ADCs, DACs, multi-pole filters, gain stages, and much more.
analog-to-digital (ADC)	A device that changes an analog signal to a digital signal of corresponding magnitude. Typically, an ADC converts a voltage to a digital number. The digital-to-analog (DAC) converter performs the reverse operation.
API (Application Programming Interface)	A series of software routines that comprise an interface between a computer application and lower level services and functions (for example, user modules and libraries). APIs serve as building blocks for programmers that create software applications.
asynchronous	A signal whose data is acknowledged or acted upon immediately, irrespective of any clock signal.
Bandgap reference	A stable voltage reference design that matches the positive temperature coefficient of VT with the negative temperature coefficient of VBE, to produce a zero temperature coefficient (ideally) reference.
bandwidth	<ol style="list-style-type: none"> 1. The frequency range of a message or information processing system measured in hertz. 2. The width of the spectral region over which an amplifier (or absorber) has substantial gain (or loss); it is sometimes represented more specifically as, for example, full width at half maximum.
bias	<ol style="list-style-type: none"> 1. A systematic deviation of a value from a reference value. 2. The amount by which the average of a set of values departs from a reference value. 3. The electrical, mechanical, magnetic, or other force (field) applied to a device to establish a reference level to operate the device.

17. Glossary *(continued)*

block	<ol style="list-style-type: none">1. A functional unit that performs a single function, such as an oscillator.2. A functional unit that may be configured to perform one of several functions, such as a digital PSoC block or an analog PSoC block.
buffer	<ol style="list-style-type: none">1. A storage area for data that is used to compensate for a speed difference, when transferring data from one device to another. Usually refers to an area reserved for IO operations, into which data is read, or from which data is written.2. A portion of memory set aside to store data, often before it is sent to an external device or as it is received from an external device.3. An amplifier used to lower the output impedance of a system.
bus	<ol style="list-style-type: none">1. A named connection of nets. Bundling nets together in a bus makes it easier to route nets with similar routing patterns.2. A set of signals performing a common function and carrying similar data. Typically represented using vector notation; for example, address[7:0].3. One or more conductors that serve as a common connection for a group of related devices.
clock	The device that generates a periodic signal with a fixed frequency and duty cycle. A clock is sometimes used to synchronize different logic blocks.
comparator	An electronic circuit that produces an output voltage or current whenever two input levels simultaneously satisfy predetermined amplitude requirements.
compiler	A program that translates a high level language, such as C, into machine language.
configuration space	In PSoC devices, the register space accessed when the XIO bit, in the CPU_F register, is set to '1'.
crystal oscillator	An oscillator in which the frequency is controlled by a piezoelectric crystal. Typically a piezoelectric crystal is less sensitive to ambient temperature than other circuit components.
cyclic redundancy check (CRC)	A calculation used to detect errors in data communications, typically performed using a linear feedback shift register. Similar calculations may be used for a variety of other purposes such as data compression.
data bus	A bi-directional set of signals used by a computer to convey information from a memory location to the central processing unit and vice versa. More generally, a set of signals used to convey data between digital functions.
debugger	A hardware and software system that allows the user to analyze the operation of the system under development. A debugger usually allows the developer to step through the firmware one step at a time, set break points, and analyze memory.
dead band	A period of time when neither of two or more signals are in their active state or in transition.
digital blocks	The 8-bit logic blocks that can act as a counter, timer, serial receiver, serial transmitter, CRC generator, pseudo-random number generator, or SPI.
digital-to-analog (DAC)	A device that changes a digital signal to an analog signal of corresponding magnitude. The analog-to-digital (ADC) converter performs the reverse operation.
duty cycle	The relationship of a clock period high time to its low time, expressed as a percent.
emulator	Duplicates (provides an emulation of) the functions of one system with a different system, so that the second system appears to behave like the first system.

17. Glossary (continued)

external reset (XRES)	An active high signal that is driven into the PSoC device. It causes all operation of the CPU and blocks to stop and return to a pre-defined state.
flash	An electrically programmable and erasable, non-volatile technology that provides users with the programmability and data storage of EPROMs, plus in-system erasability. Non-volatile means that the data is retained when power is off.
Flash block	The smallest amount of Flash ROM space that may be programmed at one time and the smallest amount of Flash space that may be protected. A Flash block holds 64 bytes.
frequency	The number of cycles or events per unit of time, for a periodic function.
gain	The ratio of output current, voltage, or power to input current, voltage, or power, respectively. Gain is usually expressed in dB.
I ² C	A two-wire serial computer bus by Philips Semiconductors (now NXP Semiconductors). I2C is an Inter-Integrated Circuit. It is used to connect low-speed peripherals in an embedded system. The original system was created in the early 1980s as a battery control interface, but it was later used as a simple internal bus system for building control electronics. I2C uses only two bi-directional pins, clock and data, both running at +5V and pulled high with resistors. The bus operates at 100 kbits/second in standard mode and 400 kbits/second in fast mode.
ICE	The in-circuit emulator that allows users to test the project in a hardware environment, while viewing the debugging device activity in a software environment (PSoC Designer).
input/output (I/O)	A device that introduces data into or extracts data from a system.
interrupt	A suspension of a process, such as the execution of a computer program, caused by an event external to that process, and performed in such a way that the process can be resumed.
interrupt service routine (ISR)	A block of code that normal code execution is diverted to when the M8C receives a hardware interrupt. Many interrupt sources may each exist with its own priority and individual ISR code block. Each ISR code block ends with the RETI instruction, returning the device to the point in the program where it left normal program execution.
jitter	<ol style="list-style-type: none"> 1. A misplacement of the timing of a transition from its ideal position. A typical form of corruption that occurs on serial data streams. 2. The abrupt and unwanted variations of one or more signal characteristics, such as the interval between successive pulses, the amplitude of successive cycles, or the frequency or phase of successive cycles.
low-voltage detect (LVD)	A circuit that senses V_{DD} and provides an interrupt to the system when V_{DD} falls lower than a selected threshold.
M8C	An 8-bit Harvard-architecture microprocessor. The microprocessor coordinates all activity inside a PSoC by interfacing to the Flash, SRAM, and register space.
master device	A device that controls the timing for data exchanges between two devices. Or when devices are cascaded in width, the master device is the one that controls the timing for data exchanges between the cascaded devices and an external interface. The controlled device is called the slave device .
microcontroller	An integrated circuit chip that is designed primarily for control systems and products. In addition to a CPU, a microcontroller typically includes memory, timing circuits, and IO circuitry. The reason for this is to permit the realization of a controller with a minimal quantity of chips, thus achieving maximal possible miniaturization. This in turn, reduces the volume and the cost of the controller. The microcontroller is normally not used for general-purpose computation as is a microprocessor.
mixed-signal	The reference to a circuit containing both analog and digital techniques and components.

17. Glossary *(continued)*

modulator	A device that imposes a signal on a carrier.
noise	<ol style="list-style-type: none">1. A disturbance that affects a signal and that may distort the information carried by the signal.2. The random variations of one or more characteristics of any entity such as voltage, current, or data.
oscillator	A circuit that may be crystal controlled and is used to generate a clock frequency.
parity	A technique for testing transmitting data. Typically, a binary digit is added to the data to make the sum of all the digits of the binary data either always even (even parity) or always odd (odd parity).
phase-locked loop (PLL)	An electronic circuit that controls an oscillator so that it maintains a constant phase angle relative to a reference signal.
pinouts	The pin number assignment: the relation between the logical inputs and outputs of the PSoC device and their physical counterparts in the printed circuit board (PCB) package. Pinouts involve pin numbers as a link between schematic and PCB design (both being computer generated files) and may also involve pin names.
port	A group of pins, usually eight.
power on reset (POR)	A circuit that forces the PSoC device to reset when the voltage is lower than a pre-set level. This is one type of hardware reset.
PSoC [®]	Cypress Semiconductor's PSoC [®] is a registered trademark and Programmable System-on-Chip [™] is a trademark of Cypress.
PSoC Designer [™]	The software for Cypress' Programmable System-on-Chip technology.
pulse width modulator (PWM)	An output in the form of duty cycle which varies as a function of the applied measurand
RAM	An acronym for random access memory. A data-storage device from which data can be read out and new data can be written in.
register	A storage device with a specific capacity, such as a bit or byte.
reset	A means of bringing a system back to a know state. See hardware reset and software reset.
ROM	An acronym for read only memory. A data-storage device from which data can be read out, but new data cannot be written in.
serial	<ol style="list-style-type: none">1. Pertaining to a process in which all events occur one after the other.2. Pertaining to the sequential or consecutive occurrence of two or more related activities in a single device or channel.
settling time	The time it takes for an output signal or value to stabilize after the input has changed from one value to another.
shift register	A memory storage device that sequentially shifts a word either left or right to output a stream of serial data.
slave device	A device that allows another device to control the timing for data exchanges between two devices. Or when devices are cascaded in width, the slave device is the one that allows another device to control the timing of data exchanges between the cascaded devices and an external interface. The controlling device is called the master device.

17. Glossary *(continued)*

SRAM	An acronym for static random access memory. A memory device allowing users to store and retrieve data at a high rate of speed. The term static is used because, after a value has been loaded into an SRAM cell, it remains unchanged until it is explicitly altered or until power is removed from the device.
SROM	An acronym for supervisory read only memory. The SROM holds code that is used to boot the device, calibrate circuitry, and perform Flash operations. The functions of the SROM may be accessed in normal user code, operating from Flash.
stop bit	A signal following a character or block that prepares the receiving device to receive the next character or block.
synchronous	<ol style="list-style-type: none">1. A signal whose data is not acknowledged or acted upon until the next active edge of a clock signal.2. A system whose operation is synchronized by a clock signal.
tristate	A function whose output can adopt three states: 0, 1, and Z (high-impedance). The function does not drive any value in the Z state and, in many respects, may be considered to be disconnected from the rest of the circuit, allowing another output to drive the same net.
UART	A UART or universal asynchronous receiver-transmitter translates between parallel bits of data and serial bits.
user modules	Pre-build, pre-tested hardware/firmware peripheral functions that take care of managing and configuring the lower level Analog and Digital PSoC Blocks. User Modules also provide high level API (Application Programming Interface) for the peripheral function.
user space	The bank 0 space of the register map. The registers in this bank are more likely to be modified during normal program execution and not just during initialization. Registers in bank 1 are most likely to be modified only during the initialization phase of the program.
V_{DD}	A name for a power net meaning "voltage drain." The most positive power supply signal. Usually 5 V or 3.3 V.
V_{SS}	A name for a power net meaning "voltage source." The most negative power supply signal.
watchdog timer	A timer that must be serviced periodically. If it is not serviced, the CPU resets after a specified period of time.

18. Errata

This section describes the errata for the CY8C24x94 device. Details include errata trigger conditions, scope of impact, available workaround, and silicon revision applicability. Contact your local Cypress Sales Representative if you have questions.

Part Numbers Affected

Part Number
CY8C24x94

CY8C24x94 Errata Summary

The following table defines the errata applicability to available devices.

Items	Part Number
1. The DP line of the USB interface may pulse low when the PSoC device wakes from sleep causing an unexpected wake-up of the host computer.	CY8C24x94
2. Invalid Flash reads may occur if Vdd is pulled to -0.5 V just before power on.	CY8C24x94
3. PMA Index Register fails to auto-increment with CPU_Clock set to SysClk/1 (24 MHz).	CY8C24x94
4. The Internal Main Oscillator (IMO) frequency parameter (FIMO245V) may increase over a period of time during usage in the field and exceed the maximum spec limit of 24.96 MHz.	CY8C24x94

1. The DP line of the USB interface may pulse low when the PSoC device wakes from sleep causing an unexpected wake-up of the host computer.

■ PROBLEM DEFINITION

When the device is operating at 4.75 V to 5.25 V and the 3.3 V regulator is enabled, a short low pulse may be created on the DP signal line during device wake-up. The 15-20 μ s low pulse of the DP line may be interpreted by the host computer as a deattach or the beginning of a wake-up.

■ TRIGGER CONDITION(S)

The bandgap reference voltage used by the 3.3 V regulator decreases during sleep due to leakage. Upon device wake up, the bandgap is reenabled and after a delay for settling, the 3.3 V regulator is enabled. On some devices the 3.3 V regulator that is used to generate the USB DP signal may be enabled before the bandgap is fully stabilized. This can cause a low pulse on the regulator output and DP signal line until the bandgap stabilizes. In applications where Vdd is 3.3 V, the regulator is not used and therefore the DP low pulse is not generated.

■ WORKAROUND

To prevent the DP signal from pulsing low, keep the bandgap enabled during sleep. The most efficient method is to set the No Buzz bit in the OSC_CR0 register. The No Buzz bit keeps the bandgap powered and output stable during sleep. Setting the No Buzz bit results in nominal 100 μ A increase to sleep current. Leaving the analog reference block enabled during sleep also resolves this issue because it forces the bandgap to remain enabled. An example for disabling the No Buzz bit is listed below.

Assembly

```
M8C_SetBank1
or reg[OSC_CR0], 0x20
M8C_SetBank0
```

C

```
OSC_CR0 |= 0x20;
```

2. Invalid Flash reads may occur if Vdd is pulled to -0.5 V just before power on.

■ PROBLEM DEFINITION

When Vdd of the device is pulled below ground just before power on, the first read from each 8K Flash page may be corrupted. This issue does not affect Flash page 0 because it is the selected page upon reset.

■ TRIGGER CONDITION(S)

When Vdd is pulled below ground before power on, an internal Flash reference may deviate from its nominal voltage. The reference deviation tends to result in the first Flash read from that page returning 0xFF. During the first read from each page, the reference is reset resulting in all future reads returning the correct value. A short delay of 5 μ s before the first real read provides time for the reference voltage to stabilize.

■ WORKAROUND

To prevent an invalid Flash read, a dummy read from each Flash page must occur before use of the pages. A delay of 5 μ s must occur after the dummy read and before a real read. The dummy reads occurs as soon as possible and must be located in Flash page 0 before a read from any other Flash page. An example for reading a byte of memory from each Flash page is listed below. Placed it in boot.tpl and boot.asm immediately after the 'start:' label.

```
// dummy read from each 8K Flash page
// page 1
mov A, 0x20      // MSB
mov X, 0x00      // LSB
romx
// wait at least 5  $\mu$ s
mov X, 14
loop1:
dec X
jnz loop1
```

3. PMA Index Register fails to auto-increment with CPU_Clock set to SysClk/1 (24 MHz).

■ PROBLEM DEFINITION

When the device is operating at 4.75 to 5.25 V and the CPU_Clock is set to SysClk/1 (24 MHz), the USB PMA Index Register may fail to increment automatically when used in an OUT endpoint configuration at Full-Speed. When the application program attempts to use the bReadOutEP() function the first byte in the PMA buffer is always returned.

■ TRIGGER CONDITION(S)

An internal flip-flop hold problem associated with Index Register increment function. All reads of the associated RAM originate from the first byte. The hold problem has no impact on other circuits or functions within the device.

■ WORKAROUND

To make certain that the index register properly increments, set the CPU_Clock to SysClk/2 (12 MHz) during the read of the PMA buffer. An example for the clock adjustment method is listed below.

PSoC Designer™ 4.3 User Module workaround: PSoC Designer Release 4.3 and subsequent releases includes a revised full-speed USB User Module with the revised firmware work-around included (see example below).

```
;;
;; 24 MHz read PMA workaround
;;
M8C_SetBank1
mov A, reg[OSC_CR0]
push A
and A, 0xf8 ;clear the clock bits (briefly chg the cpu_clk to 3 MHz)
or A, 0x02 ;will set clk to 12Mhz

mov reg[OSC_CR0],A ;clk is now set at 12 MHz
M8C_SetBank0
.loop:
  mov A, reg[PMA0_DR] ; Get the data from the PMA space
  mov [X], A ; save it in data array
  inc X ; increment the pointer
  dec [USB_APITemp+1] ; decrement the counter
  jnz .loop ; wait for count to zero out
;;
;; 24MHz read PMA workaround (back to previous clock speed)
;;
pop A ;recover previous reg[OSC_CR0] value
M8C_SetBank1
mov reg[OSC_CR0],A ;clk is now set at previous value
M8C_SetBank0
;;
;; end 24Mhz read PMA workaround
```

4. The Internal Main Oscillator (IMO) frequency parameter (FIMO245V) may increase over a period of time during usage in the field and exceed the maximum spec limit of 24.96 MHz.

■ **PROBLEM DEFINITION**

When the device has been operating at 4.75 V to 5.25 V for a cumulatively long duration in the field, the IMO Frequency may slowly increase over the duration of usage in the field and eventually exceed the maximum spec limit of 24.96 MHz. This may affect applications that are sensitive to the max value of IMO frequency, such as those using UART communication and result in a functional failure.

■ **TRIGGER CONDITION(S)**

Very long (cumulative) usage of the device in the operating voltage range of 4.75V to 5.25V, with the IMO clock running continuously, could lead to the degradation. Higher power supply voltage and lower ambient temperature are worst-case conditions for the degradation.

■ **WORKAROUND**

Operating the device with the power supply voltage range of 3.0 V to 3.6 V, would avoid the degradation of IMO Frequency beyond the max spec limit of 24.96 MHz.

■ **FIX STATUS**

A new revision of the silicon, with a fix for this issue, is expected to be available from August 1st 2015.

19. Document History Page

Document Title: CY8C24094/CY8C24794/CY8C24894/CY8C24994, PSoC [®] Programmable System-on-Chip [™]				
Document Number: 38-12018				
Revision	ECN	Orig. of Change	Submission Date	Description of Change
**	133189	NWJ	01/27/2004	New silicon and new document – Advance datasheet.
*A	251672	SFV	See ECN	First Preliminary datasheet. Changed title to encompass only the CY8C24794 because the CY8C24494 and CY8C24694 are not being offered by Cypress.
*B	289742	HMT	See ECN	Add standard DS items from SFV memo. Add Analog Input Mux on pinouts. 2 MACs. Change 512 bytes of SRAM to 1 K. Add dimension key to package. Remove HAPI. Update diagrams, registers and specs.
*C	335236	HMT	See ECN	Add CY logo. Update CY copyright. Update new CY.com URLs. Re-add ISSP programming pinout notation. Add Reflow Temp. table. Update features (MAC, Oscillator, and voltage range), registers (INT_CLR2/MSK2, second MAC), and specs. (Rext, IMO, analog output buffer...).
*D	344318	HMT	See ECN	Add new color and logo. Expand analog arch. diagram. Fix I/O #. Update Electrical Specifications.
*E	346774	HMT	See ECN	Add USB temperature specifications. Make datasheet Final.
*F	349566	HMT	See ECN	Remove USB logo. Add URL to preferred dimensions for mounting MLF packages.
*G	393164	HMT	See ECN	Add new device, CY8C24894 56-pin MLF with XRES pin. Add Fimousb3v char. to specs. Upgrade to CY Perform logo and update corporate address and copyright.
*H	469243	HMT	See ECN	Add ISSP note to pinout tables. Update typical and recommended Storage Temperature per industrial specs. Update Low Output Level maximum I/OL budget. Add FLS_PR1 to Register Map Bank 1 for users to specify which Flash bank should be used for SROM operations. Add two new devices for a 68-pin QFN and 100-ball VFBGA under RPNs: CY8C24094 and CY8C24994. Add two packages for 68-pin QFN. Add OCD non-production pinouts and package diagrams. Update CY branding and QFN convention. Add new Dev. Tool section. Update copyright and trademarks.
*I	561158	HMT	See ECN	Add Low Power Comparator (LPC) AC/DC electrical spec. tables. Add CY8C20x34 to PSoC Device Characteristics table. Add detailed dimensions to 56-pin QFN package diagram and update revision. Secure one package diagram/manufacturing per QFN. Update emulation pod/feet kit part numbers. Fix pinout type-o per TestTrack.
*J	728238	HMT	See ECN	Add CapSense SNR requirement reference. Update figure standards. Update Technical Training paragraphs. Add QFN package clarifications and dimensions. Update ECN-ed Amkor dimensioned QFN package diagram revisions. Reword SNR reference. Add new 56-pin QFN spec.
*K	2552459	AZIE / PYRS	08/14/08	Add footnote on AGND descriptions to avoid using P2[4] for digital signaling as it may add noise to AGND. Remove reference to CMP_GO_EN1 in Map Bank 1 Table on Address 65; this register has no functionality on 24xxx. Add footnote on die sales. Add description 'Optional External Clock Input' on P1[4] to match description of P1[4].
*L	2616550	OGNE / PYRS	12/05/08	Updated Programmable Pin Configuration detail. Changed title from PSoC [®] Mixed-Signal Array to PSoC [®] Programmable System-on-Chip [™]
*M	2657956	DPT / PYRS	02/11/09	Added package diagram 001-09618 and updated Ordering Information table

19. Document History Page *(continued)*

Document Title: CY8C24094/CY8C24794/CY8C24894/CY8C24994, PSoC [®] Programmable System-on-Chip™				
Document Number: 38-12018				
*N	2708135	BRW	05/18/2009	Added Note in the Pin Information section on page 8. Removed reference to Hi-Tech Lite Compiler in the section Development Tools Selection on page 42.
*O	2718162	DPT	06/11/2009	Added 56-Pin QFN (Sawn) package diagram and updated ordering information
*P	2762161	RLRM	09/10/2009	Updated the following parameters: DC _{ILO} , F _{32K_U} , F _{IMO6} , T _{POWERUP} , T _{ERASE_ALL} , T _{PROGRAM_HOT} , and T _{PROGRAM_COLD} . Added SR _{POWER_UP} parameter in AC specs table.
*Q	2768530	RLRM	09/24/09	Ordering Information table: Changed XRES Pin value for CY8C24894-24LTXI and CY8C24894-24LTXIT to 'Yes'.
*R	2817938	KRIS	11/30/09	Ordering Information : Updated CY8C24894-24LTXI and CY8C24894-24LTXIT parts as Sawn and updated the Digital I/O and Analog Pin values Added Contents page. Updated 68 QFN package diagram (51-85124)
*S	2846641	RLRM	1/12/10	Added package diagram 001-58740 and updated Development Tools section.
*T	2867363	ANUP	01/27/10	Modified Note 9 to remove voltage range 2.4 V to 3.0 V
*U	2901653	NJF	03/30/2010	Updated Cypress website links Added T _{XRST} , DC24M, T _{BAKETEMP} and T _{BAKETIME} parameters Removed reference to 2.4 V Removed sections 'Third Party Tools' 'Build a PSoC Emulator into your Board' Updated package diagrams Removed inactive parts from ordering information table.
*V	2938528	VMAD	05/28/2010	Updated content to match current style guide and datasheet template. No technical updates
*W	3028596	NJF	09/20/10	Added PSoC Device Characteristics table. Added DC I ² C Specifications table. Added F _{32K_U} max limit. Added T _{jitter_IMO} specification, removed existing jitter specifications. Updated Analog reference tables. Updated Units of Measure, Acronyms, Glossary, and References sections. Updated solder reflow specifications. No specific changes were made to AC Digital Block Specifications table and I ² C Timing Diagram. They were updated for clearer understanding. Updated Figure 12 since the labelling for y-axis was incorrect. Template and styles update.
*X	3082244	NXZ	11/09/2010	Sunset review; no updates.
*Y	3111357	BTK / NJF / ARVM	12/15/10	Updated solder reflow specifications. Removed F _{IMO6} spec from AC chip-level specifications table. Removed the following pruned parts from the ordering information table and their references in the datasheet. 1) CY8C24794-24LFXI 2) CY8C24794-24LFXIT 3) CY8C24894-24LFXI 4) CY8C24894-24LFXIT
*Z	3126167	BTK / ANBA / PKS	01/03/11	Updated ordering information. Removed the package diagram spec 51-85214 since there are no MPNs in the ordering information table that corresponds with this package. Updated ordering code definitions for clearer understanding.
AA	3367463	BTK / GIR	09/22/11	Updated V _{REFHI} values for parameter '0b100' under Table 19 on page 31 . Updated text under Table 19 on page 31 . The text "Pin must be left floating" is included under Description of NC pin in Table 4 on page 12 , Table 6 on page 14 , Table 7 on page 16 , and Table 8 on page 18 . Updated Table 38 on page 51 to give more clarity.
AB	3404970	MATT	10/13/11	Removed prune device CY8C24994-24BVXI from Ordering Information .
AC	3461872	CSAI	12/13/2011	Sunset review; no content update

19. Document History Page *(continued)*

Document Title: CY8C24094/CY8C24794/CY8C24894/CY8C24994, PSoC® Programmable System-on-Chip™ Document Number: 38-12018				
AD	3503402	PMAD	01/20/2012	Updated V _{OH} and V _{OL} section in Table 12 .
AE	3545509	PSAI	03/08/2012	Updated link to 'Technical reference Manual'.
AF	3862667	CSAI	01/09/2013	Updated Ordering Information (Updated part numbers). Updated Packaging Dimensions : spec 001-53450 – Changed revision from *B to *C. spec 001-09618 – Changed revision from *D to *E. spec 51-85048 – Changed revision from *E to *G.
AG	3979302	CSAI	04/23/2013	Updated Packaging Dimensions : spec 001-58740 – Changed revision from ** to *A. Added Errata .
AH	4074544	CSAI	07/23/2013	Added Errata Footnotes (Note 21, 23) Updated Electrical Specifications : Updated DC Electrical Characteristics : Updated DC Chip-Level Specifications : Added Note 21 and referred the same note in “Sleep Mode” in description of I _{SB} parameter in Table 11 . Updated DC POR and LVD Specifications : Added Note 23 and referred the same note in V _{PPOR0} , V _{PPOR1} , V _{PPOR2} parameters in Table 22 . Updated to new template.
AI	4596835	DIMA	12/15/2014	Updated Pin Information : Updated 56-Pin Part Pinout : Updated Table 2 : Added Note 5 and referred the same note in description of pin 19 and pin 50. Updated 56-Pin Part Pinout (with XRES) : Updated Table 3 : Added Note 8 and referred the same note in description of pin 19 and pin 50. Updated 68-Pin Part Pinout : Updated Table 4 : Added Note 10 and referred the same note in description of pin 7, pin 20 and pin 60. Updated 68-Pin Part Pinout (On-Chip Debug) : Updated Table 5 : Added Note 13 and referred the same note in description of pin 7, pin 20 and pin 60. Updated 100-Ball VFBGA Part Pinout : Updated Table 6 : Added Note 15 and referred the same note in caption of Table 6 . Updated 100-Ball VFBGA Part Pinout (On-Chip Debug) : Updated Table 7 : Added Note 17 and referred the same note in caption of Table 7 . Updated 100-Pin Part Pinout (On-Chip Debug) : Updated Table 8 : Added Note 19 and referred the same note in caption of Table 8 . Updated Packaging Dimensions : spec 001-12921 – Changed revision from *B to *C. spec 001-53450 – Changed revision from *C to *D. spec 51-85209 – Changed revision from *D to *E. spec 51-85048 – Changed revision from *G to *I. Completing Sunset Review.
AJ	4622083	SLAN	01/13/2015	Added More Information section.
AK	4684565	PSI	03/12/2015	Updated Packaging Dimensions : spec 001-58740 – Changed revision from *A to *B. Updated Errata .
AL	5699855	AESATP12	04/20/2017	Updated logo and copyright.

Sales, Solutions, and Legal Information

Worldwide Sales and Design Support

Cypress maintains a worldwide network of offices, solution centers, manufacturer's representatives, and distributors. To find the office closest to you, visit us at [Cypress Locations](#).

Products

ARM [®] Cortex [®] Microcontrollers	cypress.com/arm
Automotive	cypress.com/automotive
Clocks & Buffers	cypress.com/clocks
Interface	cypress.com/interface
Internet of Things	cypress.com/iot
Memory	cypress.com/memory
Microcontrollers	cypress.com/mcu
PSoC	cypress.com/psoc
Power Management ICs	cypress.com/pmic
Touch Sensing	cypress.com/touch
USB Controllers	cypress.com/usb
Wireless Connectivity	cypress.com/wireless

PSoC[®] Solutions

[PSoC 1](#) | [PSoC 3](#) | [PSoC 4](#) | [PSoC 5LP](#) | [PSoC 6](#)

Cypress Developer Community

[Forums](#) | [WICED IOT Forums](#) | [Projects](#) | [Video](#) | [Blogs](#) | [Training](#) | [Components](#)

Technical Support

cypress.com/support

© Cypress Semiconductor Corporation, 2004-2017. This document is the property of Cypress Semiconductor Corporation and its subsidiaries, including Spansion LLC ("Cypress"). This document, including any software or firmware included or referenced in this document ("Software"), is owned by Cypress under the intellectual property laws and treaties of the United States and other countries worldwide. Cypress reserves all rights under such laws and treaties and does not, except as specifically stated in this paragraph, grant any license under its patents, copyrights, trademarks, or other intellectual property rights. If the Software is not accompanied by a license agreement and you do not otherwise have a written agreement with Cypress governing the use of the Software, then Cypress hereby grants you a personal, non-exclusive, nontransferable license (without the right to sublicense) (1) under its copyright rights in the Software (a) for Software provided in source code form, to modify and reproduce the Software solely for use with Cypress hardware products, only internally within your organization, and (b) to distribute the Software in binary code form externally to end users (either directly or indirectly through resellers and distributors), solely for use on Cypress hardware product units, and (2) under those claims of Cypress's patents that are infringed by the Software (as provided by Cypress, unmodified) to make, use, distribute, and import the Software solely for use with Cypress hardware products. Any other use, reproduction, modification, translation, or compilation of the Software is prohibited.

TO THE EXTENT PERMITTED BY APPLICABLE LAW, CYPRESS MAKES NO WARRANTY OF ANY KIND, EXPRESS OR IMPLIED, WITH REGARD TO THIS DOCUMENT OR ANY SOFTWARE OR ACCOMPANYING HARDWARE, INCLUDING, BUT NOT LIMITED TO, THE IMPLIED WARRANTIES OF MERCHANTABILITY AND FITNESS FOR A PARTICULAR PURPOSE. To the extent permitted by applicable law, Cypress reserves the right to make changes to this document without further notice. Cypress does not assume any liability arising out of the application or use of any product or circuit described in this document. Any information provided in this document, including any sample design information or programming code, is provided only for reference purposes. It is the responsibility of the user of this document to properly design, program, and test the functionality and safety of any application made of this information and any resulting product. Cypress products are not designed, intended, or authorized for use as critical components in systems designed or intended for the operation of weapons, weapons systems, nuclear installations, life-support devices or systems, other medical devices or systems (including resuscitation equipment and surgical implants), pollution control or hazardous substances management, or other uses where the failure of the device or system could cause personal injury, death, or property damage ("Unintended Uses"). A critical component is any component of a device or system whose failure to perform can be reasonably expected to cause the failure of the device or system, or to affect its safety or effectiveness. Cypress is not liable, in whole or in part, and you shall and hereby do release Cypress from any claim, damage, or other liability arising from or related to all Unintended Uses of Cypress products. You shall indemnify and hold Cypress harmless from and against all claims, costs, damages, and other liabilities, including claims for personal injury or death, arising from or related to any Unintended Uses of Cypress products.

Cypress, the Cypress logo, Spansion, the Spansion logo, and combinations thereof, WICED, PSoC, CapSense, EZ-USB, F-RAM, and Traveo are trademarks or registered trademarks of Cypress in the United States and other countries. For a more complete list of Cypress trademarks, visit cypress.com. Other names and brands may be claimed as property of their respective owners.