

## HDSM-531x, HDSM-533x

### 0.56-in. (14.22-mm) Single-Digit Surface-Mount LED Display

---

#### Description

The Broadcom<sup>®</sup> HDSM-531x/533x is a 0.56-in. (14.22-mm) height single-digit display. This device uses an AlInGaP chip. This device has a gray top surface and white segments.

#### Features

- 0.56-in. digit height
- Low current operation
- Excellent characters appearance
- Available in CA and CC
- 1000 pieces per reel
- Moisture sensitivity level: Level 3
- RoHS compliant

#### Ordering Information

Red	Green	Yellow	Orange	Description
HDSM-531C	HDSM-531H	HDSM-531F	HDSM-531L	Common Anode, Right Hand Decimal
HDSM-533C	HDSM-533H	HDSM-533F	HDSM-533L	Common Cathode, Right Hand Decimal

# Package Dimensions

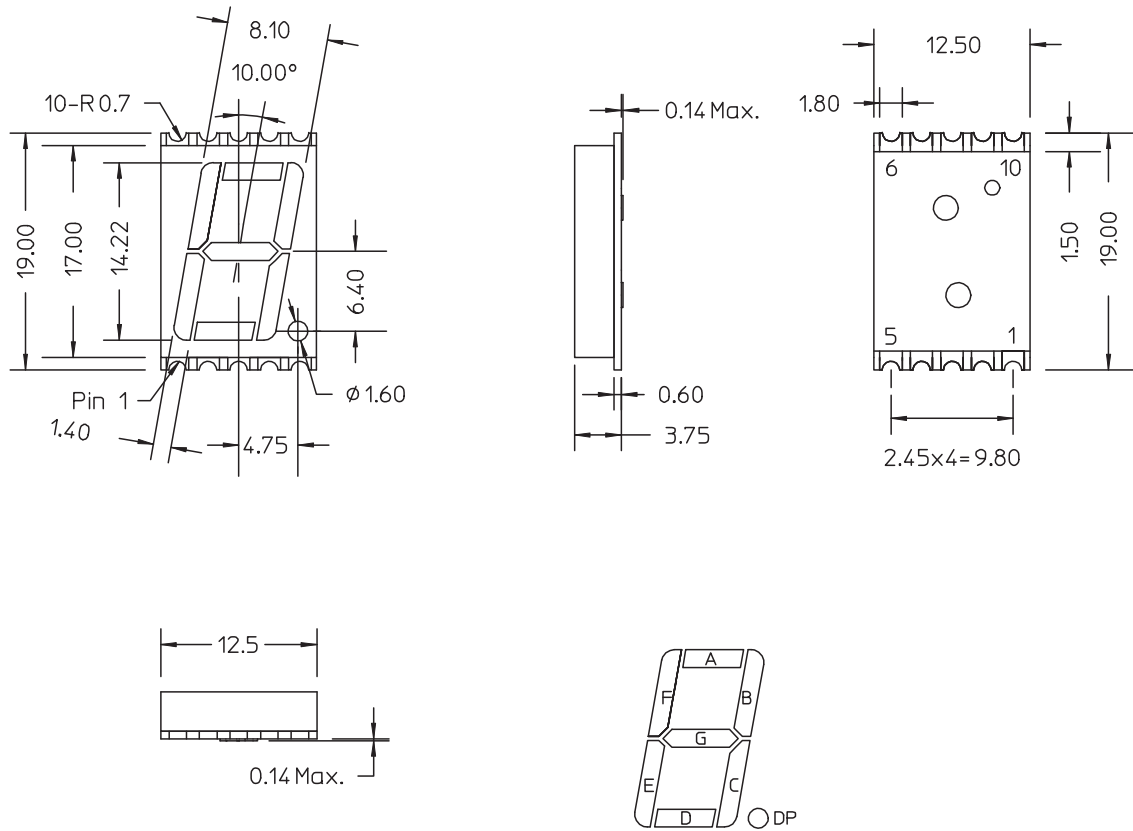

**NOTE:**

1. All dimensions are in millimeters (inches).
2. Tolerance  $\pm 0.25$  mm (0.01 in.) unless otherwise noted.

## Pin Connection (Common Anode)

Pin Number	Connection
1	CATHODE E
2	CATHODE D
3	COMMON ANODE
4	CATHODE C
5	CATHODE DP
6	CATHODE B
7	CATHODE A
8	COMMON ANODE
9	CATHODE F
10	CATHODE G

## Pin Connection (Common Cathode)

Pin Number	Connection
1	ANODE E
2	ANODE D
3	COMMON CATHODE
4	ANODE C
5	ANODE DP
6	ANODE B
7	ANODE A
8	COMMON CATHODE
9	ANODE F
10	ANODE G

## Internal Circuit Diagram (Common Anode)

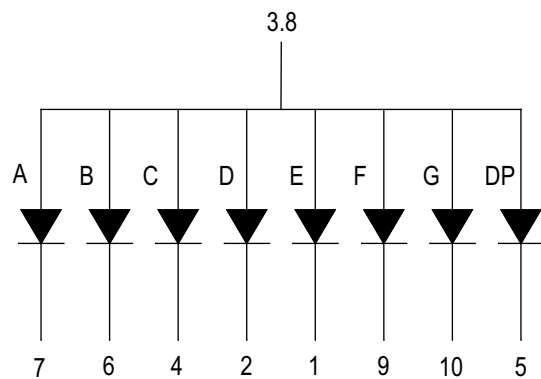

## Internal Circuit Diagram (Common Cathode)

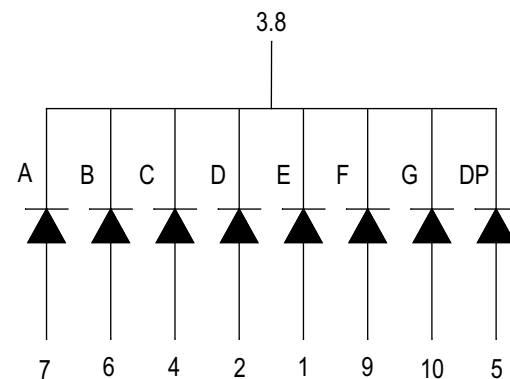

## Absolute Maximum Ratings at $T_A = 25^\circ\text{C}$

Parameter	Green/Yellow/Red/Orange	Units
Power Dissipation Per Segment	65	mW
Peak Forward Current Per Segment (1/10 Duty Cycle, 0.1-ms pulse width)	100	mA
Continuous Forward Current Per Segment	25	mA
Derating Linearly From 25°C Per Segment	0.25	mA/°C
Reverse Voltage Per Segment	Not designed for reverse bias operation	
Operating Temperature Range	-40°C to +105°C	
Storage Temperature Range	-40°C to +105°C	

## Electrical/Optical Characteristics at $T_A = 25^\circ\text{C}$

### Green

Parameters	Symbol	Min.	Typ.	Max.	Units	Test Condition
Average Luminous Intensity <sup>a, b, c</sup>	$I_V$	5.4	10.5	—	mcd	$I_F = 10\text{ mA}$
Emissions Wavelength <sup>d</sup>	$\lambda_p/\lambda_d$	—	572/571	—	nm	$I_F = 20\text{ mA}$
Spectral Line Half-Width	$\Delta\lambda$	—	20	—	nm	$I_F = 20\text{ mA}$
Forward Voltage, Per Segment <sup>e</sup>	$V_F$	—	2.1	2.6	V	$I_F = 20\text{ mA}$
Reverse Current, Per Segment <sup>f</sup>	$I_R$	—	—	100	$\mu\text{A}$	$V_R = 5\text{V}$
Luminous Intensity Matching Ratio	$I_{V-M}$	—	—	2:1		$I_F = 10\text{ mA}$

- The luminous intensity,  $I_V$ , is measured at the mechanical axis of the package.
- The optical axis is closely aligned with the mechanical axis of the package.
- Tolerance is  $\pm 15\%$ .
- The dominant wavelength,  $\lambda_d$ , is derived from the CIE Chromaticity Diagram and represents the perceived color of the device.
- Forward voltage tolerance is  $\pm 0.1\text{V}$ .
- Indicates product final test condition. Long-term reverse bias is not recommended.

### Yellow

Parameters	Symbol	Min.	Typ.	Max.	Units	Test Condition
Average Luminous Intensity <sup>a, b, c</sup>	$I_V$	8.6	20	—	mcd	$I_F = 10\text{ mA}$
Emissions Wavelength <sup>d</sup>	$\lambda_p/\lambda_d$	—	591/589	—	nm	$I_F = 20\text{ mA}$
Spectral Line Half-Width	$\Delta\lambda$	—	15	—	nm	$I_F = 20\text{ mA}$
Forward Voltage, Per Segment <sup>e</sup>	$V_F$	—	2.1	2.6	V	$I_F = 20\text{ mA}$
Reverse Current, Per Segment <sup>f</sup>	$I_R$	—	—	100	$\mu\text{A}$	$V_R = 5\text{V}$
Luminous Intensity Matching Ratio	$I_{V-M}$	—	—	2:1		$I_F = 10\text{ mA}$

- The luminous intensity,  $I_V$ , is measured at the mechanical axis of the package.
- The optical axis is closely aligned with the mechanical axis of the package.
- Tolerance is  $\pm 15\%$ .
- The dominant wavelength,  $\lambda_d$ , is derived from the CIE Chromaticity Diagram and represents the perceived color of the device.
- Forward voltage tolerance is  $\pm 0.1\text{V}$ .
- Indicates product final test condition. Long-term reverse bias is not recommended.

## Red

Parameters	Symbol	Min.	Typ.	Max.	Units	Test Condition
Average Luminous Intensity <sup>a, b, c</sup>	$I_V$	8.6	16	—	mcd	$I_F = 10 \text{ mA}$
Emissions Wavelength <sup>d</sup>	$\lambda_p/\lambda_d$	—	644/630	—	nm	$I_F = 20 \text{ mA}$
Spectral Line Half-Width	$\Delta\lambda$	—	20	—	nm	$I_F = 20 \text{ mA}$
Forward Voltage, Per Segment <sup>e</sup>	$V_F$	—	2.0	2.6	V	$I_F = 20 \text{ mA}$
Reverse Current, Per Segment <sup>f</sup>	$I_R$	—	—	100	$\mu\text{A}$	$V_R = 5\text{V}$
Luminous Intensity Matching Ratio	$I_{V-M}$	—	—	2:1		$I_F = 10 \text{ mA}$

- The luminous intensity,  $I_V$ , is measured at the mechanical axis of the package.
- The optical axis is closely aligned with the mechanical axis of the package.
- Tolerance is  $\pm 15\%$ .
- The dominant wavelength,  $\lambda_d$ , is derived from the CIE Chromaticity Diagram and represents the perceived color of the device.
- Forward voltage tolerance is  $\pm 0.1\text{V}$ .
- Indicates product final test condition. Long-term reverse bias is not recommended.

## Orange

Parameters	Symbol	Min.	Typ.	Max.	Units	Test Condition
Average Luminous Intensity <sup>a, b, c</sup>	$I_V$	8.6	19.5	—	mcd	$I_F = 10 \text{ mA}$
Emissions Wavelength <sup>d</sup>	$\lambda_p/\lambda_d$	—	611/605	—	nm	$I_F = 20 \text{ mA}$
Spectral Line Half-Width	$\Delta\lambda$	—	17	—	nm	$I_F = 20 \text{ mA}$
Forward Voltage, Per Segment <sup>e</sup>	$V_F$	—	2.1	2.6	V	$I_F = 20 \text{ mA}$
Reverse Current, Per Segment <sup>f</sup>	$I_R$	—	—	100	$\mu\text{A}$	$V_R = 5\text{V}$
Luminous Intensity Matching Ratio	$I_{V-M}$	—	—	2:1		$I_F = 10 \text{ mA}$

- The luminous intensity,  $I_V$ , is measured at the mechanical axis of the package.
- The optical axis is closely aligned with the mechanical axis of the package.
- Tolerance is  $\pm 15\%$ .
- The dominant wavelength,  $\lambda_d$ , is derived from the CIE Chromaticity Diagram and represents the perceived color of the device.
- Forward voltage tolerance is  $\pm 0.1\text{V}$ .
- Indicates product final test condition. Long-term reverse bias is not recommended.

# Typical Electrical/Optical Characteristic Curves at $T_A = 25^\circ\text{C}$

## Green

Figure 1: Relative Luminous Intensity vs. Wavelength

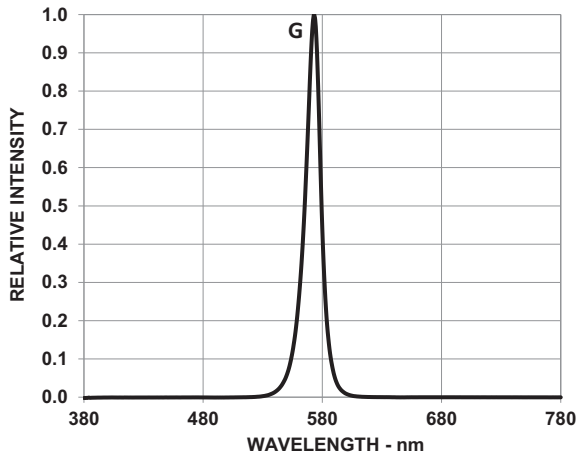

Figure 2: Relative Luminous Intensity vs. Forward Current

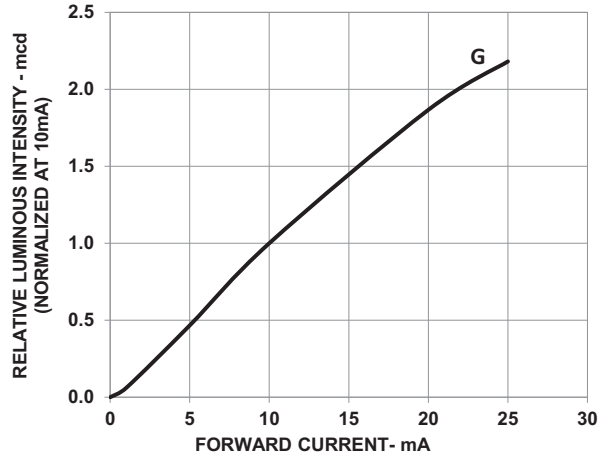

Figure 3: Allowable DC Current vs. Ambient Temperature

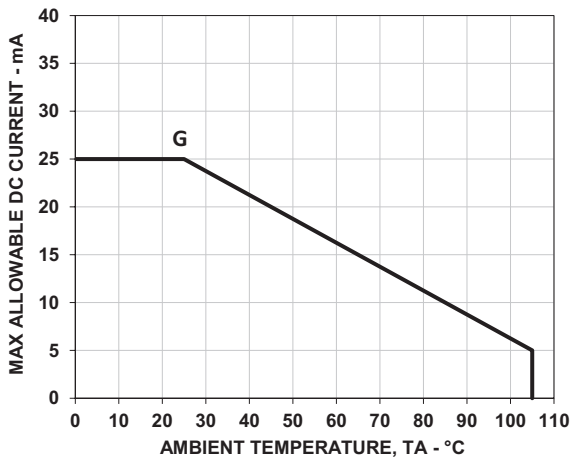
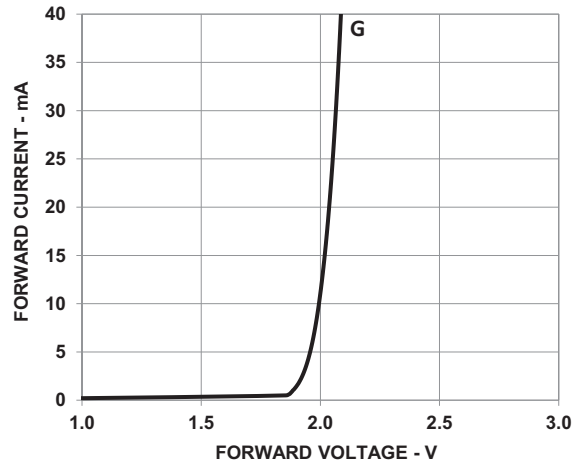

Figure 4: Forward Current vs. Forward Voltage



# Yellow

Figure 5: Relative Intensity vs. Wavelength

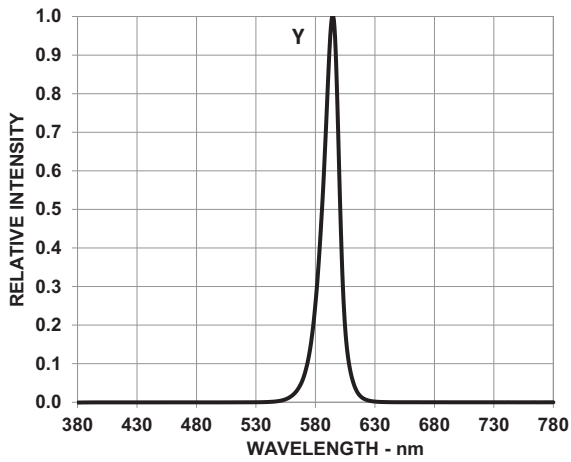

Figure 6: Relative Intensity vs. Forward Current

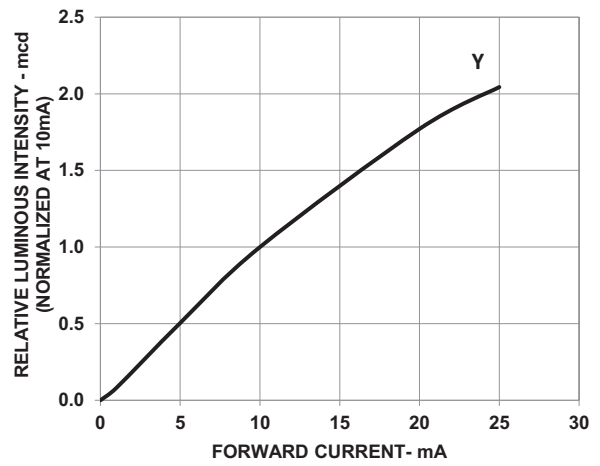

Figure 7: Allowable DC Current vs. Ambient Temperature

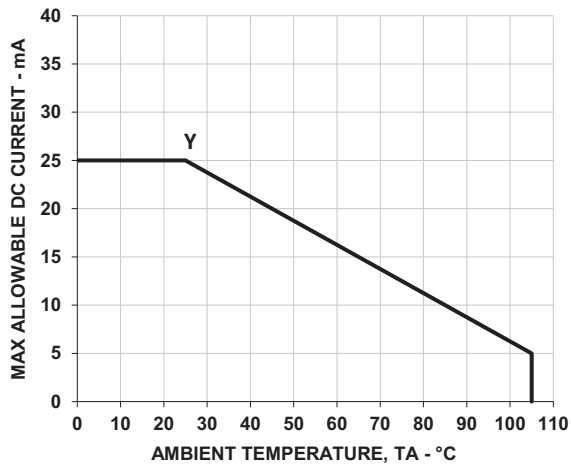
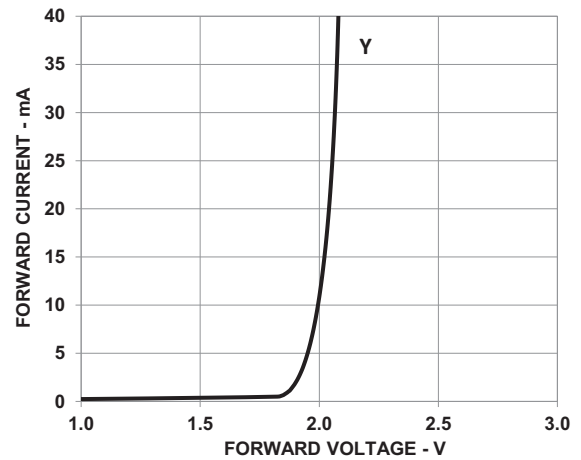

Figure 8: Forward Current vs. Forward Voltage



# Red

Figure 9: Relative Luminous Intensity vs. Wavelength

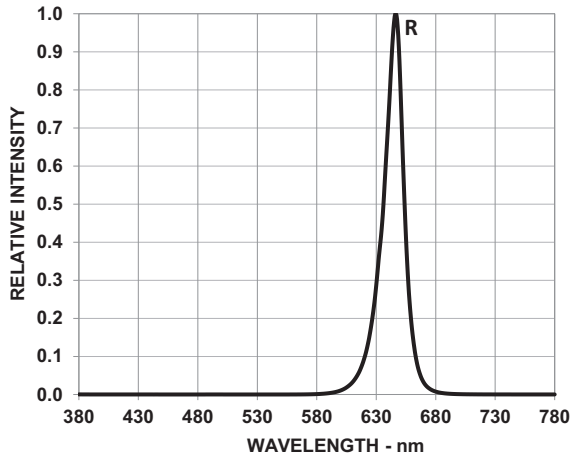

Figure 10: Relative Luminous Intensity vs. Forward Current

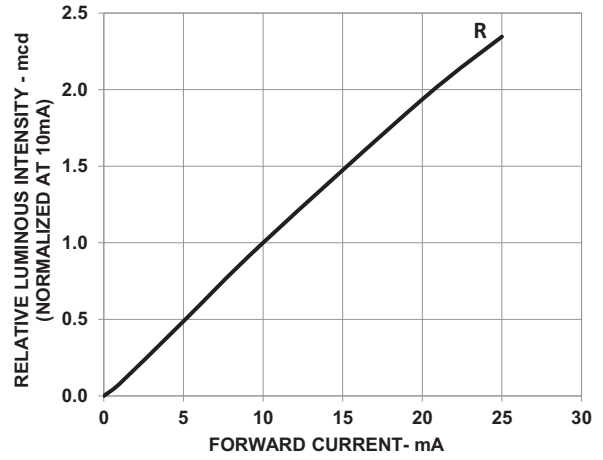

Figure 11: Allowable DC Current vs. Ambient Temperature

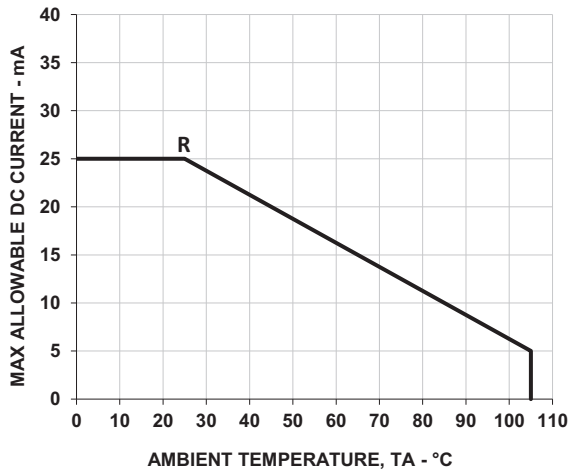
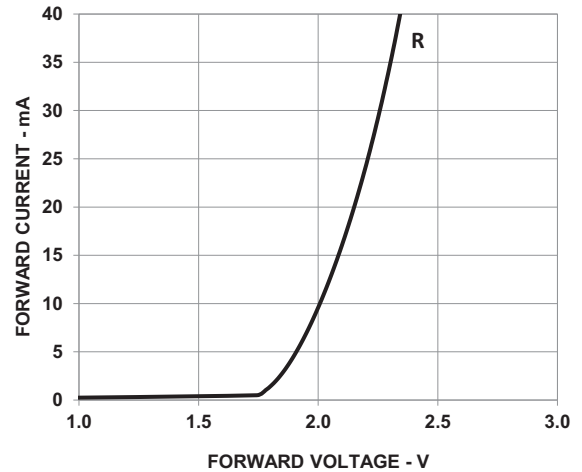

Figure 12: Forward Current vs. Forward Voltage





# Orange

Figure 13: Relative Intensity vs. Wavelength

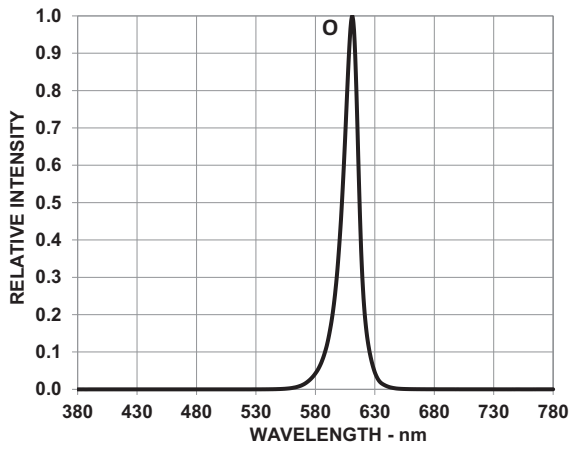

Figure 14: Relative Intensity vs. Forward Current

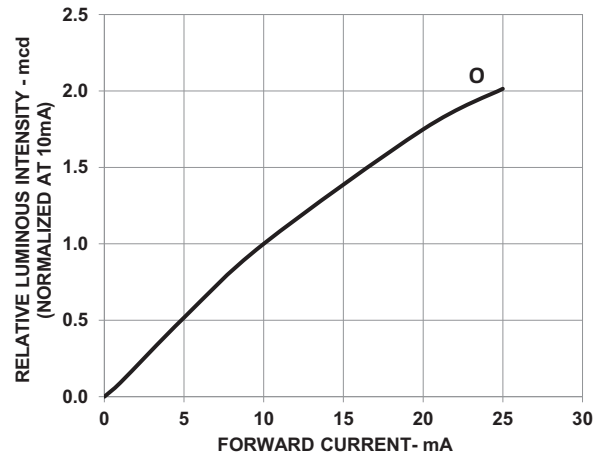

Figure 15: Allowable DC Current vs. Ambient Temperature

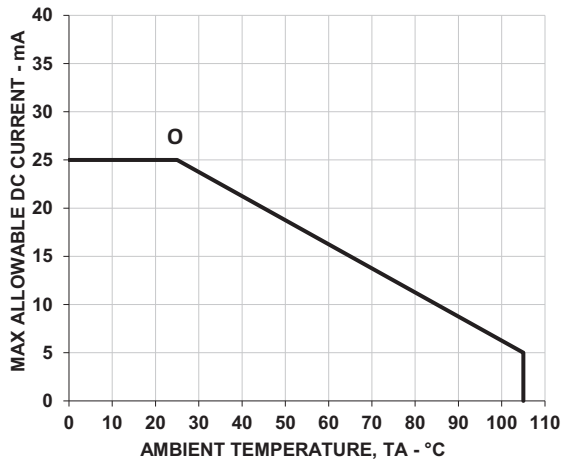
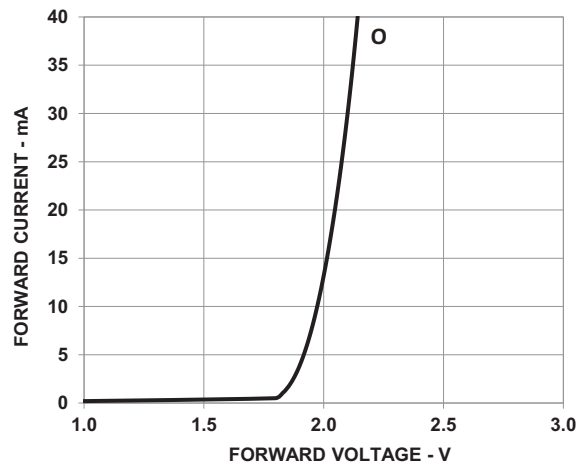

Figure 16: Forward Current vs. Forward Voltage



## Intensity Bin Limits (mcd)

### Green

IV Bin Category	Min.	Max.
M	5.401	8.600
N	8.601	13.700
P	13.701	21.800
Q	21.801	37.400

Tolerance:  $\pm 15\%$ .

**NOTE:** Bin categories are established for classification of products. Products may not be available in all categories. Contact your Broadcom representative for information on currently available bins.

### Yellow/Red/Orange

IV Bin Category	Min.	Max.
N	8.601	13.700
P	13.701	21.800
Q	21.801	34.700
R	34.701	55.200

Tolerance:  $\pm 15\%$ .

## SMT Soldering Profile

### Pb-Free Reflow Soldering Profile

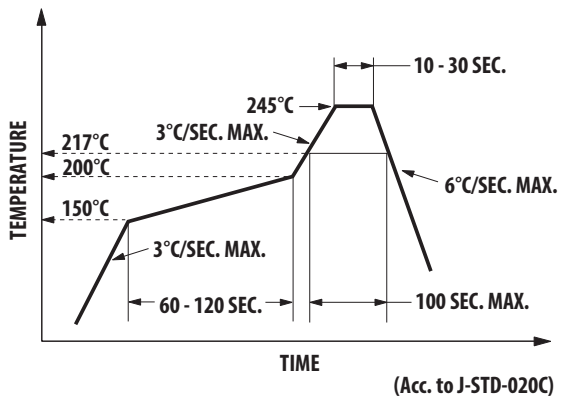

#### NOTE:

1. The peak temperature refers to the peak package body temperature.
2. The number of reflow processes shall be limited to a maximum of twice only. A cooling process to normal temperature is required between the first and second soldering processes.

### Recommended Soldering Pattern (unit: mm)

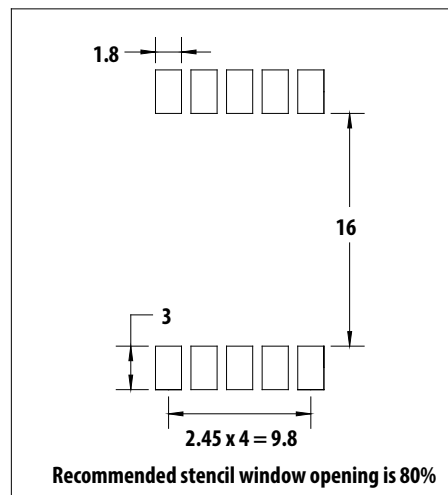

# Tape Specification (unit: mm)

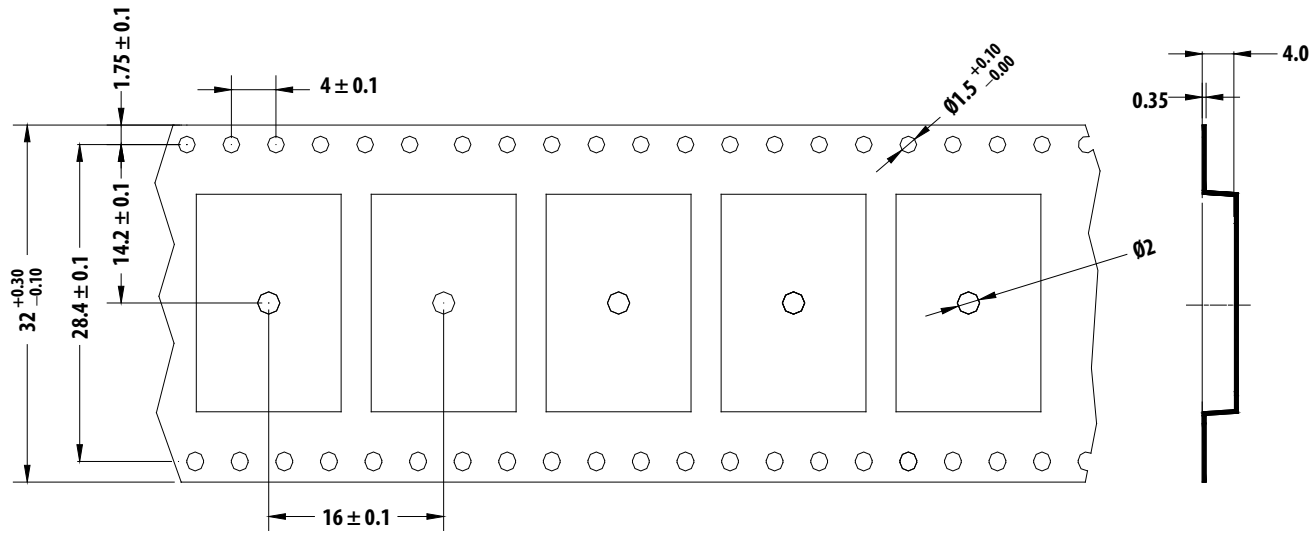

## Precautionary Notes

### Soldering

- Do not perform reflow soldering more than twice. Allow the product to cool to normal room temperature before the second reflow. Observe the necessary precautions of handling moisture-sensitive devices as stated in the following section.
- Do not apply any pressure or force on the LED display during reflow and after reflow when it is still hot.
- Use reflow soldering to solder the LED display. Use hand soldering only for rework if unavoidable, but it must be strictly controlled to the following conditions:
  - Soldering iron tip temperature = 315°C maximum
  - Soldering duration = 2 seconds maximum
  - Number of cycles = 1 only
  - Power of soldering iron = 50W maximum
- Do not touch the LED display with the soldering iron except for the soldering terminals, as it may cause damage.
- Confirm beforehand whether the functionality and performance of the LED display is affected by soldering with hand soldering.
- Use solder paste with no-clean flux for soldering.
- To remove foreign particles on the surface of the package, use a wet cotton bud with isopropyl alcohol (IPA). During cleaning, rub the surface gently without putting too much pressure. Do not wash or soak the LED display in any solution.

### Handling of Moisture-Sensitive Devices

This product has a Moisture Sensitive Level 3 rating per JEDEC J-STD-020. Refer to Broadcom Application Note AN5305, *Handling of Moisture Sensitive Surface Mount Devices*, for additional details and a review of proper handling procedures.

- Before use:
  - An unopened moisture barrier bag (MBB) can be stored at <40°C/90% RH for 12 months. If the actual shelf life has exceeded 12 months and the humidity indicator card (HIC) indicates that baking is not required, it is safe to reflow the LED displays per the original MSL rating.
  - Do not open the MBB prior to assembly (for example, for IQC). If unavoidable, the MBB must be properly resealed with fresh desiccant and an HIC. The exposed duration must be taken in as floor life.

- Control after opening the MBB:
  - Read the HIC immediately upon opening the MBB.
  - Keep the LEDs at <30°C/60% RH at all times, and complete all high-temperature related processes, including soldering, curing, or rework within 168 hours.
- Control for unfinished reel:
 

Store unused LEDs in a sealed MBB with desiccant or a desiccator at <5% RH.
- Control of assembled boards:
 

If the PCB soldered with the LED displays is to be subjected to other high-temperature processes, store the PCB in a sealed MBB with desiccant or desiccator at <5% RH to ensure that all LED displays have not exceeded their floor life of 168 hours.
- Baking is required if one of the following conditions exist:
  - The HIC indicator indicates a change in color for 10% and 5%, as stated on the HIC.
  - The LED displays are exposed to conditions of >30°C/60% RH at any time.
  - The LED's floor life exceeded 168 hours.

The recommended baking condition is: 60°C ± 5°C for 20 hours.

Baking can only be done once.

### Application Precautions

- The drive current of the LED display must not exceed the maximum allowable limit across temperature as stated in the data sheet. Constant current driving is recommended to ensure consistent performance.
- Circuit design must cater to the whole range of forward voltage ( $V_F$ ) of the LED display to ensure the intended drive current can always be achieved.
- The LED display exhibits slightly different characteristics at different drive currents, which may result in a larger variation of performance (such as intensity, wavelength, and forward voltage). Set the application current as close as possible to the test current to minimize these variations.
- The LED is not intended for reverse bias. Use other appropriate components for such purposes. When driving the LED in matrix form, ensure that the reverse bias voltage does not exceed the allowable limit of the LED.

- Avoid rapid changes in ambient temperature, especially in high-humidity environments, because they cause condensation on the LED display.
- If the LED display is intended to be used in harsh or outdoor environment, protect the LED against damages caused by rain, water, dust, oil, corrosive gases, external mechanical stresses, and so on.

Broadcom, the pulse logo, Connecting everything, Avago Technologies, Avago, and the A logo are among the trademarks of Broadcom and/or its affiliates in the United States, certain other countries, and/or the EU.

Copyright © 2011–2021 Broadcom. All Rights Reserved.

The term “Broadcom” refers to Broadcom Inc. and/or its subsidiaries. For more information, please visit [www.broadcom.com](http://www.broadcom.com).

Broadcom reserves the right to make changes without further notice to any products or data herein to improve reliability, function, or design. Information furnished by Broadcom is believed to be accurate and reliable. However, Broadcom does not assume any liability arising out of the application or use of this information, nor the application or use of any product or circuit described herein, neither does it convey any license under its patent rights nor the rights of others.

