

REVISIONS					
REV	ECO	DESCRIPTION	DATE	BY	APPR
A1	-	RELEASE NEW DRAWING	11APR18	ROOKIE	TOMMY
A2	-	REVISED DESCRIPTION	12JUN19	JAH	DH
A3	-	UPDATE THE APPEARANCE	11NOV21	RONALD	TOMMY

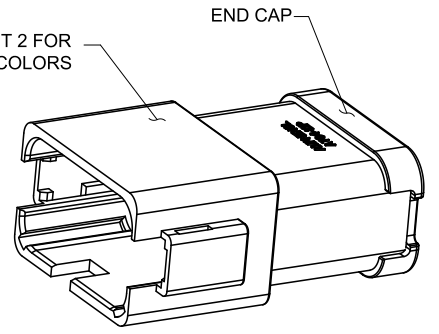
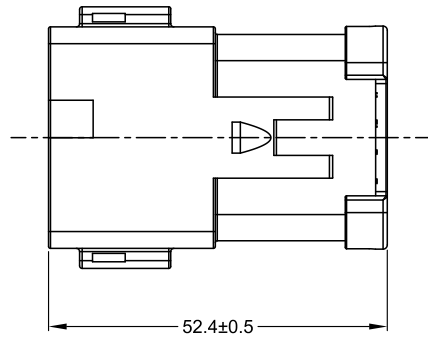
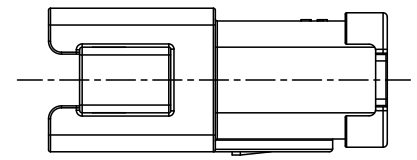
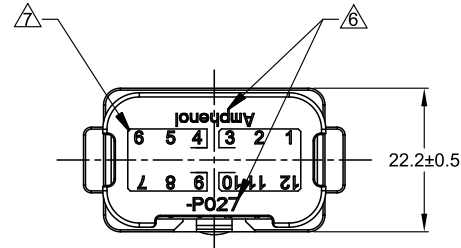
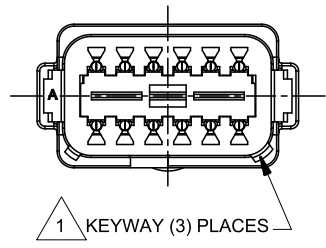
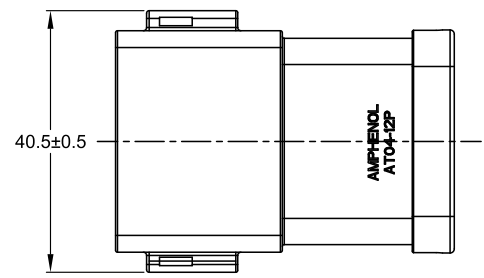

NOTES: UNLESS OTHERWISE SPECIFIED

△ SEE SHEET 2 FOR KEY ARRANGEMENTS AND COLORS.

2. MATERIAL:

HOUSING: THERMOPLASTIC
SEAL: SILICONE RUBBER
CONTACT: COPPER ALLOY

3. MODIFICATIONS: 2 PIECES OF 6 PIN BUSBAR WITH GOLD PLATED

4. SPECIFICATIONS:

- 4.1 CURRENT RATING: 39 AMPS MAXIMUM FOR THE 6 PIN BUSBAR
- 4.2 OPERATING TEMPERATURE: -55°C TO +125°C.
- 4.3 DIELECTRIC WITHSTANDING VOLTAGE: LESS THAN 2 MILLIAMPS CURRENT LEAKAGE @ 1500 VOLTS AC.
- 4.4 INSULATION RESISTANCE: 1000 MEGOHM MIN @ 25°C.
- 4.5 MOISTURE RESISTANCE: IP69K & IP68 (1M OF WATER FOR A PERIOD OF 24 HOURS, MATED CONDITION)
- 4.6 MATING CYCLE DURABILITY: 100 CYCLES
- 4.7 RoHS COMPLIANT

5. MATING PART: AT06-12SX* PLUG

(X=A,B,C,D KEYS * = AVAILABLE MODIFICATIONS)

△ ORIENTATION OF "Amphenol" AND "-P027" TO BE OPTIONAL

△ BORDERS SIGNIFY THAT PINS 1,2,3,10,11,12 AND PINS 4,5,6,7,8,9 ARE BUSSED TOGETHER WITH 6 PIN BUSBARS

8. ALL DIMENSIONS ARE FOR REFERENCE USE ONLY.

SEE SHEET 2		REF: DT04-12PA-P027&DT04-12PB-P027			
PART NUMBER		DESCRIPTION		ITEM	
QUANTITY		MATERIALS LIST			
UNLESS OTHERWISE SPECIFIED 1) All dimensions are in metric (mm). 2) Tolerances are as follows: 1 PL DEC ±0.30 Fractions ±1/64 2 PL DEC ±0.15 Angles ±1° 3 PL DEC ±0.08		SIGNATURES		DATE	
		DRAWN: RONALD		11NOV21	
		CHECKED: ORION		12NOV21	
		APPROVAL: TOMMY		15NOV21	
MATERIAL SPECIFICATIONS: WEIGHT: 28.1g		CUSTOMER:		Amphenol	
PROCESS SPECIFICATIONS:		THIS DRAWING IS SUPPLIED FOR INFORMATION ONLY. DESIGN FEATURES, SPECIFICATIONS AND PERFORMANCE DATA SHOWN HEREON ARE THE PROPERTY OF THE AMPHENOL CORPORATION. NO RIGHTS OF REPRODUCTION ARE IMPLIED. ALL DIMENSIONS ARE SUBJECT TO NORMAL MANUFACTURING VARIATIONS.		Sine Systems - www.amphenol-sine.com 44724 Morley Drive Clinton Township, MI 48036	
NEXT ASSY:		SIZE: B C-		DWG NO: AT04-12PX-P027	
		SCALE: NONE		REVISION: A3	
				SHEET 1 OF 2	

TITLE: HYPERBUSS AT 12WAY RECP (2)6 PIN BUSBAR GOLD-PLATED
DWG NO: AT04-12PX-P027
REV: A3
SH: 1
OF: 2

REVISIONS					
REV	ECO	DESCRIPTION	DATE	BY	APPR
A1	-	RELEASE NEW DRAWING	11APR18	ROOKIE	TOMMY
A2	-	REVISED DESCRIPTION	12JUN19	JAH	DH
A3	-	UPDATE THE APPEARANCE	11NOV21	RONALD	TOMMY

P/N AT04-12PA-P027
KEY-A CONFIGURATION
STANDARD COLOR: GREY

P/N AT04-12PB-P027
KEY-B CONFIGURATION
STANDARD COLOR: BLACK

P/N AT04-12PC-P027
KEY-C CONFIGURATION
STANDARD COLOR: GREEN

P/N AT04-12PD-P027
KEY-D CONFIGURATION
STANDARD COLOR: BROWN

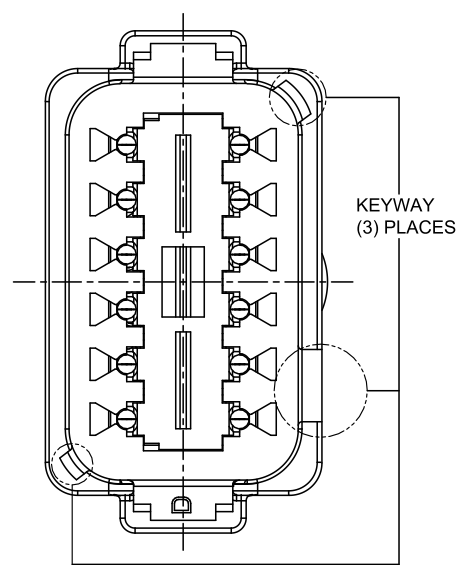
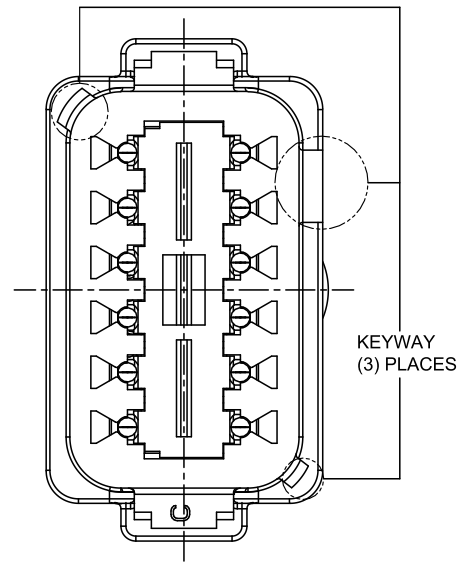
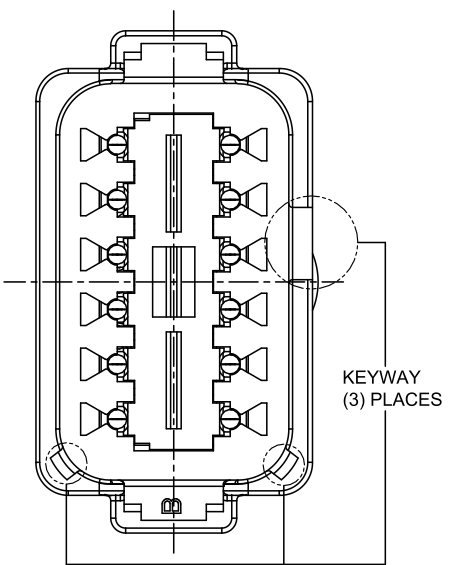
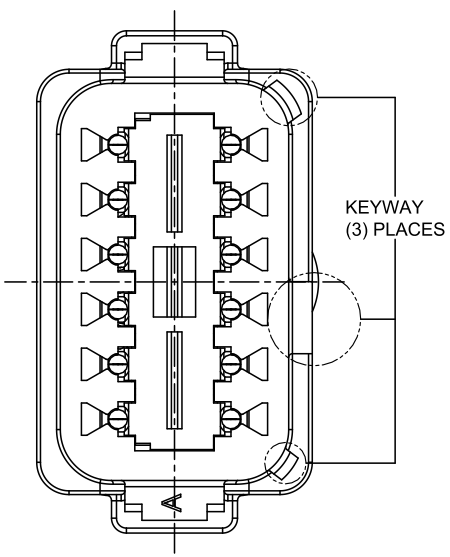

TITLE: HYPERBUSS AT 12WAY RECP (2)6 PIN BUSBAR GOLD-PLATED
DWG NO: AT04-12PX-P027
REV: A3
SH: 2
OF: 2

QUANTITY	PART NUMBER	DESCRIPTION	ITEM										
MATERIALS LIST													
<small>UNLESS OTHERWISE SPECIFIED</small> 1) All dimensions are in metric(mm). 2) Tolerances are as follows: 1 PL DEC ±0.30 Fractions ±1/64 2 PL DEC ±0.15 Angles ±1° 3 PL DEC ±0.08 3) Note reference =		<table border="1"> <thead> <tr> <th>SIGNATURES</th> <th>DATE</th> </tr> </thead> <tbody> <tr> <td>DRAWN: RONALD</td> <td>11NOV21</td> </tr> <tr> <td>CHECKED: ORION</td> <td>12NOV21</td> </tr> <tr> <td>ENGINEER:</td> <td></td> </tr> <tr> <td>APPROVAL: TOMMY</td> <td>15NOV21</td> </tr> </tbody> </table>		SIGNATURES	DATE	DRAWN: RONALD	11NOV21	CHECKED: ORION	12NOV21	ENGINEER:		APPROVAL: TOMMY	15NOV21
SIGNATURES	DATE												
DRAWN: RONALD	11NOV21												
CHECKED: ORION	12NOV21												
ENGINEER:													
APPROVAL: TOMMY	15NOV21												
MATERIAL SPECIFICATIONS: WEIGHT: 28.1g		<h1>Amphenol</h1> <p>Sine Systems - www.amphenol-sine.com 44724 Morley Drive Clinton Township, MI 48036</p>											
PROCESS SPECIFICATIONS: NEXT ASSY:		THIS DRAWING IS SUPPLIED FOR INFORMATION ONLY. DESIGN FEATURES, SPECIFICATIONS AND PERFORMANCE DATA SHOWN HEREON ARE THE PROPERTY OF THE AMPHENOL CORPORATION. NO RIGHTS OF REPRODUCTION ARE IMPLIED. ALL DIMENSIONS ARE SUBJECT TO NORMAL MANUFACTURING VARIATIONS.											
		SIZE: B C- SCALE: NONE	DWG NO: AT04-12PX-P027 REVISION: A3 SHEET 2 OF 2										