

Surface Mount SILICON ZENER DIODES

Zener Voltage 3.3 to 200 Volts 3 Watt Power Dissipation

FEATURES

- * Glass passivated chip
- * Built-in strain relief
- * Low inductance
- * High peak reverse power dissipation
- * Low reverse leakage
- * For use in stabilizing and clipping with high power rating
- * ESD Rating of Class 3 (> 20 kV) per Human Body Model

MECHANICAL DATA

- * Epoxy: Device has UL flammability classification 94V-0
- * Lead: Solderable per MIL-STD-750, method 2026

MAXIMUM RATINGS AND ELECTRICAL CHARACTERISTICS

Ratings at 25 °C ambient temperature unless otherwise specified.
Resistive or inductive load.



SMB

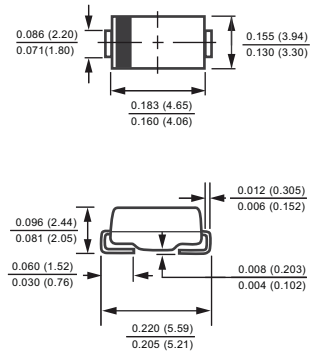

Dimensions in inches and (millimeters)

Absolute Maximum Ratings (Ta = 25°C)

Parameter	Symbol	Rating	Unit
Power dissipation @ TL = 75°C	P	3000	mW
Thermal Resistance, Junction to Lead	R θ JL	25	°C/W
Maximum forward voltage at if=200mA	VF	1.2	V
Peak Forward Surge Current 8.3 ms single half sine-wave superimposed on rated load (JEDEC method)	IFSM	50	A
Typical Current Square Time	I ² T	10.37	A ² S
Storage temperature and Junction temperature	Tstg , Tj	-55 to +150	°C

RATING AND CHARACTERISTICS CURVES (1SMB5913B THRU 1SMB5956B)

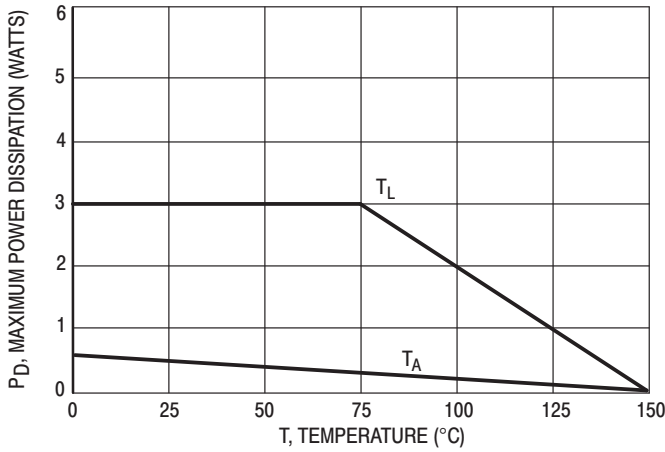

Figure 1. Steady State Power Derating

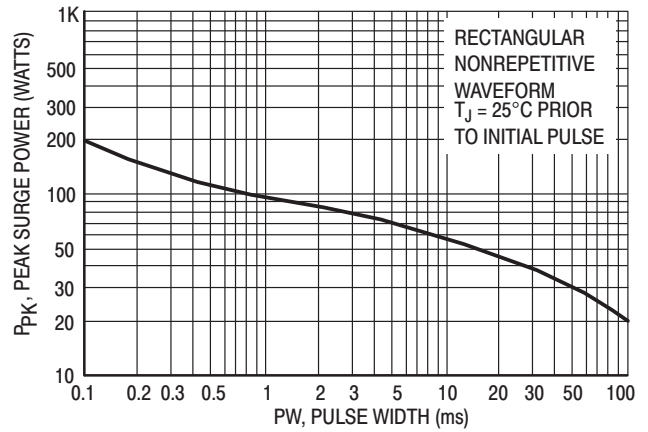

Figure 2. Maximum Surge Power

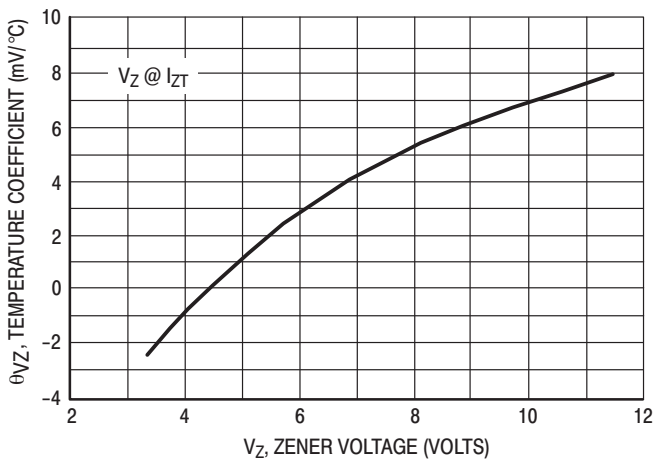

Figure 3. Zener Voltage - To 12 Volts

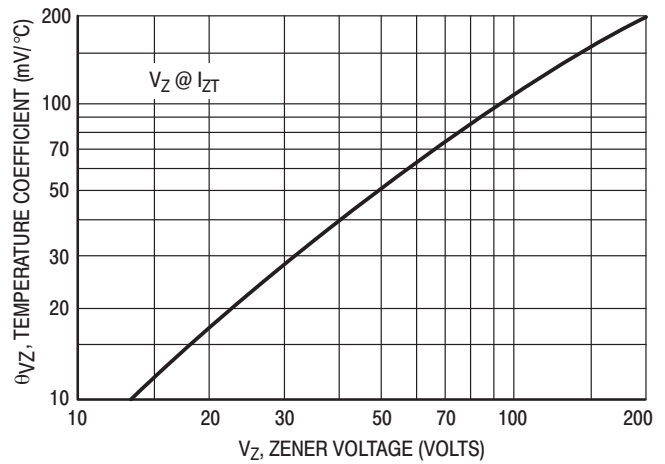

Figure 4. Zener Voltage - 14 To 200 Volts

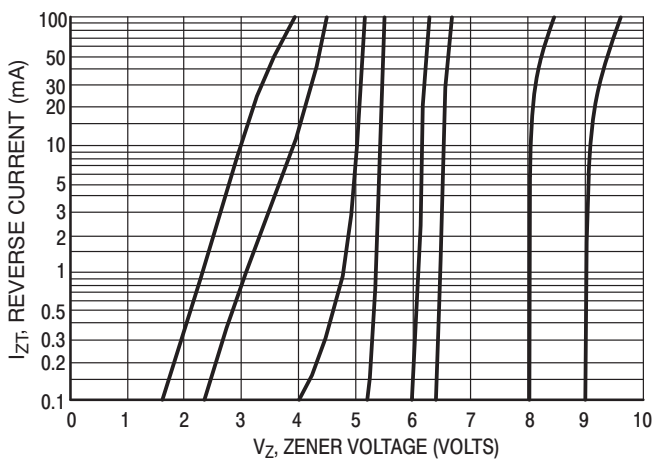

Figure 5. $V_Z = 3.3$ thru 10 Volts

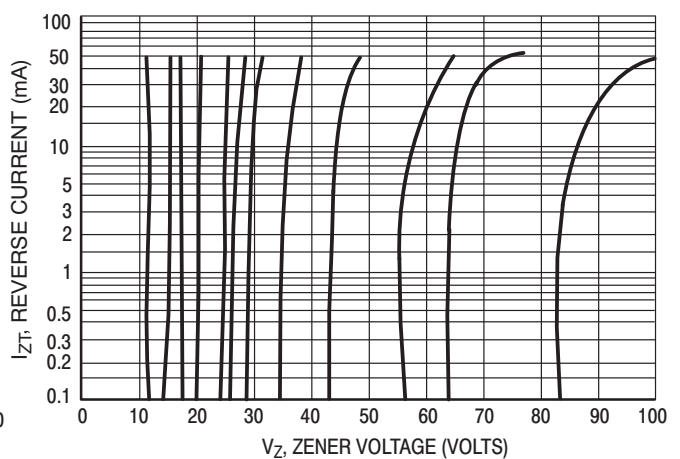

Figure 6. $V_Z = 12$ thru 82 Volts

RATING AND CHARACTERISTICS CURVES (1SMB5913B THRU 1SMB5956B)

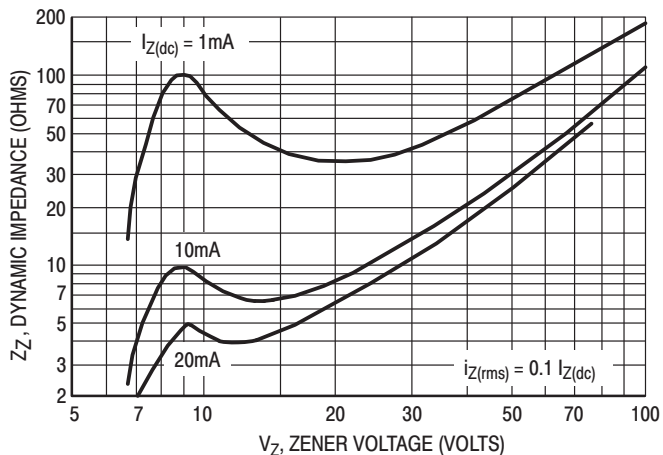

Figure 7. Effect of Zener Voltage

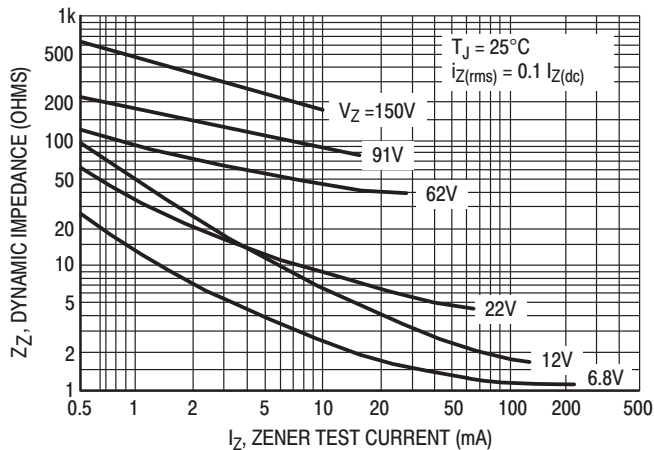

Figure 8. Effect of Zener Current

Rating and Typical Characteristic Curves ($T_A = 25^\circ C$)

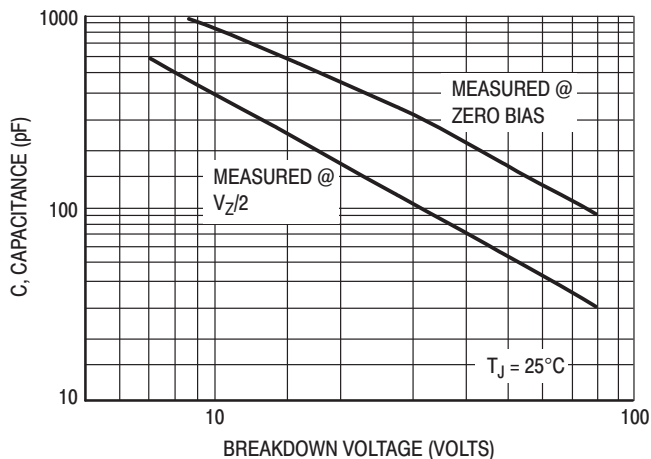

Figure 9. Capacitance Curve

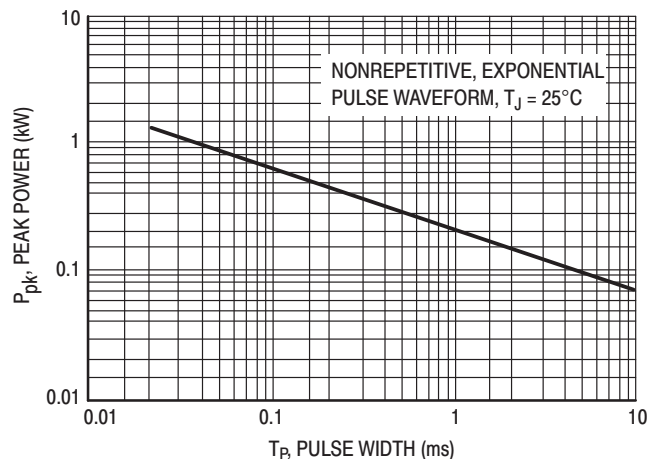

Figure 10. Typical Pulse Rating Curve

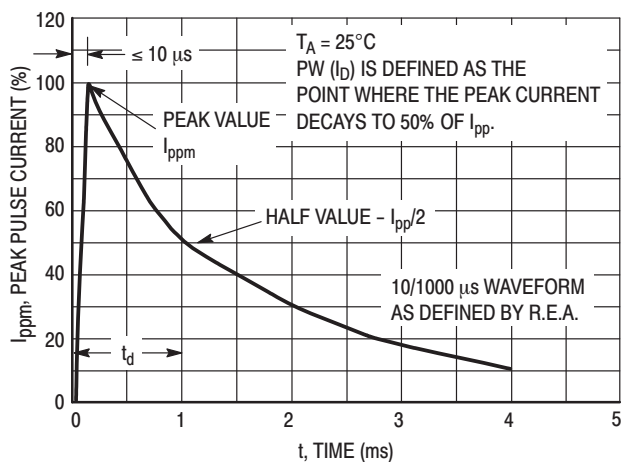

Figure 11. Pulse Waveform

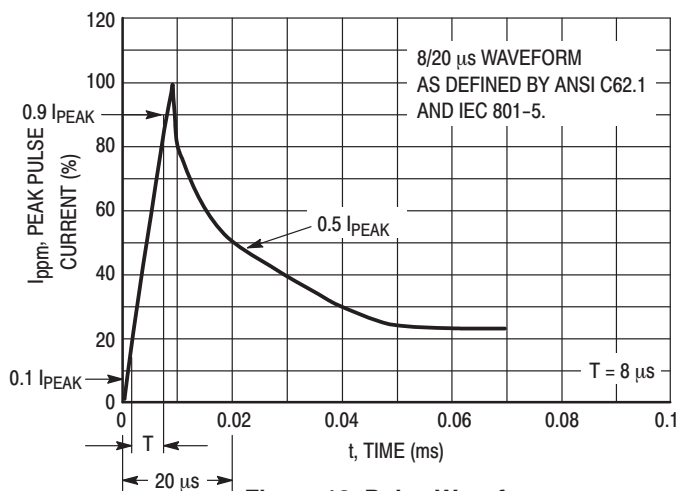
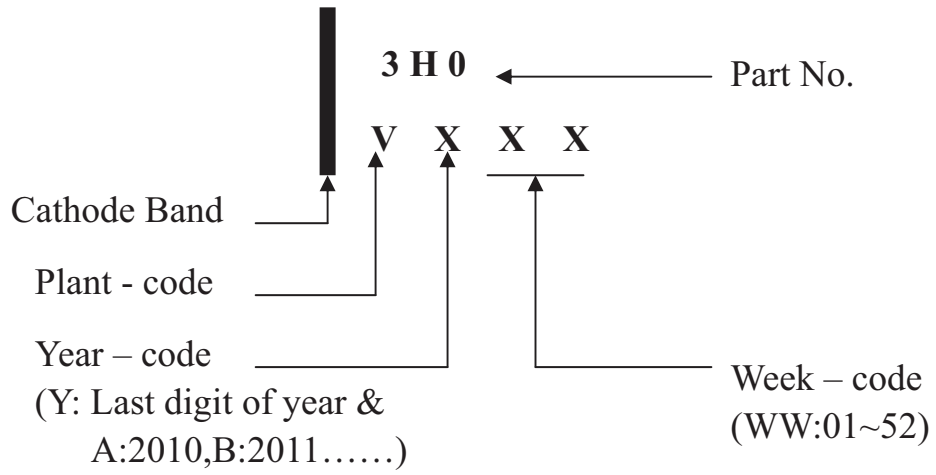

Figure 12. Pulse Waveform

Part Number	Device Marking	Zener Voltage			Zener Impedance				Leakage Current		I _{ZM} mA(dc)
		V _Z (V)			Z _{zt} @I _{zt}		Z _{zk} @I _{zk}		I _R @V _R		
		Min	Nom	Max	Ω	mA	Ω	mA	uA	V	
1SMB5913B	3H0	3.13	3.3	3.47	10	113.6	500	1	100	1	454
1SMB5914B	3H1	3.42	3.6	3.78	9	104.2	500	1	75	1	416
1SMB5915B	3H2	3.7	3.9	4.1	7.5	96.1	500	1	25	1	384
1SMB5916B	3H3	4.08	4.3	4.52	6	87.2	500	1	5	1	348
1SMB5917B	3H4	4.46	4.7	4.94	5	79.8	500	1	5	1.5	319
1SMB5918B	3H5	4.84	5.1	5.36	4	73.5	350	1	5	2	294
1SMB5919B	3H6	5.32	5.6	5.88	2	66.9	250	1	5	3	267
1SMB5920B	3A0	5.89	6.2	6.51	2	60.5	200	1	5	4	241
1SMB5921B	3A1	6.46	6.8	7.14	2.5	55.1	200	1	5	5.2	220
1SMB5922B	3A2	7.12	7.5	7.88	3	50	400	0.5	5	6	200
1SMB5923B	3A3	7.79	8.2	8.61	3.5	45.7	400	0.5	5	6.5	182
1SMB5924B	3A4	8.64	9.1	9.56	4	41.2	500	0.5	5	7	164
1SMB5925B	3A5	9.5	10	10.5	4.5	37.5	500	0.25	5	8	150
1SMB5926B	3A6	10.45	11	11.55	5.5	34.1	550	0.25	1	8.4	136
1SMB5927B	3A7	11.4	12	12.6	6.5	31.2	550	0.25	1	9.1	125
1SMB5928B	3A8	12.35	13	13.65	7	28.8	550	0.25	1	9.9	115
1SMB5929B	3B0	14.25	15	15.75	9	25	600	0.25	1	11.4	100
1SMB5930B	3B1	15.2	16	16.8	10	23.4	600	0.25	1	12.2	93
1SMB5931B	3B3	17.1	18	18.9	12	20.8	650	0.25	1	13.7	83
1SMB5932B	3B5	19	20	21	14	18.7	650	0.25	1	15.2	75
1SMB5933B	3B6	20.9	22	23.1	17.5	17	650	0.25	1	16.7	68
1SMB5934B	3B7	22.8	24	25.2	19	15.6	700	0.25	1	18.2	62
1SMB5935B	3B8	25.65	27	28.35	23	13.9	700	0.25	1	20.6	55
1SMB5936B	3B9	28.5	30	31.5	28	12.5	750	0.25	1	22.8	50
1SMB5937B	3C0	31.35	33	34.65	33	11.4	800	0.25	1	25.1	45
1SMB5938B	3C1	34.2	36	37.8	38	10.4	850	0.25	1	27.4	41
1SMB5939B	3C2	37.05	39	40.95	45	9.6	900	0.25	1	29.7	38
1SMB5940B	3C3	40.85	43	45.15	53	8.7	950	0.25	1	32.7	34
1SMB5941B	3C4	44.65	47	49.35	67	8	1000	0.25	1	35.8	31
1SMB5942B	3C5	48.45	51	53.55	70	7.3	1100	0.25	1	38.8	29
1SMB5943B	3C6	53.2	56	58.8	86	6.7	1300	0.25	1	42.6	26
1SMB5944B	3C7	58.9	62	65.1	100	6	1500	0.25	1	47.1	24
1SMB5945B	3C8	64.6	68	71.4	120	5.5	1700	0.25	1	51.7	22
1SMB5946B	3C9	71.25	75	78.75	140	5	2000	0.25	1	56	20
1SMB5947B	3F0	77.9	82	86.1	160	4.6	2500	0.25	1	62.2	18
1SMB5948B	3F1	86.45	91	95.55	200	4.1	3000	0.25	1	69.2	16
1SMB5949B	3F2	95	100	105	250	3.7	3100	0.25	1	76	15
1SMB5950B	3F3	104.5	110	115.5	300	3.4	4000	0.25	1	83.6	13
1SMB5951B	3F4	114	120	126	380	3.1	4500	0.25	1	91.2	12
1SMB5952B	3F5	123.5	130	136.5	450	2.9	5000	0.25	1	98.8	11
1SMB5953B	3F7	142.5	150	157.5	600	2.5	6000	0.25	1	114	10
1SMB5954B	3F8	152	160	168	700	2.3	6500	0.25	1	121.6	9
1SMB5955B	3G1	171	180	189	900	2.1	7000	0.25	1	136.8	8
1SMB5956B	3G3	190	200	210	1200	1.9	8000	0.25	1	152	7

Marking on the body



1. BOX

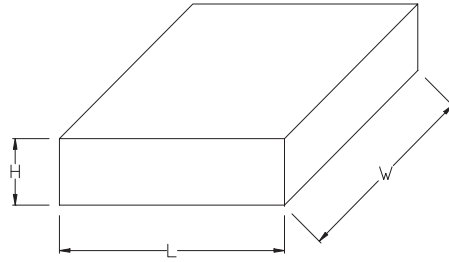

Packing Code	L (mm)	W (mm)	H (mm)
-W/-T	338	338	40

2. REEL

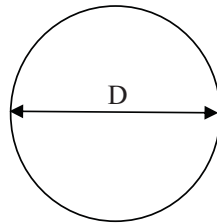

Packing Code	D (mm)
-W/-T	330

3. CARTON

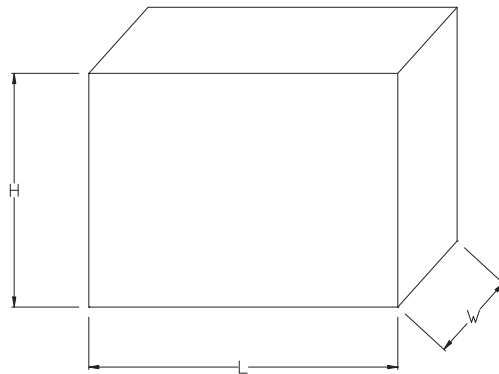

Packing Code	L (mm)	W (mm)	H (mm)
-W/-T	360	355	360

PACKAGING OF DIODE AND BRIDGE RECTIFIERS

REEL PACK

PACKAGE	PACKING CODE	EA PER REEL	EA PER INNER BOX	COMPONENT SPACE (mm)	TAPE SPACE (mm)	REEL DIA (mm)	CARTON SIZE (mm)	EA PER CARTON	GROSS WEIGHT(Kg)
SMB	-W/-T	3,000	6,000	---	---	330	360*355*360	48,000	13.90

DISCLAIMER NOTICE

Rectron Inc reserves the right to make changes without notice to any product specification herein, to make corrections, modifications, enhancements or other changes. Rectron Inc or anyone on its behalf assumes no responsibility or liability for any errors or inaccuracies. Data sheet specifications and its information contained are intended to provide a product description only. "Typical" parameters which may be included on RECTRON data sheets and/ or specifications can and do vary in different applications and actual performance may vary over time. Rectron Inc does not assume any liability arising out of the application or use of any product or circuit.

Rectron products are not designed, intended or authorized for use in medical, life-saving implant or other applications intended for life-sustaining or other related applications where a failure or malfunction of component or circuitry may directly or indirectly cause injury or threaten a life without expressed written approval of Rectron Inc. Customers using or selling Rectron components for use in such applications do so at their own risk and shall agree to fully indemnify Rectron Inc and its subsidiaries harmless against all claims, damages and expenditures.