

FEATURES

Fixed gain of 17.4 dB
Broadband operation from 30 MHz to 6 GHz
Input/output internally matched to 50 Ω
Integrated bias control circuit
OIP3 of 34.9 dBm at 900 MHz
P1dB of 17.6 dBm at 900 MHz
Noise figure of 2.9 dB at 900 MHz
Single 5 V power supply
Low quiescent current of 55 mA
Wide operating temperature range of -40°C to $+105^{\circ}\text{C}$
Thermally efficient SOT-89 package
ESD rating of ± 1.5 kV (Class 1C)

GENERAL DESCRIPTION

The [ADL5544](#) is a single-ended RF/IF gain block amplifier that provides broadband operation from 30 MHz to 6 GHz. The [ADL5544](#) provides over 34 dBm of OIP3 using only 55 mA from a 5 V supply.

The [ADL5544](#) provides a gain of 17 dB, which is stable over frequency, temperature, power supply, and from device to device. The amplifier is offered in the industry-standard SOT-89 package and is internally matched to 50 Ω at the input and output, making the [ADL5544](#) very easy to implement in a wide variety of applications. The only external components required are the input/output ac coupling capacitors, power supply decoupling capacitors, and dc bias inductor.

FUNCTIONAL BLOCK DIAGRAM

Figure 1.

The [ADL5544](#) is fabricated on an InGaP HBT process and has a high ESD rating of ± 1.5 kV (Class 1C). The [ADL5544](#) is also fully specified for operation across the wide temperature range of -40°C to $+105^{\circ}\text{C}$. A fully populated RoHS-compliant evaluation board is available.

TABLE OF CONTENTS

| | | | |
|--|---|---|----|
| Features | 1 | 100 MHz to 500 MHz Frequency Band | 10 |
| Functional Block Diagram | 1 | 4 GHz to 6 GHz Frequency Band | 11 |
| General Description | 1 | General..... | 12 |
| Revision History | 2 | Applications Information | 14 |
| Specifications..... | 3 | Basic Connections..... | 14 |
| Typical Scattering Parameters (S-Parameters) | 5 | Soldering Information and Recommended | |
| Absolute Maximum Ratings..... | 7 | PCB Land Pattern..... | 15 |
| Thermal Resistance | 7 | Operation Down to 30 MHz..... | 16 |
| ESD Caution..... | 7 | W-CDMA ACPR Performance | 16 |
| Pin Configuration and Function Descriptions..... | 8 | Evaluation Board | 17 |
| Typical Performance Characteristics | 9 | Outline Dimensions | 18 |
| 500 MHz to 4 GHz Frequency Band..... | 9 | Ordering Guide | 18 |

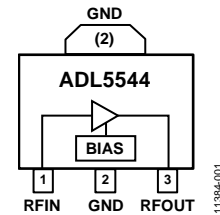
REVISION HISTORY

11/13—Rev. 0 to Rev. A

| | |
|--|----|
| Added Figure 25, Renumbered Sequentially | 12 |
| Changes to Figure 34..... | 15 |
| Updated Outline Dimensions | 18 |

4/13—Revision 0: Initial Version

SPECIFICATIONS

$V_{POS} = 5\text{ V}$ and $T_A = 25^\circ\text{C}$, unless otherwise noted.

Table 1.

| Parameter | Test Conditions/Comments | Min | Typ | Max | Unit |
|-------------------------------|---|------|------------|------|------|
| OVERALL FUNCTION | | | | | |
| Frequency Range | | 30 | | 6000 | MHz |
| FREQUENCY = 30 MHz | | | | | |
| Gain | | | 18.5 | | dB |
| Output 1 dB Compression Point | | | 13.0 | | dBm |
| Output Third-Order Intercept | $\Delta f = 1\text{ MHz}$, output power (P_{OUT}) = -7 dBm per tone | | 31.2 | | dBm |
| Noise Figure | | | 3.9 | | dB |
| FREQUENCY = 140 MHz | | | | | |
| Gain | | | 18.04 | | dB |
| vs. Frequency | $\pm 10\text{ MHz}$ | | ± 0.04 | | dB |
| vs. Temperature | $-40^\circ\text{C} \leq T_A \leq +85^\circ\text{C}$ | | ± 0.3 | | dB |
| vs. Supply | 4.75 V to 5.25 V | | ± 0.05 | | dB |
| Output 1 dB Compression Point | | | 16.9 | | dBm |
| Output Third-Order Intercept | $\Delta f = 1\text{ MHz}$, output power (P_{OUT}) = -7 dBm per tone | | 32.0 | | dBm |
| Noise Figure | | | 3.1 | | dB |
| FREQUENCY = 350 MHz | | | | | |
| Gain | | | 17.8 | | dB |
| vs. Frequency | $\pm 10\text{ MHz}$ | | ± 0.01 | | dB |
| vs. Temperature | $-40^\circ\text{C} \leq T_A \leq +85^\circ\text{C}$ | | ± 0.3 | | dB |
| vs. Supply | 4.75 V to 5.25 V | | ± 0.06 | | dB |
| Output 1 dB Compression Point | | | 17.4 | | dBm |
| Output Third-Order Intercept | $\Delta f = 1\text{ MHz}$, output power (P_{OUT}) = -7 dBm per tone | | 31.2 | | dBm |
| Noise Figure | | | 3.1 | | dB |
| FREQUENCY = 700 MHz | | | | | |
| Gain | | 17.1 | 17.6 | 18.0 | dB |
| vs. Frequency | $\pm 50\text{ MHz}$ | | ± 0.03 | | dB |
| vs. Temperature | $-40^\circ\text{C} \leq T_A \leq +85^\circ\text{C}$ | | ± 0.3 | | dB |
| vs. Supply | 4.75 V to 5.25 V | | ± 0.02 | | dB |
| Output 1 dB Compression Point | | | 17.4 | | dBm |
| Output Third-Order Intercept | $\Delta f = 1\text{ MHz}$, output power (P_{OUT}) = -7 dBm per tone | | 33.4 | | dBm |
| Noise Figure | | | 2.9 | | dB |
| FREQUENCY = 900 MHz | | | | | |
| Gain | | 17.0 | 17.4 | 17.8 | dB |
| vs. Frequency | $\pm 50\text{ MHz}$ | | ± 0.03 | | dB |
| vs. Temperature | $-40^\circ\text{C} \leq T_A \leq +85^\circ\text{C}$ | | ± 0.3 | | dB |
| vs. Supply | 4.75 V to 5.25 V | | ± 0.02 | | dB |
| Output 1 dB Compression Point | | | 17.6 | | dBm |
| Output Third-Order Intercept | $\Delta f = 1\text{ MHz}$, output power (P_{OUT}) = -7 dBm per tone | | 34.9 | | dBm |
| Noise Figure | | | 2.9 | | dB |
| FREQUENCY = 1900 MHz | | | | | |
| Gain | | 16.2 | 16.6 | 17.0 | dB |
| vs. Frequency | $\pm 50\text{ MHz}$ | | ± 0.05 | | dB |
| vs. Temperature | $-40^\circ\text{C} \leq T_A \leq +85^\circ\text{C}$ | | ± 0.3 | | dB |
| vs. Supply | 4.75 V to 5.25 V | | ± 0.04 | | dB |
| Output 1 dB Compression Point | | | 15.4 | | dBm |
| Output Third-Order Intercept | $\Delta f = 1\text{ MHz}$, output power (P_{OUT}) = -7 dBm per tone | | 32.4 | | dBm |
| Noise Figure | | | 3.4 | | dB |

| Parameter | Test Conditions/Comments | Min | Typ | Max | Unit |
|-------------------------------|--|------|-------|------|------|
| FREQUENCY = 2140 MHz | | | | | |
| Gain | | 15.9 | 16.4 | 16.7 | dB |
| vs. Frequency | ±50 MHz | | ±0.04 | | dB |
| vs. Temperature | −40°C ≤ T _A ≤ +85°C | | ±0.4 | | dB |
| vs. Supply | 4.75 V to 5.25 V | | ±0.05 | | dB |
| Output 1 dB Compression Point | | | 14.8 | | dBm |
| Output Third-Order Intercept | Δf = 1 MHz, output power (P _{OUT}) = −7 dBm per tone | | 31.3 | | dBm |
| Noise Figure | | | 3.5 | | dB |
| FREQUENCY = 2600 MHz | | | | | |
| Gain | | 15.6 | 16.0 | 16.4 | dB |
| vs. Frequency | ±50 MHz | | ±0.03 | | dB |
| vs. Temperature | −40°C ≤ T _A ≤ +85°C | | ±0.3 | | dB |
| vs. Supply | 4.75 V to 5.25 V | | ±0.05 | | dB |
| Output 1 dB Compression Point | | | 14.1 | | dBm |
| Output Third-Order Intercept | Δf = 1 MHz, output power (P _{OUT}) = −7 dBm per tone | | 30.0 | | dBm |
| Noise Figure | | | 3.7 | | dB |
| FREQUENCY = 3500 MHz | | | | | |
| Gain | | 15.2 | 15.6 | 16.1 | dB |
| vs. Frequency | ±50 MHz | | ±0.05 | | dB |
| vs. Temperature | −40°C ≤ T _A ≤ +85°C | | ±0.4 | | dB |
| vs. Supply | 4.75 V to 5.25 V | | ±0.03 | | dB |
| Output 1 dB Compression Point | | | 12.2 | | dBm |
| Output Third-Order Intercept | Δf = 1 MHz, output power (P _{OUT}) = −7 dBm per tone | | 26.0 | | dBm |
| Noise Figure | | | 4.1 | | dB |
| FREQUENCY = 4000 MHz | | | | | |
| Gain | | 14.4 | 15.0 | 15.5 | dB |
| vs. Frequency | ±50 MHz | | ±0.10 | | dB |
| vs. Temperature | −40°C ≤ T _A ≤ +85°C | | ±0.6 | | dB |
| vs. Supply | 4.75 V to 5.25 V | | ±0.08 | | dB |
| Output 1 dB Compression Point | | | 10.8 | | dBm |
| Output Third-Order Intercept | Δf = 1 MHz, output power (P _{OUT}) = −7 dBm per tone | | 23.8 | | dBm |
| Noise Figure | | | 4.6 | | dB |
| FREQUENCY = 5000 MHz | | | | | |
| Gain | | | 14.0 | | dB |
| vs. Frequency | ±50 MHz | | ±0.04 | | dB |
| vs. Temperature | −40°C ≤ T _A ≤ +85°C | | ±0.6 | | dB |
| vs. Supply | 4.75 V to 5.25 V | | ±0.10 | | dB |
| Output 1 dB Compression Point | | | 8.7 | | dBm |
| Output Third-Order Intercept | Δf = 1 MHz, output power (P _{OUT}) = −7 dBm per tone | | 21.3 | | dBm |
| Noise Figure | | | 4.8 | | dB |
| FREQUENCY = 5800 MHz | | | | | |
| Gain | | | 14.5 | | dB |
| vs. Frequency | ±50 MHz | | ±0.15 | | dB |
| vs. Temperature | −40°C ≤ T _A ≤ +85°C | | ±1.0 | | dB |
| vs. Supply | 4.75 V to 5.25 V | | ±0.10 | | dB |
| Output 1 dB Compression Point | | | 7.0 | | dBm |
| Output Third-Order Intercept | Δf = 1 MHz, output power (P _{OUT}) = −7 dBm per tone | | 18.7 | | dBm |
| Noise Figure | | | 5.4 | | dB |
| POWER INTERFACE | | | | | |
| Supply Voltage | V _{POS} | 4.75 | 5 | 5.25 | V |
| Supply Current | | | 55 | 69 | mA |
| vs. Temperature | −40°C ≤ T _A ≤ +85°C | | −5 | | mA |
| Power Dissipation | V _{POS} = 5 V | | 275 | | mW |

TYPICAL SCATTERING PARAMETERS (S-PARAMETERS)

$V_{POS} = 5\text{ V}$ and $T_A = 25^\circ\text{C}$. The effects of the test fixture have been deembedded up to the pins of the device.

Table 2.

| Frequency (MHz) | S11 | | S21 | | S12 | | S22 | |
|-----------------|----------------|-----------|----------------|-----------|----------------|-----------|----------------|-----------|
| | Magnitude (dB) | Angle (°) | Magnitude (dB) | Angle (°) | Magnitude (dB) | Angle (°) | Magnitude (dB) | Angle (°) |
| 30 | -9.75838 | -92.0495 | 19.91469 | 160.691 | -21.4134 | 19.08688 | -10.175 | -100.818 |
| 50 | -13.0161 | -114.478 | 18.9406 | 163.9441 | -21.1763 | 10.75632 | -12.7436 | -124.228 |
| 100 | -15.8296 | -142.951 | 18.34431 | 167.4073 | -21.0719 | 3.454046 | -14.8272 | -150.688 |
| 200 | -16.7468 | -164.185 | 18.13374 | 166.5362 | -21.059 | -2.10036 | -15.7366 | -169.056 |
| 300 | -16.7917 | -173.294 | 18.0488 | 163.4408 | -21.0741 | -5.56114 | -15.9476 | -177.5 |
| 400 | -16.7639 | -178.57 | 17.97824 | 159.7115 | -21.0901 | -8.54887 | -15.9985 | 177.0591 |
| 500 | -16.6368 | 176.8142 | 17.91669 | 155.6494 | -21.1284 | -11.3218 | -15.9997 | 172.8508 |
| 600 | -16.5495 | 172.727 | 17.85356 | 151.5874 | -21.1641 | -13.9309 | -15.9194 | 169.301 |
| 700 | -16.4931 | 169.7664 | 17.77106 | 147.4093 | -21.2044 | -16.5131 | -15.8227 | 166.4768 |
| 800 | -16.4227 | 166.4253 | 17.71131 | 143.3218 | -21.2438 | -19.0298 | -15.7257 | 163.7476 |
| 900 | -16.3553 | 163.4457 | 17.66826 | 139.1424 | -21.2871 | -21.5022 | -15.5947 | 162.0291 |
| 1000 | -16.4799 | 160.784 | 17.58888 | 134.9062 | -21.3302 | -23.9656 | -15.6619 | 160.4644 |
| 1100 | -16.4953 | 158.6829 | 17.53756 | 130.7521 | -21.3803 | -26.4082 | -15.644 | 159.4497 |
| 1200 | -16.7606 | 157.8074 | 17.47488 | 126.5829 | -21.4161 | -28.8192 | -15.8311 | 159.6244 |
| 1300 | -16.9103 | 157.3382 | 17.44318 | 122.3575 | -21.4674 | -31.2788 | -15.9907 | 159.7403 |
| 1400 | -17.2225 | 158.2929 | 17.38821 | 118.1946 | -21.5203 | -33.7399 | -16.21 | 160.9107 |
| 1500 | -17.6402 | 160.1629 | 17.33858 | 114.0765 | -21.5672 | -36.1081 | -16.539 | 162.8989 |
| 1600 | -18.0653 | 164.333 | 17.32871 | 109.7247 | -21.6024 | -38.6986 | -16.7579 | 165.3782 |
| 1700 | -18.5601 | 169.5526 | 17.27848 | 105.5495 | -21.6825 | -41.0309 | -17.0431 | 169.2425 |
| 1800 | -19.01 | 177.6071 | 17.22524 | 101.4425 | -21.7323 | -43.4108 | -17.1957 | 174.945 |
| 1900 | -19.1982 | -173.627 | 17.19407 | 97.28532 | -21.7873 | -45.7867 | -17.2297 | -179.104 |
| 2000 | -19.156 | -163.672 | 17.14779 | 93.09047 | -21.8417 | -48.1855 | -17.0968 | -171.974 |
| 2100 | -18.7447 | -154.484 | 17.1201 | 88.86399 | -21.8994 | -50.5584 | -16.8241 | -164.872 |
| 2200 | -18.2725 | -146.868 | 17.06239 | 84.78041 | -21.9604 | -52.8879 | -16.481 | -158.228 |
| 2300 | -17.5769 | -140.357 | 17.00071 | 80.71247 | -22.0229 | -55.1919 | -16.0694 | -152.253 |
| 2400 | -16.9363 | -136.067 | 16.97464 | 76.65373 | -22.0831 | -57.4478 | -15.6966 | -147.411 |
| 2500 | -16.3707 | -133.128 | 16.91632 | 72.6253 | -22.1477 | -59.6933 | -15.4361 | -143.919 |
| 2600 | -15.8425 | -131.025 | 16.84092 | 68.6308 | -22.2125 | -61.938 | -15.2228 | -141.803 |
| 2700 | -15.4474 | -130.097 | 16.80102 | 64.69363 | -22.2782 | -64.111 | -15.209 | -141.248 |
| 2800 | -15.1642 | -129.731 | 16.74106 | 60.74876 | -22.3485 | -66.3047 | -15.2585 | -142.511 |
| 2900 | -14.9231 | -130.057 | 16.68572 | 56.76032 | -22.4164 | -68.5093 | -15.3514 | -145.642 |
| 3000 | -14.8791 | -130.912 | 16.64527 | 52.71256 | -22.4858 | -70.6726 | -15.4628 | -150.396 |
| 3100 | -14.8847 | -132.738 | 16.56622 | 48.69909 | -22.5616 | -72.9343 | -15.4514 | -156.986 |
| 3200 | -14.9364 | -134.966 | 16.51404 | 44.62054 | -22.636 | -75.1868 | -15.2627 | -164.185 |
| 3300 | -15.1065 | -138.423 | 16.45702 | 40.56141 | -22.7184 | -77.4701 | -14.9704 | -171.492 |
| 3400 | -15.2148 | -142.265 | 16.38871 | 36.48298 | -22.8123 | -79.8304 | -14.4379 | -178.173 |
| 3500 | -15.2414 | -147.094 | 16.3331 | 32.32549 | -22.9021 | -82.0942 | -13.8431 | 175.3551 |
| 3600 | -15.0937 | -152.434 | 16.26873 | 28.0511 | -23.0024 | -84.4293 | -13.2863 | 169.8835 |
| 3700 | -14.8339 | -157.56 | 16.2039 | 23.84273 | -23.1015 | -86.7756 | -12.7034 | 164.8455 |
| 3800 | -14.3558 | -162.074 | 16.11548 | 19.63339 | -23.2085 | -89.1254 | -12.1263 | 160.5459 |
| 3900 | -13.7757 | -166.117 | 16.03442 | 15.32869 | -23.3318 | -91.426 | -11.5679 | 156.6935 |
| 4000 | -13.0504 | -169.18 | 15.92646 | 11.18556 | -23.4494 | -93.8454 | -10.9616 | 153.5414 |
| 4100 | -12.3247 | -171.219 | 15.82941 | 6.975896 | -23.577 | -96.1196 | -10.3638 | 151.0243 |
| 4200 | -11.6347 | -173.249 | 15.72571 | 2.726895 | -23.7138 | -98.3778 | -9.78722 | 149.3781 |
| 4300 | -10.9654 | -174.775 | 15.58441 | -1.36477 | -23.8541 | -100.612 | -9.23037 | 148.452 |
| 4440 | -10.2422 | -176.69 | 15.44684 | -7.08335 | -24.0446 | -103.673 | -8.61459 | 148.1682 |
| 4500 | -9.95152 | -177.613 | 15.38641 | -9.50947 | -24.1234 | -104.95 | -8.40319 | 148.3894 |
| 4600 | -9.51739 | -178.831 | 15.2557 | -13.503 | -24.2418 | -107.053 | -8.1407 | 148.9119 |

| Frequency (MHz) | S11 | | S21 | | S12 | | S22 | |
|-----------------|----------------|-----------|----------------|-----------|----------------|-----------|----------------|-----------|
| | Magnitude (dB) | Angle (°) | Magnitude (dB) | Angle (°) | Magnitude (dB) | Angle (°) | Magnitude (dB) | Angle (°) |
| 4700 | -9.15961 | 179.4184 | 15.18857 | -17.5037 | -24.3599 | -109.077 | -8.00124 | 149.4702 |
| 4800 | -8.81402 | 177.4327 | 15.08704 | -21.4903 | -24.4618 | -111.079 | -7.96813 | 149.7089 |
| 4900 | -8.53104 | 175.2276 | 14.98061 | -25.462 | -24.5534 | -113.068 | -8.06461 | 149.4032 |
| 5000 | -8.30896 | 172.6355 | 14.92996 | -29.3613 | -24.6449 | -114.946 | -8.27561 | 148.5568 |
| 5100 | -8.09121 | 170.0194 | 14.84603 | -33.2282 | -24.7131 | -116.819 | -8.51734 | 146.6025 |
| 5200 | -7.92674 | 167.1306 | 14.7721 | -37.1236 | -24.7652 | -118.67 | -8.77718 | 143.5944 |
| 5300 | -7.79364 | 163.9153 | 14.72301 | -41.0236 | -24.8151 | -120.546 | -8.99346 | 139.518 |
| 5400 | -7.6793 | 160.6589 | 14.64549 | -45.0881 | -24.8399 | -122.534 | -9.12197 | 134.7305 |
| 5500 | -7.61523 | 156.9392 | 14.59131 | -49.1815 | -24.8628 | -124.569 | -9.17338 | 129.7103 |
| 5600 | -7.60815 | 152.7976 | 14.53579 | -53.2876 | -24.8758 | -126.604 | -9.15423 | 124.593 |
| 5700 | -7.54914 | 148.5617 | 14.47484 | -57.5187 | -24.8597 | -128.793 | -9.05211 | 119.5068 |
| 5800 | -7.51209 | 143.7768 | 14.45495 | -61.7253 | -24.8296 | -131.021 | -9.00726 | 114.4158 |
| 5900 | -7.46152 | 138.6641 | 14.42222 | -66.0417 | -24.7902 | -133.375 | -9.00598 | 109.1347 |
| 6000 | -7.35914 | 133.6743 | 14.38015 | -70.439 | -24.7398 | -135.849 | -9.00546 | 103.4141 |

ABSOLUTE MAXIMUM RATINGS

Table 3.

| Parameter | Rating |
|--|-----------------|
| Supply Voltage, V_{POS} | 6.5 V |
| Input Power (50 Ω Impedance) | 18 dBm |
| Internal Power Dissipation (Pad Soldered to Ground) | 400 mW |
| Maximum Junction Temperature | 150°C |
| Operating Temperature Range | –40°C to +105°C |
| Storage Temperature Range | –65°C to +150°C |

Stresses above those listed under Absolute Maximum Ratings may cause permanent damage to the device. This is a stress rating only; functional operation of the device at these or any other conditions above those indicated in the operational section of this specification is not implied. Exposure to absolute maximum rating conditions for extended periods may affect device reliability.

THERMAL RESISTANCE

Table 4 lists the junction-to-air thermal resistance (θ_{JA}) and the junction-to-case thermal resistance (θ_{JC}) for the ADL5544.

Table 4. Thermal Resistance

| Package Type | θ_{JA} ¹ | θ_{JC} ² | Unit |
|----------------------|----------------------------|----------------------------|------|
| 3-Lead SOT-89 (RK-3) | 53 | 15 | °C/W |

¹ Measured on the ADL5544 evaluation board. For more information about board layout, see the Soldering Information and Recommended PCB Land Pattern section.

² Based on simulation with a standard JEDEC board per JESD51.

ESD CAUTION



ESD (electrostatic discharge) sensitive device. Charged devices and circuit boards can discharge without detection. Although this product features patented or proprietary protection circuitry, damage may occur on devices subjected to high energy ESD. Therefore, proper ESD precautions should be taken to avoid performance degradation or loss of functionality.

PIN CONFIGURATION AND FUNCTION DESCRIPTIONS

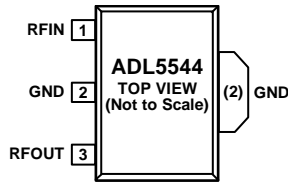

NOTES
 1. THE EXPOSED PAD ENCOMPASSES PIN 2 AND THE TAB AT THE TOP SIDE OF THE PACKAGE. SOLDER THE EXPOSED PAD TO A LOW IMPEDANCE GROUND PLANE FOR ELECTRICAL GROUNDING AND THERMAL TRANSFER.

11384-002

Figure 2. Pin Configuration

Table 5. Pin Function Descriptions

| Pin No. | Mnemonic | Description |
|---------|----------|--|
| 1 | RFIN | RF Input. This pin requires a dc blocking capacitor. |
| 2 | GND | Ground. Connect this pin to a low impedance ground plane. |
| 3 | RFOUT | RF Output and Supply Voltage. DC bias is provided to this pin through an inductor that is connected to the external power supply. The RF path requires a dc blocking capacitor. |
| | EPAD | Exposed Pad. The exposed pad encompasses Pin 2 and the tab at the top side of the package. Solder the exposed pad to a low impedance ground plane for electrical grounding and thermal transfer. |

TYPICAL PERFORMANCE CHARACTERISTICS

500 MHz TO 4 GHz FREQUENCY BAND

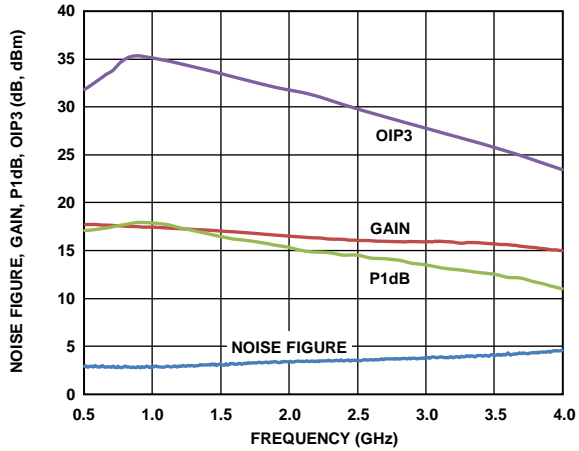

Figure 3. Noise Figure, Gain, P1dB, and OIP3 vs. Frequency

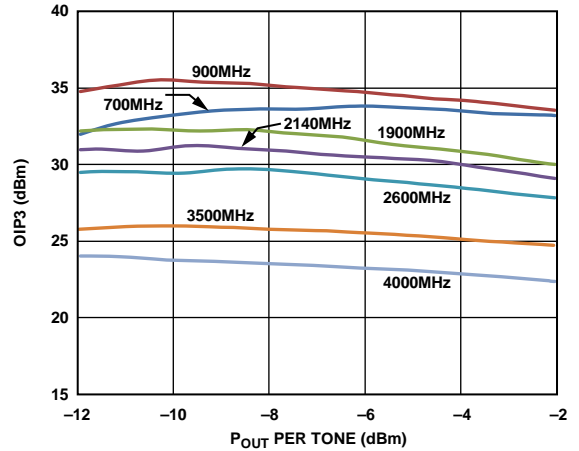

Figure 6. OIP3 vs. Output Power (P_{OUT}) and Frequency

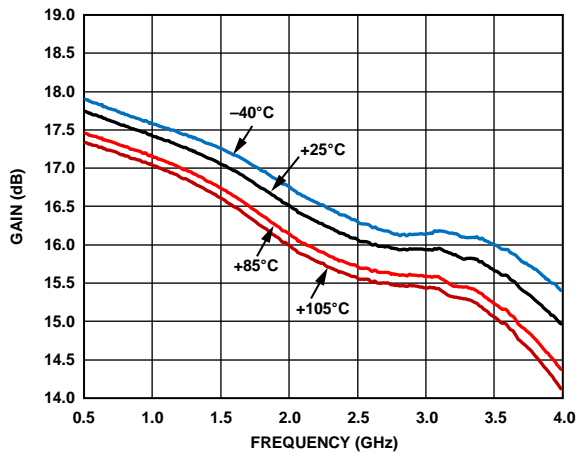

Figure 4. Gain vs. Frequency and Temperature

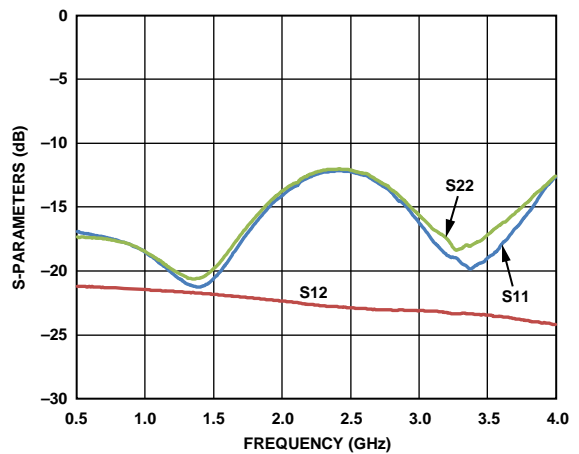

Figure 7. Input Return Loss (S_{11}), Output Return Loss (S_{22}), and Reverse Isolation (S_{12}) vs. Frequency

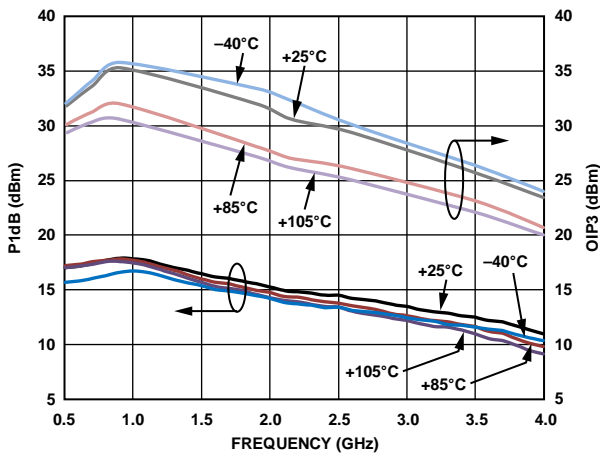

Figure 5. P1dB and OIP3 vs. Frequency and Temperature

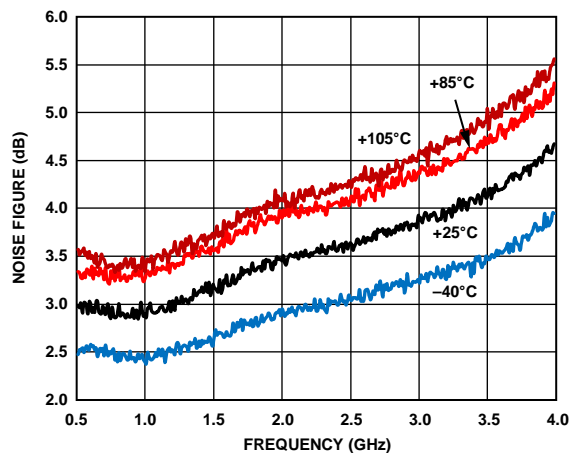

Figure 8. Noise Figure vs. Frequency and Temperature

11384-003

11384-006

11384-004

11384-007

11384-005

11384-008

100 MHz TO 500 MHz FREQUENCY BAND

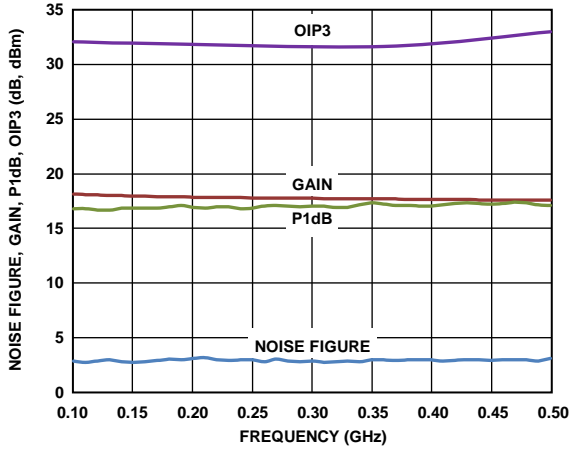

Figure 9. Noise Figure, Gain, P1dB, and OIP3 vs. Frequency, Low Frequency Configuration

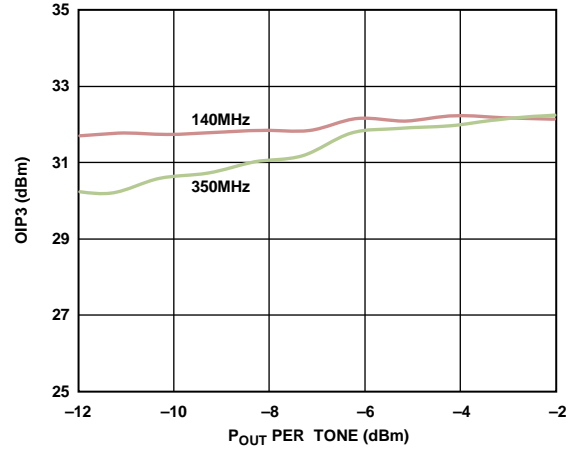

Figure 12. OIP3 vs. Output Power (P_{OUT}) and Frequency, Low Frequency Configuration

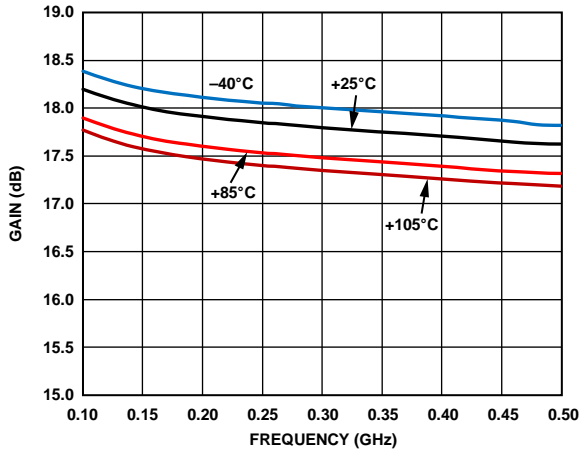

Figure 10. Gain vs. Frequency and Temperature, Low Frequency Configuration

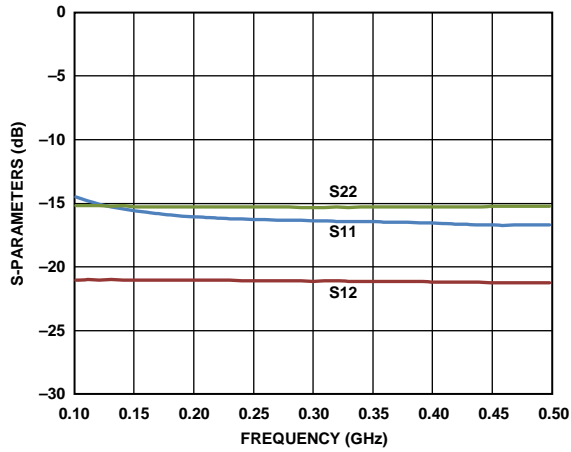

Figure 13. Input Return Loss (S11), Output Return Loss (S22), and Reverse Isolation (S12) vs. Frequency, Low Frequency Configuration

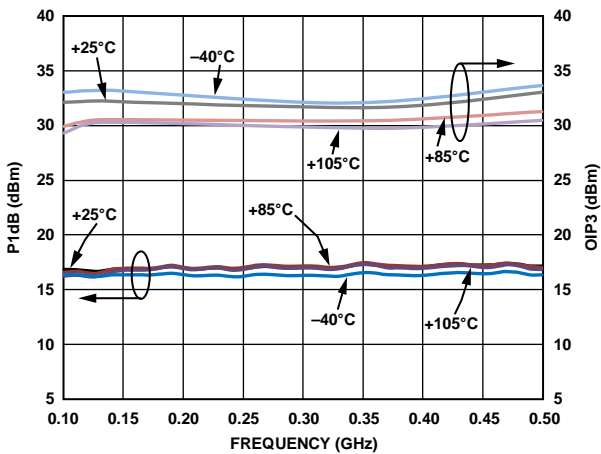

Figure 11. P1dB and OIP3 vs. Frequency and Temperature, Low Frequency Configuration

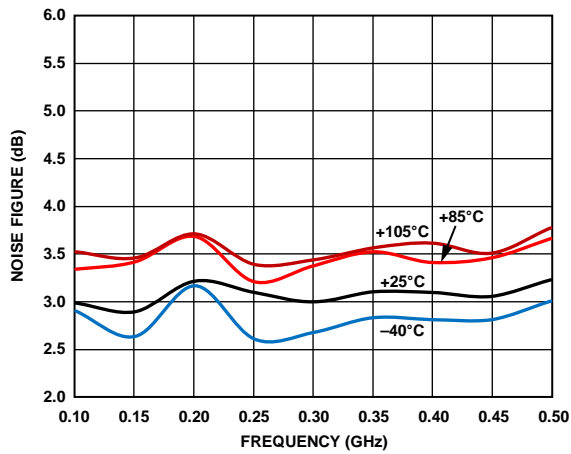

Figure 14. Noise Figure vs. Frequency and Temperature, Low Frequency Configuration

4 GHz TO 6 GHz FREQUENCY BAND

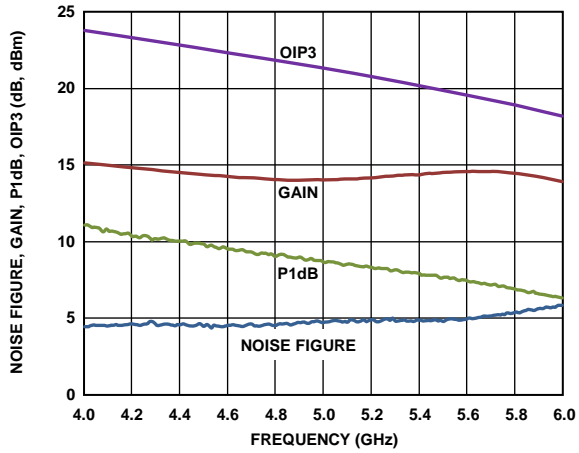

Figure 15. Noise Figure, Gain, P1dB, and OIP3 vs. Frequency, High Frequency Configuration

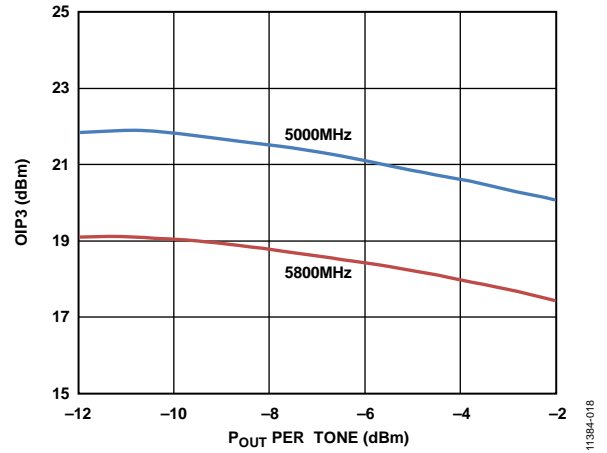

Figure 18. OIP3 vs. Output Power (P_{out}) and Frequency, High Frequency Configuration

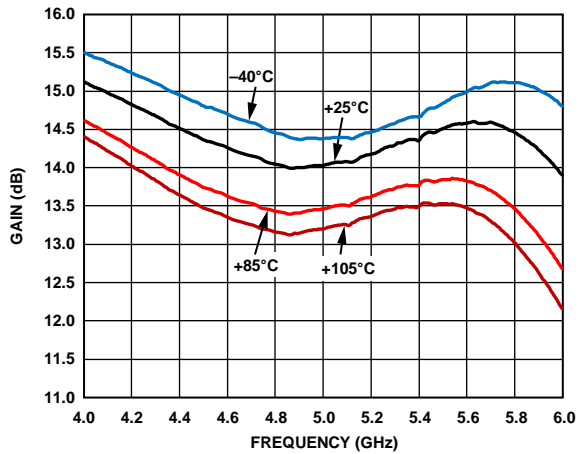

Figure 16. Gain vs. Frequency and Temperature, High Frequency Configuration

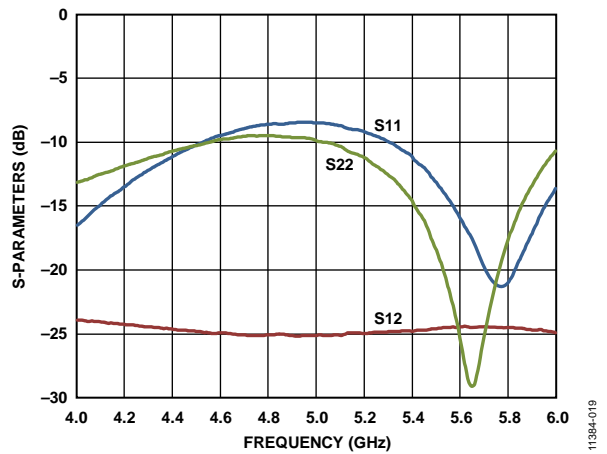

Figure 19. Input Return Loss (S11), Output Return Loss (S22), and Reverse Isolation (S12) vs. Frequency, High Frequency Configuration

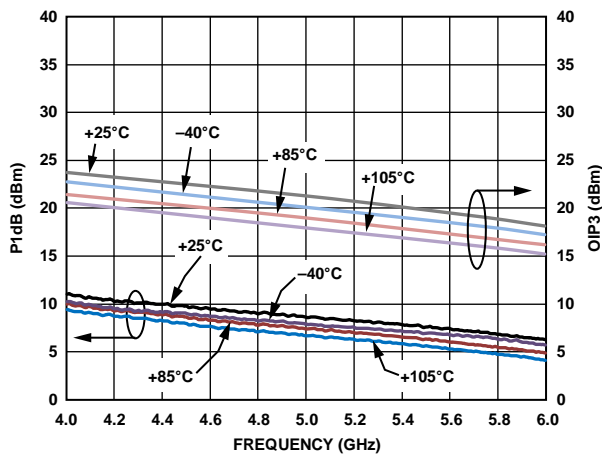

Figure 17. P1dB and OIP3 vs. Frequency and Temperature, High Frequency Configuration

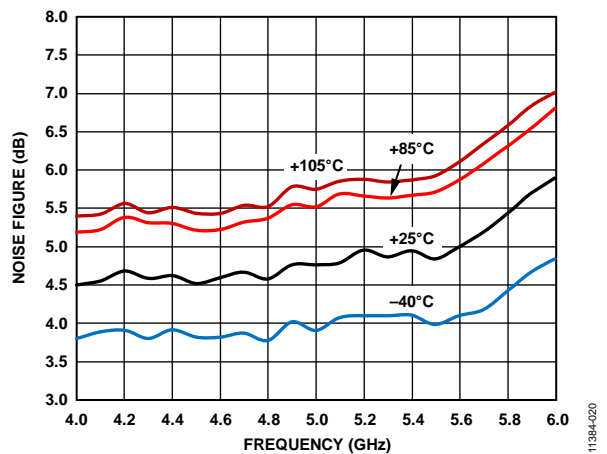

Figure 20. Noise Figure vs. Frequency and Temperature, High Frequency Configuration

GENERAL

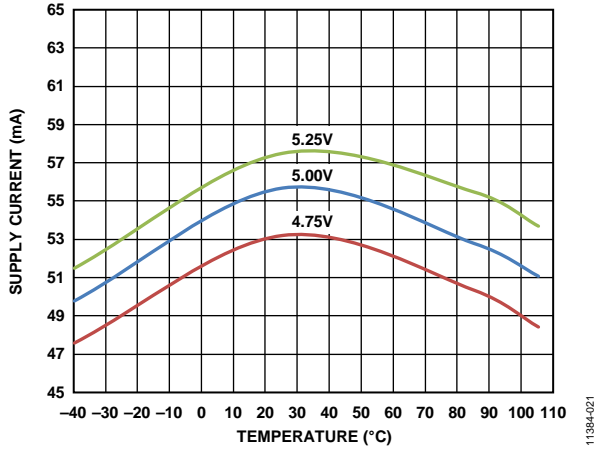

Figure 21. Supply Current vs. Temperature

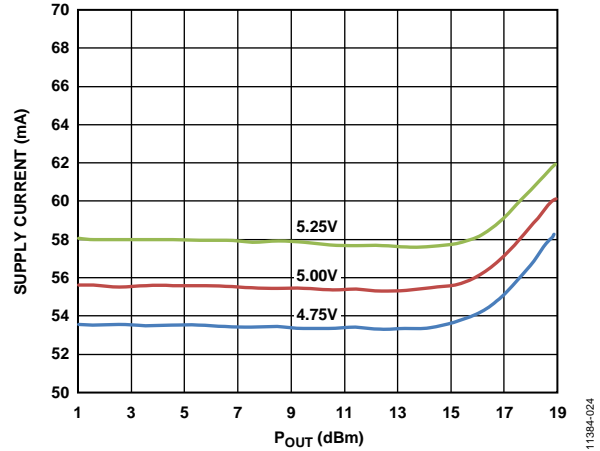

Figure 24. Supply Current vs. POUT at 900 MHz

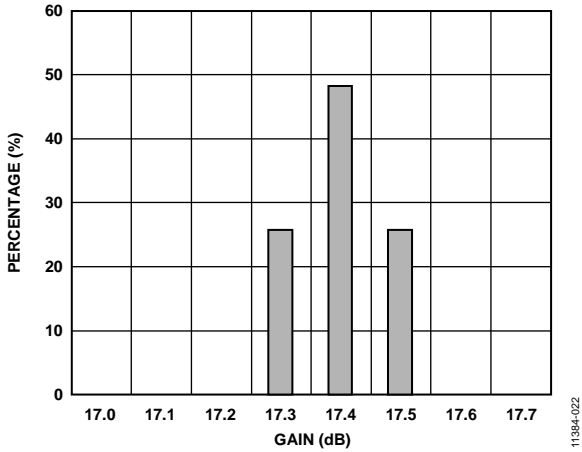

Figure 22. Gain Distribution at 900 MHz

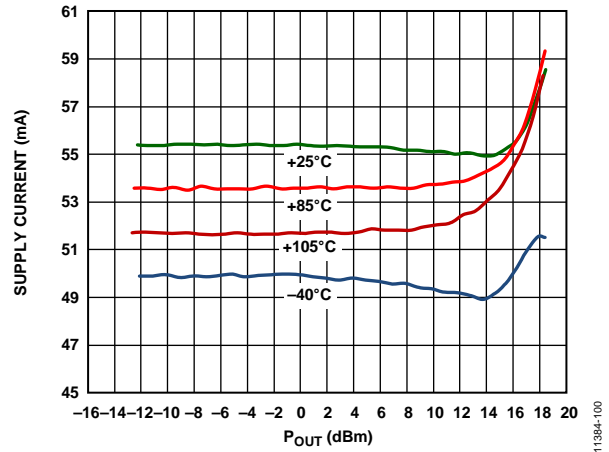

Figure 25. Supply Current vs. POUT and Temperature at 900 MHz

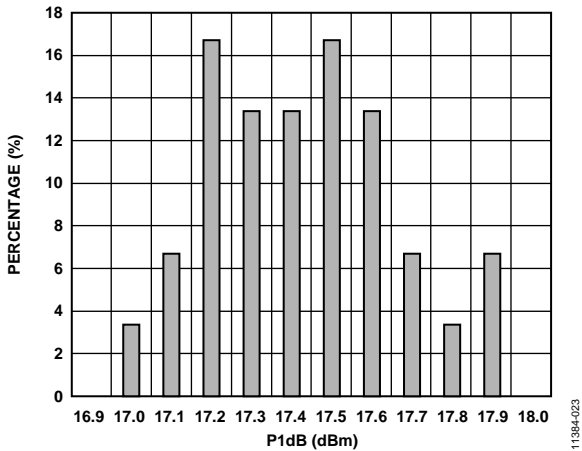

Figure 23. P1dB Distribution at 900 MHz

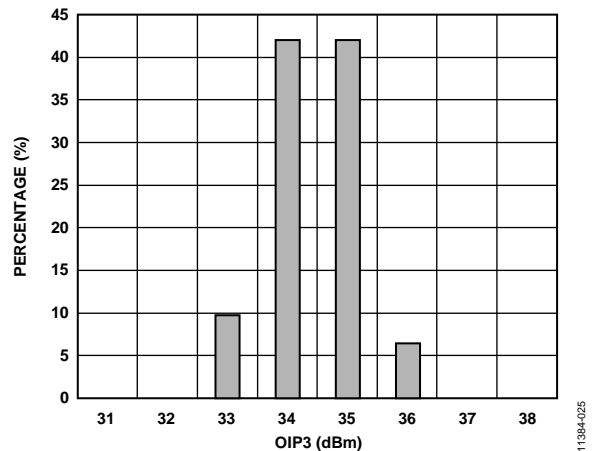

Figure 26. OIP3 Distribution at 900 MHz, POUT = -7 dBm per Tone

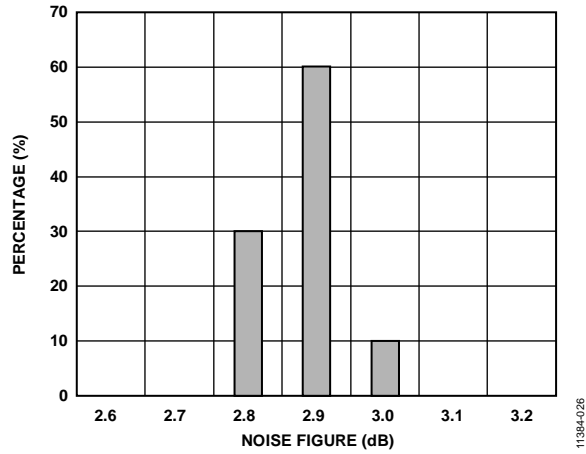

Figure 27. Noise Figure Distribution at 900 MHz

11384-026

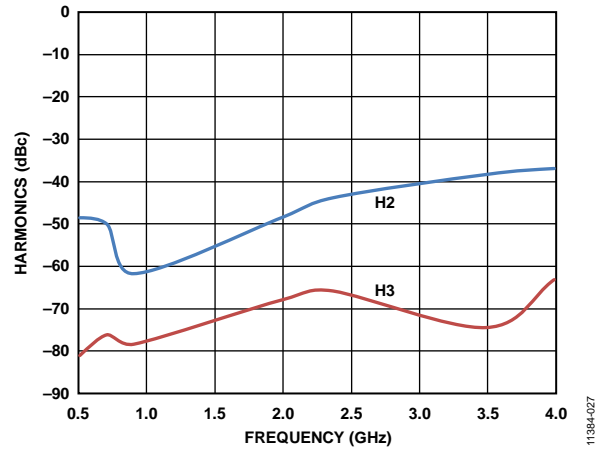

Figure 28. Single-Tone Harmonics vs. Frequency, $P_{OUT} = 0 \text{ dBm}$

11384-027

APPLICATIONS INFORMATION

BASIC CONNECTIONS

Figure 29 shows the basic connections for operating the ADL5544. The device supports operation from 30 MHz to 6 GHz. However, for optimal performance at lower and higher frequency bands, the board configuration must be adjusted. Table 6 lists the recommended board configuration to operate the device at various frequency bands.

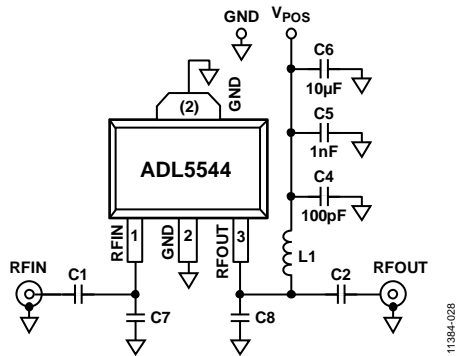

Figure 29. Basic Connections

A 5 V dc bias is supplied to the amplifier through the bias inductor connected to RFOUT (Pin 3). The bias voltage must be decoupled using 100 pF, 1 nF, and 10 μF power supply decoupling capacitors. The typical current consumption for the ADL5544 is 55 mA.

At low and high frequencies, the device exhibits improved performance with the suggested setup configuration listed in Table 6. Figure 30 to Figure 33 provide a comparison of the performance of the device at the 100 MHz to 500 MHz and 4 GHz to 6 GHz bands when driven with the optimal setup configuration and the default setup configuration.

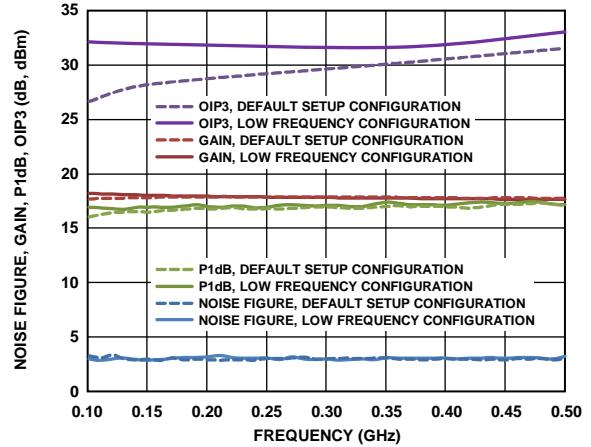

Figure 30. Noise Figure, Gain, P1dB, and OIP3 vs. Frequency, 100 MHz to 500 MHz, Comparison of Performance with the Optimized Settings and the Default Configuration

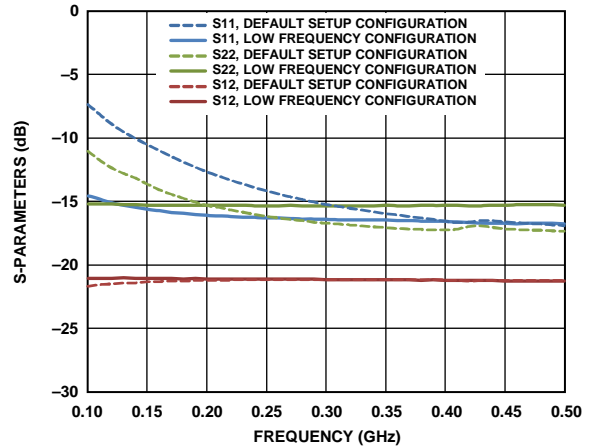

Figure 31. Return Loss and Reverse Isolation, 100 MHz to 500 MHz, Comparison of Performance with the Optimized Settings and the Default Configuration

Table 6. Recommended Components for Basic Connections

| Frequency Band | AC Coupling Capacitors (0402) | | DC Bias Inductor (0603HP) | High Frequency Matching Capacitors (0402) | |
|----------------------------|-------------------------------|--------|---------------------------|---|----------------|
| | C1 | C2 | L1 | C7 | C8 |
| 100 MHz to 500 MHz | 100 nF | 100 nF | 1000 nH | Do not install | Do not install |
| 500 MHz to 4 GHz (default) | 100 pF | 100 pF | 100 nH | Do not install | Do not install |
| 4 GHz to 6 GHz | 100 pF | 100 pF | 12 nH | 0.1 pF | 0.1 pF |

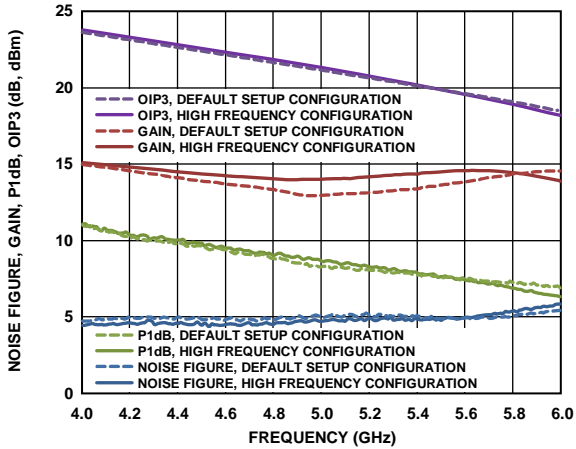

Figure 32. Noise Figure, Gain, P1dB, and OIP3 vs. Frequency, 4 GHz to 6 GHz, Comparison of Performance with the Optimized Settings and the Default Configuration

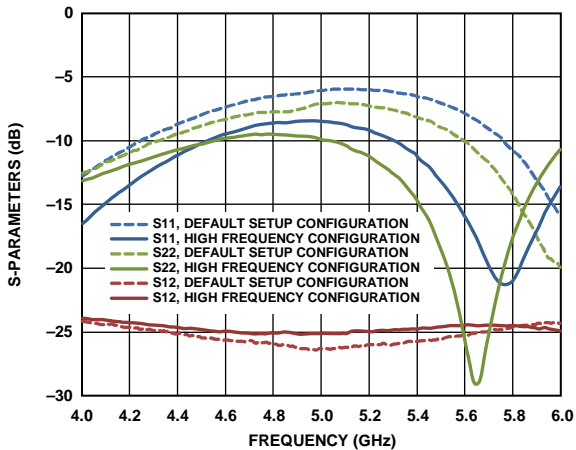

Figure 33. Return Loss and Reverse Isolation, 4 GHz to 6 GHz, Comparison of Performance with the Optimized Settings and the Default Configuration

SOLDERING INFORMATION AND RECOMMENDED PCB LAND PATTERN

Figure 34 shows the recommended land pattern for the ADL5544. To minimize thermal impedance, the exposed pad on the underside of the SOT-89 package is soldered to a ground plane, along with Pin 2. If multiple ground layers exist, stitch the layers together using vias.

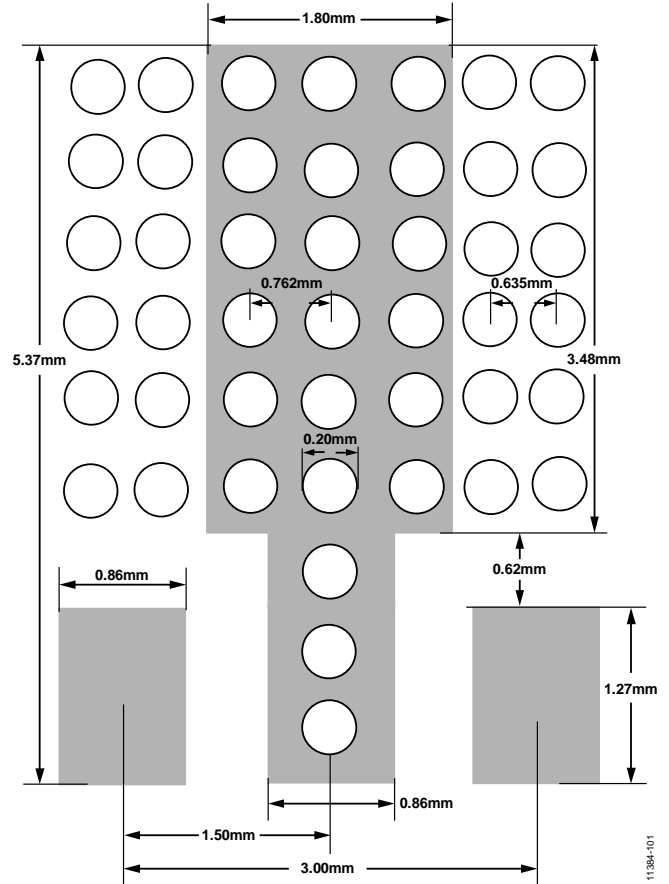

Figure 34. Recommended Land Pattern

The land pattern on the ADL5544 evaluation board provides a measured thermal resistance (θ_{JA}) of 53°C/W. To measure θ_{JA} , the temperature at the top of the SOT-89 package is found with an IR temperature gun. Thermal simulation suggests a junction temperature 10°C higher than the top-of-package temperature. With additional measurements of the ambient temperature and I/O power, θ_{JA} can be determined.

OPERATION DOWN TO 30 MHz

To operate the ADL5544 at frequencies below 100 MHz, a feedback network must be implemented between the input and output ports of the device to ensure stability. Figure 35 shows a sample configuration used to evaluate the device at frequencies below 100 MHz. Figure 36 to Figure 38 demonstrate the performance of the device in this configuration.

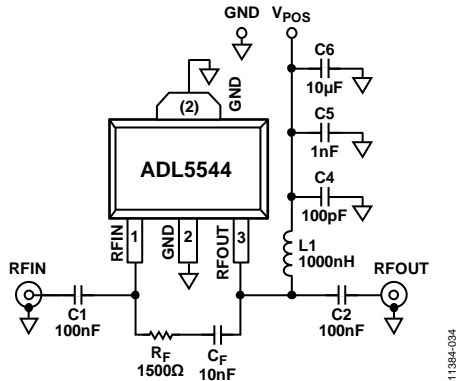

Figure 35. Setup for Low Frequency Operation Down to 30 MHz

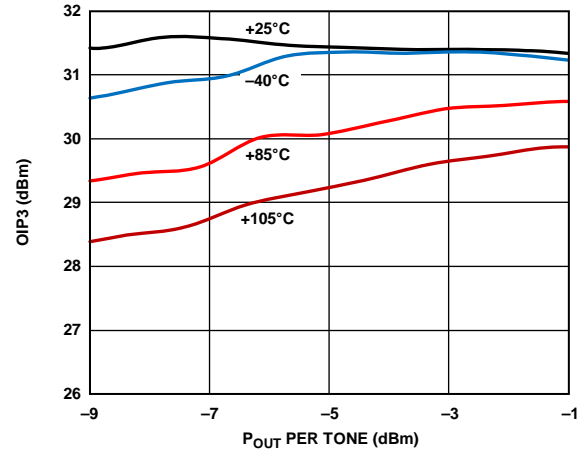

Figure 38. OIP3 vs. POUT at 30 MHz

W-CDMA ACPR PERFORMANCE

Figure 39 shows a plot of the adjacent channel power ratio (ACPR) vs. POUT for the ADL5544. The signal type used is a single wideband code division multiple access (W-CDMA) carrier (Test Model 1-64) at 2140 MHz. This signal is generated by a very low ACPR source. ACPR is measured at the output by a high dynamic range spectrum analyzer that incorporates an instrument noise-correction function.

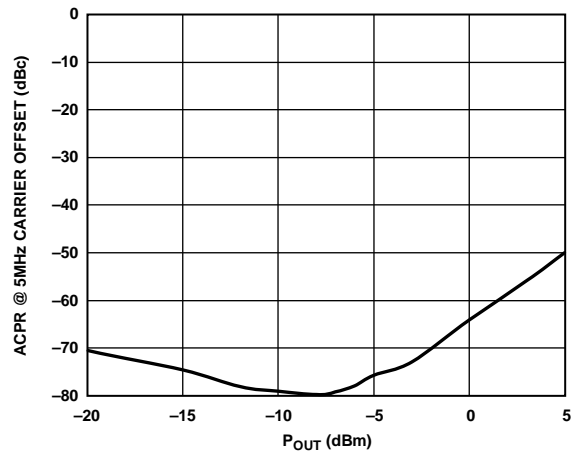

Figure 39. ACPR vs. POUT, Single W-CDMA Carrier (Test Model 1-64) at 2140 MHz

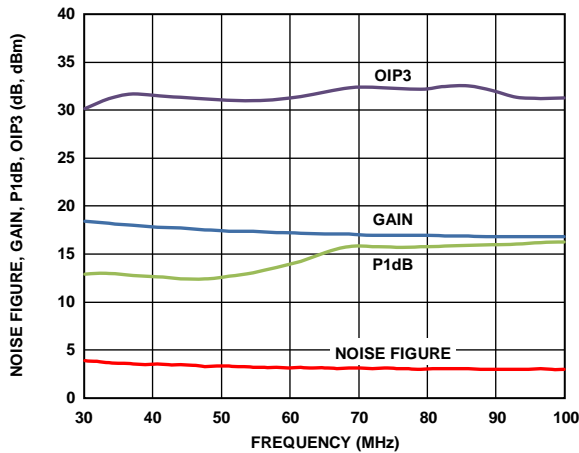

Figure 36. Noise Figure, Gain, P1dB, and OIP3 vs. Frequency, 30 MHz to 100 MHz

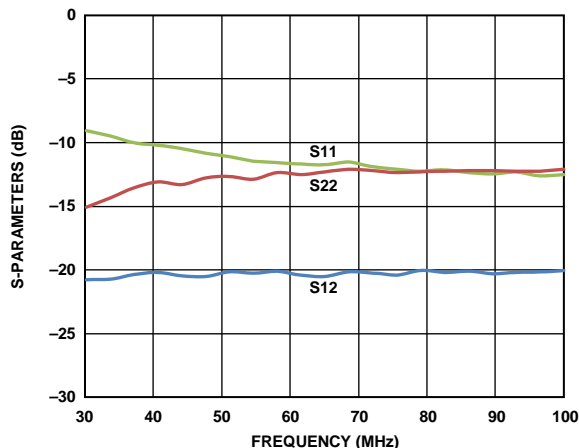

Figure 37. Return Loss and Reverse Isolation, 30 MHz to 100 MHz

EVALUATION BOARD

Figure 40 shows the ADL5544 evaluation board layout. Figure 41 shows the schematic for the evaluation board. The board is powered by a single 5 V supply. Table 7 lists the components used on the evaluation board. Power can be applied to the board through clip-on leads (V_{SUP} , GND).

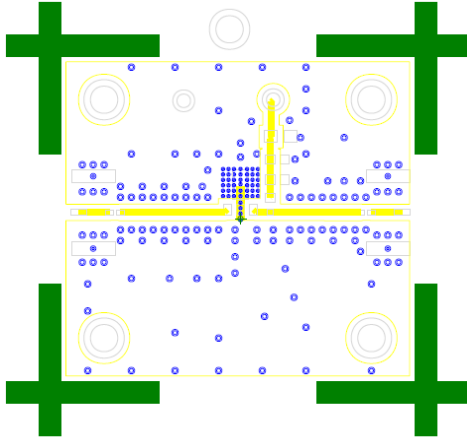

Figure 40. Evaluation Board Layout (Top)

11384-039

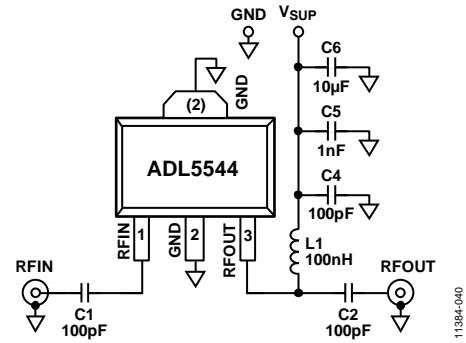

Figure 41. Evaluation Board Schematic

11384-040

Table 7. Evaluation Board Configuration Options

| Component | Function | Default Value |
|-------------------|------------------------------------|---|
| C1, C2 | AC coupling capacitors | 100 pF, 0402 |
| L1 | DC bias inductor | 100 nH, 0603 (Coilcraft 0603HP or equivalent) |
| V_{SUP} and GND | Clip-on terminals for power supply | |
| C4, C5, C6 | Power supply decoupling capacitors | C4: 100 pF, 0603 C5: 1 nF, 0603 C6: 10 µF, 1206 |

OUTLINE DIMENSIONS

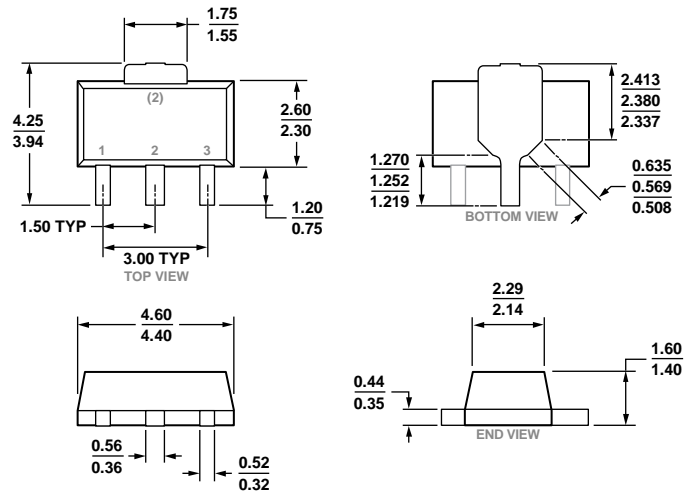

COMPLIANT TO JEDEC STANDARDS TO-243

Figure 42. 3-Lead Small Outline Transistor Package [SOT-89] (RK-3)

Dimensions shown in millimeters

ORDERING GUIDE

| Model ¹ | Temperature Range | Package Description | Package Option |
|--------------------|-------------------|---------------------------------|----------------|
| ADL5544ARKZ-R7 | -40°C to +105°C | 3-Lead SOT-89, 7" Tape and Reel | RK-3 |
| ADL5544-EVALZ | -40°C to +105°C | Evaluation Board | |

¹ Z = RoHS Compliant Part.

NOTES

NOTES