

REVISIONS					
REV	ECO	DESCRIPTION	DATE	BY	APPR
A1	-	RELEASE NEW DRAWING	11APR18	ROOKIE	TOMMY
A2	-	REVISED DESCRIPTION	12JUN19	JAH	DH
A3	-	UPDATE THE APPEARANCE	11NOV21	RONALD	TOMMY

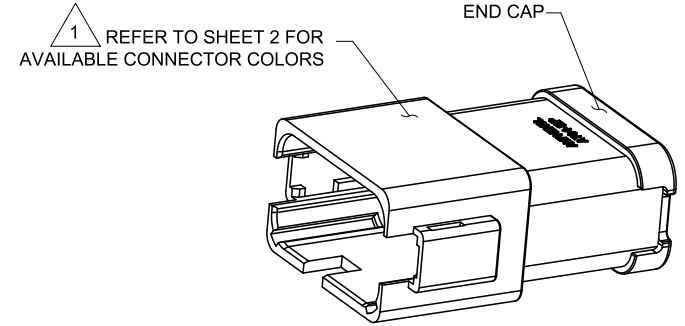
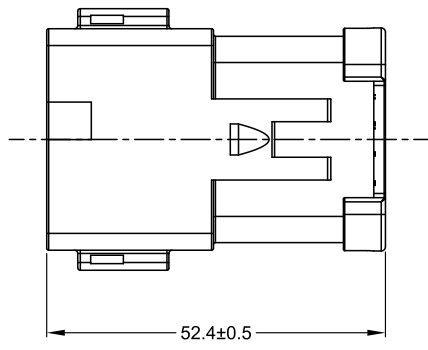
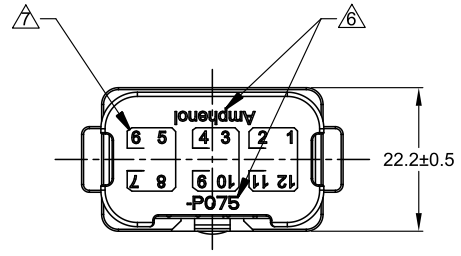
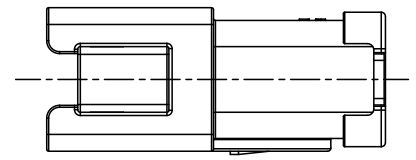
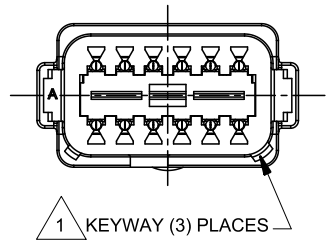
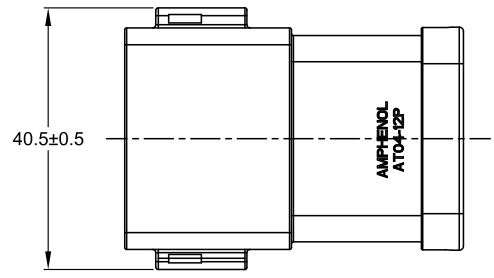

NOTES: UNLESS OTHERWISE SPECIFIED

△ SEE SHEET 2 FOR KEY ARRANGEMENTS AND COLORS.

2. MATERIAL:
HOUSING: THERMOPLASTIC
SEAL: SILICONE RUBBER
CONTACT: COPPER ALLOY
3. MODIFICATIONS: 3 PIECES OF 4 PIN BUSBAR WITH NICKEL PLATED
4. SPECIFICATIONS:
 - 4.1 CURRENT RATING: 26 AMPS MAXIMUM FOR THE 4 PIN BUSBAR
 - 4.2 OPERATING TEMPERATURE: -55°C TO +125°C.
 - 4.3 DIELECTRIC WITHSTANDING VOLTAGE: LESS THAN 2 MILLIAMPS CURRENT LEAKAGE @ 1500 VOLTS AC.
 - 4.4 INSULATION RESISTANCE: 1000 MEGOHM MIN @ 25°C.
 - 4.5 MOISTURE RESISTANCE: IP69K & IP68 (1M OF WATER FOR A PERIOD OF 24 HOURS, MATED CONDITION)
 - 4.6 MATING CYCLE DURABILITY: 100 CYCLES
 - 4.7 RoHS COMPLIANT

5. MATING PART: AT06-12SX* PLUG
(X=A,B,C,D KEYS * = AVAILABLE MODIFICATIONS)

△ ORIENTATION OF "Amphenol" AND "-P075" TO BE OPTIONAL

△ BORDERS SIGNIFY THAT EACH GROUP OF PINS (PINS 1,2,11,12 AND PINS 3,4,9,10 AND PINS 5,6,7,8) ARE BUSSED TOGETHER WITH A 4 PIN BUSBAR

8. ALL DIMENSIONS ARE FOR REFERENCE USE ONLY.

QUANTITY	SEE SHEET 2	REF: DT04-12PA-P075 & DT04-12PB-P075 & DT04-12PC-P075 & DT04-12PD-P075	ITEM
	PART NUMBER	DESCRIPTION	
MATERIALS LIST			
UNLESS OTHERWISE SPECIFIED 1) All dimensions are in metric(mm). 2) Tolerances are as follows: 1 PL DEC ±0.30 Fractions ±1/64 2 PL DEC ±0.15 Angles ±1° 3) Note reference = △		SIGNATURES DATE DRAWN: RONALD 11NOV21 CHECKED: ORION 12NOV21 ENGINEER: APPROVAL: TOMMY 15NOV21	
MATERIAL SPECIFICATIONS: WEIGHT: 27.6g		CUSTOMER: THIS DRAWING IS SUPPLIED FOR INFORMATION ONLY. DESIGN FEATURES, SPECIFICATIONS AND PERFORMANCE DATA SHOWN HEREON ARE THE PROPERTY OF THE AMPHENOL CORPORATION. NO RIGHTS OF REPRODUCTION ARE IMPLIED. ALL DIMENSIONS ARE SUBJECT TO NORMAL MANUFACTURING VARIATIONS.	
PROCESS SPECIFICATIONS:		SIZE TYPE DWG NO. REVISION B C- AT04-12PX-P075 A3	
NEXT ASSY:		SCALE: NONE SHEET 1 OF 2	

TITLE: HYPERBUSS AT 12WAY RECP (3)4 PIN BUSBAR NICKEL-PLATED
DWG NO: AT04-12PX-P075
REV: A3
SH: 1
OF: 2

REVISIONS					
REV	ECO	DESCRIPTION	DATE	BY	APPR
A1	-	RELEASE NEW DRAWING	11APR18	ROOKIE	TOMMY
A2	-	REVISED DESCRIPTION	12JUN19	JAH	DH
A3	-	UPDATE THE APPEARANCE	11NOV21	RONALD	TOMMY

P/N AT04-12PA-P075
KEY-A CONFIGURATION
STANDARD COLOR: GREY

P/N AT04-12PB-P075
KEY-B CONFIGURATION
STANDARD COLOR: BLACK

P/N AT04-12PC-P075
KEY-C CONFIGURATION
STANDARD COLOR: GREEN

P/N AT04-12PD-P075
KEY-D CONFIGURATION
STANDARD COLOR: BROWN

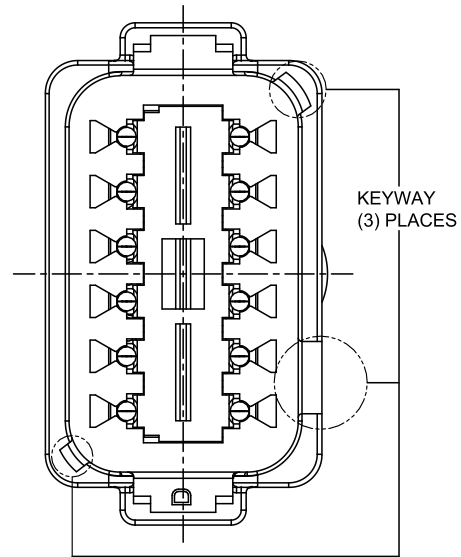
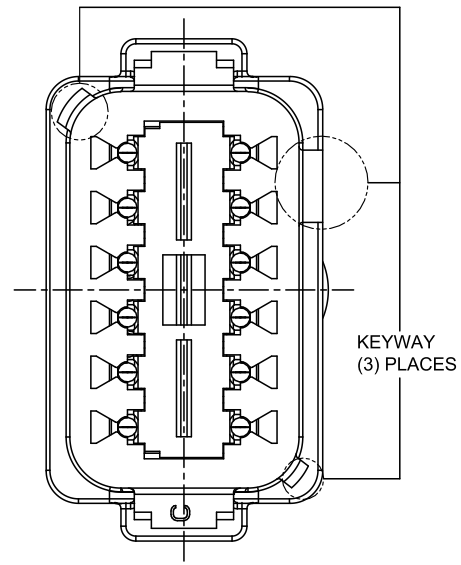
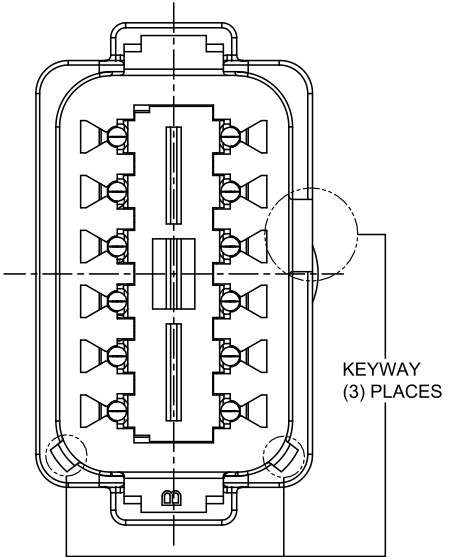
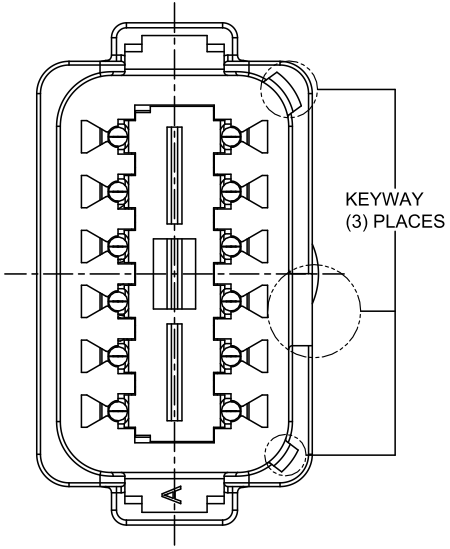

TITLE: HYPERBUSS AT 12WAY RECP (3)4 PIN BUSBAR NICKEL-PLATED
DWG NO: AT04-12PX-P075
REV: A3
SH: 2
OF: 2

QUANTITY	PART NUMBER	DESCRIPTION	ITEM										
MATERIALS LIST													
<small>UNLESS OTHERWISE SPECIFIED</small> 1) All dimensions are in metric (mm). 2) Tolerances are as follows: 1 PL DEC ±0.30 Fractions ±1/64 2 PL DEC ±0.15 Angles ±1° 3 PL DEC ±0.08 3) Note reference =		<table border="1"> <thead> <tr> <th>SIGNATURES</th> <th>DATE</th> </tr> </thead> <tbody> <tr> <td>DRAWN: RONALD</td> <td>11NOV21</td> </tr> <tr> <td>CHECKED: ORION</td> <td>12NOV21</td> </tr> <tr> <td>ENGINEER:</td> <td></td> </tr> <tr> <td>APPROVAL: TOMMY</td> <td>15NOV21</td> </tr> </tbody> </table>		SIGNATURES	DATE	DRAWN: RONALD	11NOV21	CHECKED: ORION	12NOV21	ENGINEER:		APPROVAL: TOMMY	15NOV21
SIGNATURES	DATE												
DRAWN: RONALD	11NOV21												
CHECKED: ORION	12NOV21												
ENGINEER:													
APPROVAL: TOMMY	15NOV21												
MATERIAL SPECIFICATIONS: WEIGHT: 27.6g		<h1>Amphenol</h1> <p>Sine Systems - www.amphenol-sine.com 44724 Morley Drive Clinton Township, MI 48036</p>											
PROCESS SPECIFICATIONS: NEXT ASSY:		CUSTOMER: THIS DRAWING IS SUPPLIED FOR INFORMATION ONLY. DESIGN FEATURES, SPECIFICATIONS AND PERFORMANCE DATA SHOWN HEREON ARE THE PROPERTY OF THE AMPHENOL CORPORATION. NO RIGHTS OF REPRODUCTION ARE IMPLIED. ALL DIMENSIONS ARE SUBJECT TO NORMAL MANUFACTURING VARIATIONS.											
		SIZE: B C- SCALE: NONE	DWG NO: AT04-12PX-P075 REVISION: A3 SHEET 2 OF 2										