



### DESCRIPTION

Honeywell's AML (Advanced Manual Line) Series of commercial grade operator interface switches offers a variety of pushbutton switches, key lock switches, paddle switches, rocker switches, and indicators. Pushbutton switches are offered as momentary action or alternate action (push-on, push-off). The AML Series switches are available with contacts for controlling logic level or power-duty electrical loads. Up to four poles are available on select AML series for control or signaling applications. When lighted switches are required, incandescent, LED, or neon lamps are available to satisfy the supply voltage requirements for the application. A wide variety of pushbutton lens, paddle switch covers, and rocker switch covers are available for lighted or unlighted applications and with or without legends. The switches and indicators snap into the panel from the front for ease of installation and require less than 44,45 mm [1.75 in] panel depth including termination.

Honeywell AML switches are UL and CSA certified as noted on page 3 of the specifications.

### DIFFERENTIATION

- A 4PDT contact option available for most AML switches
- Lamp package options for up to 250 Vac
- Key selector switches

### VALUE TO CUSTOMERS

- Well suited for power-duty and logic-level loads
- Rectangular or square front-of-panel pushbutton design
- Standard rectangular design for pushbuttons, paddle, or rocker switches

### FEATURES

- Pushbuttons, paddles, rockers, key-actuated, and indicators within AML Series for coordinated panel appearance
- Less than 1.75 inch panel depth
- Pushbuttons, paddles, and rockers furnished lighted or unlighted
- Lighted switches furnished with choice of incandescent, LED, or neon lamps dependent upon supply voltage
- Pushbuttons available with momentary or alternate action (push-on and push-off)
- Paddle, rocker, and key switches with two or three positions and maintained or momentary action
- One-, two-, or four-poles with double throw available for most switches
- Fine silver contacts for switching electrical loads, optional gold contacts for logic level applications
- AML20 Series standard-duty electrical rating or AML30 Series power-duty electrical rating (reference page 4)
- AML40 Series indicators with incandescent or LED displays
- Optional fabricated metal frames (AML61 Series) for strip mounting multiple AML switches
- Wide variety of accessories, including switch guards and panel seals
- UL and CSA certified


### POTENTIAL APPLICATIONS

- Agriculture
- Food and beverage
- Medical equipment
- Industrial equipment
- Process controls
- Oil and gas
- Military
- Aerospace
- Transportation

### PORTFOLIO

The AML Series of pushbutton switches are a portion of Honeywell's breadth of operator interface controls. Other operator interface controls are rocker switches, an extensive line of toggle switches and specialty operator controls.

# Table of Contents

Description			Pages
General Specifications			3 - 4
<b>AML20 Series and AML30 Series Unlighted Pushbuttons</b>			
AML21 Series, Standard			5 - 10
AML31 Series, Power Duty			5 - 10
<b>AML20 Series and AML30 Series Lighted Pushbuttons</b>			
AML21 Series, Standard, Incandescent Lamps			11 - 17
AML31 Series, Power Duty, Incandescent Lamps			12 - 17
AML32 Series, Power Duty, Integral Neon Lamp			18 - 19
AML22 Series, Standard, Integral LED Lamps			20 - 24
<b>AML20 Series and AML30 Series Unlighted Paddle and Rocker Switches</b>			
AML23 Series Paddle and AML24 Series Rocker, Standard			24 - 33
AML33 Series Paddle and AML34 Series Rocker, Power Duty			25 - 33
<b>AML20 Series and AML30 Series Lighted Paddle and Rocker Switches</b>			
AML23 Series Paddle and AML24 Series Rocker, Standard, Incandescent Lamps			34 - 44
AML33 Series Paddle and AML34 Series Rocker, Power Duty, Incandescent Lamp			40 - 44
AML35 Series Paddle and AML36 Series Rocker, Power Duty, Integral Neon Lamp			45 - 48
AML25 Series Paddle and AML35 Series Rocker, Standard, Integral LED Lamp			49 - 55
<b>AML20 Series Unlighted Key-Operated Selector Switches</b>			
AML27 Series Key operated switches, Standard, Two or Three position			56 - 59
<b>AML 40 Series Indicators</b>			
AML41 Series, Button-style Indicator, Incandescent Lamps			60 - 65
AML41 Series, Lens-style Indicator, Incandescent Lamps			60 - 65
AML42C Series, Pushbutton-style Indicator, Integral LED Lamp			66 - 69
AML42S series, Compact Indicator, Integral LED Lamp			66 - 69
<b>AML40 Series Annunciators</b>			
AML45 Series, Solid State LED annunciators			70 - 71
AML Pushbutton and Indicator Legend Sheet			72
AML Accessories and Replacement Parts			73

**Table 1. AML Series Specifications**

Characteristic	Parameter				
Product type	MICRO SWITCH AML Series (Advanced Manual Line) pushbutton switches and indicators				
Certifications	<b>AML20 Series switch</b>	<b>AML30 Series switch</b>	<b>AML41 Series indicator</b>	<b>AML42 Series indicator</b>	<b>AML45 Series indicator</b>
	E12252, UL1054	E12252, UL1054	E58932 UL496	–	–
	File 4442 CSA22.2 #55	File 4442 CSA22.2 #55	File 4442 CSA22.2 #43 & 55	File 4442 CSA22.2 #43 & 55	File 4442 CSA22.2 #43 & 55
Reference standards	UL 496, UL 1054, and CSA 22.2, #43 & 55				
Housing material	Glass reinforced PBT polyester				
Button material	Polycarbonate				
Panel thickness	1,5 mm to 4,75 mm [0.060 in to 0.187 in]				
Panel depth required	Less than 44,45mm (1.75 in), including termination				
Panel cutout	<b>AML20 Series switch</b>	<b>AML30 Series switch</b>	<b>AML41 Series indicator</b>	<b>AML42 Series indicator</b>	<b>AML45 Series indicator</b>
Square housing	19,0 x 19,0 mm [0.75 x 0.75 in]	–	19,0 x 19,0 mm [0.75 x 0.75 in]	19,0 x 19,0 mm [0.75 x 0.75 in]	–
Rectangular housing	19,0 x 29,0 mm [0.75 x 1.14 in]	19,0 x 29,0 mm [0.75 x 1.14 in]	19,0 x 29,0 mm [0.75 x 1.14 in]	6,35 x 19,0 mm [0.25 x 0.75 in]	8,9 x 29,0 mm [1.14 x 0.35 in]
Termination AML20 and AML40 Series	2,79 x 0, 52 mm [0.110 x 0.020 in] quick connect or solder terminals Optional, 0,64 x 0,64 mm [0.025 x 0.025 in] printed circuit board terminals				
Termination AML30 Series	4,75 x 0,52 mm [0.187 x 0.020 in] quick connect or solder terminals				
Contact options	<b>AML20 Series switch</b>	<b>AML30 Series switch</b>	<b>AML41 Series indicator</b>	<b>AML42 Series indicator</b>	<b>AML45 Series indicator</b>
Pushbutton (momentary)	Form C; 1PDT, 2PDT, 4PDT	Form X, 2PST normally open double break	–	–	–
Pushbutton (alternate action)	Form C; 1PDT, 2PDT, 4PDT	Form X, 2PST normally open double break	–	–	–
Paddles	Form C; 1PDT, 2PDT, 4PDT	Form A, 1PST, 2PST	–	–	–
Rockers	Form C; 1PDT, 2PDT, 4PDT	Form A, 1PST, 2PST,	–	–	–
Key operated selectors	Form C, 1PDT, 2PDT	–	–	–	–
Contact material	Silver alloy, optional gold contacts, or optional gold-plated silver contacts				
Lamp options	Incandescent T 1¾ wedge base, Integral LED or neon, LED T 1¾ wedge base				
Operating temperature	0 °C to 55 °C [32 °F to 131 °F]				
Electrical/mechanical life	<b>AML20 Series switch</b>	<b>AML30 Series switch</b>	<b>AML41 Series indicator</b>	<b>AML42 Series indicator</b>	<b>AML45 Series indicator</b>
Pushbutton (momentary)	6,000 cycles	6,000 cycles	–	–	–
Pushbutton (alternate action)	6,000 cycles	6,000 cycles	–	–	–
Paddles	6,000 cycles	6,000 cycles	–	–	–
Rockers	6,000 cycles	6,000 cycles	–	–	–
Key operated selectors	6,000 cycles	–	–	–	–

**Table 2. AML20 Series Electrical Ratings (Standard)**

Contact Material	Voltage	Current (amps)	Load type
Silver or gold-plated silver	24 Vdc	2	Resistive
	125 Vac	3	Inductive, 0.75 PF
	250 Vac	2	Inductive, 0.75 PF
Gold	125 Vac/Vdc	0.1	Resistive

**Table 3. AML30 Series Electrical Ratings (Power Duty)**

Switch type (silver contacts)	Voltage	Current (amps)	Load type
Pushbuttons	125/250 Vac	10	Inductive, 0.6 PF
Paddles	125/250 Vac	15	Inductive, 0.6 PF
Rockers	125/250 Vac	15	Inductive, 0.6 PF



**Operator with Integral Contact Block** (see Tables 4 and 5)



**Button** (see Table 6)



**Complete Unit**



- 0.110 in x 0.020 in quick connect or solder terminals

**Table 4. AML21 Series Unlighted Pushbutton Catalog Listings**

		Standard Black Bezel (1,52 mm [0.06 in] above panel)	
Circuitry, Form C	Contact Material	Square Housing	Rectangular Housing
1PDT momentary	Silver	AML21BBA2AA	AML21EBA2AA
2PDT momentary	Silver	AML21BBA2AC	AML21EBA2AC
4PDT momentary	Silver	AML21BBA2CC	AML21EBA2CC
1PDT alt-action	Silver	AML21BBA2AB	AML21EBA2AB
2PDT alt-action	Silver	AML21BBA2AD	AML21EBA2AD
4PDT alt-action	Silver	AML21BBA2CD	AML21EBA2CD
1PDT momentary	Gold	AML21BBA2BA	AML21EBA2BA
2PDT momentary	Gold	AML21BBA2BC	AML21EBA2BC
4PDT momentary	Gold	-	AML21EBA2DC
1PDT alt-action	Gold	AML21BBA2BB	-
2PDT alt-action	Gold	AML21BBA2BD	AML21EBA2BD
1PDT momentary	Gold-plated silver contacts	AML21BBA2EA	-
2PDT momentary	Gold-plated silver contacts	AML21BBA2EC	-

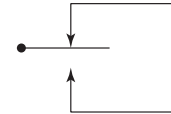
		Full Guard Black Bezel (5,0 mm [0.19 in] above panel)	
Circuitry, Form C	Contact Material	Square Housing	Rectangular Housing
1PDT momentary	Silver	AML21HBA2AA	AML21KBA2AA
2PDT momentary	Silver	AML21HBA2AC	AML21KBA2AC
1PDT alt-action	Silver	AML21HBA2AB	-
2PDT alt-action	Silver	AML21HBA2AD	AML21KBA2AD
1PDT momentary	Gold	AML21HBA2BA	AML21KBA2BA
2PDT momentary	Gold	AML21HBA2BC	-

**Table 5. AML31 Series Unlighted Power-duty Pushbutton Catalog Listings<sup>1</sup>**

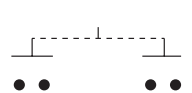
		Standard Black Bezel (1,52 mm [0.06 in] above panel)
Circuitry, Form X	Contact Material	Rectangular Housing
2PST normally open momentary	Silver	AML31EBA4AC
2PST normally open alt-action	Silver	AML31EBA4AD

<sup>1</sup>All "power-duty" pushbutton, paddle, and rocker switches (AML30 Series) have 0.187 in x 0.020 in termination

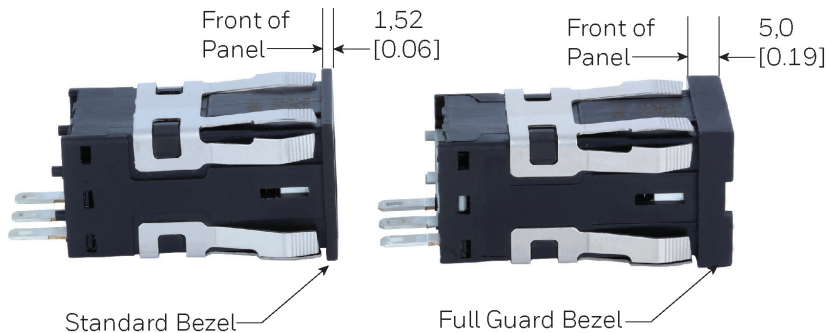
**Form C Circuitry (1, 2, or 4 Poles)**



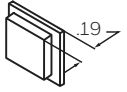
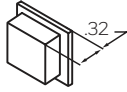
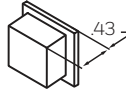
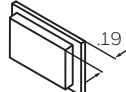
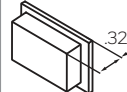
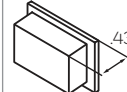
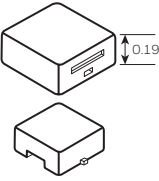
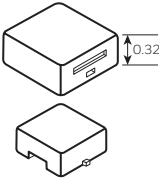
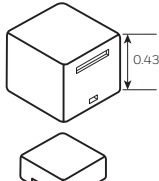
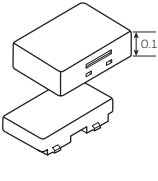
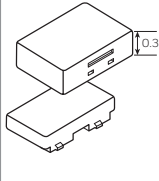
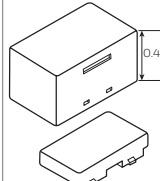
**Form X (2 Poles) Circuitry**



Difference between standard bezel and full guard bezel dimensions.

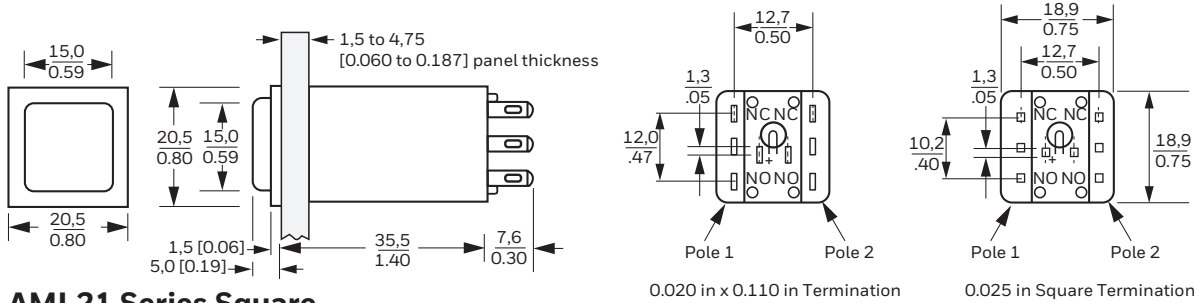


**Table 6. AML51 Series Buttons without Legends for AML21 & AML31 Series Pushbuttons\*\***

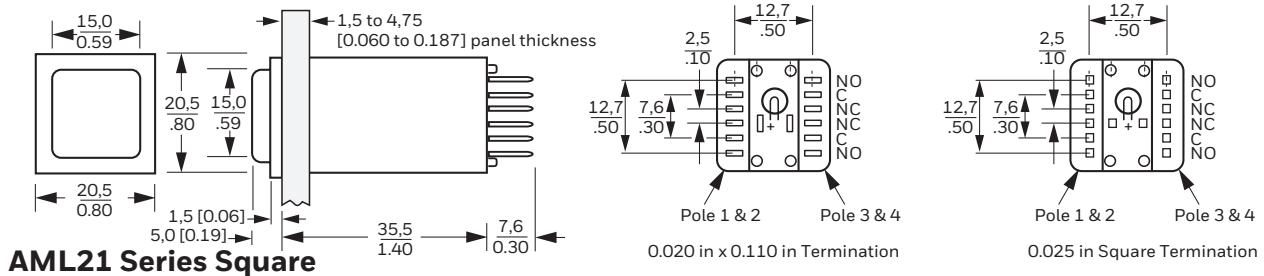
Button Color	AML51 Buttons for Square Housing			AML51 Buttons for Rectangular Housing		
	AML51-C (Standard) 0.19 in button height	AML51-A (Optional) 0.32 in button height	AML51-B (Optional) 0.43 in button height	AML51-F (Standard) 0.19 in button height	AML51-H (Optional) 0.32 in button height	AML51-E (Optional) 0.43 in button height
<b>One piece button</b>						
Red	AML51-C10R	AML51-A10R	AML51-B10R	AML51-F10R	AML51-H10R	AML51-E10R
Yellow	AML51-C10Y	AML51-A10Y	AML51-B10Y	AML51-F10Y	-	-
Green	AML51-C10G	AML51-A10G	-	AML51-F10G	AML51-H10G	-
Blue	AML51-C10B	AML51-A10B	-	AML51-F10B	-	-
White	AML51-C10W	AML51-A10W	AML51-B10W	AML51-F10W	AML51-H10W	AML51-E10W
Black	AML51-C10K	AML51-A10K	-	AML51-F10K	-	-
Gray	AML51-C10L	AML51-A10L	-	AML51-F10L	-	-
Amber	AML51-C10A	AML51-A10A	AML51-B10A	AML51-F10A	AML51-H10A	-
<b>Two piece button (clear cap &amp; color insert)</b>						
Red	AML51-C11R	-	-	AML51-F11R	AML51-H11R	-
Yellow	AML51-C11Y	-	-	AML51-F11Y	-	-
Green	AML51-C11G	-	-	AML51-F11G	AML51-H11G	-
Blue	AML51-C11B	-	-	AML51-F11B	-	-
White	AML51-C11W	AML51-A11W	-	AML51-F11W	-	-
Amber	-	-	-	AML51-F11A	AML51-H11A	-

\*\*For AML51 Series Buttons Style C, A, B, F, H, or E from table above with legends refer to Figure 52

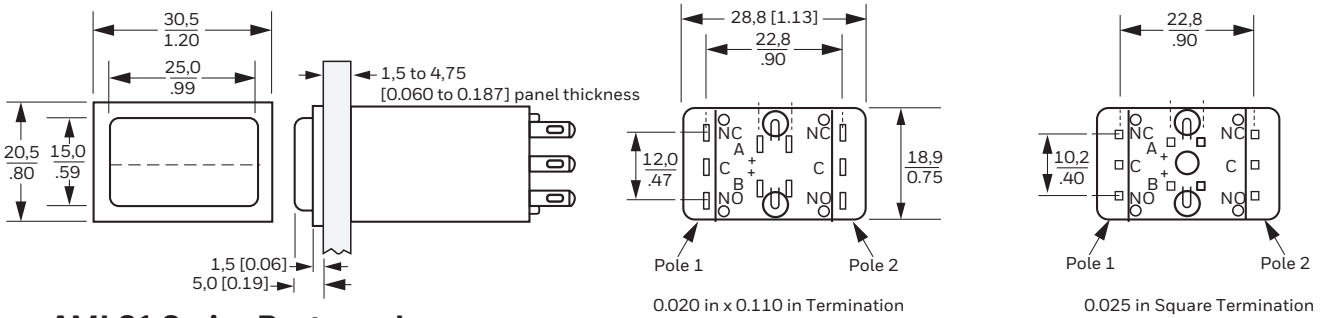
Figure 1. AML21 and AML31 Series Dimensions, mm [in] or mm/in



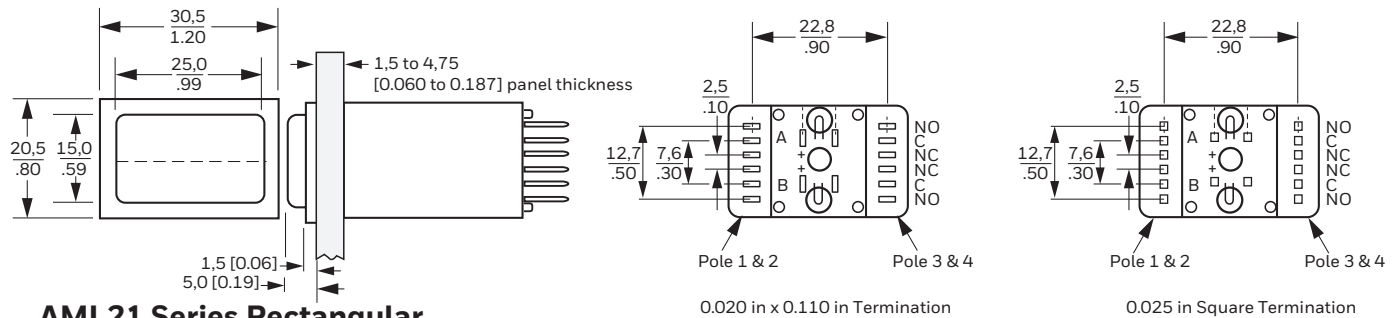
AML21 Series Square



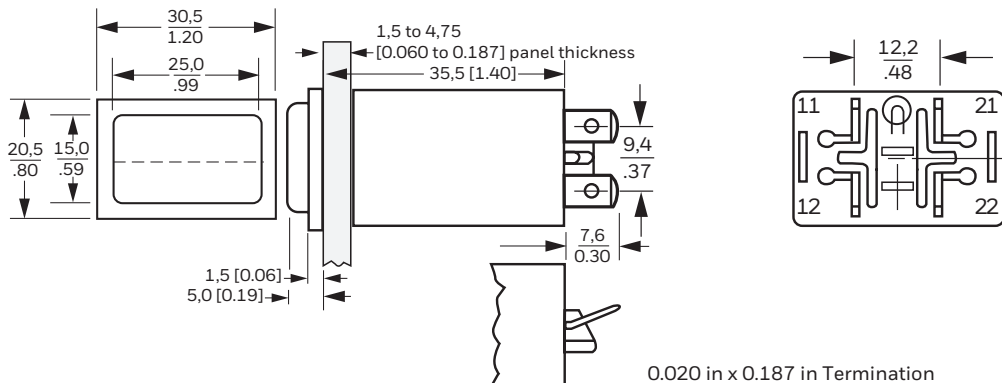
AML21 Series Square



AML21 Series Rectangular



AML21 Series Rectangular



AML31 Series Rectangular

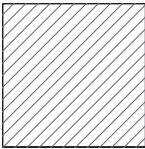
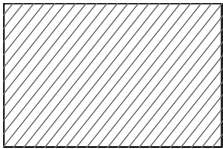
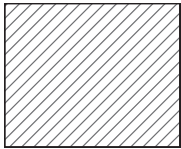
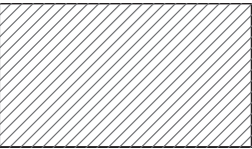
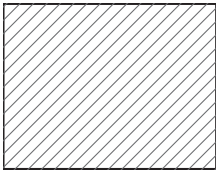
NOTE: Top of full guard bezel housings are 4,8 mm [0.19] from panel

Figure 2. AML21 Series Unlighted Pushbutton Nomenclature

AML21B		B	A	2	AA
Housing		Bezel Color	Incandescent Lamp Type	Terminal Type	Number of Poles & Contact Material
STANDARD BEZEL		B Black	A No lamp circuit	2 2,8 mm x 0,5 mm [0.110 in x 0.020 in] Quick-connect or Solder	AA 1PDT, Momentary
AML21B	Square, unlighted				
AML21E	Rectangular, unlighted			3 0,64 mm x 0,64 mm [0.025 in x 0.025 in] Push-on or Printed Ckt.	AC 2PDT, Momentary
FULL-GUARD BEZEL					CC 4PDT, Momentary
AML21H	Square, unlighted				AB 1PDT, Alt-action (Push-on, Push-off)
AML21K	Rectangular, unlighted				AD 2PDT, Alt-action (Push-on, Push-off)
					CD 4PDT, Alt-action (Push-on, Push-off)
					BA 1PDT, Momentary
					BC 2PDT, Momentary
					DC 4PDT, Momentary
					BB 1PDT, Alt-action (Push-on, Push-off)
					BD 2PDT, Alt-action (Push-on, Push-off)
					DD 4PDT, Alt-action (Push-on, Push-off)
					EA 1PDT, Momentary
					EC 2PDT, Momentary
					EB 1PDT, Alt-action (Push-on, Push-off)
					ED 2PDT, Alt-action (Push-on, Push-off)

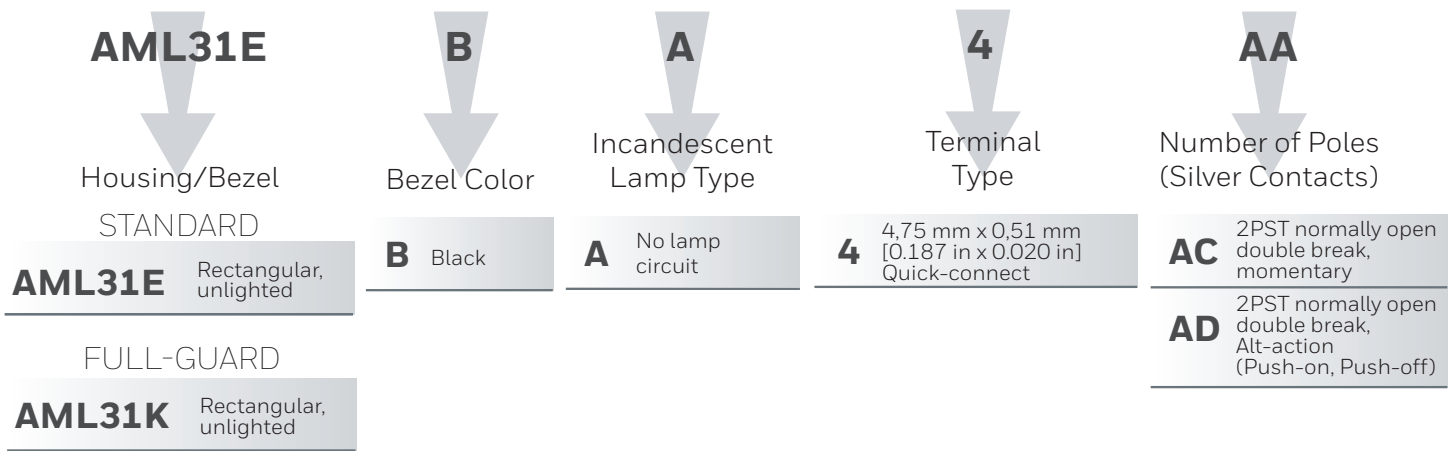
NOTE: Not all combinations of model codes are available.  
Please contact your Honeywell provider/representative for assistance.

### Panel Cutouts for Single Station, Front-of-Panel Mounting

WITHOUT BARRIERS		WITH SHORT BARRIERS <sup>1</sup>		WITH LONG BARRIERS <sup>1</sup>
				
19,05 Square [0.750]	28,98 [1.141] x 19,05 [0.750]	23,25 [0.915] x 19,05 [0.750]	33,27 [1.310] x 19,05 [0.750]	28,98 [1.141] x 23,25 [0.915]

<sup>1</sup> Table 47 describes barrier options.  
Barriers are designed to prevent inadvertent actuation of adjacent-mounted switches.

**Figure 3. AML31 Series Unlighted Power-duty Pushbuttons Nomenclature**



NOTE: Not all combinations of model codes are available. Please contact your Honeywell provider/representative for assistance.

**Figure 4. AML51 Buttons for AML21 Switches, AML31 Switches and AML41 Indicators Nomenclature**

For incandescent lighted or unlighted pushbuttons and indicators with pushbutton style displays

	<b>AML51-C</b> Pushbutton Style Cap Housing	<b>11</b> Display Type	<b>R</b> Full Color or 1 <sup>st</sup> Color Split	2 <sup>nd</sup> Color Split (if required)
<b>SQUARE</b>	<b>AML51-C</b> 0.19 inch button height	<b>10</b> Transmitted color, one-piece color cap (no legend)	<b>R</b> Red	<b>R</b> Red
	<b>AML51-A</b> 0.32 inch button height	<b>20</b> Transmitted color, one-piece color cap (legend on cap)	<b>Y</b> Yellow	<b>Y</b> Yellow
	<b>AML51-B*</b> 0.43 inch button height	<b>11</b> Transmitted color, clear cap with color insert (no legend)	<b>G</b> Green	<b>G</b> Green
	<b>AML51-D</b> 0.19 inch button height with split for AML41 two lamp indicator	<b>21</b> Transmitted color, clear cap with color insert (Legend on insert)	<b>B</b> Blue	<b>B</b> Blue
	<b>AML51-F</b> 0.19 inch button height	<b>30</b> Dead front (smoke gray cap with color insert)	<b>W</b> *** White	<b>W</b> *** White
<b>RECTANGULAR</b>	<b>AML51-H</b> 0.32 inch button height	<b>50</b> ***Projected color (white cap and color insert)	<b>K</b> Black	<b>K</b> Black
	<b>AML51-E*</b> 0.43 inch button height		<b>L</b> Gray	<b>L</b> Gray
	<b>AML51-G</b> 0.19 inch button height for 2 lamps - split along long axis		<b>A</b> **** Amber	<b>A</b> **** Amber
	<b>AML51-N**</b> 0.32 inch button height for 2 lamps - split along long axis			

NOTE: Not all combinations of model codes are available.  
 Please contact your Honeywell provider/representative for assistance  
 Note: Dimensions include the 0.06 inch standard bezel  
 Note: Black and gray buttons not recommended for lighted displays  
 \*Available with transmitted color (10) only  
 \*\*Not available with transmitted color (10)  
 \*\*\*Insert is clear when display type (50) is specified with white(W) color  
 \*\*\*\*Available with display type "transmitted color" and "dead front" only

**Operator with Integral Contact Block**

(see Tables 7-10)



**Button** (see Table 11)



**Complete Unit**



- 0.110 in x 0.020 in quick connect or solder terminals
- Replaceable Incandescent Lamp Type (T-1 3/4 wedge base)

**Table 7. AML21 Series Lighted Pushbutton Catalog Listings**

Circuitry, Form C	Contact Material	Lamp Type	Standard Black Bezel (1,52 mm [0.06 in] above panel)		
			Square Housing 1 lamp ckt	Rectangular Housing, 1 lamp ckt	Rectangular Housing, 2 lamp circuits
1PDT momentary	Silver	No lamp provided	AML21CBA2AA	AML21FBA2AA	AML21GBA2AA
1PDT momentary	Silver	14 V lamp (#73)	AML21CBC2AA	-	-
1PDT momentary	Silver	28 V lamp (#85)	AML21CBE2AA	AML21FBE2AA	AML21GBE2AA
2PDT momentary	Silver	No lamp provided	AML21CBA2AC	AML21FBA2AC	AML21GBA2AC
2PDT momentary	Silver	14 V lamp (#73)	AML21CBC2AC	AML21FBC2AC	AML21GBC2AC
2PDT momentary	Silver	28 V lamp (#85)	AML21CBE2AC	AML21FBE2AC	AML21GBE2AC
4PDT momentary	Silver	No lamp provided	AML21CBA2CC	-	AML21GBA2CC
4PDT momentary	Silver	28 V lamp (#85)	AML21CBE2CC	AML21FBE2CC	AML21GBE2CC
1PDT alt-action	Silver	No lamp provided	AML21CBA2AB	AML21FBA2AB	AML21GBA2AB
1PDT alt-action	Silver	28 V lamp (#85)	AML21CBE2AB	AML21FBE2AB	-
2PDT alt-action	Silver	No lamp provided	AML21CBA2AD	AML21FBA2AD	AML21GBA2AD
2PDT alt-action	Silver	14 V lamp (#73)	AML21CBC2AD	-	AML21GBC2AD
2PDT alt-action	Silver	28 V lamp (#85)	AML21CBE2AD	AML21FBE2AD	AML21GBE2AD
4PDT alt-action	Silver	No lamp provided	AML21CBA2CD	-	AML21GBA2CD
4PDT alt-action	Silver	14 V lamp (#73)	-	-	AML21GBC2CD
4PDT alt-action	Silver	28 V lamp (#85)	AML21CBE2CD	-	-
1PDT momentary	Gold	No lamp provided	AML21CBA2BA	AML21FBA2BA	AML21GBA2BA
1PDT momentary	Gold	28 V lamp (#85)	AML21CBE2BA	AML21FBE2BA	-
2PDT momentary	Gold	No lamp provided	AML21CBA2BC	AML21FBA2BC	AML21GBA2BC
2PDT momentary	Gold	28 V lamp (#85)	AML21CBE2BC	AML21FBE2BC	-
4PDT momentary	Gold	28 V lamp (#85)	AML21CBE2DC	-	-
1PDT alt-action	Gold	No lamp provided	AML21CBA2BB	-	AML21GBA2BB
2PDT alt-action	Gold	No lamp provided	AML21CBA2BD	AML21FBA2BD	AML21GBA2BD
2PDT alt-action	Gold	28 V lamp (#85)	AML21CBE2BD	-	-
4PDT alt-action	Gold	No lamp provided	AML21CBA2DD	AML21FBA2DD	AML21GBA2DD
4PDT alt-action	Gold	28 V lamp (#85)	-	-	AML21GBE2DD
2PDT momentary	Gold-plated silver contacts	No lamp provided	-	-	AML21GBA2EC
2PDT alt-action	Gold-plated silver contacts	28 V lamp (#85)	AML21CBE2ED	-	-

**Table 8. AML21 Series Lighted Pushbutton Catalog Listings**

			Full Guard Black Bezel (5,0 mm [0.19 in] above panel)		
Circuitry, Form C	Contact Material	Lamp Type	Square Housing 1 lamp ckt	Rectangular Housing, 1 lamp ckt	Rectangular Housing, 2 lamp circuits
1PDT momentary	Silver	No lamp provided	–	AML21LBA2AA	–
1PDT momentary	Silver	28 V lamp (#85)	AML21JBE2AA	–	AML21MBE2AA
2PDT momentary	Silver	No lamp provided	AML21JBA2AC	AML21LBA2AC	–
2PDT momentary	Silver	28 V lamp (#85)	AML21JBE2AC	AML21LBE2AC	AML21MBE2AC
1PDT alt-action	Silver	28 V lamp (#85)	–	–	AML21MBE2AB
2PDT alt-action	Silver	No lamp provided	AML21JBA2AD	AML21LBA2AD	AML21MBA2AD
2PDT alt-action	Silver	28 V lamp (#85)	AML21JBE2AD	–	AML21MBE2AD
4PDT alt-action	Silver	28 V lamp (#85)	AML21JBE2CD	–	–
1PDT momentary	Gold	No lamp provided	AML21JBA2BA	AML21LBA2BA	AML21MBA2BA
2PDT momentary	Gold	No lamp provided	AML21JBA2BC	–	–
1PDT momentary	Gold-plated silver contacts	28 V lamp (#85)	–	AML21LBE2EA	–

Note: AML21 Series Switches require a square or rectangular button from table 11

**Table 9. AML31 Series Lighted Power-Duty Pushbutton Catalog Listings<sup>1</sup>**

			Standard Black Bezel (1,52 mm [0.06 in] above panel)
Circuitry, Form X	Contact Material	Lamp Type	Rectangular Housing, 1 lamp ckt
2PST normally open momentary (Form X)	Silver	No lamp provided	AML31FBA4AC
2PST normally open momentary (Form X)	Silver	6 V lamp (#86)	AML31FBB4AC
2PST normally open momentary (Form X)	Silver	28 V lamp (#85)	AML31FBE4AC
2PST normally open alt-action (Form X)	Silver	No lamp provided	AML31FBA4AD
2PST normally open alt-action (Form X)	Silver	28 V lamp (#85)	AML31FBE4AD

Note: AML31 Series Switches require a rectangular button from table 11

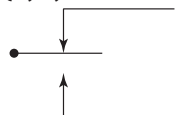
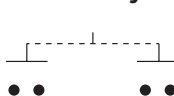
<sup>1</sup>All “power-duty” pushbutton, paddle, and rocker switches (AML30 Series) have 0.187 in x 0.020 in termination

**Table 10. AML31 Series Lighted Power-Duty Pushbutton Catalog Listings<sup>1</sup>**

			Full Guard Black Bezel (5,0 mm [0.19 in] above panel)
Circuitry, Form X	Contact Material	Lamp Type	Rectangular Housing, 1 lamp ckt
2PST normally open alt-action (Form X)	Silver	14 V lamp (#73)	AML31LBC4AD

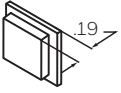
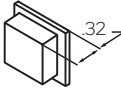
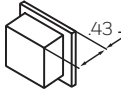
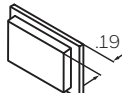
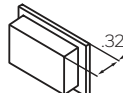
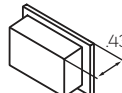
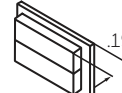
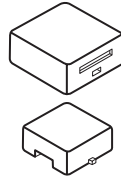
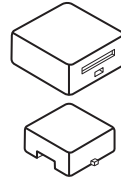
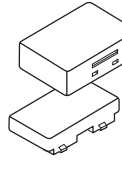
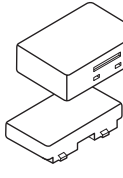
Note: AML31 Series Switches require a rectangular button from table 11

<sup>1</sup>All “power-duty” pushbutton, paddle, and rocker switches (AML30 Series) have 0.187 in x 0.020 in termination

**Form C Circuitry  
(1, 2, or 4 Poles)****Form X (2 Poles)  
Circuitry**



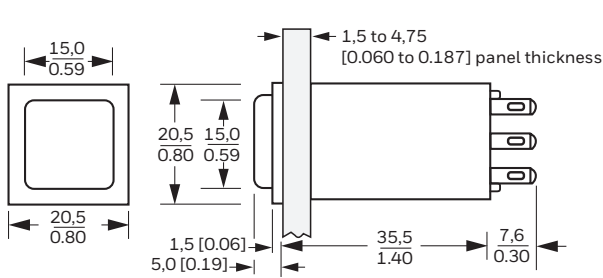
**Table 11. AML51 Series Buttons without Legends for AML21 & AML31 Series Lighted Pushbuttons\*\***

	AML51 Buttons for Square Housing			AML51 Buttons for Rectangular Housing			
Button Color	AML51-C (Standard) 0.19 in button height	AML51-A (Optional) 0.32 in button height	AML51-B (Optional) 0.43 in button height	AML51-F Series (Standard) 0.19 in button height	AML51-H Series (Optional) 0.32 in button height	AML51-E Series (Optional) 0.43 in button height	AML51-G Series (2 lamp circuits) 0.19 in button height
<b>One piece button</b>							
Red	AML51-C10R	AML51-A10R	AML51-B10R	AML51-F10R	AML51-H10R	AML51-E10R	AML51-G10RR
Yellow	AML51-C10Y	AML51-A10Y	AML51-B10Y	AML51-F10Y	-	-	-
Green	AML51-C10G	AML51-A10G	-	AML51-F10G	AML51-H10G	-	-
Blue	AML51-C10B	AML51-A10B	-	AML51-F10B	--	-	-
White	AML51-C10W	AML51-A10W	AML51-B10W	AML51-F10W	AML51-H10W	AML51-E10W	AML51-G10WW
Amber	AML51-C10A	AML51-A10A	AML51-B10A	AML51-F10A	AML51-H10A	-	-
Red/Yellow	-	-	-	-	-	-	AML51-G10RY
Red/Green	-	-	-	-	-	-	AML51-G10RG
Red/White	-	-	-	-	-	-	AML51-G10RW
Yellow/Green	-	-	-	-	-	-	AML51-G10YG
Green/Yellow	-	-	-	-	-	-	AML51-G10GY
White/Red	-	-	-	-	-	-	AML51-G10WR
White/Green	-	-	-	-	-	-	AML51-G10WG
<b>Two piece button (clear cap &amp; color insert)</b>							
Red	AML51-C11R	-	-	AML51-F11R	AML51-H11R	-	-
Yellow	AML51-C11Y	-	-	AML51-F11Y	-	-	-
Green	AML51-C11G	-	-	AML51-F11G	AML51-H11G	-	-
Blue	AML51-C11B	-	-	AML51-F11B	-	-	AML51-G11BB
White	AML51-C11W	AML51-A11W	-	AML51-F11W	-	-	AML51-G11WW
Amber	-	-	-	AML51-F11A	AML51-H11A	-	-
Red/Green	-	-	-	-	-	-	AML51-G11RG
Yellow/White	-	-	-	-	-	-	AML51-G11YW
Green/Red	-	-	-	-	-	-	AML51-G11GR
<b>Dead Front, two piece button (gray cap &amp; color insert)</b>							
Red	AML51-C30R	-	-	-	AML51-H30R	-	-
Yellow	-	-	-	-	-	-	-
Green	AML51-C30G	AML51-A30G	-	-	-	-	-
Blue	-	-	-	-	-	-	-
White	AML51-C30W	AML51-A30W	-	-	-	-	-
Amber	AML51-C30A	-	-	-	-	-	-
Red/Green	-	-	-	-	-	-	AML51-G30RG
<b>Projected color, white cap and color insert*</b>							
Red	AML51-C50R	-	-	AML51-F50R	-	-	-
Yellow	AML51-C50Y	-	-	-	-	-	-
Green	AML51-C50G	-	-	AML51-F50G	-	-	-
Blue	-	-	-	-	-	-	-
White*	-	-	-	AML51-F50W	AML51-H50W	-	AML51-G50WW
Amber	AML51-C50A	-	-	-	-	-	-
White*/Blue	-	-	-	-	-	-	AML51-G50WB

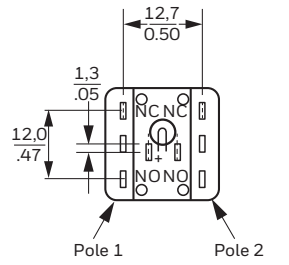
\*When projected color is white, white cap is furnished with clear insert

\*\*For AML51 Series Buttons Style C, A, B, F, H, E, or G from table above with Legends refer to Figure 52

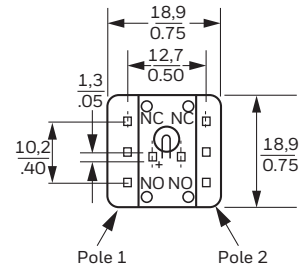
Figure 5. AML21 and AML31 Series Dimensions, mm [in] or mm/in



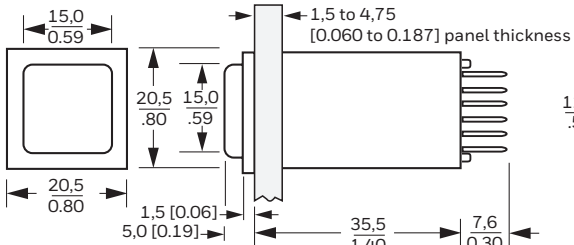
AML21 Series Square



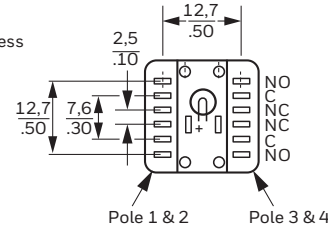
0.020 in x 0.110 in Termination



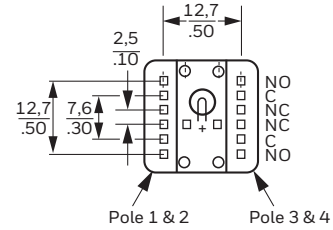
0.025 in Square Termination



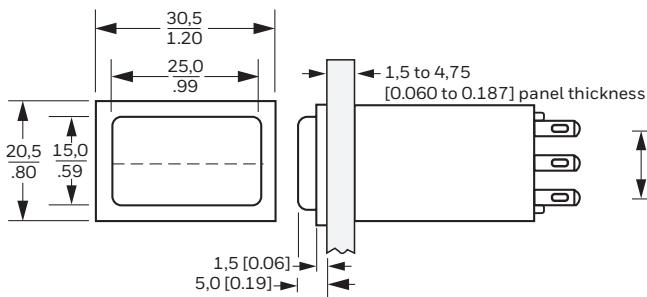
AML21 Series Square



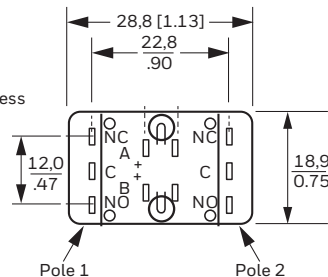
0.020 in x 0.110 in Termination



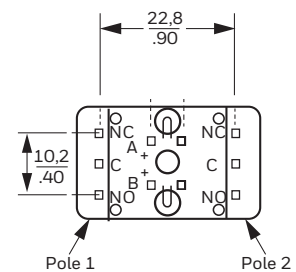
0.025 in Square Termination



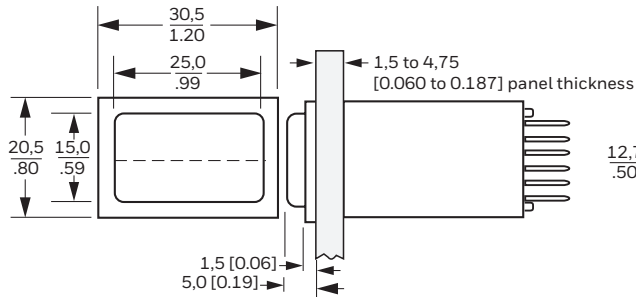
AML21 Series Rectangular



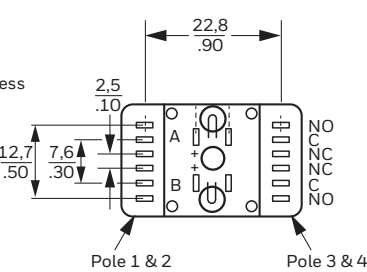
0.020 in x 0.110 in Termination



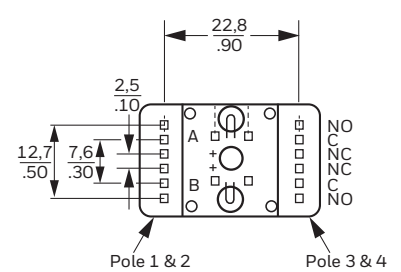
0.025 in Square Termination



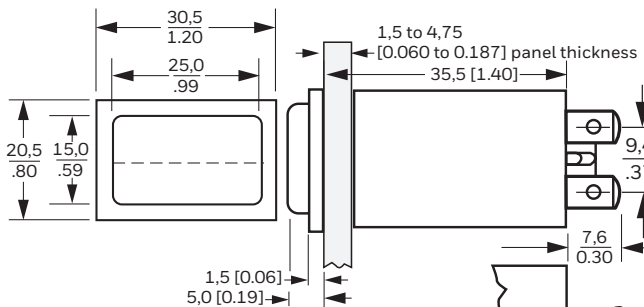
AML21 Series Rectangular



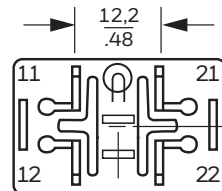
0.020 in x 0.110 in Termination



0.025 in Square Termination



AML31 Series Rectangular



0.020 in x 0.187 in Termination

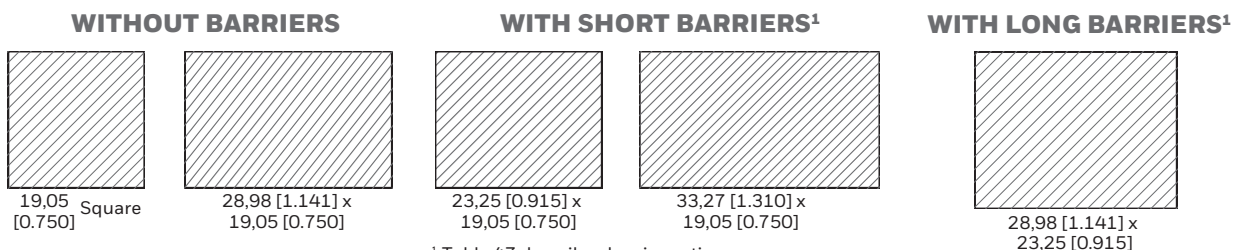
NOTE: Top of full guard bezel housings are 4.8 mm [0.19] from panel

Figure 6. AML21 Series Lighted Pushbutton Nomenclature

AML21F		B	B	2	AA
Housing		Bezel Color	Incandescent Lamp Type	Terminal Type	Number of Poles & Contact Material
STANDARD BEZEL		B Black	A No lamp provided	2 2,8 mm x 0,5 mm [0.110 in x 0.020 in] Quick-connect or Solder	AA 1PDT, Momentary
AML21C	Square, 1 lamp circuit		B 6 V Lamp (#86)	3 0,64 mm x 0,64 mm [0.025 in x 0.025 in] Push-on or Printed Ckt.	AC 2PDT, Momentary
AML21F	Rectangular, 1 lamp circuit		C 14 V Lamp (#77)	SILVER CONTACTS	CC 4PDT, Momentary
AML21G	Rectangular, 2 lamp circuits	E 28 V Lamp (#85)	AB 1PDT, Alt-action (Push-on, Push-off)		
FULL-GUARD BEZEL					AD 2PDT, Alt-action (Push-on, Push-off)
AML21J	Square, 1 lamp circuit				CD 4PDT, Alt-action (Push-on, Push-off)
AML21L	Rectangular, 1 lamp circuit				BA 1PDT, Momentary
AML21M	Rectangular, 2 lamp circuits				BC 2PDT, Momentary
					DC 4PDT, Momentary
					BB 1PDT, Alt-action (Push-on, Push-off)
					BD 2PDT, Alt-action (Push-on, Push-off)
					DD 4PDT, Alt-action (Push-on, Push-off)
					EA 1PDT, Momentary
					EC 2PDT, Momentary
					EB 1PDT, Alt-action (Push-on, Push-off)
					ED 2PDT, Alt-action (Push-on, Push-off)

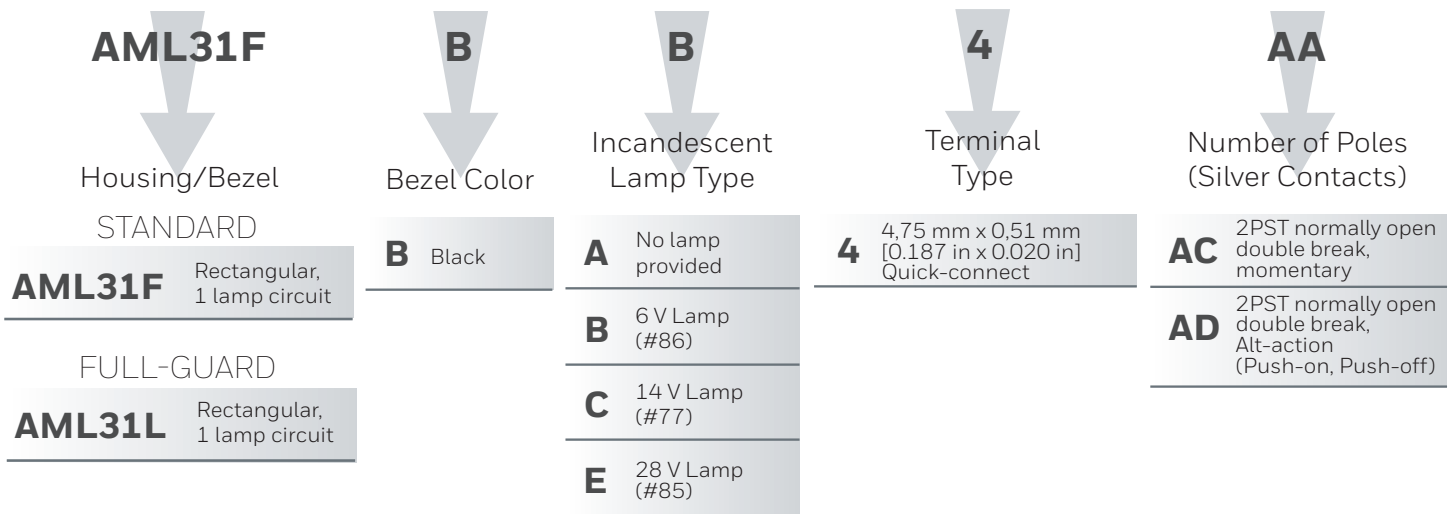
NOTE: Not all combinations of model codes are available. Please contact your Honeywell provider/representative for assistance.

Panel Cutouts for Single Station, Front-of-Panel Mounting



<sup>1</sup> Table 47 describes barrier options. Barriers are designed to prevent inadvertent actuation of adjacent-mounted switches.

Figure 7. AML31 Series Lighted Pushbutton Nomenclature



NOTE: Not all combinations of model codes are available.  
Please contact your Honeywell provider/representative for assistance.

**Figure 8. AML51 Buttons for AML21 Switches, AML31 Switches and AML41 Indicators Nomenclature**

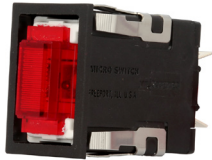
For incandescent lighted or unlighted pushbuttons and indicators with pushbutton style displays

	<b>AML51-C</b> Pushbutton Style Cap Housing	<b>11</b> Display Type	<b>R</b> Full Color or 1 <sup>st</sup> Color Split	2 <sup>nd</sup> Color Split (if required)	
<b>SQUARE</b>	<b>AML51-C</b> 0.19 inch button height	<b>10</b> Transmitted color, one-piece color cap (no legend)	<b>R</b> Red	<b>R</b> Red	
	<b>AML51-A</b> 0.32 inch button height	<b>20</b> Transmitted color, one-piece color cap (legend on cap)	<b>Y</b> Yellow	<b>Y</b> Yellow	
	<b>AML51-B*</b> 0.43 inch button height	<b>11</b> Transmitted color, clear cap with color insert (no legend)	<b>G</b> Green	<b>G</b> Green	
	<b>AML51-D</b> 0.19 inch button height with split for AML41 two lamp indicator	<b>21</b> Transmitted color, clear cap with color insert (Legend on insert)	<b>B</b> Blue	<b>B</b> Blue	
		<b>30</b> Dead front (smoke gray cap with color insert)	<b>W</b> *** White	<b>W</b> *** White	
	<b>AML51-F</b> 0.19 inch button height	<b>50</b> ***Projected color (white cap and color insert)	<b>K</b> Black	<b>K</b> Black	
<b>RECTANGULAR</b>	<b>AML51-H</b> 0.32 inch button height		<b>L</b> Gray	<b>L</b> Gray	
	<b>AML51-E*</b> 0.43 inch button height		<b>A</b> **** Amber	<b>A</b> **** Amber	
	<b>AML51-G</b> 0.19 inch button height for 2 lamps - split along long axis				
		<b>AML51-N**</b> 0.32 inch button height for 2 lamps - split along long axis			

NOTE: Not all combinations of model codes are available.  
 Please contact your Honeywell provider/representative for assistance  
 Note: Dimensions include the 0.06 inch standard bezel  
 Note: Black and gray buttons not recommended for lighted displays  
 \*Available with transmitted color (10) only  
 \*\*Not available with transmitted color (10)  
 \*\*\*Insert is clear when display type (50) is specified with white(W) color  
 \*\*\*\*Available with display type "transmitted color" and "dead front" only

**Operator with Integral Contact Block**

(see Tables 12 and 13)



**Button** (see Table 14)



**Complete Unit**



- 0.187 in x 0.020 in quick connect or solder terminals

**Table 12. AML32 Series Lighted Power-duty Pushbutton with Integral Neon Lamp Catalog Listings**

Circuitry, Form X	Contact Material	Neon Lamp, Voltage, & Color	Standard Black Bezel (1,52 mm [0.06 in] above panel)	
			Rectangular Housing; 1 Independent lamp ckt	Rectangular Housing; 1 Integral lamp ckt
2PST normally open momentary (Form X)	Silver	125 Vac, Red	AML32FBB4AC	-
2PST normally open momentary (Form X)	Silver	125 Vac, Clear	AML32FBK4AC	-
2PST normally open alt-action (Form X)	Silver	125 Vac, Red	AML32FBB4AD	AML32FBB7AD
2PST normally open alt-action (Form X)	Silver	125 Vac, Clear	AML32FBK4AD	AML32FBK7AD
2PST normally open alt-action (Form X)	Silver	125 Vac Green	-	AML32FBM7AD
2PST normally open alt-action (Form X)	Silver	250 Vac, Red	AML32FBC4AD	AML32FBC7AD
2PST normally open alt-action (Form X)	Silver	250 Vac, Clear	-	AML32FBL7AD
2PST normally open alt-action (Form X)	Silver	250 Vac, Green	AML32FBP4AD	AML32FBP7AD

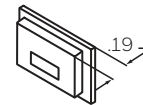
**Table 13. AML32 Series Lighted Power-duty Pushbutton with Integral Neon Lamp Catalog Listings**

Circuitry, Form X	Contact Material	Neon Lamp, Voltage, & Color	Full Guard Black Bezel (5,0 mm [0.19 in] above panel)	
			Rectangular Housing; 1 Independent lamp ckt	Rectangular Housing; 1 Integral lamp ckt
2PST normally open alt-action (Form X)	Silver	250 Vac, Red	-	AML32LBC7AD
2PST normally open alt-action (Form X)	Silver	250 Vac, Green	-	AML32LBP7AD

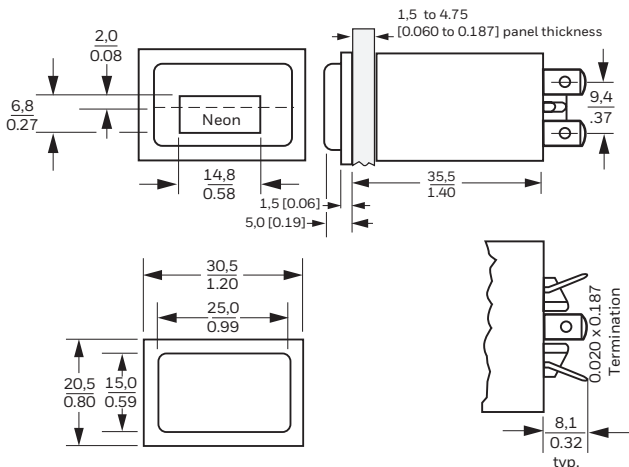
Note: AML32 Series Switches with neon lamps require a rectangular AML52-N style button in Table 14

**Table 14. AML52-N Series Rectangular Buttons for Neon Switches**

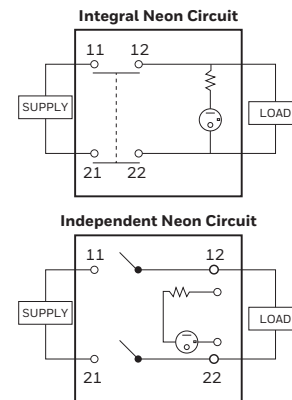
Button Color	Catalog Listing
Red	AML52-N10R
Green	AML52-N10G
Blue	AML52-N10B
White	AML52-N10W
Black	AML52-N10K



**Figure 9. AML32 Series Dimensions mm [in] or mm/in**

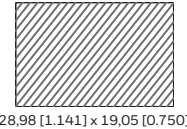


NOTE: Top of Full Guard Bezel Housings are 0.19 in from Panel

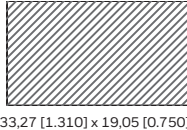


**Panel Cutouts**

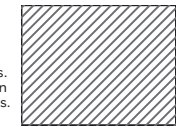
**WITHOUT BARRIERS**



**WITH SHORT BARRIERS**



**WITH LONG BARRIERS**



<sup>1</sup> Table 47 describes barrier options. Barriers are designed to prevent inadvertent actuation of adjacent-mounted switches.

Figure 10. AML32 Series Lighted Neon Pushbutton Nomenclature

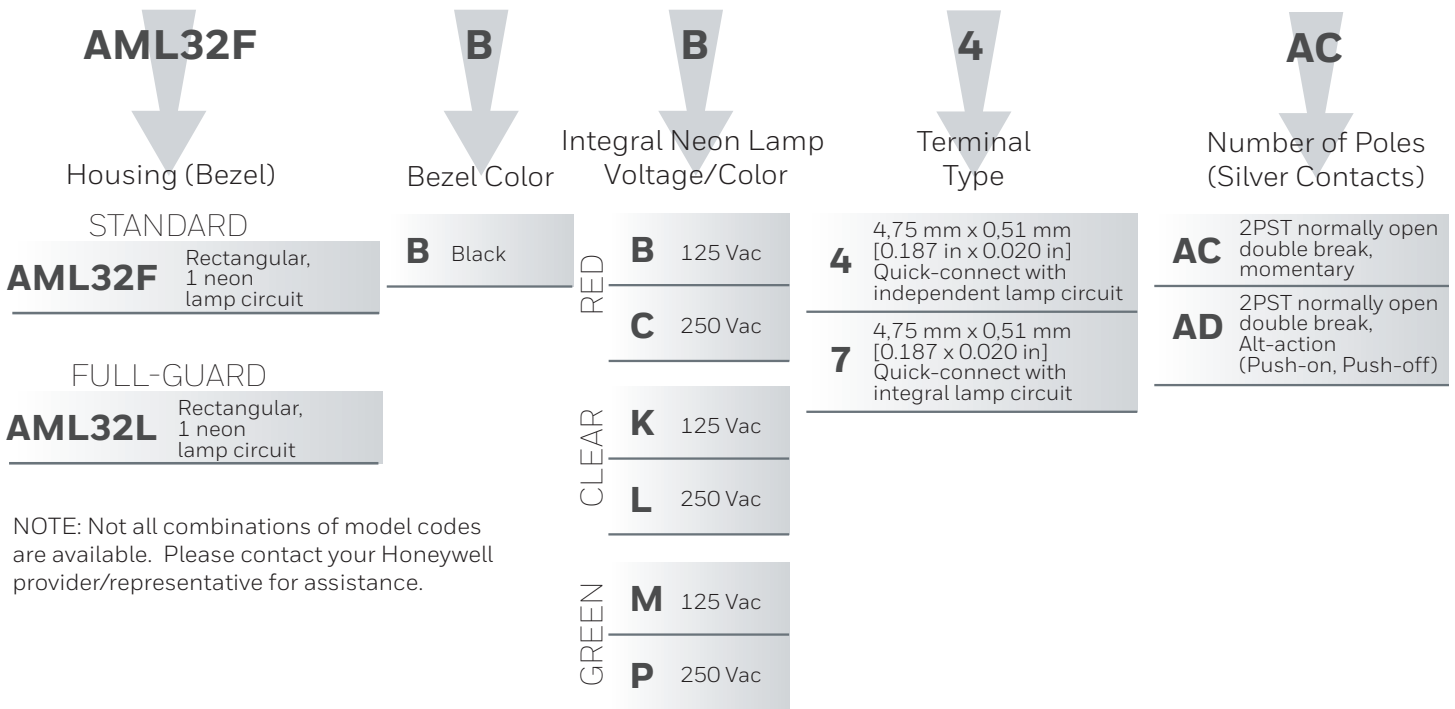
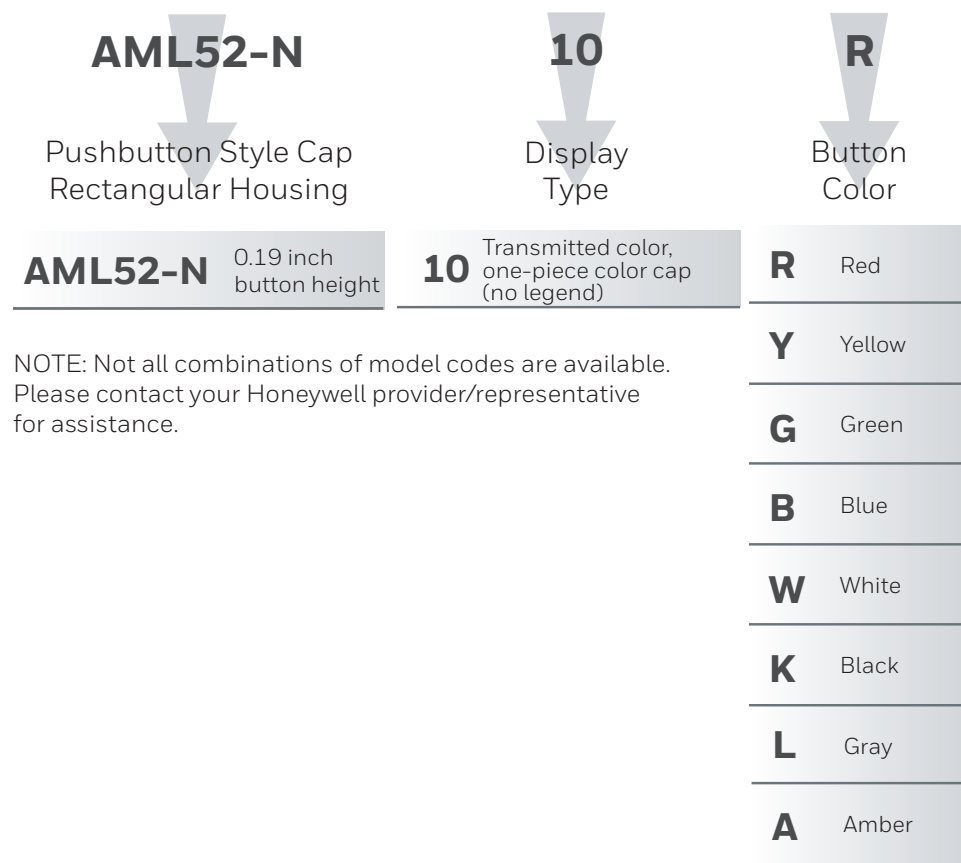


Figure 11. AML52-N Buttons for AML32 Switches Nomenclature



**Operator with Integral Contact Block**

(see Tables 15 &amp; 16)

**Button** (see Table 17)**Complete Unit**

- 0.110 in x 0.020 in quick connect or solder terminals

**Table 15. AML22 Series Lighted Pushbuttons with Integral LED Catalog Listings**

Circuitry, Form C	Contact Material	LED Description		Square Housing	
		Supply Voltage (dc)	Color	1 LED	1 LED with Diode Protection**
1PDT momentary	Silver	V*	Red	AML22CBB2AA	-
1PDT momentary	Gold	V*	Red	AML22CBB2BA	-
1PDT momentary	Silver	V*	Yellow	AML22CBH2AA	-
1PDT momentary	Silver	V*	Green	AML22CBR2AA	-
1PDT momentary	Gold	V*	Green	AML22CBR2BA	AML22CBR8BA
1PDT momentary	Silver	5 V	Red	AML22CBC2AA	AML22CBC8AA
1PDT momentary	Silver	5 V	Yellow	AML22CBJ2AA	-
1PDT momentary	Silver	5 V	Green	AML22CBS2AA	-
1PDT momentary	Gold	5 V	Green	AML22CBS2BA	-
1PDT momentary	Silver	15 V	Red	AML22CBE2AA	-
1PDT momentary	Silver	15 V	Yellow	AML22CBL2AA	-
1PDT momentary	Silver	15 V	Green	AML22CBW2AA	-
1PDT momentary	Gold	15 V	Green	-	AML22CBW8BA
1PDT momentary	Silver	24 V	Red	AML22CBF2AA	-
1PDT momentary	Gold	24 V	Red	AML22CBF2BA	-
1PDT momentary	Gold-Plated Silver Contacts	24 V	Red	AML22CBF2EA	-
1PDT momentary	Silver	24 V	Yellow	AML22CBM2AA	-
1PDT momentary	Gold	24 V	Yellow	AML22CBM2BA	AML22CBM8BA
1PDT momentary	Gold-Plated Silver Contacts	24 V	Yellow	AML22CBM2EA	-
1PDT momentary	Silver	24 V	Green	AML22CBX2AA	AML22CBX8AA
1PDT momentary	Gold	24 V	Green	AML22CBX2BA	-
2PDT momentary	Silver	V*	Red	AML22CBB2AC	-
2PDT momentary	Gold	V*	Red	-	AML22CBB8BC
2PDT momentary	Silver	V*	Yellow	AML22CBH2AC	-
2PDT momentary	Silver	V*	Green	AML22CBR2AC	AML22CBR8AC
2PDT momentary	Gold	V*	Green	AML22CBR2BC	-
2PDT momentary	Silver	5 V	Red	AML22CBC2AC	-
2PDT momentary	Gold	5 V	Red	AML22CBC2BC	-
2PDT momentary	Silver	5 V	Yellow	AML22CBJ2AC	-
2PDT momentary	Silver	5 V	Green	AML22CBS2AC	AML22CBS8AC
2PDT momentary	Silver	15 V	Red	AML22CBE2AC	-
2PDT momentary	Silver	24 V	Red	AML22CBF2AC	AML22CBF8AC
2PDT momentary	Gold-Plated Silver Contacts	24 V	Red	AML22CBF2EC	-
2PDT momentary	Silver	24 V	Yellow	AML22CBM2AC	-
2PDT momentary	Gold	24 V	Yellow	AML22CBM2BC	-
2PDT momentary	Gold-Plated Silver Contacts	24 V	Yellow	AML22CBM2EC	-
2PDT momentary	Silver	24 V	Green	AML22CBX2AC	AML22CBX8AC
2PDT momentary	Gold	24 V	Green	AML22CBX2BC	AML22CBX8BC

\*The LED does not include an internal resistor. A suitable external resistor must be added to the LED circuit for a nominal current of 20 mA

\*\*Reference Table 48 for information



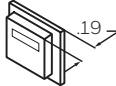
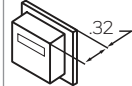
Table 16. AML22 Series Lighted Pushbuttons with Integral LED Catalog Listings

Circuitry, Form C	Contact Material	LED Description		Square Housing	
		Supply Voltage (dc)	Color	1 LED	1 LED with Diode Protection**
4PDT momentary	Silver	V*	Red	-	AML22CBB8CC
4PDT momentary	Silver	5 V	Green	AML22CBS2CC	-
4PDT momentary	Gold	24 V	Red	-	AML22CBF8DC
4PDT momentary	Silver	24 V	Yellow	AML22CBM2CC	-
4PDT momentary	Gold	24 V	Green	-	AML22CBX8DC
1PDT alt-action	Silver	V*	Red	AML22CBB2AB	-
1PDT alt-action	Silver	V*	Yellow	AML22CBH2AB	-
1PDT alt-action	Silver	V*	Green	AML22CBB2AB	-
1PDT alt-action	Gold-Plated Silver Contacts	V*	Green	AML22CBB2EB	-
1PDT alt-action	Silver	5 V	Red	AML22CBC2AB	-
1PDT alt-action	Silver	5 V	Green	AML22CBS2AB	AML22CBS8AB
1PDT alt-action	Gold-Plated Silver Contacts	5 V	Green	AML22CBS2EB	-
1PDT alt-action	Silver	15 V	Yellow	AML22CBL2AB	-
1PDT alt-action	Silver	15 V	Green	AML22CBW2AB	-
1PDT alt-action	Silver	24 V	Red	AML22CBF2AB	-
1PDT alt-action	Gold	24 V	Red	AML22CBF2BB	-
1PDT alt-action	Silver	24 V	Yellow	AML22CBM2AB	AML22CBM8AB
1PDT alt-action	Gold	24 V	Yellow	AML22CBM2BB	-
1PDT alt-action	Silver	24 V	Green	AML22CBX2AB	-
2PDT alt-action	Silver	V*	Red	AML22CBB2AD	AML22CBB8AD
2PDT alt-action	Silver	V*	Yellow	AML22CBH2AD	-
2PDT alt-action	Gold-Plated Silver Contacts	V*	Yellow	AML22CBH2ED	-
2PDT alt-action	Silver	V*	Green	AML22CBB2AD	AML22CBB8AD
2PDT alt-action	Gold	V*	Green	AML22CBB2BD	-
2PDT alt-action	Silver	5 V	Red	AML22CBC2AD	-
2PDT alt-action	Silver	5 V	Yellow	AML22CBJ2AD	-
2PDT alt-action	Silver	5 V	Green	AML22CBS2AD	AML22CBS8AD
2PDT alt-action	Gold	5 V	Green	AML22CBS2BD	AML22CBS8BD
2PDT alt-action	Silver	15 V	Red	AML22CBE2AD	-
2PDT alt-action	Silver	15 V	Yellow	AML22CBL2AD	-
2PDT alt-action	Silver	15 V	Green	AML22CBW2AD	-
2PDT alt-action	Silver	24 V	Red	AML22CBF2AD	AML22CBF8AD
2PDT alt-action	Silver	24 V	Yellow	AML22CBM2AD	-
2PDT alt-action	Gold	24 V	Yellow	AML22CBM2BD	-
2PDT alt-action	Silver	24 V	Green	AML22CBX2AD	AML22CBX8AD
2PDT alt-action	Gold	24 V	Green	AML22CBX2BD	AML22CBX8BD
2PDT alt-action	Gold-Plated Silver Contacts	24 V	Green	AML22CBX2ED	-
4PDT alt-action	Silver	15 V	Yellow	AML22CBL2CD	-
4PDT alt-action	Silver	24 V	Red	AML22CBF2CD	-
4PDT alt-action	Silver	24 V	Yellow	AML22CBM2CD	-
4PDT alt-action	Gold	24 V	Yellow	-	AML22CBM8DD

\*The LED does not include an internal resistor. A suitable external resistor must be added to the LED circuit for a nominal current of 20 mA

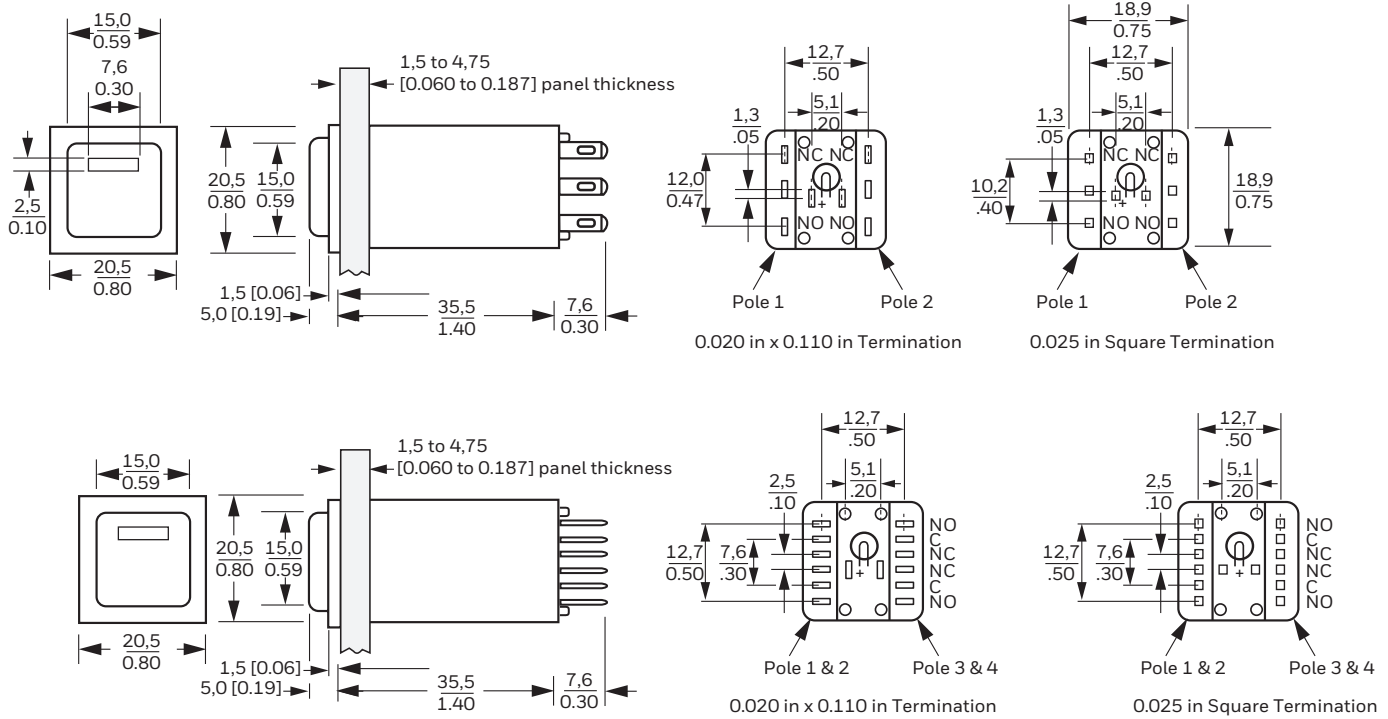
\*\*Reference Table 48 for information

**Table 17. AML52 Series Buttons without Legend for AML22 Series LED Pushbuttons\*\***

Button Color	AML52-C Series (Standard)	AML52-A Series (Optional)
One piece button		
Red	AML52-C10R	AML52-A10R
Yellow	AML52-C10Y	AML52-A10Y
Green	AML52-C10G	AML52-A10G
Blue	AML52-C10B	AML52-A10B
White	AML52-C10W	AML52-A10W
Black	AML52-C10K	AML52-A10K
Gray	AML52-C10L	-

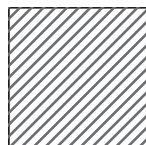
\*\*For AML52 Series LED Lighted Buttons Style C or A from table above with Legends contact the local Honeywell source

**Figure 12. AML22 Series Dimensions, mm [in] or mm/in**



**Panel Cutouts for Single Station, Front-of-Panel Mounting**

**WITHOUT BARRIERS      WITH SHORT BARRIERS<sup>1</sup>**



19,05 Square  
[0.750]



23,25 [0.915] x  
19,05 [0.750]

<sup>1</sup> Table 47 describes barrier options. Barriers are designed to prevent inadvertent actuation of adjacent-mounted switches.

**Figure 13. AML22 Series LED Lighted Pushbutton Nomenclature**

AML22C		B	B	2	AA	
Housing (Bezel)		Bezel Color		LED Color & Voltage	Terminal Type	Number of Poles & Contact Material
STANDARD		B Black		B Vdc*	2 2,8 mm x 0,5 mm [0.110 in x 0.020 in] Quick-connect or Solder	AA 1PDT, Momentary
<b>AML22C</b>	Square, 1 LED lamp circuit			C 5 Vdc	3 0,64 mm x 0,64 mm [0.025 in x 0.025 in] Push-on or Printed Ckt.	AC 2PDT, Momentary
FULL-GUARD				D 10 Vdc	8 2,8 mm x 0,5 mm [0.110 x 0.020 in] Quick-connect or solder w/ diode protection	CC 4PDT, Momentary
<b>AML22J</b>	Square, 1 LED lamp circuit			E 15 Vdc		AB 1PDT, Alt-action (Push-on, Push-off)
				F 24 Vdc	AD 2PDT, Alt-action (Push-on, Push-off)	CD 4PDT, Alt-action (Push-on, Push-off)
				H Vdc*	SILVER CONTACTS	
				J 5 Vdc	BA 1PDT, Momentary	
				K 10 Vdc	BC 2PDT, Momentary	
				L 15 Vdc	DC 4PDT, Momentary	
				M 24 Vdc	BB 1PDT, Alt-action (Push-on, Push-off)	
				R Vdc*	BD 2PDT, Alt-action (Push-on, Push-off)	
				S 5 Vdc	DD 4PDT, Alt-action (Push-on, Push-off)	
				T 10 Vdc	GOLD CONTACTS	
				W 15 Vdc	EA 1PDT, Momentary	
				X 24 Vdc	EC 2PDT, Momentary	
					EB 1PDT, Alt-action (Push-on, Push-off)	
					ED 2PDT, Alt-action (Push-on, Push-off)	

NOTE: Not all combinations of model codes are available. Please contact your Honeywell provider/representative for assistance.

\* An appropriate external series resistor must be added to the LED circuit to limit the current to a nominal 20 mA

Figure 14. AML52 Buttons for AML22 Switches Nomenclature

<b>AML52-C</b> Pushbutton Style Cap Square Housing		<b>10</b> Display Type	<b>R</b> Button Color
<b>AML52-C</b>	0.19 inch button height	<b>10</b> Transmitted color, one-piece color cap (no legend)	<b>R</b> Red
<b>AML52-A</b>	0.32 inch button height		<b>Y</b> Yellow
			<b>G</b> Green
			<b>B</b> Blue
			<b>W</b> White
			<b>K</b> Black
			<b>L</b> Gray
			<b>A</b> Amber

NOTE: Not all combinations of model codes are available. Please contact your Honeywell provider/representative for assistance.

**Operator with Integral Contact Block**

(see Tables 18-20)



**Paddle cover or Rocker**  
(see Tables 21 & 22)



**Complete Unit**



- 0.110 in x 0.020 in quick connect or solder terminals

**Table 18. Unlighted (2 Pos) AML23 Series Paddle and AML24 Series Rocker Switches Catalog Listings**

No. of Poles	Contact Material	Circuits		Paddle Switch Cat. Listings	Rocker Switch Cat. Listings
		Left Position	Right Position		
1PDT	Silver	1-2	2-3	AML23EBA2AA01	AML24EBA2AA01
	Gold	1-2	2-3	-	AML24EBA2BA01
	Silver	1-2 Mom.	2-3	-	AML24EBA2AA02
	Gold	1-2 Mom.	2-3	-	AML24EBA2BA02
	Silver	1-2	2-3 Mom.	AML23EBA2AA03	AML24EBA2AA03
	Gold	1-2	2-3 Mom.	-	AML24EBA2BA03
2PDT	Silver	1-2, 4-5	2-3, 5-6	AML23EBA2AC01	AML24EBA2AC01
	Gold	1-2, 4-5	2-3, 5-6	AML23EBA2BC01	AML24EBA2BC01
	Silver	1-2, 4-5 Mom.	2-3, 5-6	-	AML24EBA2AC02
	Silver	1-2, 4-5	2-3, 5-6 Mom.	-	AML24EBA2AC03
	Silver	1-2, 4-5	2-3, 5-6	AML23EBA2CA01*	AML24EBA2CA01*
	Silver	1-2, 4-5 Mom.	2-3, 5-6	AML23EBA2CA02*	-
4PDT	Silver	1-2, 4-5, 7-8, 10-11	2-3, 5-6, 8-9, 11-12	-	AML24EBA2CC01
	Gold	1-2, 4-5, 7-8, 10-11	2-3, 5-6, 8-9, 11-12	-	AML24EBA2DC01

① MICRO SWITCH identification on this side of switch housing

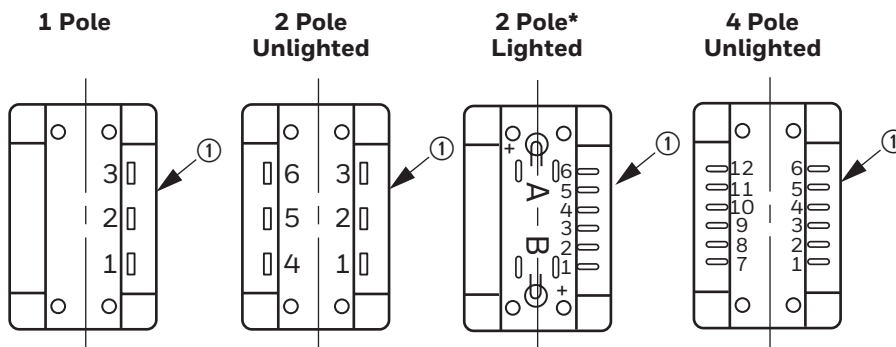
Note: All switch positions are maintained except where noted as Mom. (momentary)

Note: AML23 Series Paddle switches require AML53-E Series Cover (2 required) or AML53-T Series Cover from table 21

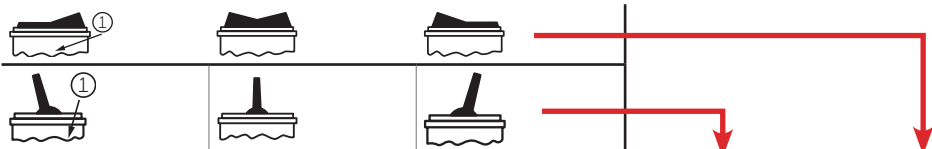
Note: AML24 Series Rocker switches require AML54-F Series Rocker Button (full rocker button) or AML54-T Series Button (2 piece button) from table 22.

\*These two-pole unlighted switches have the six (6) switch terminals inline on rear of housing

**Switch Terminal Location**



**Table 19. Unlighted (3 Pos) AML23 Series Paddle and AML24 Series Rocker Switches Catalog Listings**



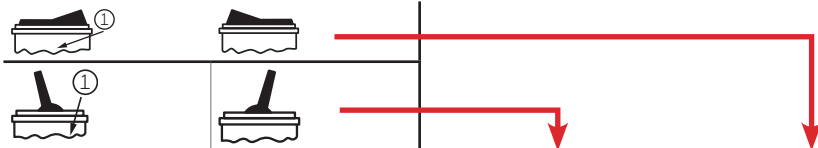
No. of Poles	Contact Material	Circuits Left Position	Circuits Center Position	Circuits Right Position	Paddle Switch Cat. Listings	Rocker Switch Cat. Listings
1PDT	Silver	1-2	OFF	2-3	AML23EBA2AA04	AML24EBA2AA04
	Gold	1-2	OFF	2-3	-	AML24EBA2BA04
	Silver	1-2 Mom.	OFF	2-3 Mom.	AML23EBA2AA05	AML24EBA2AA05
	Gold	1-2 Mom.	OFF	2-3 Mom.	-	AML24EBA2BA05
	Silver	1-2	OFF	2-3 Mom.	-	AML24EBA2AA06
2PDT	Silver	1-2, 4-5	OFF	2-3, 5-6	AML23EBA2AC04	AML24EBA2AC04
	Gold	1-2, 4-5	OFF	2-3, 5-6	AML23EBA2BC04	AML24EBA2BC04
	Silver	1-2, 4-5 Mom.	OFF	2-3, 5-6 Mom.	-	AML24EBA2AC05
	Silver	1-2, 4-5	OFF	2-3, 5-6 Mom.	-	AML24EBA2AC06
	Gold	1-2, 4-5	OFF	2-3, 5-6 Mom.	AML23EBA2BC06	
	Silver	1-2, 4-5 Mom.	OFF	2-3, 5-6	-	AML24EBA2AC07
	Silver	1-2, 4-5	2-3, 4-5	2-3, 5-6	-	AML24EBA2CA04
	Gold	1-2, 4-5	2-3, 4-5	2-3, 5-6	-	AML24EBA2DA04
	Silver	1-2, 4-5 Mom.	2-3, 4-5	2-3, 5-6 Mom.	AML23EBA2CA05*	AML24EBA2CA05*
	Silver	1-2, 4-5	2-3, 4-5	2-3, 5-6 Mom.	-	AML24EBA2CA06*
4PDT	Silver	1-2, 4-5, 7-8, 10-11	2-3, 4, 5, 8-9, 10-11	2-3, 5-6, 8-9, 11-12	-	AML24EBA2CC04
	Gold	1-2, 4-5, 7-8, 10-11	2-3, 4, 5, 8-9, 10-11	2-3, 5-6, 8-9, 11-12	-	AML24EBA2DC04
	Silver	1-2, 4-5, 7-8, 10-11 Mom.	2-3, 4, 5, 8-9, 10-11	2-3, 5-6, 8-9, 11-12 Mom.	-	AML24EBA2CC05

① MICRO SWITCH identification on this side of switch housing

Note: All switch positions are maintained except where noted as Mom. (momentary)

\*These two pole switches have the six switch terminals in line on rear of housing

**Table 20. Power-duty Unlighted (2 Position) AML33 Series Paddle and AML34 Series Rocker Switches<sup>1</sup> (Maintained)**



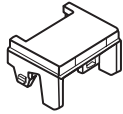
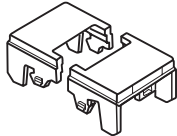
No. of Poles	Contact Material	Circuits Left Position	Circuits Right Position	Paddle Switch Cat. Listings	Rocker Switch Cat. Listings
1PST normally open(Form A)	Silver	11-12	OFF	AML33EBA4AA01	AML34EBA4AA01
2PST normally open(Form A)	Silver	11-12, 21-22	OFF	AML33EBA4AC01	AML34EBA4AC01

Note: AML33 Series Paddle switches require AML53-E Series Cover (2 required) or AML53-T Series Cover from table 21

Note: AML34 Series Rocker switches require AML54-F Series Button (full rocker button) or AML54-T Series Button (2 piece rocker button) from table 22

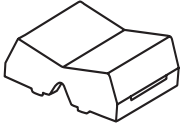

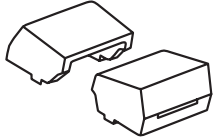
<sup>1</sup>All "power-duty" pushbutton, paddle, and rocker switches (AML30 Series) have 0.187 in x 0.020 in termination

**Table 21. AML53 Series Paddle Switch Covers without Legends for AML23 & AML33 Series Paddle Switches\*\***

Cover Color	AML53-E Series (1/2 Cover) (Two Required)	AML53-T Series (Two-Piece Cover)
		
Red	AML53-E10R	AML53-T10RR
Yellow	AML53-E10Y	AML53-T10YY
Green	AML53-E10G	AML53-T10GG
Blue	AML53-E10B	-
White	AML53-E10W	AML53-T10WW
Black	AML53-E10K	AML53-T10KK
Red/Green	-	AML53-T10RG
Green/Red	-	AML53-T10GR

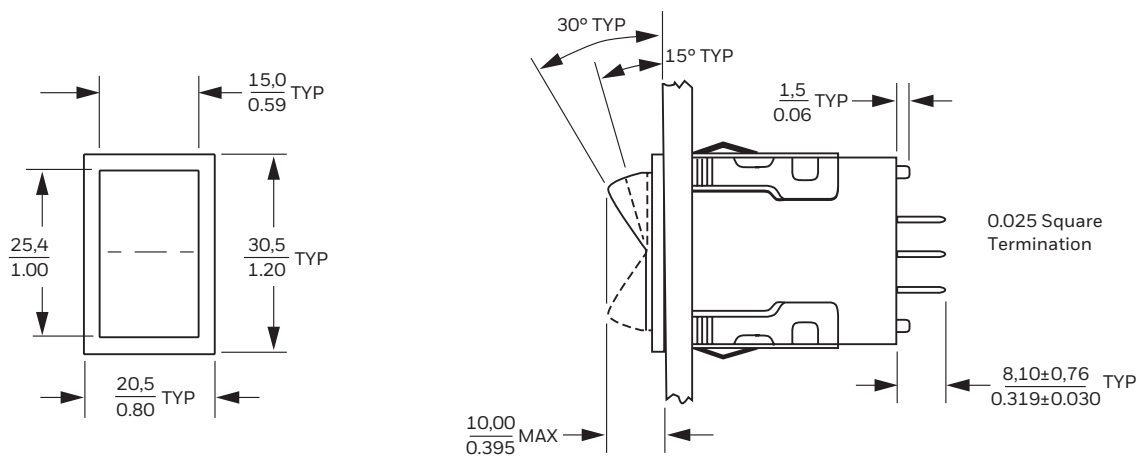
\*\*For AML53 Series Paddle Switch Covers Style E or T from table above with Legends contact the local Honeywell source

**Table 22. AML54 Series Rocker Switch Buttons without Legends for AML24 & AML34 Series Rocker Switches\*\*\***

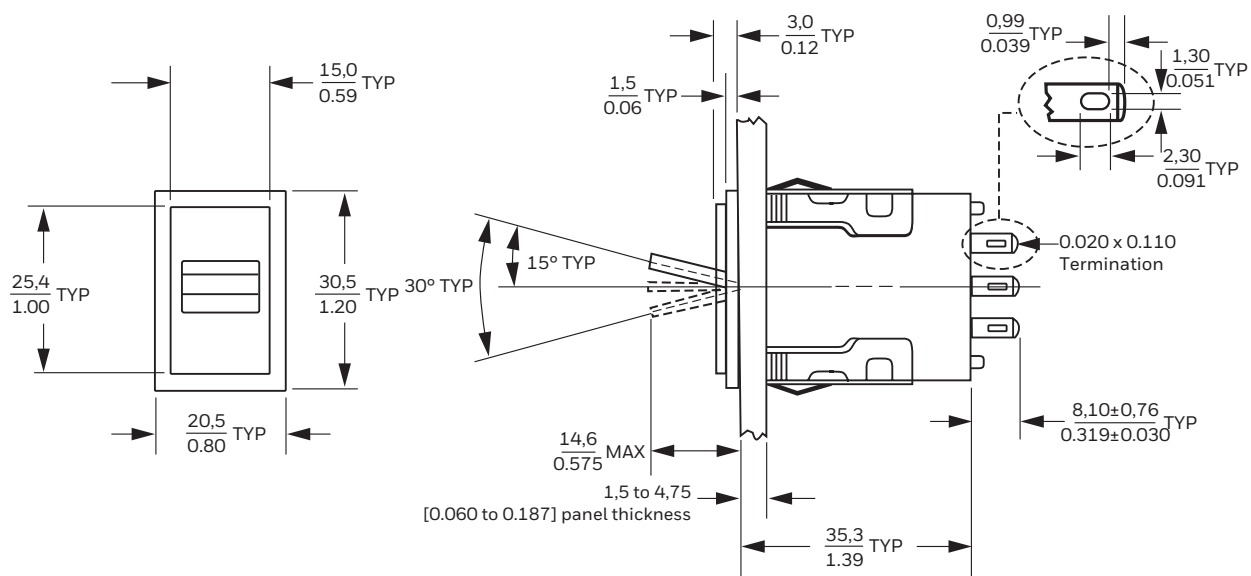
Cover Color	AML54-F Series (Full Rocker Button)	AML54-E Series (1/2 Rocker Button, 2 Required)	AML54-T Series (Two-Piece Button)
			
Red	AML54-F10R	AML54-E10R	AML54-T10RR
Yellow	AML54-F10Y	-	-
Green	AML54-F10G	AML54-E10G	AML54-T10GG
Blue	AML54-F10B	-	AML54-T10BB
White	AML54-F10W	AML54-E10W	-
Amber	AML54-F10A	-	-
Black	AML54-F10K	AML54-E10K	AML54-T10KK
Gray	AML54-F10L	-	AML54-T10LL
Red/Yellow	-	-	AML54-T10RY
Red/Green	-	-	AML54-T10RG
Green/Red	-	-	AML54-T10GR
Green/Yellow	-	-	AML54-T10GY
Blue/White	-	-	AML54-T10BW

\*\*\*For AML54 Series Rocker Switch Operator Style E, F, or T from table above with Legends contact the local Honeywell source

Figure 15. AML23 and AML24 Series Dimensions, mm [in] or mm/in

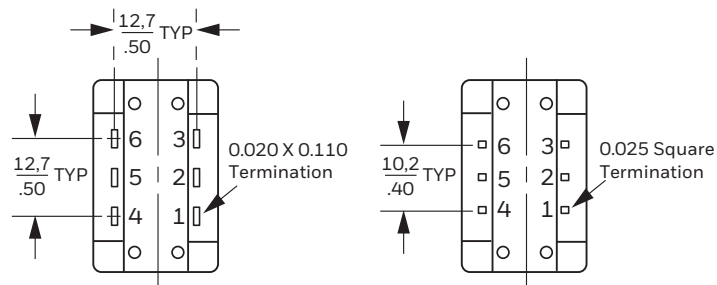


Rocker



Paddle

ONE AND TWO POLE



FOUR POLE

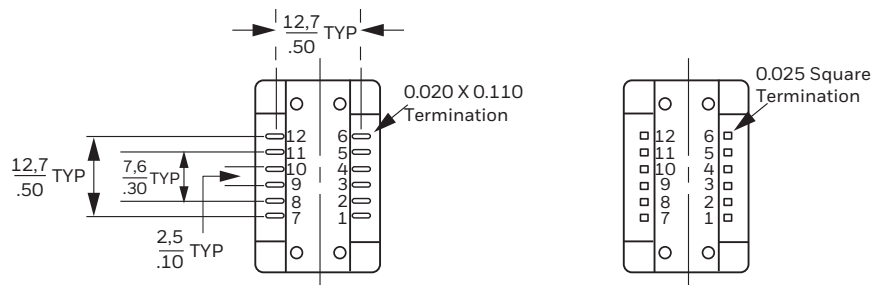
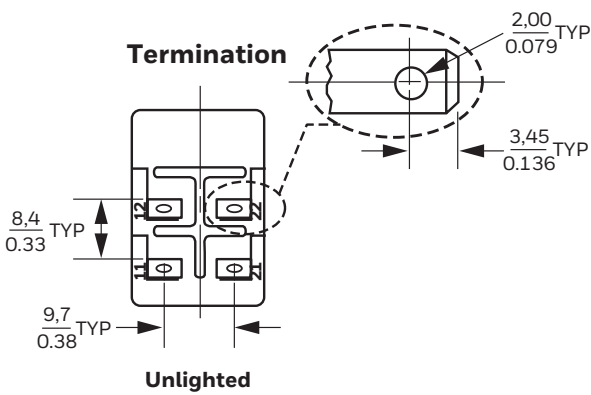
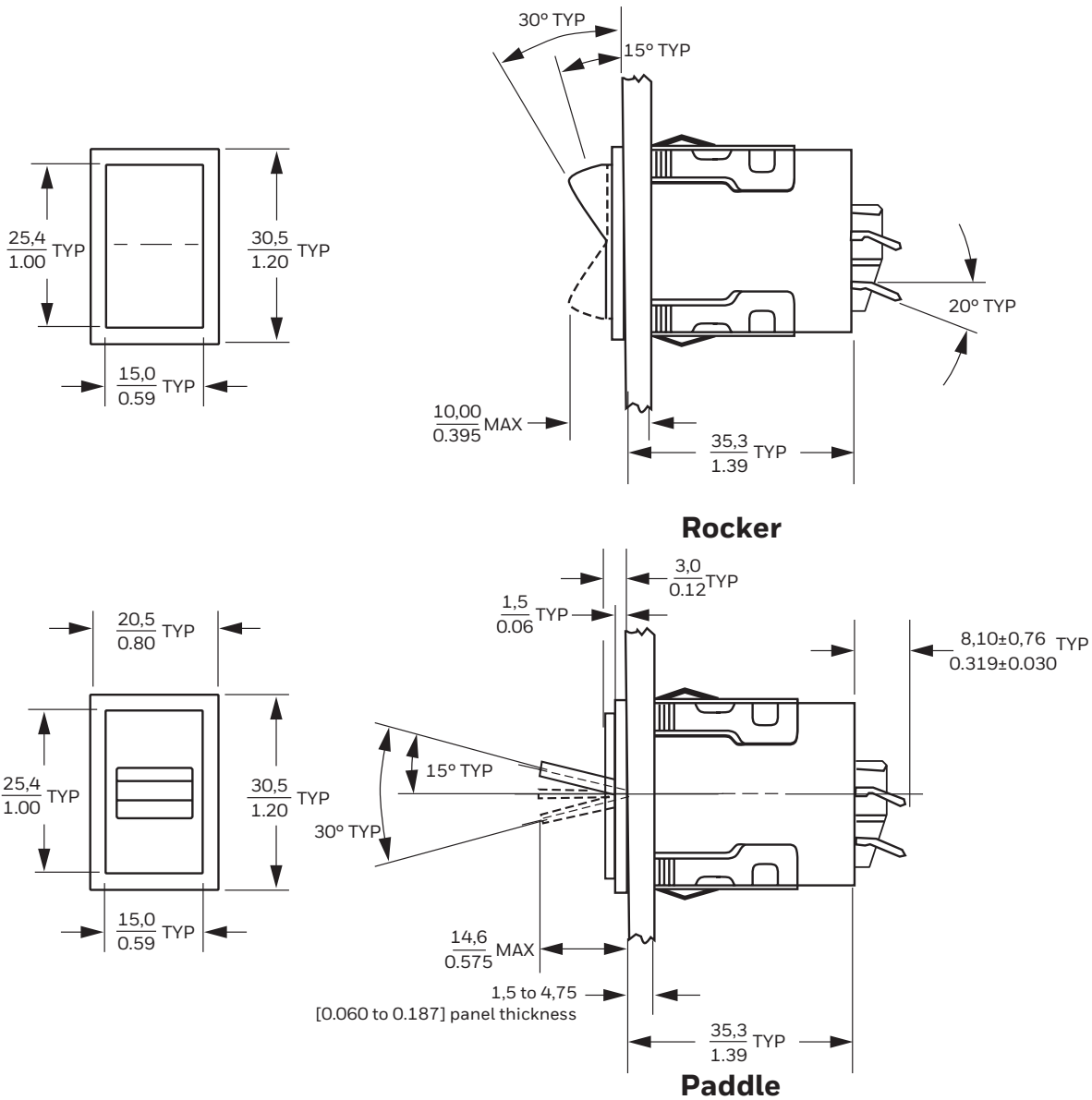


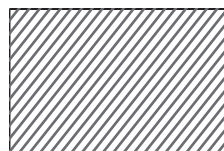


Figure 16. AML33 and AML34 Series Dimensions, mm[in] or mm/in

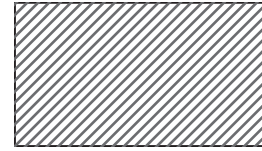


**Panel Cutouts for AML20 and AML30 Series Paddles and Rockers**

**WITHOUT BARRIERS**      **WITH SHORT BARRIERS<sup>1</sup>**

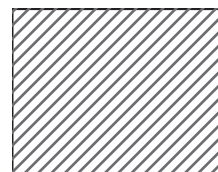


28,98 [1.141] x 19,05 [0.750]



33,27 [1.310] x 19,05 [0.750]

**WITH LONG BARRIERS<sup>1</sup>**



28,98 [1.141] x 23,25 [0.915]

<sup>1</sup> Table 47 describes barrier options. Barriers are designed to prevent inadvertent actuation of adjacent-mounted switches.

**AML23E**

Housing Type: Paddle

**AML23E** Unlighted

**B**

Bezel Color

**B** Black

**A**

Incandescent Lamp Type

**A** No lamp circuit

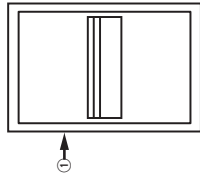
**2**

Terminal Type

**2** 2.8 mm x 0.5 mm [0.110 in x 0.020 in] quick-connect or solder

NOTE: Not all combinations of model codes are available. Please contact your Honeywell provider/representative for assistance.

<sup>2</sup>Reference Table 18 or 19.



① The "MICRO SWITCH" identification is shown on this side of the switch housings

**AA**

Number of Poles and Contact Material

<b>AA</b>	SILVER CONTACTS	<b>BA</b>	One SPDT
<b>AC</b>	GOLD CONTACTS	<b>BC</b>	Two SPDT (unlighted switches only)
<b>CA</b>		<b>DA</b>	Two SPDT
<b>CC</b>		<b>DC</b>	Four SPDT (unlighted switches only)

**01**

Operator Positions and Action<sup>2</sup>

<b>01</b>	Left: maintained Right: maintained
<b>02</b>	Left: momentary Right: maintained
<b>03</b>	Left: maintained Right: momentary
<b>04</b>	Left: maintained Center: maintained Right: maintained
<b>05</b>	Left: momentary Center: maintained Right: momentary
<b>06</b>	Left: maintained Center: maintained Right: momentary
<b>07</b>	Left: momentary Center: maintained Right: maintained

Figure 17. AML23 Series Unlighted Paddle Switches Nomenclature

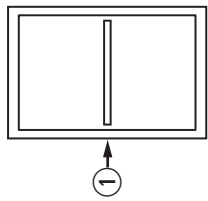
**Figure 18. AML24 Unlighted Rocker Switches Series Nomenclature**

<b>AML24E</b>	<b>A</b>	<b>B</b>	<b>2</b>	<b>AA</b>	<b>01</b>
Housing Type: Rocker	Incandescent Lamp Type	Bezel Color	Terminal Type	Number of Poles and Contact Material	Operator Positions and Action <sup>2</sup>
<b>AML24E</b> Unlighted	<b>A</b> No lamp circuit	<b>B</b> Black	<b>2</b> 2.8 mm x 0.5 mm [0.110 in x 0.020 in] quick-connect or solder	<b>AA</b> SILVER CONTACTS <b>BA</b> GOLD CONTACTS One SPDT	<b>01</b> Left: maintained Right: maintained
			<b>3</b> 0.64 mm x 0.64 mm [0.025 in x 0.025 in] push-on or printed circuit	<b>AC</b> Two SPDT (unlighted switches only)	<b>02</b> Left: momentary Right: maintained
				<b>CA</b> Two SPDT	<b>03</b> Left: maintained Right: momentary
				<b>CC</b> Four SPDT (unlighted switches only)	<b>04</b> Left: maintained Center: maintained Right: maintained
					<b>05</b> Left: momentary Center: maintained Right: momentary
					<b>06</b> Left: maintained Center: maintained Right: momentary
					<b>07</b> Left: momentary Center: maintained Right: maintained

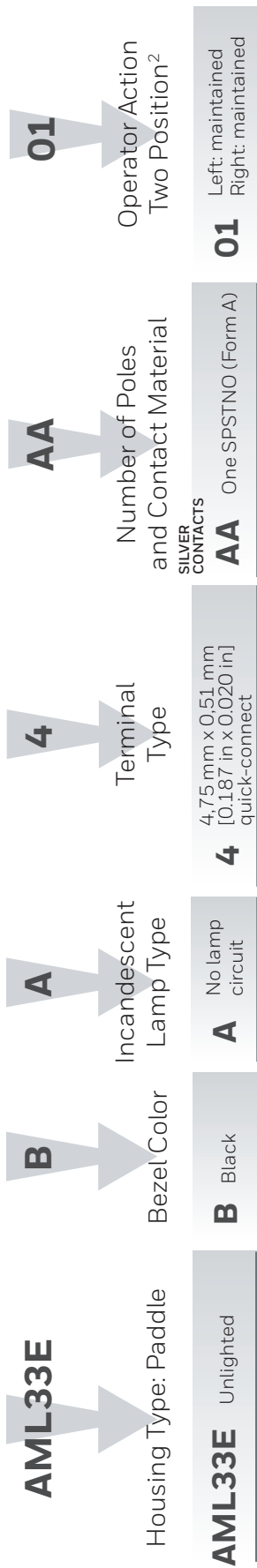
NOTE: Not all combinations of model codes are available. Please contact your Honeywell provider/representative for assistance.

<sup>2</sup>Reference Table 18 or 19.



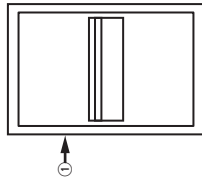
① The "MICRO SWITCH" identification is shown on this side of the switch housings

Figure 19. AML33 Unlighted Paddle Switch Series Nomenclature



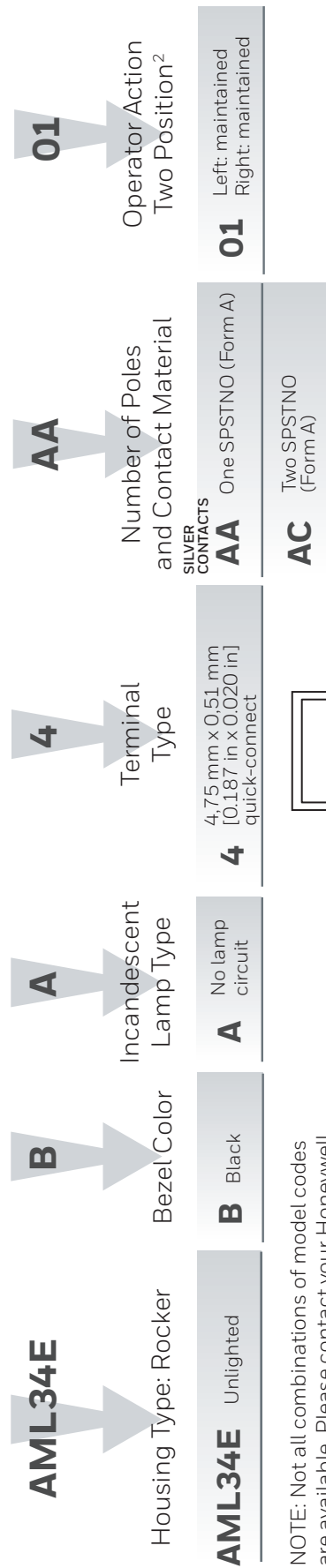
NOTE: Not all combinations of model codes are available. Please contact your Honeywell provider/representative for assistance.

<sup>2</sup>Reference Table 20.



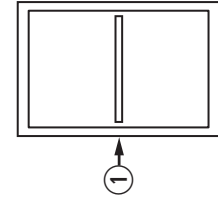
① The "MICRO SWITCH" identification is shown on this side of the switch housings

Figure 20. AML34 Series Nomenclature



NOTE: Not all combinations of model codes are available. Please contact your Honeywell provider/representative for assistance.

<sup>2</sup>Reference Table 20.



① The "MICRO SWITCH" identification is shown on this side of the switch housings

**Figure 21. AML53 Covers for AML23 and AML33 Series Paddle Switches Nomenclature**  
For incandescent lighted and unlighted paddle switches

<b>AML53-E</b>		<b>10</b>	<b>W</b>	
<b>AML53-T</b>		<b>11</b>	<b>R</b>	<b>G</b>
Paddle-Style Cover		Display Type	1/2 cover or 1-side of 2-piece cover	Req'd if ordering two-piece cover
<b>AML53-E</b>	1/2 cover (two required per switch)	<b>10</b>	<b>R</b>	<b>R</b>
<b>AML53-T</b>	Two-piece cover	<b>11</b>	<b>Y</b>	<b>Y</b>
		<b>30</b>	<b>G</b>	<b>G</b>
		<b>50</b>	<b>B</b>	<b>B</b>
			<b>W</b>	<b>W</b>
			<b>K</b>	<b>K</b>
			<b>L</b>	<b>L</b>
			<b>A</b>	<b>A</b>

NOTE: Not all combinations of model codes are available. Please contact your Honeywell provider/representative for assistance  
\*Insert is clear when display type (50) is specified with white (W) color  
\*\*Available with display type "transmitted color" and "dead front" only

**Figure 22. AML54 Buttons for AML24 and AML34 Series Rocker Switches Nomenclature**  
For incandescent lighted and unlighted paddle switches

<b>AML54-T</b>		<b>11</b>	<b>R</b>	<b>G</b>
Rocker Style Button		Display Type	Full Rocker, 1/2 Rocker or 1-side of 2-piece Rocker	Req'd if ordering Two-Piece Rocker
<b>AML54-F</b>	Full rocker	<b>10</b>	<b>R</b>	<b>R</b>
<b>AML54-E</b>	1/2 rocker (two required per switch)	<b>11</b>	<b>Y</b>	<b>Y</b>
<b>AML54-T</b>	Two-piece rocker	<b>30</b>	<b>G</b>	<b>G</b>
		<b>50</b>	<b>B</b>	<b>B</b>
			<b>W</b>	<b>W</b>
			<b>K</b>	<b>K</b>
			<b>L</b>	<b>L</b>
			<b>A</b>	<b>A</b>

NOTE: Not all combinations of model codes are available. Please contact your Honeywell provider/representative for assistance  
\*Insert is clear when display type (50) is specified with white (W) color  
\*\*Available with display type "transmitted color" and "dead front" only

**Operator with Integral Contact Block**  
(see Tables 23 & 24)

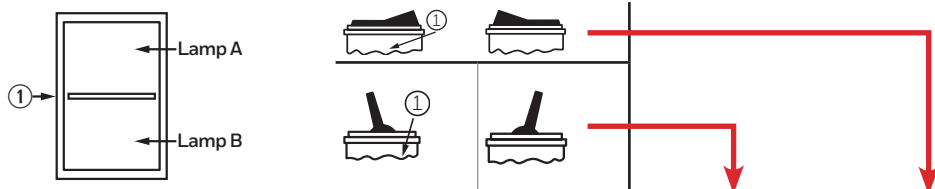
**Button**  
(see Tables 25 & 26)

**Complete Unit**

- Catalog Listing with 0.110 x 0.020 quick connect or solder terminals



**Table 23. Incandescent Lighted AML23 Series Paddle and AML24 Series Rocker Switches Catalog Listings (2 Position)**

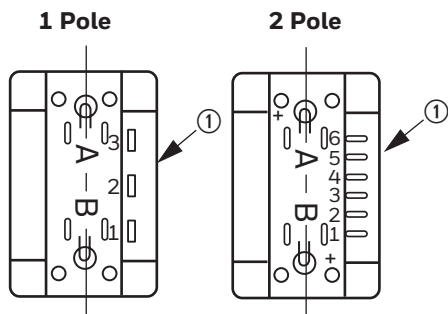


No. of Poles	Contact Material	Lamp "A"	Lamp "B"	Circuits Left Position	Circuits Right Position	Paddle Switch Cat. Listings	Rocker Switch Cat. Listings	Notes
1	Silver	No lamp provided	No lamp circuit	1-2	2-3	-	AML24FBA2AA01	One Lamp Circuit
1	Silver	14 V lamp (#73)	No lamp circuit	1-2	2-3	-	AML24FBC2AA01	One Lamp Circuit
1	Silver	28 V lamp (#85)	No lamp circuit	1-2	2-3	-	AML24FBE2AA01	One Lamp Circuit
1	Silver	No lamp provided	No lamp provided	1-2	2-3	AML23GBA2AA01	AML24GBA2AA01	Two Lamp Circuits
1	Gold	No lamp provided	No lamp provided	1-2	2-3	-	AML24GBA2BA01	Two Lamp Circuits
1	Silver	No lamp provided	No lamp provided	1-2 Mom.	2-3	-	AML24GBA2AA02	Two Lamp Circuits
1	Silver	28 V lamp (#85)	28 V lamp (#85)	1-2	2-3	AML23GBE2AA01	AML24GBE2AA01	Two Lamp Circuits
1	Gold	28 V lamp (#85)	28 V lamp (#85)	1-2	2-3	-	AML24GBE2BA01	Two Lamp Circuits
1	Silver	28 V lamp (#85)	28 V lamp (#85)	1-2 Mom.	2-3	-	AML24GBE2AA02	Two Lamp Circuits
1	Silver	28 V lamp (#85)	28 V lamp (#85)	1-2	2-3 Mom.	-	AML24GBE2AA03	Two Lamp Circuits
2	Silver	No lamp provided	No lamp circuit	1-2, 4-5	2-3, 5-6	AML23FBACA01	AML24FBA2CA01	One Lamp Circuit
2	Silver	28 V lamp (#85)	No lamp circuit	1-2, 4-5	2-3, 5-6	-	AML24FBE2CA01	One Lamp Circuit
2	Gold	28 V lamp (#85)	No lamp circuit	1-2, 4-5	2-3, 5-6	-	AML24FBE2DA01	One Lamp Circuit
2	Silver	No lamp provided	No lamp provided	1-2, 4-5	2-3, 5-6	-	AML24GBA2CA01	Two Lamp Circuits
2	Silver	No lamp provided	No lamp provided	1-2, 4-5 Mom.	2-3, 5-6	-	AML24GBA2CA02	Two Lamp Circuits
2	Silver	28 V lamp (#85)	28 V lamp (#85)	1-2, 4-5	2-3, 5-6	-	AML24GBE2CA01	Two Lamp Circuits
2	Gold	28 V lamp (#85)	28 V lamp (#85)	1-2, 4-5	2-3, 5-6	-	AML24GBE2DA01	Two Lamp Circuits
2	Silver	28 V lamp (#85)	28 V lamp (#85)	1-2, 4-5 Mom.	2-3, 5-6	-	AML24GBE2CA02	Two Lamp Circuits
2	Silver	28 V lamp (#85)	28 V lamp (#85)	1-2, 4-5	2-3, 5-6 Mom.	-	AML24GBE2CA03	Two Lamp Circuits

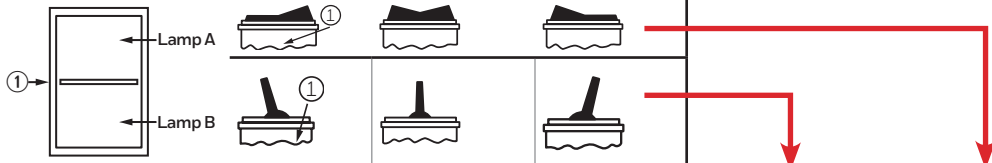
① MICRO SWITCH identification on this side of switch housing

Note: All switch positions are maintained except where noted as Mom. (momentary)

**AML23 and AML24 Terminal Location**



**Table 24. Incandescent Lighted AML23 Series Paddle and AML24 Series Rocker Switches Catalog Listings (3 Position)**

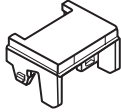
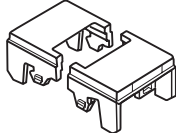


No. of Poles	Contact Material	Lamp "A"	Lamp "B"	Circuits Left Position	Circuits Center Position	Circuits Right Position	Paddle Switch Cat. Listings	Rocker Switch Cat. Listings	Notes
1	Silver	No lamp provided	No lamp circuit	1-2	OFF	2-3	-	AML24FBA2AA04	One Lamp Circuit
1	Silver	No lamp provided	No lamp provided	1-2	OFF	2-3	-	AML24GBA2AA04	Two Lamp Circuits
1	Silver	14 V lamp (#73)	14 V lamp (#73)	1-2	OFF	2-3	-	AML24GBC2AA04	Two Lamp Circuits
1	Silver	28 V lamp (#85)	28 V lamp (#85)	1-2	OFF	2-3	AML23GBE2AA04	AML24GBE2AA04	Two Lamp Circuits
1	Silver	No lamp provided	No lamp circuit	1-2 Mom.	OFF	2-3 Mom.	-	AML24FBA2AA05	One Lamp Circuit
1	Gold	No lamp provided	No lamp circuit	1-2 Mom.	OFF	2-3 Mom.	-	AML24FBA2BA05	One Lamp Circuit
1	Silver	No lamp provided	No lamp provided	1-2 Mom.	OFF	2-3 Mom.	-	AML24GBA2AA05	Two Lamp Circuits
1	Gold	No lamp provided	No lamp provided	1-2 Mom.	OFF	2-3 Mom.	-	AML24GBA2BA05	Two Lamp Circuits
1	Gold	14 V lamp (#73)	14 V lamp (#73)	1-2 Mom.	OFF	2-3 Mom.	-	AML24GBC2BA05	Two Lamp Circuits
1	Silver	28 V lamp (#85)	28 V lamp (#85)	1-2 Mom.	OFF	2-3 Mom.	AML23GBE2AA05	AML24GBE2AA05	Two Lamp Circuits
1	Gold	28 V lamp (#85)	28 V lamp (#85)	1-2 Mom.	OFF	2-3 Mom.	-	AML24GBE2BA05	Two Lamp Circuits
1	Silver	28 V lamp (#85)	28 V lamp (#85)	1-2	OFF	2-3 Mom.	AML23GBE2AA06	-	Two Lamp Circuits
1	Silver	No lamp provided	No lamp provided	1-2 Mom.	OFF	2-3	-	AML24GBA2AA07	Two Lamp Circuits
2	Silver	No lamp provided	No lamp provided	1-2, 4-5	2-3, 4-5	2-3, 5-6	AML23GBA2CA04	AML24GBA2CA04	Two Lamp Circuits
2	Silver	28 V lamp (#85)	28 V lamp (#85)	1-2, 4-5	2-3, 4-5	2-3, 5-6	AML23GBE2CA04	AML24GBE2CA04	Two Lamp Circuits
2	Silver	No lamp provided	No lamp circuit	1-2, 4-5 Mom.	2-3, 4-5	2-3, 5-6 Mom.	-	AML24FBA2CA05	One Lamp Circuit
2	Silver	28 V lamp (#85)	No lamp circuit	1-2, 4-5 Mom.	2-3, 4-5	2-3, 5-6 Mom.	-	AML24FBE2CA05	One Lamp Circuit
2	Silver	No lamp provided	No lamp provided	1-2, 4-5 Mom.	2-3, 4-5	2-3, 5-6 Mom.	AML23GBA2CA05	AML24GBA2CA05	Two Lamp Circuits
2	Silver	14 V lamp (#73)	14 V lamp (#73)	1-2, 4-5 Mom.	2-3, 4-5	2-3, 5-6 Mom.	-	AML24GBC2CA05	Two Lamp Circuits
2	Silver	28 V lamp (#85)	28 V lamp (#85)	1-2, 4-5 Mom.	2-3, 4-5	2-3, 5-6 Mom.	-	AML24GBE2CA05	Two Lamp Circuits
2	Gold	No lamp provided	No lamp provided	1-2, 4-5 Mom.	2-3, 4-5	2-3, 5-6 Mom.	-	AML24GBA2DA05	Two Lamp Circuits
2	Gold	28 V lamp (#85)	28 V lamp (#85)	1-2, 4-5 Mom.	2-3, 4-5	2-3, 5-6 Mom.	-	AML24GBE2DA05	Two Lamp Circuits
2	Silver	No lamp provided	No lamp provided	1-2, 4-5	2-3, 4-5	2-3, 5-6 Mom.	AML23GBA2CA06	-	Two Lamp Circuits
2	Silver	No lamp provided	No lamp provided	1-2, 4-5 Mom.	2-3, 4-5	2-3, 5-6	-	AML24GBA2CA07	Two Lamp Circuits

① MICRO SWITCH identification on this side of switch housing



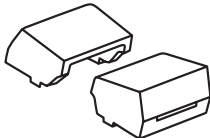
Note: All switch positions are maintained except where noted as Mom. (momentary)

**Table 25. AML53 Series Paddle Switch Covers without Legend for AML23 & AML33 Series Lighted Paddle Switches\***

Cover Color	AML53-E Series (1/2 Cover)	AML53-T Series (Two piece Cover)
		
Red	AML53-E10R	AML53-T10RR
Yellow	AML53-E10Y	AML53-T10YY
Green	AML53-E10G	AML53-T10GG
Blue	AML53-E10B	-
White	AML53-E10W	AML53-T10WW
Red/Green	-	AML53-T10RG
Green/Red	-	AML53-T10GR

\*For AML53 Series Paddle Switch Covers Style E or T from table above with Legends contact the local Honeywell source

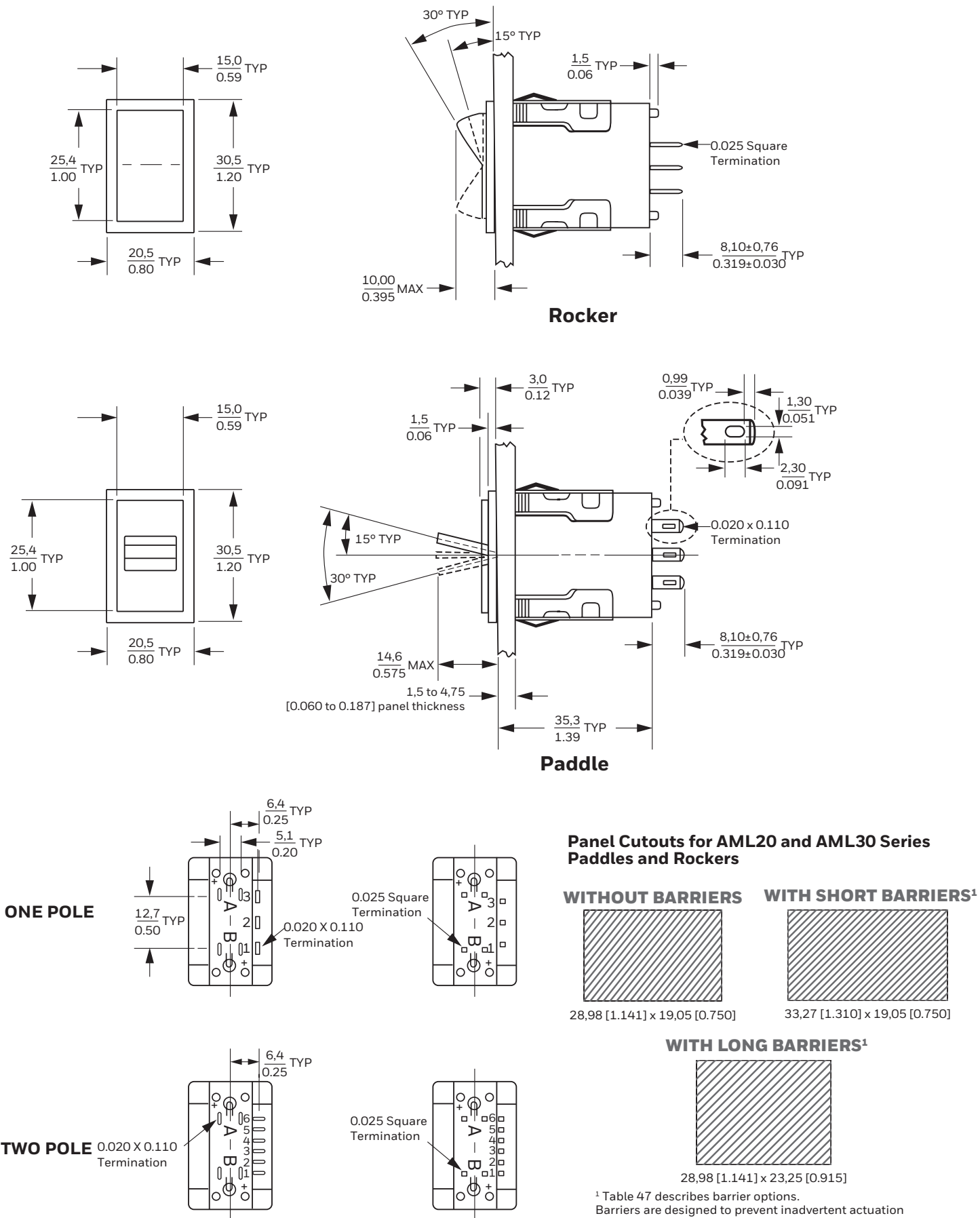
**Table 26. AML54 Series Rocker Switch Buttons without Legends for AML24 & AML34 Series Lighted Rocker Switches\*\***

Cover Color	AML54-F Series (Full Rocker Button)	AML54-E Series (1/2 Rocker Button, 2 required)	AML54-T Series (Two-piece Button)
			
Red	AML54-F10R	AML54-E10R	AML54-T10RR
Yellow	AML54-F10Y	-	-
Green	AML54-F10G	AML54-E10G	AML54-T10GG
Blue	AML54-F10B	-	AML54-T10BB
White	AML54-F10W	AML54-E10W	-
Amber	AML54-F10A	-	-
Black	-	AML54-E10K	-
Red/Yellow	-	-	AML54-T10RY
Red/Green	-	-	AML54-T10RG
Green/Red	-	-	AML54-T10GR
Green/Yellow	-	-	AML54-T10GY
Blue/White	-	-	AML54-T10BW

\*\*For AML54 Series Rocker Switch Covers Style F, E or T from table above with Legends contact the local Honeywell source



Figure 23. AML23 and AML24 Series Dimensions mm [in] or mm\in



**AML23F**

Housing Type: Paddle

<b>AML23F</b>	1 lamp circuit (A)
<b>AML23G</b>	2 lamp circuits (A & B)

**B**

Bezel Color

<b>B</b>	Black
----------	-------

**B**

Incandescent Lamp Type

<b>A</b>	No lamp provided
<b>B</b>	6 V lamp (#86)
<b>C</b>	14 V lamp (#77)
<b>E</b>	28 V lamp (#85)

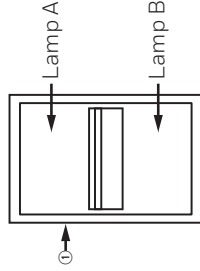
**2**

Terminal Type

<b>2</b>	2.8 mm x 0.5 mm [0.110 in x 0.020 in] quick connector or solder
<b>3</b>	0.64 mm x 0.64 mm [0.025 in x 0.025 in] push-on or printed circuit

NOTE: Not all combinations of model codes are available. Please contact your Honeywell provider/representative for assistance.

<sup>2</sup>Reference Table 23 and 24.



② The "MICRO SWITCH" identification is shown on this side of the switch housings

**AA**

Number of Poles and Contact Material

<b>AA</b>	SILVER CONTACTS	<b>BA</b>	GOLD CONTACTS
<b>CA</b>	One SPDT	<b>DA</b>	Two SPDT

**01**

Operator Position and Action<sup>2</sup>

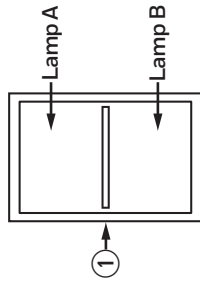
<b>01</b>	Left: maintained Right: maintained	TWO POSITION	
<b>02</b>	Left: momentary Right: maintained		
<b>03</b>	Left: maintained Right: momentary		
<b>04</b>	Left: maintained Center: maintained Right: maintained		THREE POSITION
<b>05</b>	Left: momentary Center: maintained, Right: momentary		
<b>06</b>	Left: maintained Center: maintained, Right: momentary		
<b>07</b>	Left: momentary Center: maintained, Right: maintained		

Figure 25. AML24 Series Nomenclature

AML24F	Housing Type: Rocker	Bezel Color	Incandescent Lamp Type	Terminal Type	Number of Poles and Contact Material	Operator Position and Action <sup>2</sup>
<b>AML24F</b>	1 lamp circuit (A)	<b>B</b> Black	<b>A</b> No lamp provided	<b>2</b> 2.8 mm x 0.5 mm [0.110 in x 0.020 in] quick-connect or solder	<b>AA</b> SILVER CONTACTS <b>BA</b> GOLD CONTACTS <b>CA</b> One SPDT <b>DA</b> Two SPDT	<b>01</b> Left: maintained Right: maintained
<b>AML24G</b>	2 lamp circuits (A & B)		<b>B</b> 6 V lamp (#86)	<b>3</b> 0.64 mm x 0.64 mm [0.025 in x 0.025 in] push-on or printed circuit		<b>02</b> Left: momentary Right: maintained
			<b>C</b> 14 V lamp (#77)			<b>03</b> Left: maintained Right: momentary
			<b>E</b> 28 V lamp (#85)			<b>04</b> Left: maintained Center: maintained Right: maintained
						<b>05</b> Left: momentary Center: maintained, Right: momentary
						<b>06</b> Left: maintained Center: maintained, Right: momentary
						<b>07</b> Left: momentary Center: maintained, Right: maintained

NOTE: Not all combinations of model codes are available. Please contact your Honeywell provider/representative for assistance.

<sup>2</sup>Reference Table 23 and 24.



① The "MICRO SWITCH" identification is shown on this side of the switch housings

**Figure 26. AML53 Covers for AML23 and AML33 Series Paddle Switches Nomenclature**

For incandescent lighted and unlighted paddle switches

<b>AML53-E</b>		<b>10</b>	<b>W</b>	
<b>AML53-T</b>		<b>11</b>	<b>R</b>	<b>G</b>
Paddle Style Cover		Display Type	1/2 Cover or 1-Side of 2-Piece Cover	Req'd if ordering 2-Piece Cover
<b>AML53-E</b>	1/2 cover (two required per switch)	<b>10</b>	<b>R</b> Red	<b>R</b> Red
<b>AML53-T</b>	Two-piece cover	<b>11</b>	<b>Y</b> Yellow	<b>Y</b> Yellow
		<b>30</b>	<b>G</b> Green	<b>G</b> Green
		<b>50</b>	<b>B</b> Blue	<b>B</b> Blue
			<b>W</b> * White	<b>W</b> * White
			<b>K</b> Black	<b>K</b> Black
			<b>L</b> Gray	<b>L</b> Gray
			<b>A</b> ** Amber	<b>A</b> ** Amber

NOTE: Not all combinations of model codes are available. Please contact your Honeywell provider/representative for assistance  
 \*Insert is clear when display type (50) is specified with white(W) color  
 \*\*Available with display type "transmitted color" and "dead front" only

**Figure 27. AML54 Buttons for AML24 and AML34 Series Rocker Switches Nomenclature**

For incandescent lighted and unlighted rocker switches

<b>AML54-T</b>		<b>11</b>	<b>R</b>	<b>G</b>
Rocker Style Button		Display Type	Full Rocker, 1/2 Rocker or 1-side of 2-piece Rocker	Req'd if ordering two-piece rocker
<b>AML54-F</b>	Full rocker	<b>10</b>	<b>R</b> Red	<b>R</b> Red
<b>AML54-E</b>	1/2 rocker (two required per switch)	<b>11</b>	<b>Y</b> Yellow	<b>Y</b> Yellow
<b>AML54-T</b>	Two-piece rocker	<b>30</b>	<b>G</b> Green	<b>G</b> Green
		<b>50</b>	<b>B</b> Blue	<b>B</b> Blue
			<b>W</b> * White	<b>W</b> * White
			<b>K</b> Black	<b>K</b> Black
			<b>L</b> Gray	<b>L</b> Gray
			<b>A</b> ** Amber	<b>A</b> ** Amber

NOTE: Not all combinations of model codes are available. Please contact your Honeywell provider/representative for assistance  
 \*Insert is clear when display type (50) is specified with white(W) color  
 \*\*Available with display type "transmitted color" and "dead front" only

**Operator with Integral Contact Block**  
(see Table 27)



**Button**  
(see Table 28)

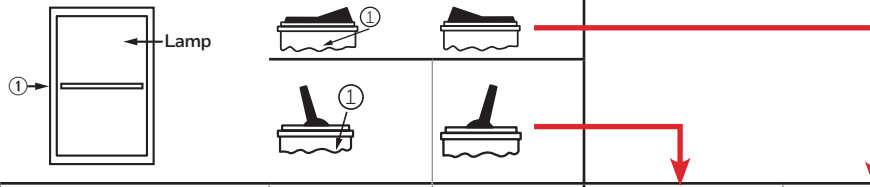


**Complete Unit**



- Catalog Listing with 0.187 x 0.020 quick connect or solder terminals
- Maintained two position

**Table 27. Incandescent Lighted AML33 Series Paddle and AML34 Series Rocker Power-duty Lighted Switches Catalog Listings**



No. of Poles	Contact Material	Replaceable Incandescent Lamp Type (T-1 3/4 wedge base)	Circuits Left Position	Circuits Right Position	Paddle Switch Cat. Listings	Rocker Switch Cat. Listings	Notes
1PST normally open (Form A)	Silver	No lamp provided	11 - 12	OFF	-	AML34FBA4AA01	One Lamp Circuit
2PST normally open (Form A)	Silver	No lamp provided	11 - 12, 21 - 22	OFF	-	AML34FBA4AC01	One Lamp Circuit

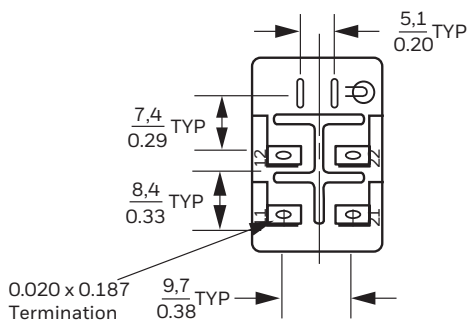
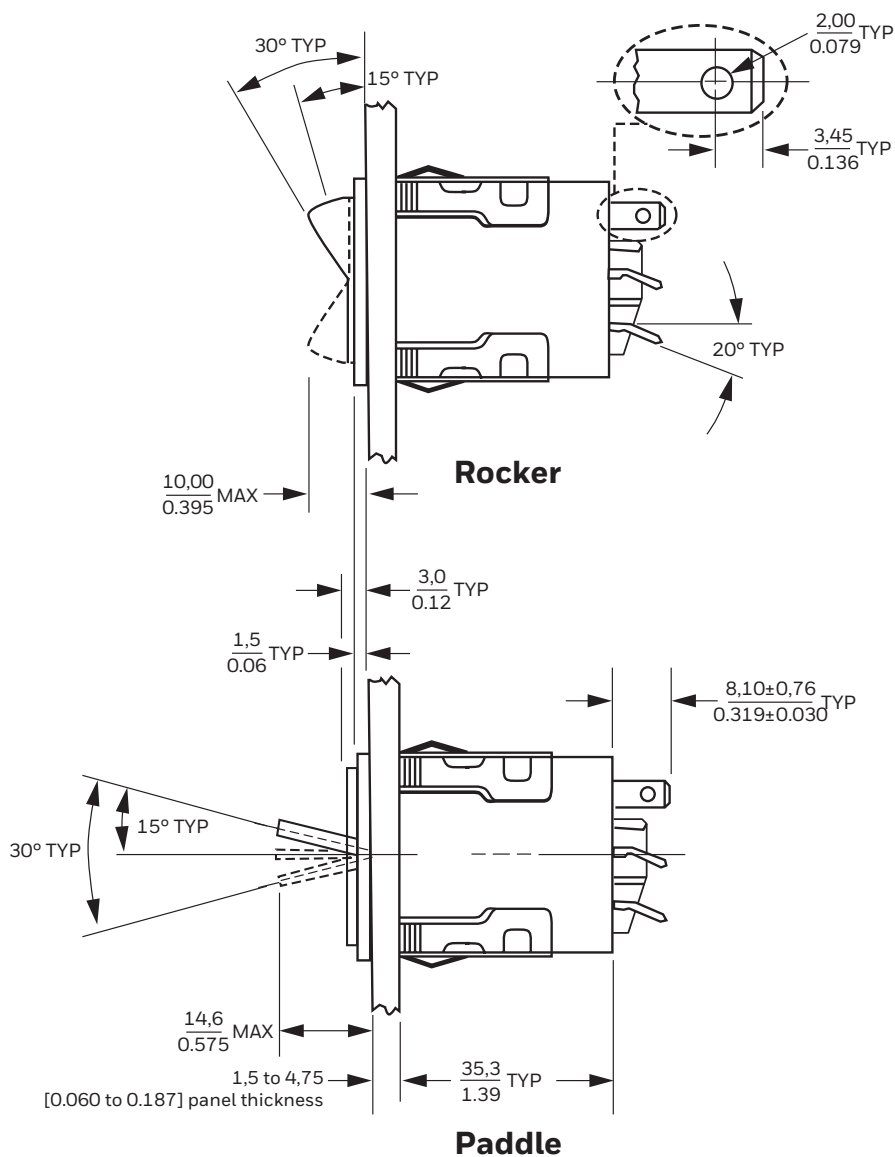
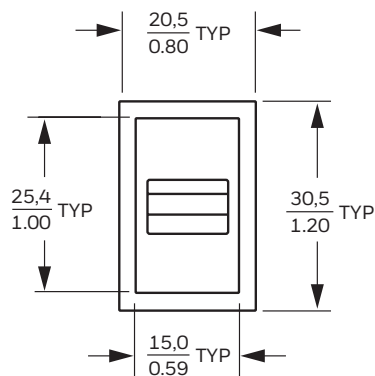
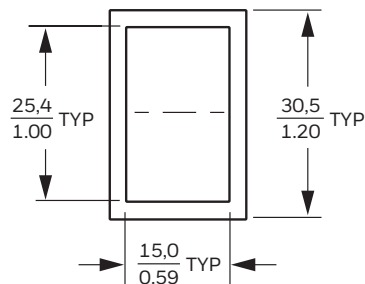
① MICRO SWITCH identification on this side of switch housing

**Table 28. AML54 Series Rocker Switch Buttons without Legends for AML24 & AML34 Series Lighted Rocker Switches\*\***

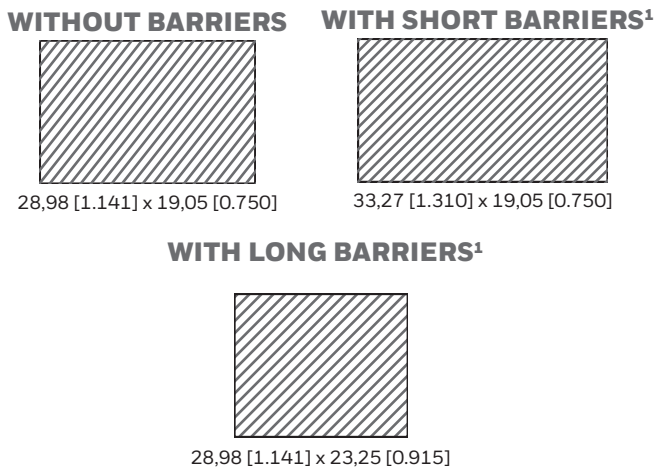
Cover Color	AML54-F Series (Full Rocker Button)	AML54-E Series (1/2 Rocker Button, 2 required)	AML54-T Series (Two-Piece Button)
Red	AML54-F10R	AML54-E10R	AML54-T10RR
Yellow	AML54-F10Y	-	-
Green	AML54-F10G	AML54-E10G	AML54-T10GG
Blue	AML54-F10B	-	AML54-T10BB
White	AML54-F10W	AML54-E10W	-
Amber	AML54-F10A	-	-
Black	-	AML54-E10K	-
Red/Yellow	-	-	AML54-T10RY
Red/Green	-	-	AML54-T10RG
Green/Red	-	-	AML54-T10GR
Green/Yellow	-	-	AML54-T10GY
Blue/White	-	-	AML54-T10BW

\*\*For AML54 Series Rocker Switch Covers Style F, E or T from table above with Legends contact the local Honeywell source

Figure 28. AML33 and AML34 Series Dimensions

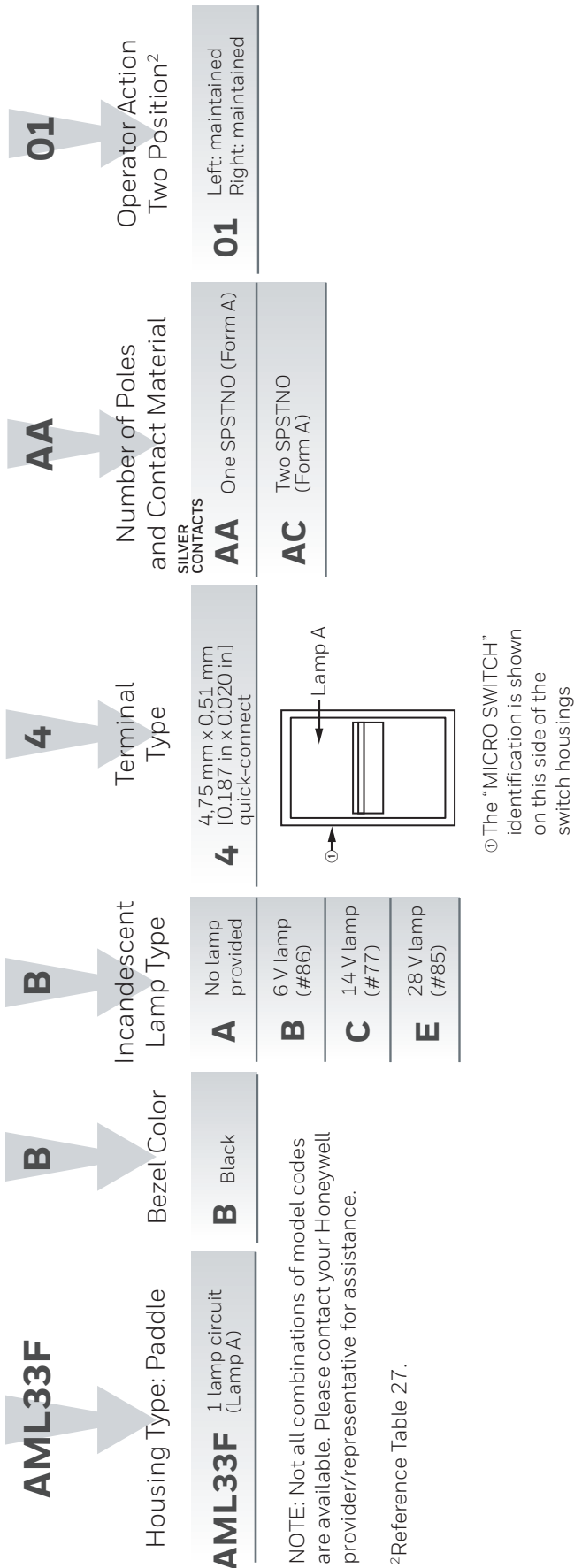


Panel Cutouts for AML20 and AML30 Series Paddles and Rockers



<sup>1</sup> Table 47 describes barrier options. Barriers are designed to prevent inadvertent actuation

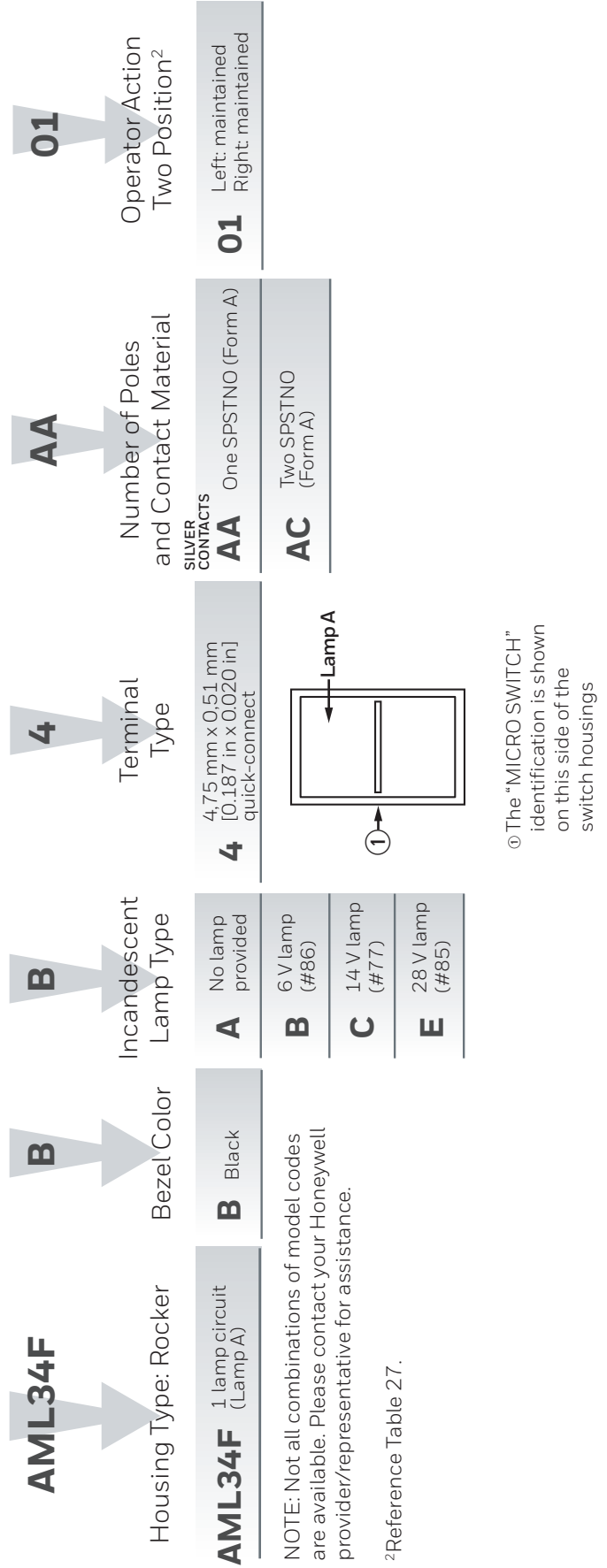
Figure 29. AML37 Series Nomenclature



NOTE: Not all combinations of model codes are available. Please contact your Honeywell provider/representative for assistance.

<sup>2</sup>Reference Table 27.

Figure 30. AML34 Series Nomenclature



NOTE: Not all combinations of model codes are available. Please contact your Honeywell provider/representative for assistance.

<sup>2</sup>Reference Table 27.

**Figure 31. AML53 Covers for AML23 and AML33 Series Paddle Switches Nomenclature**

For incandescent lighted and unlighted paddle switches

<b>AML53-E</b>		<b>10</b>	<b>W</b>	
<b>AML53-T</b>		<b>11</b>	<b>R</b>	<b>G</b>
Paddle Style Cover		Display Type	1/2 cover or 1-side of 2-piece cover	Req'd if ordering two-piece cover
<b>AML53-E</b>	1/2 cover (two required per switch)	<b>10</b>	<b>R</b> Red	<b>R</b> Red
<b>AML53-T</b>	Two-piece cover	<b>11</b>	<b>Y</b> Yellow	<b>Y</b> Yellow
		<b>30</b>	<b>G</b> Green	<b>G</b> Green
		<b>50</b>	<b>B</b> Blue	<b>B</b> Blue
			<b>W</b> * White	<b>W</b> * White
			<b>K</b> Black	<b>K</b> Black
			<b>L</b> Gray	<b>L</b> Gray
			<b>A</b> ** Amber	<b>A</b> ** Amber

NOTE: Not all combinations of model codes are available. Please contact your Honeywell provider/representative for assistance

\*Insert is clear when display type (50) is specified with white (W) color

\*\*Available with display type "transmitted color" and "dead front" only

**Figure 32. AML54 Buttons for AML24 and AML34 Series Rocker Switches Nomenclature**

For incandescent lighted and unlighted rocker switches

<b>AML54-T</b>		<b>11</b>	<b>R</b>	<b>G</b>
<b>AML54-T</b>		<b>11</b>	<b>R</b>	<b>G</b>
Rocker Style Button		Display Type	Full Rocker, 1/2 Rocker or 1-side of 2-piece Rocker	Req'd if ordering 2-piece Rocker
<b>AML54-F</b>	Full rocker	<b>10</b>	<b>R</b> Red	<b>R</b> Red
<b>AML54-E</b>	1/2 rocker (two required per switch)	<b>11</b>	<b>Y</b> Yellow	<b>Y</b> Yellow
<b>AML54-T</b>	Two-piece rocker	<b>30</b>	<b>G</b> Green	<b>G</b> Green
		<b>50</b>	<b>B</b> Blue	<b>B</b> Blue
			<b>W</b> * White	<b>W</b> * White
			<b>K</b> Black	<b>K</b> Black
			<b>L</b> Gray	<b>L</b> Gray
			<b>A</b> ** Amber	<b>A</b> ** Amber

NOTE: Not all combinations of model codes are available. Please contact your Honeywell provider/representative for assistance

\*Insert is clear when display type (50) is specified with white (W) color

\*\*Available with display type "transmitted color" and "dead front" only



**Operator with Integral Contact Block**  
(see Table 29)



**Button**  
(see Tables 30 & 31)

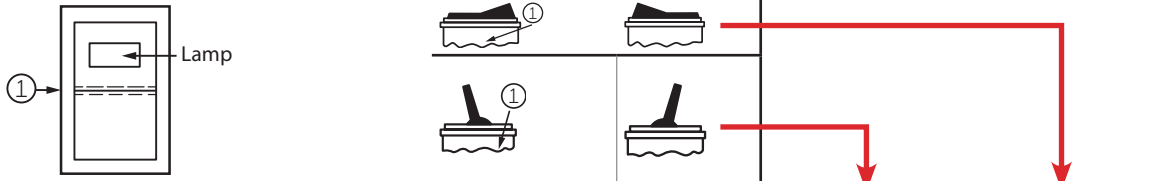


**Complete Unit**



- Catalog Listing with 0.187 x 0.020 quick connect or solder terminals less paddle cover or rocker operator
- Integral neon lamp circuit
- Maintained two positions


**Table 29. AML35 Series Paddle and AML36 Series Rocker Power-duty Lighted Switches with Integral Neon Lamp Catalog Listings**



No. of Poles	Contact Material	Neon Lamp, Voltage, & Color	Neon Lamp Circuit Termination, Independent or Integral	Circuits Left Position	Circuits Right Position	Paddle Switch Cat. Listings	Rocker Switch Cat. Listings
1PST normally open (Form A)	Silver	125 Vac, Red	Independent	11 - 12	OFF	AML35FBB4AA01	AML36FBA4AA01
1PST normally open (Form A)	Silver	250 Vac, Red	Independent	11 - 12	OFF	-	AML36FBC4AA01
2PST normally open (Form A)	Silver	125 Vac, Red	Independent	11 - 12, 21 - 22	OFF	-	AML36FBB4AC01
2PST normally open (Form A)	Silver	125 Vac, Red	Integral	11 - 12, 21 - 22	OFF	AML35FBB7AC01	AML36FBB7AC01
2PST normally open (Form A)	Silver	250 Vac, Red	Integral	11 - 12, 21 - 22	OFF	-	AML36FBC7AC01
2PST normally open (Form A)	Silver	250 Vac, Green	Integral	11 - 12, 21 - 22	OFF	-	AML36FBP7AC01

① MICRO SWITCH identification on this side of switch housing

**Table 30. AML55 Series Paddle Switch Covers without Legend for AML35 Series Neon Lighted Paddle Switches**

Lens Color	Cover Color	AML55-N Series Full Cover with Lens
		
Red	Red	AML55-N10RR
Red	Black	AML55-N10RK

**Table 31. AML56 Series Rocker Switch Button without Legend for AML36 Series Neon Lighted Rocker Switches**


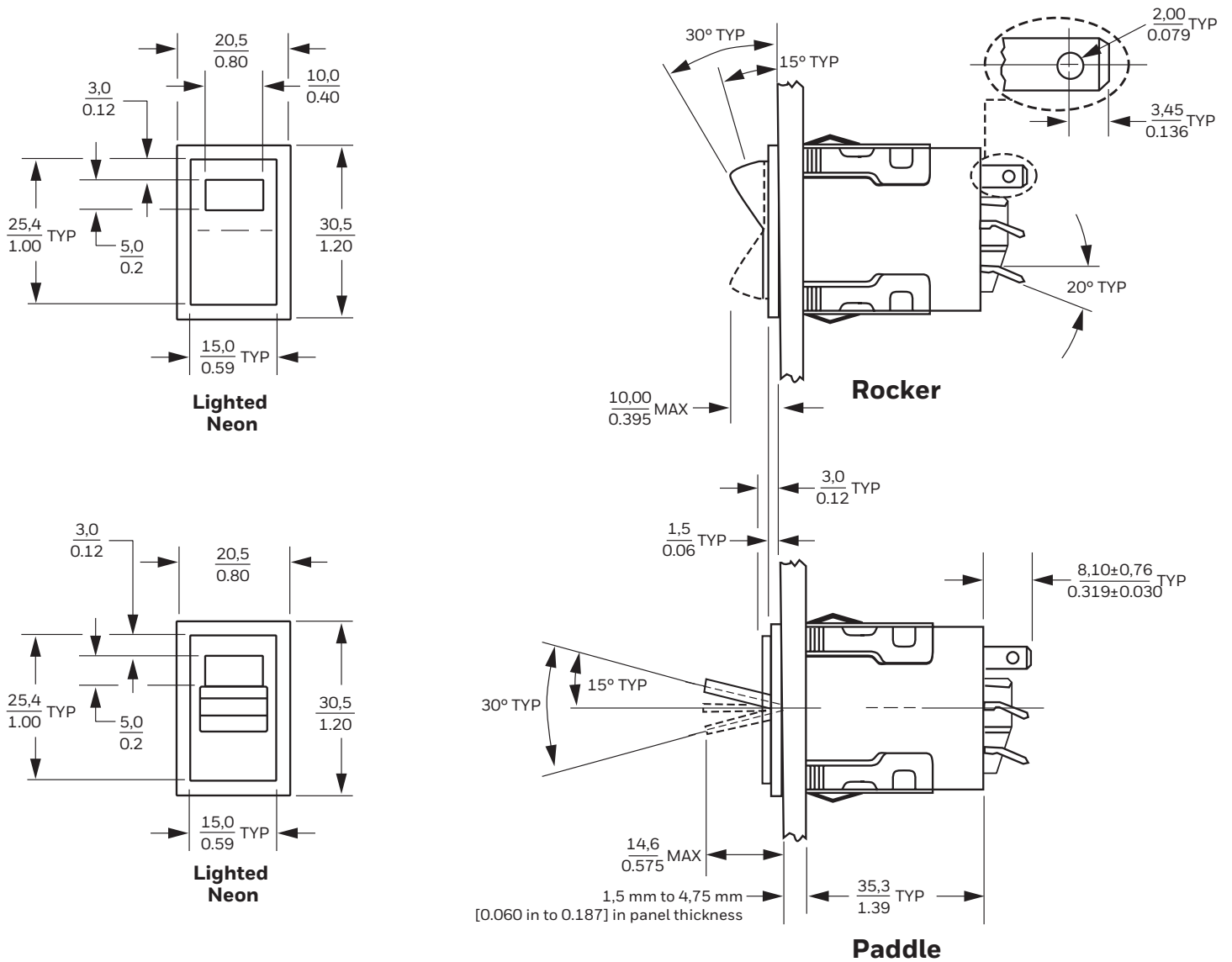
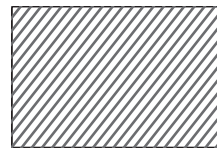
Lens Color	Button Color	AML56-N Series Full Button with Lens
		
Red	Red	AML56-N10RR
Red	Green	AML56-N10RG
Red	White	AML56-N10RW
Red	Black	AML56-N10RK
Clear	Red	AML56-N10TR
Clear	White	AML56-N10TW
Clear	Black	AML56-N10TK
Yellow	Black	AML56-N10YK

Figure 33. AML35 Paddle and AML36 Rocker Series Dimensions mm [in] or mm/in



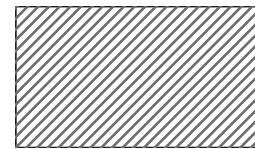
Panel Cutouts for AML20 and AML30 Series Paddles and Rockers

WITHOUT BARRIERS



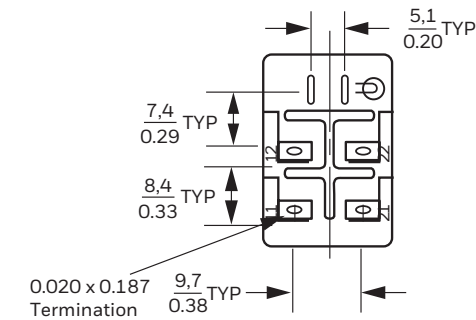
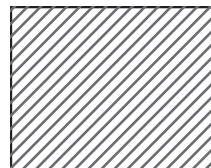
28,98 [1.141] x 19,05 [0.750]

WITH SHORT BARRIERS<sup>1</sup>



33,27 [1.310] x 19,05 [0.750]

WITH LONG BARRIERS<sup>1</sup>



<sup>1</sup> Table 47 describes barrier options. Barriers are designed to prevent inadvertent actuation of adjacent-mounted switches.

Figure 42. AML34 Series Nomenclature

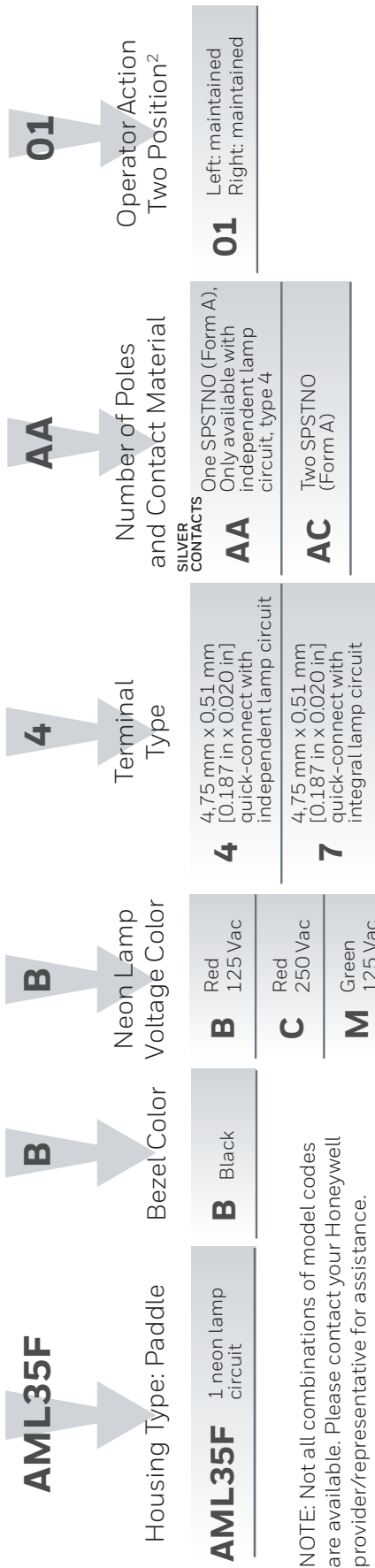
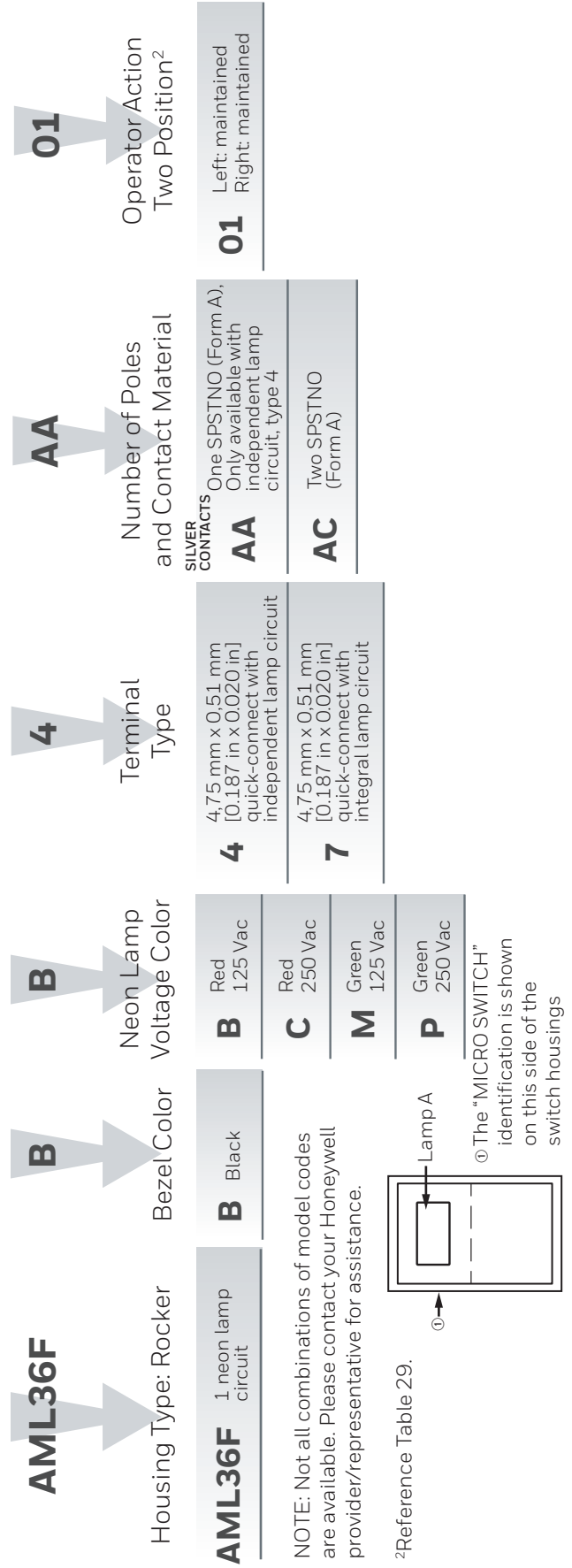


Figure 35. AML36 Series Nomenclature

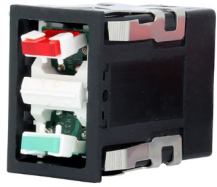


**Figure 36. AML55 Covers for AML35 Series Paddle Switches and AML56 Buttons for AML36 Series Rocker Switches with Neon Display Nomenclature**

<b>AML55-N</b> Paddle Switch Cover or Rocker Switch Button		<b>10</b> Display Type	<b>R</b> Lens Color (for neon window)	<b>G</b> Cover/Button Color
<b>AML55-N</b>	Full paddle cover with window for neon display	<b>10</b> Transmitted color	<b>T</b> Clear	<b>R</b> Red
<b>AML56-N</b>	Full rocker button with window for neon display		<b>R</b> Red	<b>Y</b> Yellow
				<b>G</b> Green
				<b>B</b> Blue
				<b>W</b> White
				<b>K</b> Black
				<b>L</b> Gray

NOTE: Not all combinations of model codes are available. Please contact your Honeywell provider/representative for assistance.

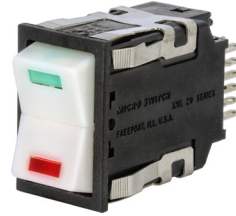
**Operator with Integral Contact Block**  
(see Tables 32, 33, & 34)



**Button**  
(see Tables 35 & 36)

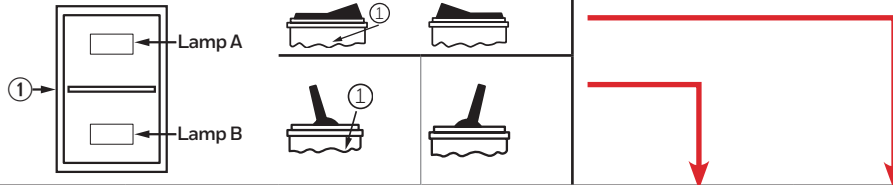


**Complete Unit**



- Catalog Listing with 0.110 x 0.020 quick connect or solder terminals

**Table 32. Integral LED Lighted AML25 Series Paddle and AML26 Series Rocker Switches Catalog Listings (Two Position)**



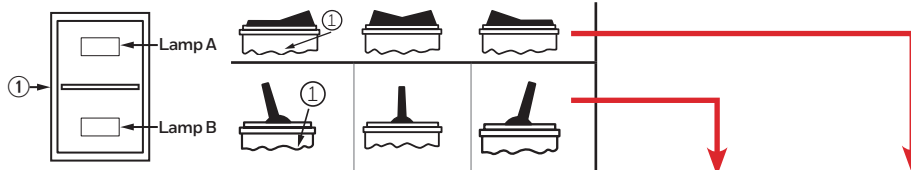
No. of Poles	Contact Material	Supply voltage for integral LED with color as noted		Circuits Left Position	Circuits Right Position	Paddle Switch Cat. Listings	Rocker Switch Cat. Listings	Notes
		Lamp "A"	Lamp "B"					
1	Silver	V*, Red	No lamp circuit	1-2	2-3	AML25FBB2AA01RX	-	One Lamp Circuit
1	Silver	5 V, Red	No lamp circuit	1-2	2-3	-	AML26FBC2AA01RX	One Lamp Circuit
1	Silver	24 V, Green	24 V, Red	1-2	2-3	AML25GBF2AA01GR	-	Two Lamp Circuits
1	Silver	24 V, Green	24 V, Red	1-2	2-3	AML25GBF8AA01GR	-	Two Lamp Circuits w/ LED diode protection
1	Silver	24 V, Red	24 V, Green	1-2	2-3	-	AML26GBF2AA01RG	Two Lamp Circuits
1	Silver	24 V, Green	No lamp circuit	1-2 Mom.	2-3	AML25FBF2AA02GX	-	One Lamp Circuit
1	Silver	24 V, Red	24 V, Green	1-2 Mom.	2-3	-	AML26GBF2AA02RG	Two Lamp Circuits
1	Silver	24 V, Green	24 V, Red	1-2 Mom.	2-3	AML25GBF8AA02GR	-	Two Lamp Circuits w/ LED diode protection
1	Silver	24 V, Red	24 V, Green	1-2 Mom.	2-3	AML25GBF8AA02RG	-	Two Lamp Circuits w/ LED diode protection
1	Silver	24 V, Green	24 V, Red	1-2	2-3 Mom.	AML25GBF2AA03GR	-	Two Lamp Circuits
1	Silver	24 V, Red	24 V, Green	1-2	2-3 Mom.	AML25GBF2AA03RG	AML26GBF2AA03RG	Two Lamp Circuits
2	Silver	24 V, Red	No lamp circuit	1-2, 4-5	2-3, 5-6	-	AML26FBF2CA01RX	One Lamp Circuit
2	Silver	15 V, Green	15 V, Red	1-2, 4-5	2-3, 5-6	-	AML26GBE2CA01GR	Two Lamp Circuits
2	Silver	24 V, Green	24 V, Red	1-2, 4-5	2-3, 5-6	AML25GBF2CA01GR	AML26GBF2CA01GR	Two Lamp Circuits
2	Silver	24 V, Red	24 V, Green	1-2, 4-5	2-3, 5-6	AML25GBF2CA01RG	AML26GBF2CA01RG	Two Lamp Circuits
2	Silver	24 V, Green	24 V, Red	1-2, 4-5	2-3, 5-6 Mom.	AML25GBF2CA03GR	AML26GBF2CA03GR	Two Lamp Circuits
2	Gold	24 V, Green	24 V, Red	1-2, 4-5	2-3, 5-6 Mom.	-	AML26GBF2DA03GR	Two Lamp Circuits
2	Silver	24 V, Red	24 V, Green	1-2, 4-5	2-3, 5-6 Mom.	AML25GBF2CA03RG	-	Two Lamp Circuits
2	Silver	24 V, Red	24 V, Green	1-2, 4-5 Mom.	2-3, 5-6	AML25GBF2CA02RG	AML26GBF2CA02RG	Two Lamp Circuits

① MICRO SWITCH identification on this side of switch housing

Note: All switch positions are maintained except where noted as Mom. (momentary)

\*The LED does not include an internal resistor. A suitable external resistor must be added to the LED circuit for a nominal current of 20 mA

**Table 33. Integral LED Lighted AML25 Series Paddle and AML26 Series Rocker Switches Catalog Listings (Three Position)**



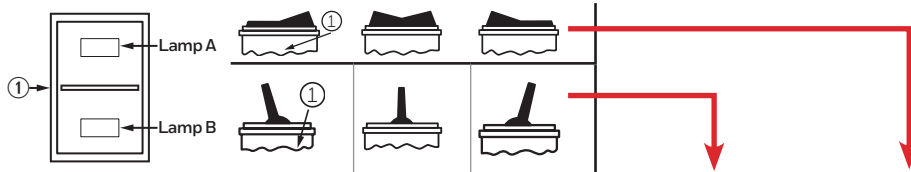
No. of Poles	Contact Material	Supply voltage for integral LED with color		Circuits Left Position	Circuits Center Position	Circuits Right Position	Paddle Switch Cat. Listings	Rocker Switch Cat. Listings	Notes
		Lamp "A"	Lamp "B"						
1	Silver	5 V, Green	5 V, Red	1-2	OFF	2-3	-	AML26GBC2AA04GR	Two Lamp Circuits
1	Silver	24 V, Green	24 V, Red	1-2	OFF	2-3	AML25GBF2AA04GR	-	Two Lamp Circuits
1	Silver	24 V, Red	24 V, Green	1-2	OFF	2-3	-	AML26GBF2AA04RG	Two Lamp Circuits
1	Silver	24 V, Red	24 V, Green	1-2	OFF	2-3	AML25GBF8AA04RG	-	Two Lamp Circuits with LED diode protection
1	Silver	5 V, Green	No lamp circuit	1-2, Mom.	OFF	2-3, Mom.	AML25FBC2AA05GX	-	One Lamp Circuit
1	Silver	24 V, Green	No lamp circuit	1-2, Mom.	OFF	2-3, Mom.	AML25FBF2AA05GX	-	One Lamp Circuit
1	Silver	24 V, Red	No lamp circuit	1-2, Mom.	OFF	2-3, Mom.	AML25FBF2AA05RX	-	One Lamp Circuit
1	Silver	24 V, Yellow	No lamp circuit	1-2, Mom.	OFF	2-3, Mom.	AML25FBF2AA05YX	-	One Lamp Circuit
1	Silver	No lamp circuit	24 V, Red	1-2, Mom.	OFF	2-3, Mom.	-	AML26FBF2AA05XR	One Lamp Circuit
1	Gold	24 V, Red	No lamp circuit	1-2, Mom.	OFF	2-3, Mom.	-	AML26FBF2BA05RX	One Lamp Circuit
1	Silver	24 V, Yellow	No lamp circuit	1-2, Mom.	OFF	2-3, Mom.	-	AML26FBF2AA05YX	One Lamp Circuit
1	Silver	V*, Red	V*, Green	1-2, Mom.	OFF	2-3, Mom.	-	AML26GGB2AA05RG	Two Lamp Circuits
1	Silver	24 V, Green	24 V, Red	1-2, Mom.	OFF	2-3, Mom.	AML25GBF2AA05GR	-	Two Lamp Circuits
1	Silver	24 V, Red	24 V, Green	1-2, Mom.	OFF	2-3, Mom.	AML25GBF2AA05RG	AML26GBF2AA05RG	Two Lamp Circuits
1	Silver	24 V, Red	24 V, Green	1-2, Mom.	OFF	2-3, Mom.	-	AML26GBF8AA05RG	Two Lamp Circuits with LED diode protection
1	Gold	24 V, Red	24 V, Green	1-2, Mom.	OFF	2-3, Mom.	AML25GBF2BA05RG	AML26GBF2BA05RG	Two Lamp Circuits
1	Silver	24 V, Red	24 V, Green	1-2	OFF	2-3, Mom.	AML25GBF2AA06RG	-	Two Lamp Circuits
1	Silver	24 V, Green	24 V, Red	1-2	OFF	2-3, Mom.	-	AML26GBF8AA06GR	Two Lamp Circuits with LED diode protection
1	Gold	24 V, Red	24 V, Green	1-2, Mom.	OFF	2-3	AML25GBF2BA07RG	-	Two Lamp Circuits
1	Silver	24 V, Red	24 V, Green	1-2, Mom.	OFF	2-3	AML25GBF8AA07RG	AML26GBF8AA07RG	Two Lamp Circuits with LED diode protection
1	Silver	24 V, Green	24 V, Red	1-2, Mom.	OFF	2-3	AML25GBF2AA07GR	-	Two Lamp Circuits
1	Silver	24 V, Green	24 V, Red	1-2, Mom.	OFF	2-3	AML25GBF8AA07GR	-	Two Lamp Circuits with LED diode protection

① MICRO SWITCH identification on this side of switch housing

Note: All switch positions are maintained except where noted as Mom. (momentary)

\*The LED does not include an internal resistor. A suitable external resistor must be added to the LED circuit for a nominal current of 20 mA

**Table 34. Integral LED Lighted AML25 Series Paddle and AML26 Series Rocker Series Switches Catalog Listings (Three Position)**



No. of Poles	Contact Material	Supply voltage for integral LED with color		Circuits Left Position	Circuits Center Position	Circuits Right Position	Paddle Switch Cat. Listings	Rocker Switch Cat. Listings	Notes
		Lamp "A"	Lamp "B"						
2	Silver	24 V, Red	No lamp circuit	1-2, 4-5	2-3, 4-5	2-3, 5-6	AML25FBF2CA04RX	-	One Lamp Circuit
2	Silver	24 V, Red	24 V, Green	1-2, 4-5	2-3, 4-5	2-3, 5-6	AML25GBF2CA04RG	AML26GBF2CA04RG	Two Lamp Circuits
2	Silver	24 V, Red	24 V, Green	1-2, 4-5	2-3, 4-5	2-3, 5-6	-	AML26GBF8CA04RG	Two Lamp Circuits with LED diode protection
2	Silver	24 V, Green	24 V, Red	1-2, 4-5	2-3, 4-5	2-3, 5-6	AML25GBF2CA04GR	-	Two Lamp Circuits
2	Silver	24 V, Green	24 V, Red	1-2, 4-5	2-3, 4-5	2-3, 5-6	AML25GBF8CA04GR	AML26GBF8CA04GR	Two Lamp Circuits with LED diode protection
2	Gold	5 V, Yellow	5 V, Yellow	1-2, 4-5	2-3, 4-5	2-3, 5-6	AML25GBDA04YY	-	Two Lamp Circuits
2	Silver	V*, Red	No lamp circuit	1-2, 4-5 Mom.	2-3, 4-5	2-3, 5-6 Mom.	AML25FBB2CA05RX	-	One Lamp Circuit
2	Silver	15 V, Yellow	No lamp circuit	1-2, 4-5 Mom.	2-3, 4-5	2-3, 5-6 Mom.	AML25FBE2CA05YX	-	One Lamp Circuit
2	Silver	24 V, Green	No lamp circuit	1-2, 4-5 Mom.	2-3, 4-5	2-3, 5-6 Mom.	AML25FBF2CA05GX	-	One Lamp Circuit
2	Silver	24 V, Green	24 V, Red	1-2, 4-5 Mom.	2-3, 4-5	2-3, 5-6 Mom.	AML25GBF2CA05GR	AML26GBF2CA05GR	Two Lamp Circuits
2	Silver	24 V, Red	24 V, Green	1-2, 4-5 Mom.	2-3, 4-5	2-3, 5-6 Mom.	AML25GBF2CA05RG	AML26GBF2CA05RG	Two Lamp Circuits
2	Silver	24 V, Green	24 V, Red	1-2, 4-5	2-3, 4-5	2-3, 5-6 Mom.	AML25GBF2CA06GR	-	Two Lamp Circuits
2	Silver	24 V, Red	24 V, Green	1-2, 4-5	2-3, 4-5	2-3, 5-6 Mom.	AML25GBF2CA06RG	AML26GBF2CA06RG	Two Lamp Circuits
2	Silver	24 V, Red	24 V, Green	1-2, 4-5 Mom.	2-3, 4-5	2-3, 5-6	AML25GBF2CA07RG	AML26GBF2CA07RG	Two Lamp Circuits
2	Silver	24 V, Red	24 V, Green	1-2, 4-5 Mom.	2-3, 4-5	2-3, 5-6	-	AML26GBF8CA07RG	Two Lamp Circuits with LED diode protection
2	Silver	24 V, Red	24 V, Yellow	1-2, 4-5 Mom.	2-3, 4-5	2-3, 5-6	AML25GBF2CA07RY	-	Two Lamp Circuits

① MICRO SWITCH identification on this side of switch housing

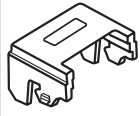
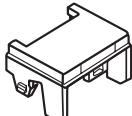
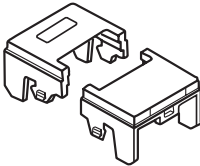
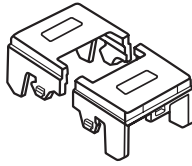
\*The LED does not include an internal resistor. A suitable external resistor must be added to the LED circuit for a nominal current of 20 mA

Note: All switch positions are maintained except where noted as Mom. (momentary)

Note: AML25 Series Paddle Switches require AML55 Series Paddle Switch Covers from table 35



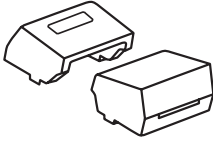
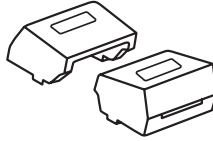
Note: AML26 Series Rocker Switches require AML56 Series Rocker Switch Buttons from table 36

**Table 35. AML55 Series Paddle Switch Covers without Legends for AML25 Series Switches with LED Displays**

Cover Color	AML55-E Series (1/2 Cover) for 1 LED	AML53-E Series (1/2 Cover) without LED	AML55-T Series Two Piece Cover (For one LED)**	AML55-H Series Two Piece Cover (For two LEDs)
				
Red	AML55-E10R	AML53-E10R	-	AML55-H10RR
Yellow	AML55-E10Y	AML53-E10Y	AML55-T10YY	-
Green	AML55-E10G	AML53-E10G	AML55-T10GG	AML55-H10GG
Blue	-	AML53-E10B	AML55-T10BB	AML55-H10BB
White	-	AML53-E10W	-	-
Red/Green	-	-	-	AML55-H10RG
Green/Red	-	-	-	AML55-H10GR

For AML55 Series Paddle Switch Covers Style E, H, or T from table above with Legends contact the local Honeywell source

**Table 36. AML56 Series Rocker Switch Buttons without Legends for AML26 Series Switches with LED Displays**

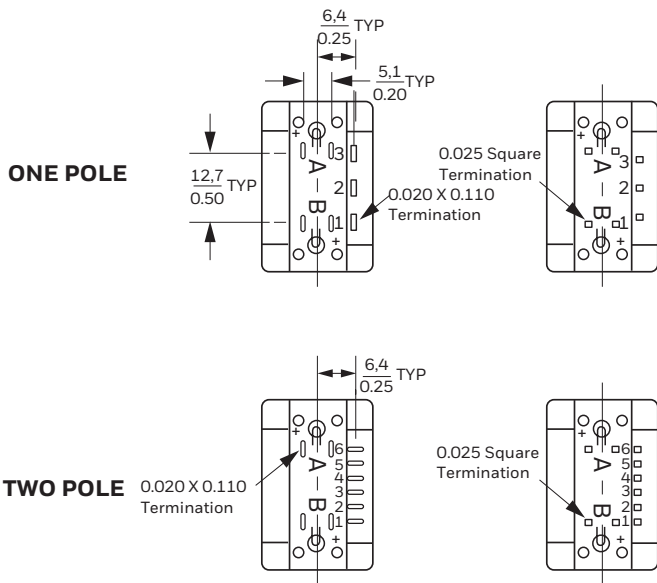
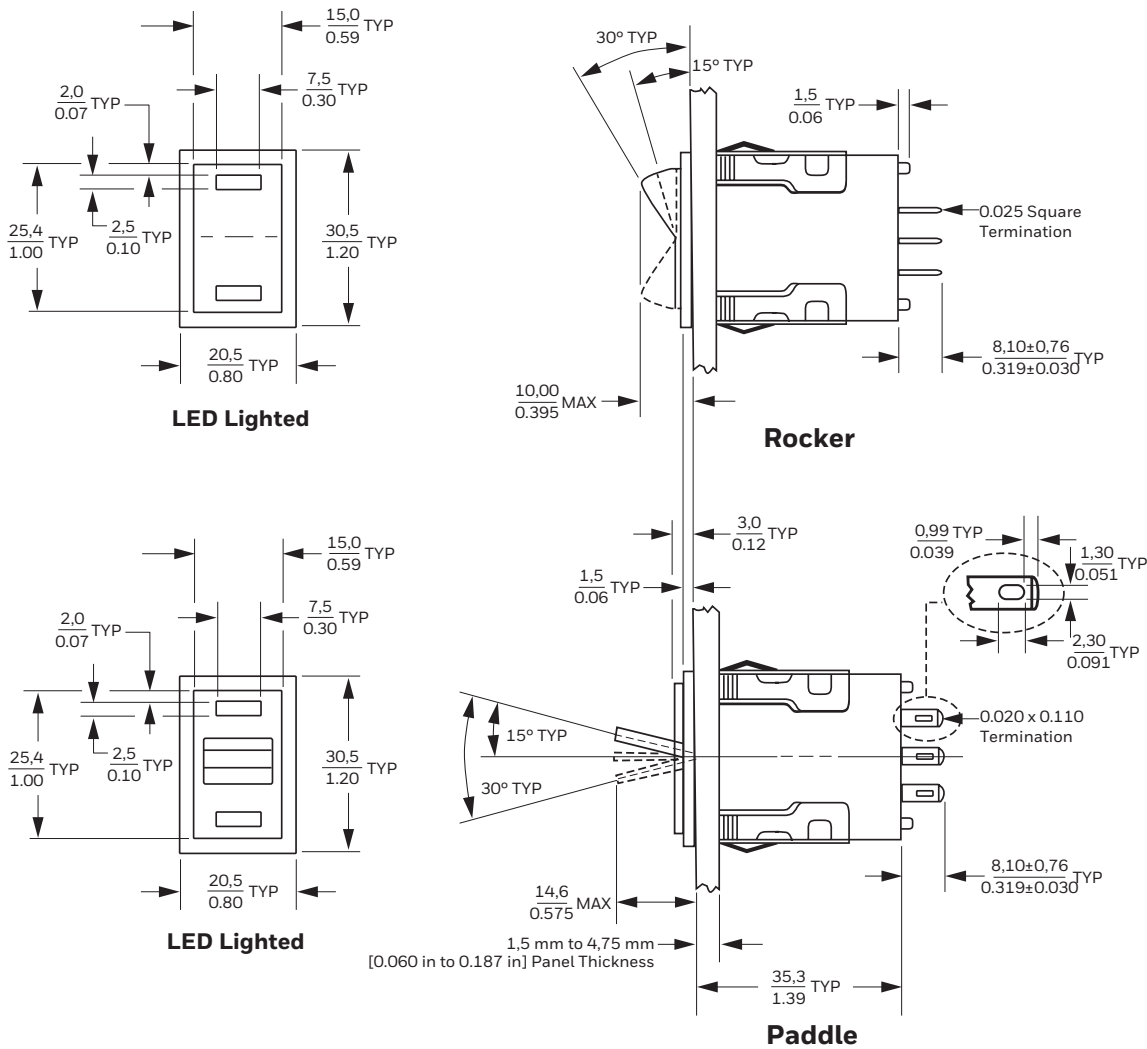
Cover Color	AML56-E Series (1/2 Button) for 1 LED	AML54-E Series (1/2 Button) without LED	AML56-T Series Two Piece Button (for one LED)**	AML56-H Series Two Piece Button (for two LEDs)
				
Red	AML56-E10R	AML54-E10R	AML56-T10RR	AML56-H10RR
Yellow	-	-	AML56-T10YY	-
Green	AML56-E10G	AML54-E10G	AML56-T10GG	-
Blue	-	-	-	AML56-H10BB
White	-	AML54-E10W	-	AML56-H10WW
Amber	-	-	-	-
Black	AML56-E10K	AML54-E10K	AML56-T10BB	AML56-H10KK
Red/Green	-	-	AML56-T10RG**	AML56-H10RG
Green/Red	-	-	-	AML56-H10GR

For AML56 Series Rocker Switch Covers Style E, H, or T from table above with Legends contact the local Honeywell source

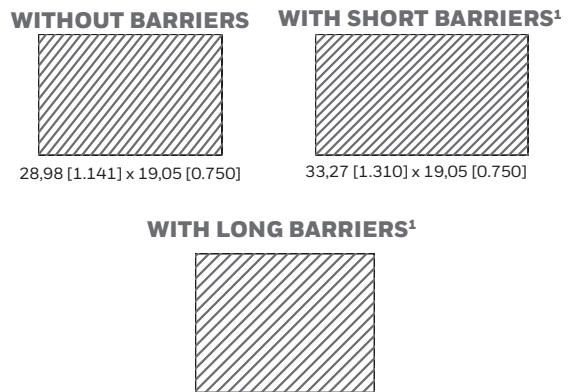
\*\*First color referenced in catalog listing has window opening for LED display. For example, AML56-T10RG has a LED window opening in the red cover while the green cover has no LED window opening



Figure 37. AML25 and AML26 Series Dimensions, mm [in] or mm/in



**Panel Cutouts for AML20 and AML30 Series Paddles and Rockers**



<sup>1</sup> Table 47 describes barrier options. Barriers are designed to prevent inadvertent actuation of adjacent-mounted switches.

Figure 38. AML25 Series Nomenclature

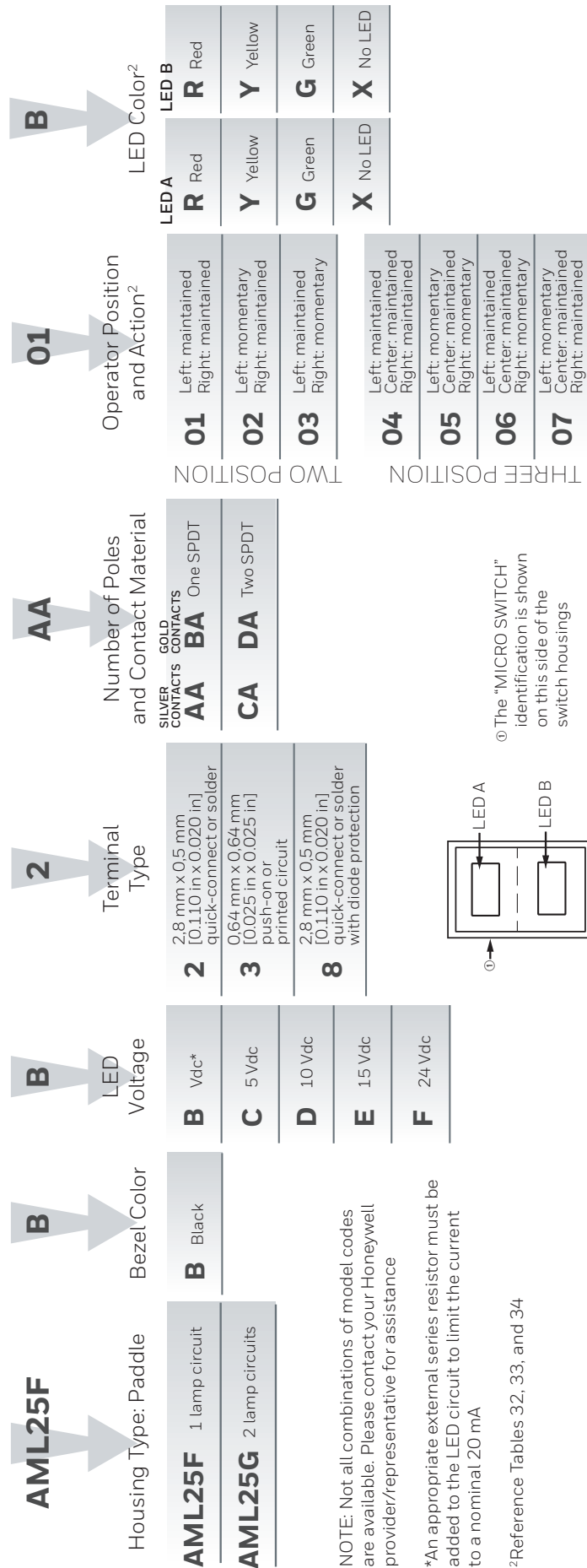
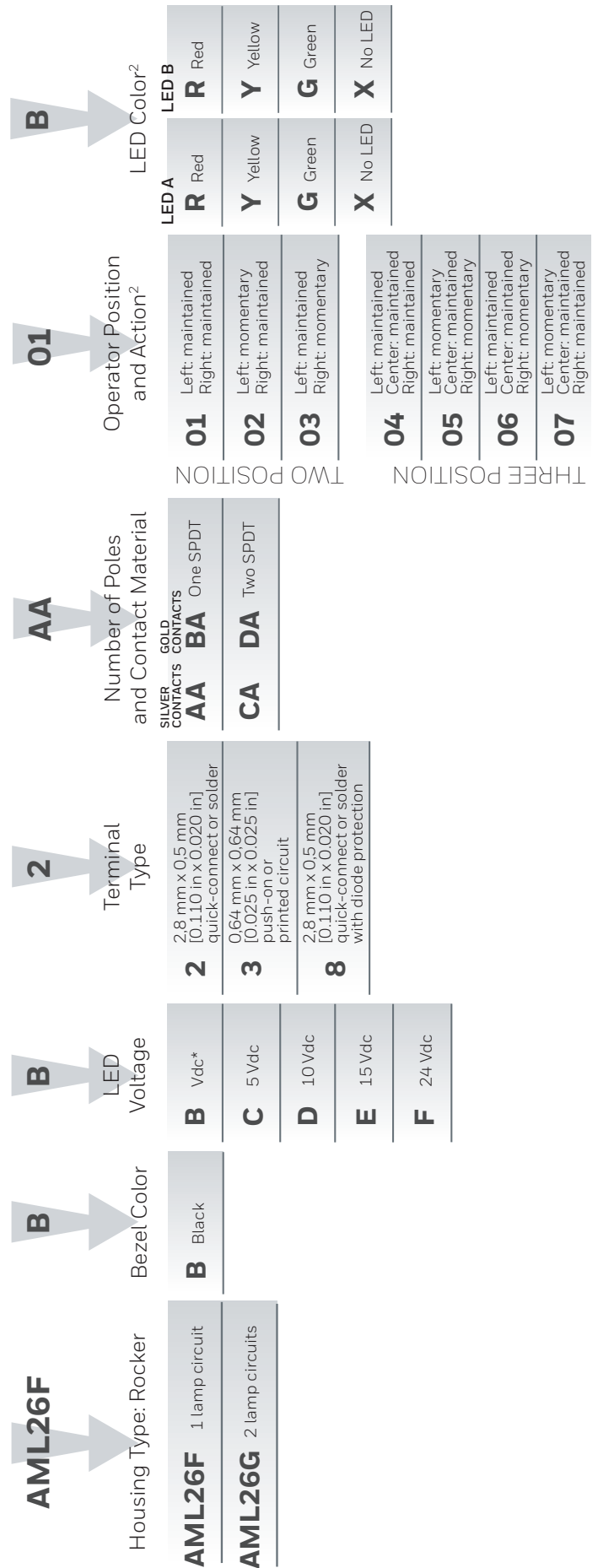


Figure 39. AML26 Series Nomenclature



**Figure 40. AML55 Covers for AML25 Series Paddle Switches and AML56 Buttons for AML26 Series Rocker Switches with LED Display Nomenclature**

<p><b>AML55-H</b></p> <p>Paddle Switch Cover or Rocker Type</p>	<p><b>10</b></p> <p>Display Type</p>	<p><b>G</b></p> <p>1/2 cover with LED or LED side of 2 piece</p>	<p><b>G</b></p> <p>Other side of 2-piece</p>
<p><b>AML55-E<sup>1</sup></b> 1/2 cover with LED window</p>	<p><b>10</b> Transmitted color</p>	<p><b>R</b> Red</p>	<p><b>R</b> Red</p>
<p><b>AML55-T</b> Two-piece cover for 1 LED</p>		<p><b>Y</b> Yellow</p>	<p><b>Y</b> Yellow</p>
<p><b>AML55-H</b> Two-piece cover for 2 LEDs</p>		<p><b>G</b> Green</p>	<p><b>G</b> Green</p>
<p><b>AML56-E<sup>2</sup></b> 1/2 button with LED window</p>		<p><b>B</b> Blue</p>	<p><b>B</b> Blue</p>
<p><b>AML56-T</b> Two-piece button for 1 LED</p>		<p><b>W</b> White</p>	<p><b>W</b> White</p>
<p><b>AML56-H</b> Two-piece button for 2 LEDs</p>		<p><b>K</b> Black</p>	<p><b>K</b> Black</p>
		<p><b>L</b> Gray</p>	<p><b>L</b> Gray</p>

NOTE: Not all combinations of model codes are available. Please contact your Honeywell provider/representative for assistance

<sup>1</sup>To order a 1/2 cover without a LED window, specify an AML53-E10\_ cover from Table 35.

<sup>2</sup>To order a 1/2 button without a LED window, specify an AML54-E10\_ from Table 36.



- Catalog Listing with 0.110 x 0.020 quick connect or solder terminals
- Includes two keys with switch

**Table 37. AML27 Series Key Switches (Two Position)**

No. of Poles	Contact Material	Key Withdrawal Position/s	Key Code (3 digit number marked on key)	Circuits Center Position	Circuits Right Position (CW)	Catalog Listing
1PDT	Silver	Center	BA (110)	2-3	1-2	AML27ABK2AA21BA
1PDT	Gold	Center	BA (110)	2-3	1-2	AML27ABK2BA21BA
1PDT	Silver	Center	BA (110)	2-3	1-2 Mom.	AML27ABK2AA23BA
1PDT	Silver	Center	BK (101)	2-3	1-2 Mom.	AML27ABK2AA23BK
1PDT	Silver	Center & Right	BA (110)	2-3	1-2	AML27ABK2AA22BA
1PDT	Gold	Center & Right	BA (110)	2-3	1-2	AML27ABK2BA22BA
1PDT	Silver	Center & Right	BB (109)	2-3	1-2	AML27ABK2AA22BB
2PDT	Silver	Center	BA (110)	2-3, 5-6	1-2, 4-5	AML27ABK2AC21BA
2PDT	Gold	Center	BA (110)	2-3, 5-6	1-2, 4-5	AML27ABK2BC21BA
2PDT	Silver	Center	BB (109)	2-3, 5-6	1-2, 4-5	AML27ABK2AC21BB
2PDT	Gold	Center	BB (109)	2-3, 5-6	1-2, 4-5	AML27ABK2BC21BB
2PDT	Silver	Center & Right	BA (110)	2-3, 5-6	1-2, 4-5	AML27ABK2AC22BA
2PDT	Silver	Center & Right	BB (109)	2-3, 5-6	1-2, 4-5	AML27ABK2AC22BB
2PDT	Silver	Center	BA (110)	2-3, 5-6	1-2, 4-5 Mom.	AML27ABK2AC23BA

Note: All switch positions are maintained except where noted as Mom. (momentary)

**Table 38. AML27 Series Key Switches (Three Position)**

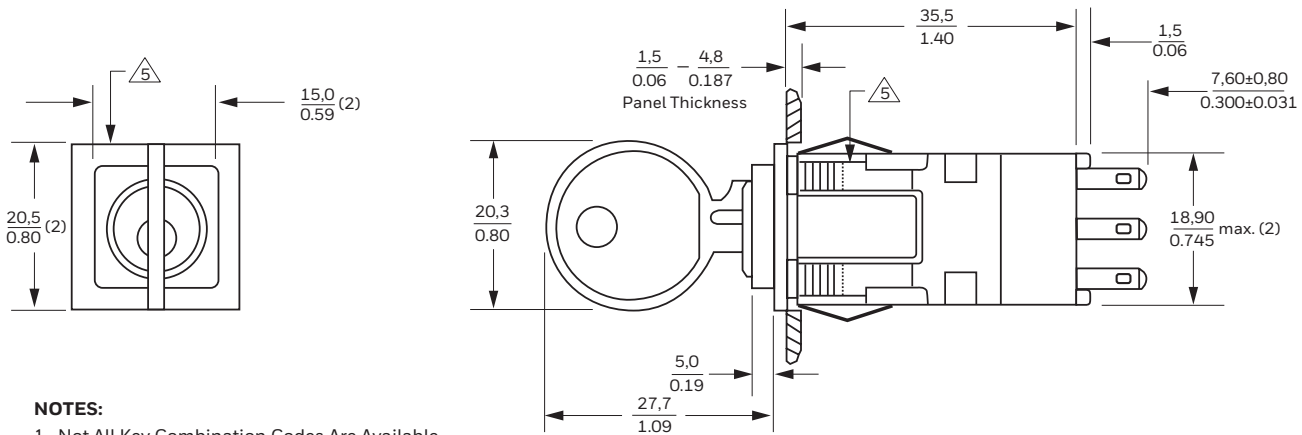
No. of Poles	Contact Material	Key Withdrawal Position/s	Key Code (3 digit number marked on key)	Circuits Left Position (CCW)	Circuits Center Position	Circuits Right Position (CW)	Catalog Listing
2PDT	Silver	Center	BB (109)	2-3, 4-5	2-3, 5-6	1-2, 4-5	AML27ABK2AC24BB
	Silver	Center & Right	BA (110)	2-3, 4-5	2-3, 5-6	1-2, 4-5	AML27ABK2AC28BA
	Silver	Left & Center	BA (110)	2-3, 4-5	2-3, 5-6	1-2, 4-5	AML27ABK2AC29BA
	Gold	Left, Center & Right	BA (110)	2-3, 4-5	2-3, 5-6	1-2, 4-5	AML27ABK2BC26BA
	Silver	Left	BL (111)	2-3, 4-5	2-3, 5-6	1-2, 4-5 Mom.	AML27ABK2AC31BL
	Gold	Left & Center	BA (110)	2-3, 4-5	2-3, 5-6	1-2, 4-5 Mom.	AML27ABK2BC30BA


Note: All switch positions are maintained except where noted as Mom. (momentary)  
Circuits remain the same with key-in or key-out

**Replacement Keys (2 keys per catalog listing)**

Key Code	3 Digit number marked on key	Catalog Listing
BA	110	30PA101-AML
BB	109	30PA102-AML

Figure 41. AML27 Series Dimensions, mm [in] or mm/in

**NOTES:**

- 1 Not All Key Combination Codes Are Available
  - 2 Silver and Gold Contact Options
  - 3 One Pole and Two Pole Options
  - 4 One Pole Circuitry Not Furnished with 3 Position Units
-  E.S.D. Conductor Location

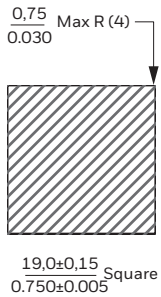
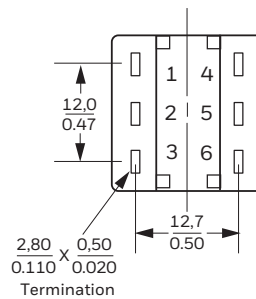
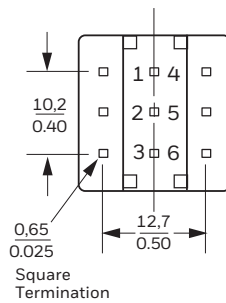
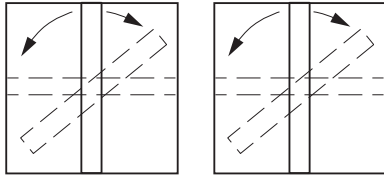
**Panel Cutout****Termination AML 27 Series**

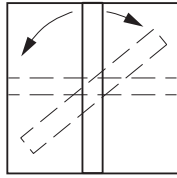
Figure 42. AML27 Series Operating Action

Operating Action (Key Out In Center Position, Except Where Noted)



“30”

3 Position, CW-MOM 60°  
90° Maint. CCW  
Key Out In Center  
and CCW Positions

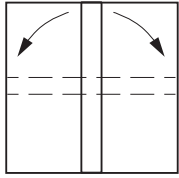


“31”

3 Position, CW-MOM 60°  
90° Maint. CCW  
Key Out In  
CCW Position

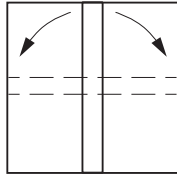
Two Position Units

	Released Position	Operated Position
1 Pole	Circle 1-2 Open Circle 2-3 Closed	Circle 1-2 Closed Circle 2-3 Open
2 Pole	Circle 1-2, 4-5 Open Circle 2-3, 5-6 Closed	Circle 1-2, 4-5 Closed Circle 2-3, 5-6 Open



“28”

3 Position, Maint.  
90° CW, 90° CCW  
Key Out In Center  
and CW Positions

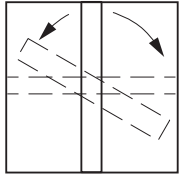


“29”

3 Position, Maint.  
90° CW, 90° CCW  
Key Out In Center  
and CCW Positions

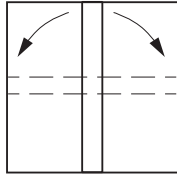
Three Position Units

	CCW	Center	CW
2 Pole	Circle 1-2, 5-6 Open Circle 2-3, 4-5 Closed	Circle 1-2, 4-5 Open Circle 2-3, 5-6 Closed	Circle 1-2, 4-5 Closed Circle 2-3, 5-6 Open



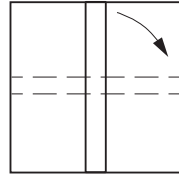
“27”

3 Position, CCW-MOM 60°  
90° Maint. CW  
Key Out In Center  
and CCW Positions



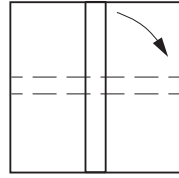
“26”

3 Position Maint.  
90° CW, 90° CCW  
Key Out All  
3 Positions



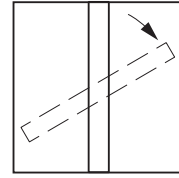
“21”

2 Position Maint.  
90° CW



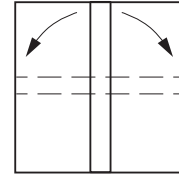
“22”

2 Position Maint.  
90° CW, Key Out In  
Both Positions



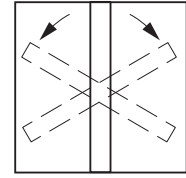
“23”

2 Position, MOM  
60° CW



“24”

3 Position, Maint.  
90° CW, 90° CCW



“25”

3 Position, MOM  
60° CW and 60° CCW

Figure 43. AML27 Series Nomenclature

AML27		BK	2	AA	24	BA
Housing Type		Bezel Color	Terminal Type	Number of Poles and Contact Material	Operator Action and Key Withdrawal*	Key Code
				SILVER CONTACTS GOLD CONTACTS	CCW CEN. CW	(# marked on key)
<b>AML27</b>	Unlighted, key switch	<b>BK</b> Black	<b>2</b> 2.8 mm x 0.5 mm [0.110 in x 0.020 in] quick-connect or solder	<b>AA</b> BA One SPDT	<b>21</b> None Maint.* Maint.	<b>BA</b> 110
			<b>3</b> 0.64 mm x 0.64 mm [0.025 in x 0.025 in] push-on or printed circuit	<b>AC</b> BC Two SPDT	<b>22</b> None Maint.* Maint.*	<b>BB</b> 109
					<b>23</b> None Maint.* Mom.	
					<b>24</b> Maint. Maint.* Maint.	
					<b>25</b> Mom. Maint.* Mom.	
					<b>26</b> Maint.* Maint.* Maint.*	
					<b>27</b> Mom. Maint.* Maint.*	
					<b>28</b> Maint. Maint.* Maint.*	
					<b>29</b> Maint.* Maint.* Maint.	
					<b>30</b> Maint.* Maint.* Mom.	
					<b>31</b> Maint.* Maint. Mom.	

TWO POSITION

THREE POSITION

NOTE: Not all combinations of model codes are available. Please contact your Honeywell provider/representative for assistance.

\* Key withdrawal positions  
 \*\* For other keycodes, contact your local Honeywell provider

**Indicator**

(see Tables 39 & 40)



**Button**

(see Tables 41 & 42)



**Complete Unit**



- 0.110 in x 0.020 in quick connect or solder terminals

**Table 39. AML41 Series Button-Style Indicator Catalog Listings (Incandescent lamps)**

Replaceable Incandescent Lamp Type (T-1 3/4 wedge base)	Square Housing 1 lamp ckt	Square Housing 2 lamp circuits	Rectangular Housing 1 lamp ckt	Rectangular Housing 2 lamp circuits
No lamp provided	AML41CBA2	AML41DBA2	AML41FBA2	AML41GBA2
28 V lamp (#85)	AML41CBE2	AML41DBE2	AML41FBE2	AML41GBE2

AML41C Series indicator, select AML51-C style button per Table 42

AML41D Series indicator, select AML51-D1ORG(red/green) button per Table 42

AML41F Series indicator, select AML51-F style button per Table 42

AML41G Series indicator, select AML51-G style button per Table 42

**Table 40. AML41 Series Lens-Style Indicators (requires an AML51 Series style “lens” cap from table below)**

Replaceable Incandescent Lamp Type (T-1 3/4 wedge base)	Rectangular Housing 1 lamp ckt	Rectangular Housing 2 lamp circuits	Rectangular Housing 3 lamp circuits
No lamp provided	AML41JBA2	AML41KBA2	AML41LBA2
28 V lamp (#85)	-	AML41KBE2	AML41LBE2

AML41J Series indicator, select AML51-J style lens per Table 41

AML41K Series indicator, select AML51-K style lens per Table 41

AML41L Series indicator, select AML51-L style lens per Table 41

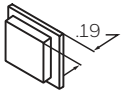
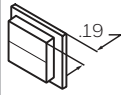
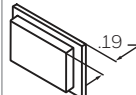
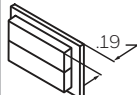
**Table 41. AML51 Series Lens Caps without Legends for AML41J, AML41K, or AML41L Series Rectangular Housing Indicators\*\*\***

Transmitted Color	AML51-J Series	AML51-K Series	AML51-L Series
	Lens cap for 1 lamp ckt	Lens cap for 2 lamps circuits	Lens cap for 3 lamp circuits
Red	AML51-J10R	-	-
Yellow	AML51-J10Y	-	-
Green	AML51-J10G	-	-
Blue	-	-	-
White	AML51-J10W	-	-
Amber	-	-	-
Red/Green	-	AML51-K10RG	-
<b>Two piece button (clear cap &amp; color insert/s)</b>			
Green	AML51-J11G	-	-
Amber	AML51-J11A	-	-
Green/Red	-	AML51-K11GR	-

\*\*\*For AML51Series Lens Style J, K or L with Legends contact the local Honeywell source



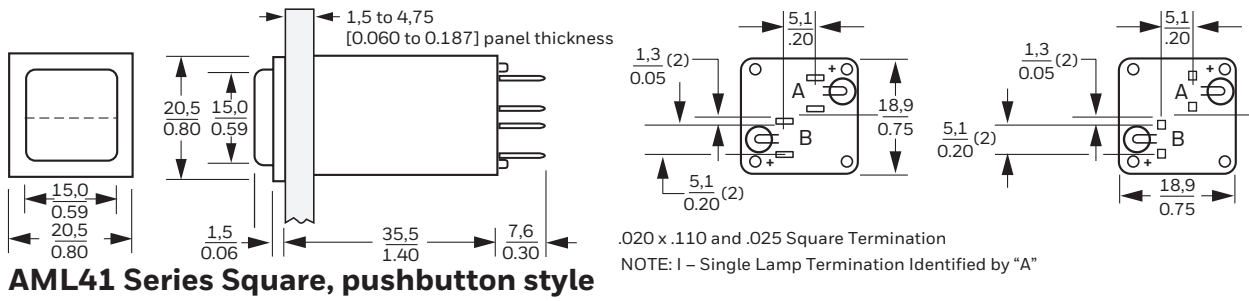
**Table 42. AML51 Series Buttons without Legends, for use with AML41C, AML41D, AML41F or AML41G Series Indicators\*\***

Transmitted Color	AML51-C Series Button for square housing, 1 lamp ckt	AML51-D Series Button for square housing, 2 lamp ckts	AML51-F Series Button for rectangular housing, 1 lamp ckt	AML51-G Series Button for rectangular housing, 2 lamp ckts
				
Red	AML51-C10R	-	AML51-F10R	AML51-G10RR
Yellow	AML51-C10Y	-	AML51-F10Y	-
Green	AML51-C10G	-	AML51-F10G	-
Blue	AML51-C10B	-	AML51-F10B	-
White	AML51-C10W	-	AML51-F10W	AML51-G10WW
Amber	AML51-C10A	-	AML51-F10A	-
Red/Yellow	-	-	-	AML51-G10RY
Red/Green	-	AML51-D10RG	-	AML51-G10RG
Red/White	-	-	-	AML51-G10RW
Yellow/Green	-	-	-	AML51-G10YG
Green/Yellow	-	-	-	AML51-G10GY
White/Red	-	-	-	AML51-G10WR
White/Green	-	-	-	AML51-G10WG
<b>Two piece button (clear cap &amp; color insert/s)</b>				
Red	AML51-C11R	-	AML51-F11R	-
Yellow	AML51-C11Y	-	AML51-F11Y	-
Green	AML51-C11G	-	AML51-F11G	-
Blue	AML51-C11B	-	AML51-F11B	AML51-G11BB
White	AML51-C11W	-	AML51-F11W	AML51-G11WW
Amber	-	-	AML51-F11A	-
Red/Green	-	-	-	AML51-G11RG
Yellow/White	-	-	-	AML51-G11YW
Green/Red	-	-	-	AML51-G11GR
<b>Dead front, two piece button (gray cap &amp; color insert)</b>				
Red	AML51-C30R	-	-	-
Yellow	-	-	-	-
Green	AML51-C30G	-	-	-
Blue	-	-	-	-
White	AML51-C30W	-	-	-
Amber	AML51-C30A	-	-	-
Red/Green	-	-	-	AML51-G30RG
<b>Projected color, two piece button (white cap and color insert*)</b>				
Red	AML51-C50R	-	AML51-F50R	-
Yellow	AML51-C50Y	-	-	-
Green	AML51-C50G	-	AML51-F50G	-
Blue	-	-	-	-
White*	-	-	AML51-F50W	AML51-G50WW
Amber	AML51-C50A	-	-	-
White*/Blue	-	-	-	AML51-G50WB

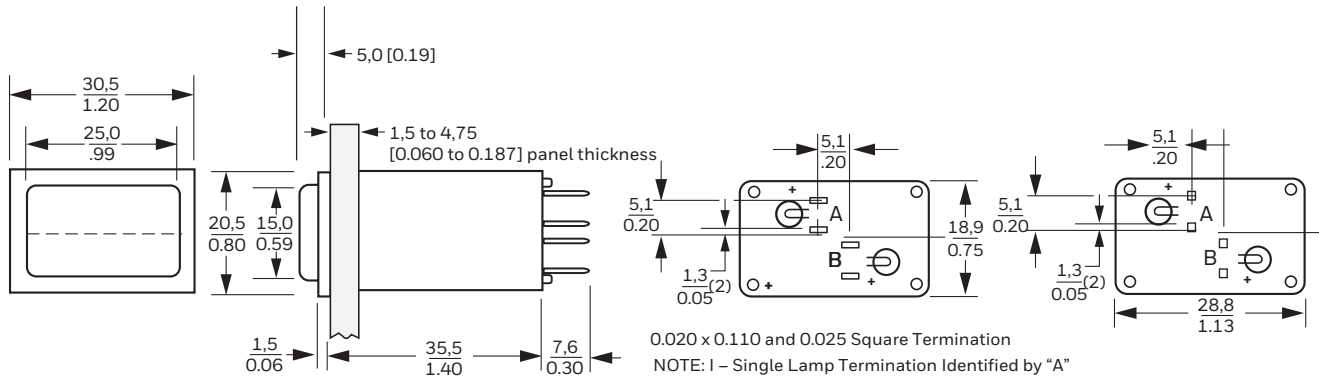
\*When projected color is white, white cap is furnished with clear insert

\*\*For AML51 Series Buttons Style C, D, F or G with Legends refer to Figure 52

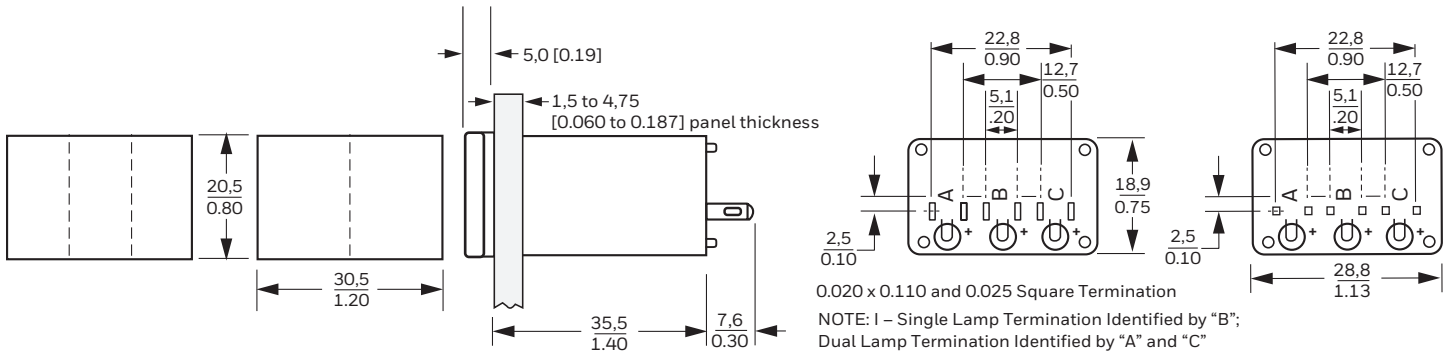
Figure 44. AML41 Series Dimensions, mm [in] or mm/in



**AML41 Series Square, pushbutton style**

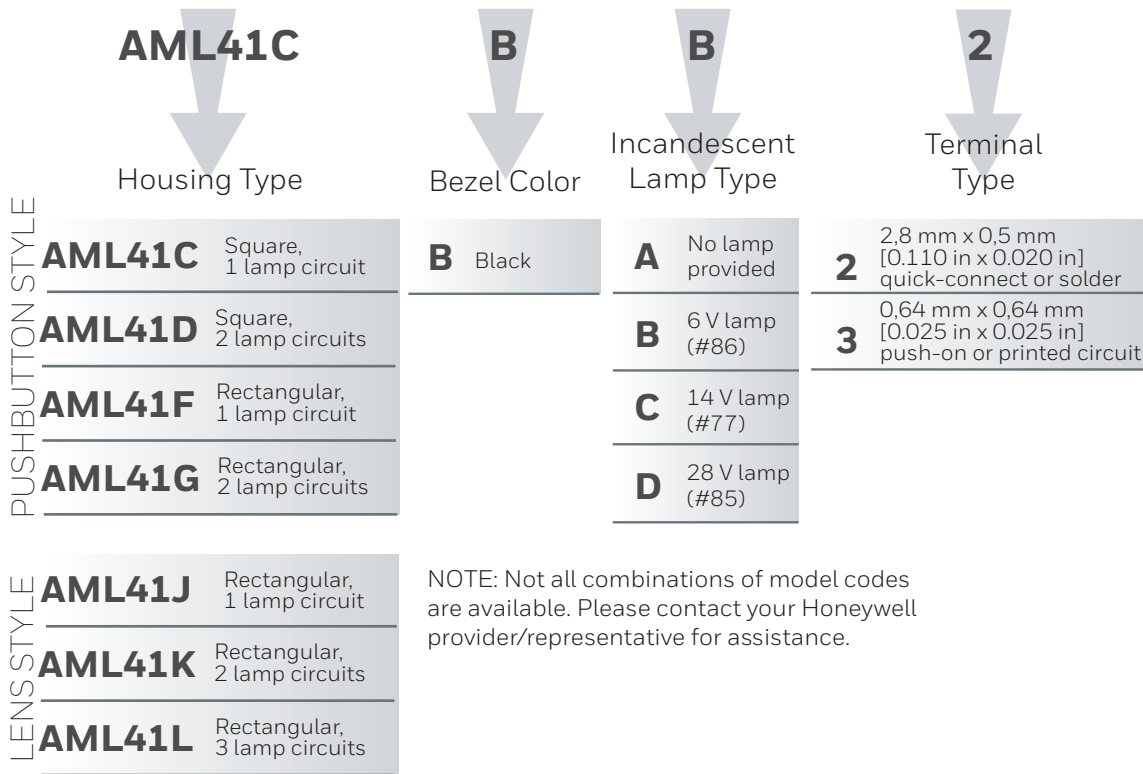


**AML41 Series Rectangular, pushbutton style**



**AML41 Series Rectangular, lens style**

**Figure 45. AML41 Series Nomenclature**



**Figure 46. AML51 Buttons for AML21 Switches, AML31 Switches and AML41 Indicators Nomenclature**

For incandescent lighted or unlighted pushbuttons and indicators with pushbutton style displays

		<b>AML51-C</b>	<b>11</b>	<b>R</b>	
		Pushbutton Style Cap Housing	Display Type	Full Color or 1 <sup>st</sup> Color Split	2 <sup>nd</sup> Color Split (if required)
<b>SQUARE</b>	<b>AML51-C</b>	0.19 inch button height	<b>10</b> Transmitted color, one-piece color cap (no legend)	<b>R</b> Red	<b>R</b> Red
	<b>AML51-A</b>	0.32 inch button height	<b>20</b> Transmitted color, one-piece color cap (legend on cap)	<b>Y</b> Yellow	<b>Y</b> Yellow
	<b>AML51-B*</b>	0.43 inch button height	<b>11</b> Transmitted color, clear cap with color insert (no legend)	<b>G</b> Green	<b>G</b> Green
	<b>AML51-D</b>	0.19 inch button height with split for AML41 two lamp indicator	<b>21</b> Transmitted color, clear cap with color insert (Legend on insert)	<b>B</b> Blue	<b>B</b> Blue
	<b>AML51-F</b>	0.19 inch button height	<b>30</b> Dead front (smoke gray cap with color insert)	<b>W</b> *** White	<b>W</b> *** White
<b>RECTANGULAR</b>	<b>AML51-H</b>	0.32 inch button height	<b>50</b> ***Projected color (white cap and color insert)	<b>K</b> Black	<b>K</b> Black
	<b>AML51-E*</b>	0.43 inch button height		<b>L</b> Gray	<b>L</b> Gray
	<b>AML51-G</b>	0.19 inch button height for 2 lamps - split along long axis		<b>A</b> **** Amber	<b>A</b> **** Amber
	<b>AML51-N**</b>	0.32 inch button height for 2 lamps - split along long axis			

NOTE: Not all combinations of model codes are available.  
 Please contact your Honeywell provider/representative for assistance  
 Note: Dimensions include the 0.06 inch standard bezel  
 Note: Black and gray buttons not recommended for lighted displays  
 \*Available with transmitted color (10) only  
 \*\*Not available with transmitted color (10)  
 \*\*\*Insert is clear when display type (50) is specified with white(W) color  
 \*\*\*\*Available with display type "transmitted color" and "dead front" only

**Figure 47. AML51 Lens for AML41 Indicators with Lens Cap Style Nomenclature**

For incandescent indicators with lens-style cap

<b>AML51-K</b>		<b>11</b>	<b>R</b>		
Lens Style Cap (for indicators only)		Display Type	Full Color or 1 <sup>st</sup> Color Split	2 <sup>nd</sup> Color Split (if required)	3 <sup>rd</sup> Color Split (if required)
<b>AML51-J</b>	0.2 in cap height for 1 lamp indicators	<b>10</b>	<b>R</b> Red	<b>R</b> Red	<b>R</b> Red
<b>AML51-K</b>	0.2 in cap height for 2 lamp indicators (split along short axis)	<b>11</b>	<b>Y</b> Yellow	<b>Y</b> Yellow	<b>Y</b> Yellow
<b>AML51-L</b>	0.2 in cap height for 3 lamp indicators (split along short axis)	<b>30</b>	<b>G</b> Green	<b>G</b> Green	<b>G</b> Green
		<b>50</b>	<b>B</b> Blue	<b>B</b> Blue	<b>B</b> Blue
			<b>W</b> * White	<b>W</b> * White	<b>W</b> * White
			<b>A</b> ** Amber	<b>A</b> ** Amber	<b>A</b> ** Amber

NOTE: Not all combinations of model codes are available.  
 Please contact your Honeywell provider/representative for assistance  
 \*Insert is clear when display type (50) is specified with white (W) color  
 \*\*Available with display type "transmitted color" and "dead front" only

**Indicator with integral LED**

(see Table 43)



**Button** (see Table 44)



**Complete Unit**



**or compact indicator with LED display**

(see Table 43)



**Table 43. AML42 Series Indicators with Integral LED and 0.110 x 0.020 quick connect or solder terminals**

Supply Voltage (dc)	LED Color	Square Housing 1 LED lamp circuit	Rectangular Compact Housing: 1 LED lamp circuit	Rectangular Compact Housing: 1 LED lamp circuit with diode protection**
		AML42C Series requires AML52-A or AML52-C series button ordered separately from table below	AML42S Series with integral lens	AML42S Series with integral lens
V*	Red	-	AML42SBB2	-
V*	Yellow	-	AML42SBH2	-
V*	Gtreen	-	AML42SBR2	-
5	Red	AML42CBC8**	AML42SBC2	AML42SBC8
5	Yellow	-	AML42SBJ2	-
5	Green	AML42CBS2	AML42SBS2	AML42SBS8
15	Red	-	AML42SBE2	-
15	Yellow	-	AML42SBL2	AML42SBL8
15	Green	-	AML42SBW2	-
24	Red	-	AML42SBF2	-
24	Yellow	AML42CBM2	AML42SBM2	AML42SBM8
24	Green	-	AML42SBX2	AML42SBX8

\*The LED does not include an internal resistor. A suitable external resistor must be added to the LED circuit for a nominal current of 20 mA

\*\*Catalog listing includes diode protection. Reference Table 48.

**Table 44. AML52 Series Buttons without Legends for AML42C Series LED Indicators**

Button Color	AML52-C Series (Standard)	AML52-A Series (Optional)
<b>One piece button</b>		
Red	AML52-C10R	AML52-A10R
Yellow	AML52-C10Y	AML52-A10Y
Green	AML52-C10G	AML52-A10G
Blue	AML52-C10B	AML52-A10B
White	AML52-C10W	AML52-A10W
Black	AML52-C10K	AML52-A10K
Gray	AML52-C10L	-

Figure 48. AML42 Series Dimensions, mm [in] or mm/in

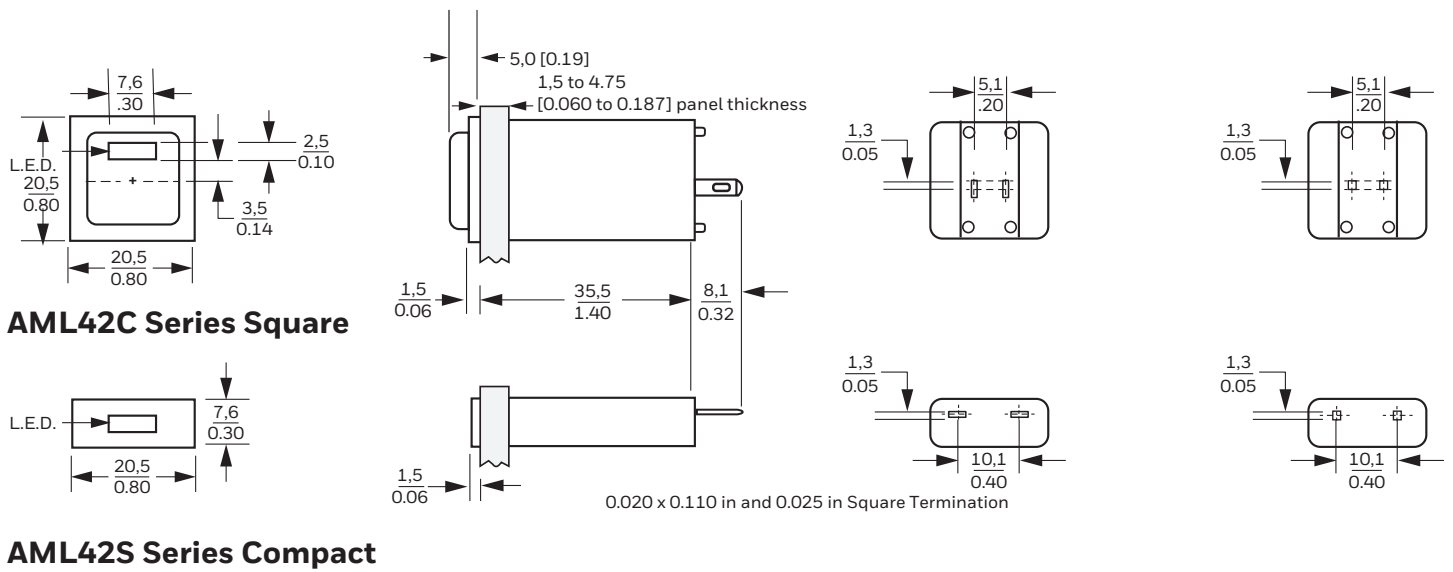


Figure 49. AML42 Series Nomenclature

INDICATOR		AML42		INTEGRAL LED		
AML42C		B	B	2		
Housing (Standard Bezel)		Bezel Color		LED Color & Voltage		Terminal Type
<b>AML42C</b>	Square, 1 LED lamp circuit	<b>B</b> Black	<b>B</b>	Vdc*	<b>2</b>	2,8 mm x 0,5 mm [0.110 in x 0.020 in] Quick-connect or Solder
<b>AML42S</b>	Compact, 1 LED lamp circuit		<b>C</b>	5 Vdc	<b>3</b>	0,64 mm x 0,64 mm [0.025 in x 0.025 in] Push-on or Printed Ckt.
<p>NOTE: Not all combinations of model codes are available. Please contact your Honeywell provider/representative for assistance</p> <p>* An appropriate external series resistor must be added to the LED circuit to limit the current to a nominal 20 mA</p>		RED	<b>D</b>	10 Vdc	<b>8</b>	2,8 mm x 0,5 mm [0.110 x 0.020 in] Quick-connect or solder w/ diode protection
			<b>E</b>	15 Vdc	<b>9</b>	0,64 mm x 0,64 mm [0.025 in x 0.025 in] push-on or printed circuit with diode protection
			<b>F</b>	24 Vdc		
			<b>H</b>	Vdc*		
			<b>J</b>	5 Vdc		
		YELLOW	<b>K</b>	10 Vdc		
			<b>L</b>	15 Vdc		
			<b>M</b>	24 Vdc		
		GREEN	<b>R</b>	Vdc*		
			<b>S</b>	5 Vdc		
<b>T</b>	10 Vdc					
<b>W</b>	15 Vdc					
			<b>X</b>	24 Vdc		



**Figure 50. AML52 Buttons for AML42C Indicators Switches Nomenclature**

<b>AML52-C</b> Pushbutton Style Cap Square Housing		<b>10</b> Display Type	<b>R</b> Button Color
<b>AML52-C</b>	0.19 inch button height	<b>10</b> Transmitted color, one-piece color cap (no legend)	<b>R</b> Red
<b>AML52-A</b>	0.32 inch button height		<b>Y</b> Yellow
			<b>G</b> Green
			<b>B</b> Blue
			<b>W</b> White
			<b>K</b> Black
			<b>L</b> Gray
			<b>A</b> Amber

NOTE: Not all combinations of model codes are available. Please contact your Honeywell provider/representative for assistance.

**Table 45. AML45 Series LED Annunciators with 0.110 x 0.020 quick connect or solder terminals**

Supply Voltage (dc)	LED Color	Rectangular Housing Full Screen 2 LEDs	Rectangular Housing Full Screen 2 LEDs with diode protection**	Rectangular Housing Split Screen 2 LEDs
5	Red	AML45RKB2RR	-	-
5	Yellow	AML45RKB2YY	-	-
5	Green	-	-	-
15	Red	AML45RKD2RR	-	-
15	Yellow	-	-	-
15	Green	-	-	-
24	Red	AML45RKF2RR	AML45RKF8RR	AML45SKF8RR
24	Yellow	AML45RKF2YY	AML45RKF8YY	-
24	Green	AML45RKF2GG	AML45RKF2GG	-

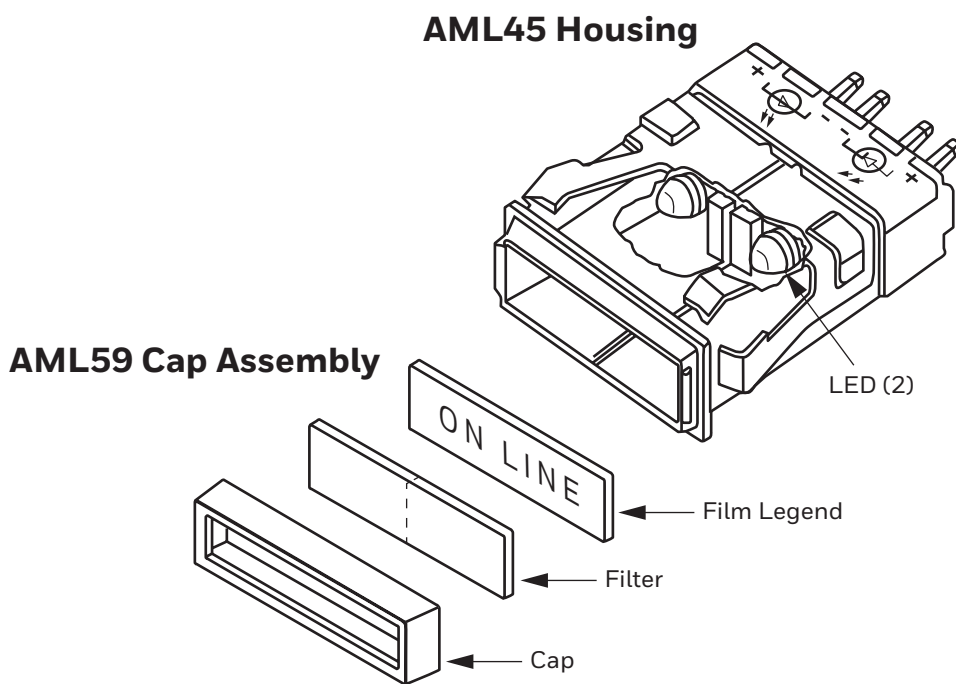
**Table 46. AML59 Series Lens Cap Assemblies without Legend Insert for AML45 Series Annunciators\***

Full Screen Insert Color	Catalog Listing
Red	AML59-RK10R
Yellow	AML59-RK10Y
Green	AML59-RK10G

\*For AML59 Series Legend Film Insert with legend, contact the local Honeywell source

\*\* Reference Table 48 for information

## Solid State LED Annunciators



**Figure 51. AML45 Series Annunciators Dimensional Drawing, mm [in] or mm/in**

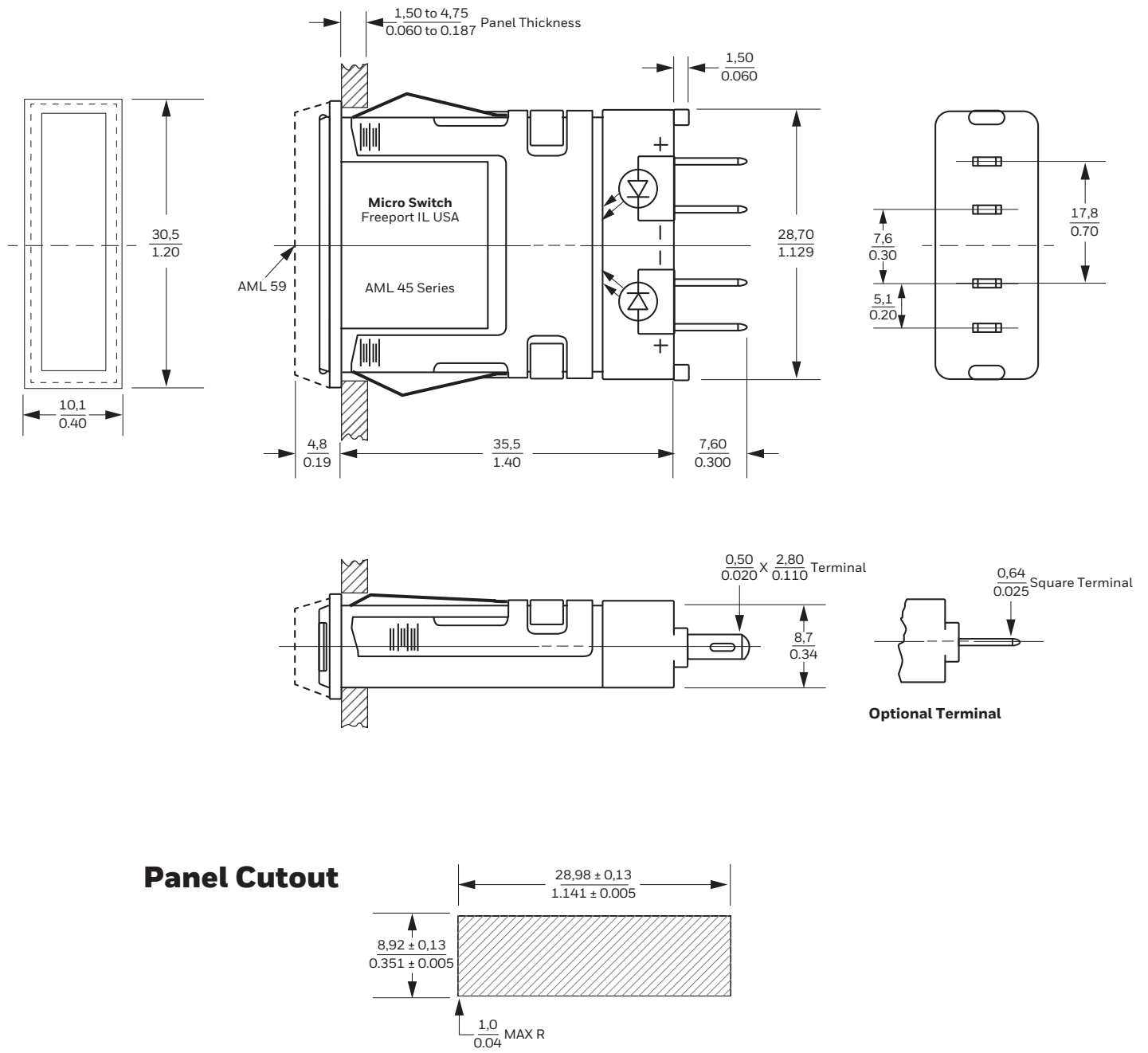


Figure 52. AML Pushbutton Legend Sheet

# AML Pushbutton Legend Sheet/Product Specification

Page \_\_\_\_\_ of \_\_\_\_\_

## LEGEND ORDER GUIDE

Button: Type Orientation	Figure NO	Max Lines/Area				Max Characters/Line				
		5/64	7/64	9/64	13/64	5/16	7/64	9/64	13/64	5/16
1 A*B P,R	1	4 *3	3 *2	3 *2	1 *1	7 *5	5 *4	5 *3	3 *2	1 *1
1 C	2	4 3	3 2	3 2	1 1	7 5	5 4	5 3	3 2	1 1
1 2 D	3	1 1	1 1	1 0	0 0	7 5	5 4	5 3	0 0	0 0
1 E,H*	4	4 *3	3 *2	3 *2	1 *1	11 *10	9 *8	8 *7	5 *5	3 *3
1 E,H*	5	6 *6	4 *4	4 *4	3 *2	7 *5	5 *4	5 *3	3 *2	1 *1
1 F	6	4 3	3 2	3 2	1 1	11 9	8 7	8 7	5 5	3 3
1 F	7	6 6	4 4	4 4	3 2	7 5	5 4	5 3	3 2	1 1
1 2 G,N	8	1 1	1 1	1 0	0 0	11 10	9 8	8 7	0 0	0 0
1 M	9	5 0	4 0	3 0	2 0	8 0	6 0	6 0	3 0	1 0

### Definitions of Markings

- Thru holes to snap into indicator housings
- Internal reliefs to snap over switch plunger tabs

### Standard Legend Placement

- Use special legends sec. for other placements
- Transmitted Color - Legend on outer shell (Button)
- Dead Front - Legend on Insert
- Projected Color - Legend on outer shell (Button)
- Transmitted color with clear cap legend on Insert

### LEGEND ORDER CHART

Customer Part No	Fig No	Type Size				Ink Color		But-ton Qty	1st Line	2nd Line	3rd Line	4th Line	5th Line	6th Line
		5/64	7/64	9/64	13/64	5/16	White							
								1						
								2						
								1						
								2						
								1						
								2						
								1						
								2						

Catalog Listing  
**AML51 -**

Customer PO. No. \_\_\_\_\_ Customer Dwg. No. \_\_\_\_\_

Honeywell Sales Order \_\_\_\_\_ Line Number \_\_\_\_\_ Schedule No. \_\_\_\_\_

Customer: \_\_\_\_\_

Address: \_\_\_\_\_ (city) \_\_\_\_\_ (state) \_\_\_\_\_

### Instructions

- Fill in appropriate catalog listing - one listing/sheet.
- Check proper figure #: Type size, Type color.
- Fill in quantity required.
- Indicate legends desired - Do not exceed maximums shown in legend order guide.

### Note

- For proper legend orientation, AML housings (when viewed from front of panel) should have "MICRO SWITCH" logo oriented "Up" on square devices and "Up" or the "LEFT" on rectangular devices.
- Please use black ink in filling out this form to help us process your order.
- \* INSERT ONLY ON STYLE A & H BUTTON.

Modified Gothic lettering (A thru Z), numerals (0 thru 9) and Symbols below available in 5/64, 7/64, 9/64, 13/64 and 5/16.

**A3** Modified Gothic

STANDARD SYMBOLS AVAILABLE

-	,	:	;	!	?	'	"	'	-	/	(	)	*	&
\$	¢	#	%	o	+	-	±	÷	X	=	≠	>	<	
→	↑	↓	←	Cr	1/4	1/2	3/4	1/3	2/3	@	∞			

**SPECIAL LEGENDS**

NOTE: Use this area to show special Legend Locations or Configurations NOT shown to the left. NON-STANDARD legends will involve additional charges and increased delivery time.

Fig. "A" \_\_\_\_\_ Fig. "B" \_\_\_\_\_

Sheet prepared by: \_\_\_\_\_

(Signature) \_\_\_\_\_

(Date) \_\_\_\_\_

Table 47. AMLSeries Accessories

	Catalog Listing	Type	Description	Note
	AML71SCB <sup>1</sup>	Center	Short barrier for use with square devices or short side of rectangular devices	-
	AML71SEB <sup>1</sup>	End		-
	AML71LCB <sup>1</sup>	Center	Long barrier for use with long side of rectangular devices	-
	AML71LEB <sup>1</sup>	End		-
	AML75ABC	Std. bezel	Pushbutton panel seal for lighted or unlighted square pushbutton 0.19 in high	Operating temperature, 0 °C to 55 °C [32 °F to 131 °F]
	AML75BBC	Std. bezel	Pushbutton panel seal for lighted or unlighted rectangular pushbutton 0.19 in high	Operating temperature, 0 °C to 55 °C [32 °F to 131 °F]
	AML76C10T01P	Std. bezel	Clear switch guard cover for square 0.19 in height pushbuttons	May be locked with 0.020 wire for additional protection
	AML76F10T01P	Std. bezel	Clear switch guard cover for rectangular 0.19 in height pushbuttons	May be locked with 0.020 wire for additional protection
	AML78CB	Std. bezel	Square panel plug, black matte finish	Same height as the "Std" bezel
	AML78FB	Std. bezel	Rectangular panel plug, black matte finish	Same height as the "Std" bezel
	AML91LA86	-	6.3 V incandescent T-1 3/4 wedge base lamp	#86 Lamp
	AML91LA73	-	14 V incandescent T-1 3/4 wedge base lamp	#73 Lamp
	AML91LA85	-	28 V incandescent T-1 3/4 wedge base lamp	#85 Lamp
	AML92ERL	Six chip	Red LED, T-1 3/4 wedge base lamp High intensity	*Requires external series current limiting resistor
	AML92EGL	Six chip	Green LED, T-1 3/4 wedge base lamp High intensity	*Requires external series current limiting resistor
	AML92EYL	Six chip	Yellow LED, T-1 3/4 wedge base lamp High intensity	*Requires external series current limiting resistor
	AML92EWL	Six chip	White LED, T-1 3/4 wedge base lamp High intensity	*Requires external series current limiting resistor

\*The LED did not include an internal resistor. A suitable external resistor must be added to the LED circuit limiting the current to 50 mA

<sup>1</sup>Barriers are designed to prevent inadvertent actuation of adjacent mounted switches.

**Table 48. Integral LEDs**

LEDs Furnished Permanently Installed in These Products	V <sub>1</sub>	I <sub>1</sub>	V <sub>PD</sub>	Peak Inverse Voltage	
				Without Diode Protection	With Diode Protection
AML 22, 25, 26, 42	2.4V	20mA	0.7V	5V	34V
AML45	2.4V	20mA	0.7V	4V	33V

100,000 hours (half life)

**AML92 SERIES LEDs**

For use with these AML switches and indicators equipped with lamp sockets:

- **Pushbuttons switches:** AML21 rectangular and square, and AML31
- **Paddle switches:** AML23/33
- **Rocker Switches:** AML 24/34
- **Indicators:** AML41

**Table 49. AML92 Operating Characteristics**

Type	V <sub>F</sub> Forward Voltage (typ.)				I <sub>F</sub> Forward Current	V <sub>R</sub> Reverse Voltage
	Yellow	Green	Red	White		
Six chip	4 V	4 V	4 V	4 V	50 mA	5.6 V

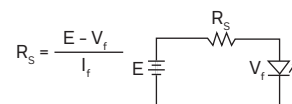
Operating Temperature Range: -20 °C to 60 °C [-4 °F to 140 °F]

Storage Temperature Range: -30 °C to 100 °C [-22 °F to 212 °F]

**LED Application Information**

For those devices without internal current limiting resistors, suitable external control of the LED current must be provided. It is recommended that a minimum of 5 Vdc open circuit voltage with an appropriate series resistance be used to drive LED devices. This minimizes the effect of temperature (current variation) on forward voltage of the LED.

Resistor values can be determined by supply voltage or current for LED:



Where: R<sub>s</sub> = Series Resistance

E = Supply Voltage

V<sub>f</sub> = Forward Voltage of LED

I<sub>f</sub> = Circuit Current

If a diode is added in series for reverse polarity protection, then:

$$R_s = \frac{E - V_f - V_{PD}}{I_f}$$

Where: V<sub>PD</sub> = Forward Voltage of Protection Diode

**⚠ WARNING  
PERSONAL INJURY**

DO NOT USE these products as safety or emergency stop devices or in any other application where failure of the product could result in personal injury.

**Failure to comply with these instructions could result in death or serious injury.**

**⚠ WARNING  
MISUSE OF DOCUMENTATION**

- The information presented in this product sheet is for reference only. Do not use this document as a product installation guide.
- Complete installation, operation, and maintenance information is provided in the instructions supplied with each product.

**Failure to comply with these instructions could result in death or serious injury.**

**Warranty/Remedy**

Honeywell warrants goods of its manufacture as being free of defective materials and faulty workmanship during the applicable warranty period. Honeywell's standard product warranty applies unless agreed to otherwise by Honeywell in writing; please refer to your order acknowledgment or consult your local sales office for specific warranty details. If warranted goods are returned to Honeywell during the period of coverage, Honeywell will repair or replace, at its option, without charge those items that Honeywell, in its sole discretion, finds defective. **The foregoing is buyer's sole remedy and is in lieu of all other warranties, expressed or implied, including those of merchantability and fitness for a particular purpose. In no event shall Honeywell be liable for consequential, special, or indirect damages.**

While Honeywell may provide application assistance personally, through our literature and the Honeywell web site, it is buyer's sole responsibility to determine the suitability of the product in the application.

Specifications may change without notice. The information we supply is believed to be accurate and reliable as of this writing. However, Honeywell assumes no responsibility for its use.

**For more information**

Honeywell Advanced Sensing Technologies services its customers through a worldwide network of sales offices and distributors. For application assistance, current specifications, pricing or the nearest Authorized Distributor, visit [sensing.honeywell.com](http://sensing.honeywell.com) or call:

International +815 618 3231

USA/Canada +302 613 4491

**Honeywell  
Advanced Sensing Technologies**

830 East Arapaho Road  
Richardson, TX 75081  
[sps.honeywell.com/ast](http://sps.honeywell.com/ast)