

REV.	EN. NO.	DESCRIPTION	SIGN	DATE
C1	N/A	INITIAL DRAWING	Liu	2019/08/13

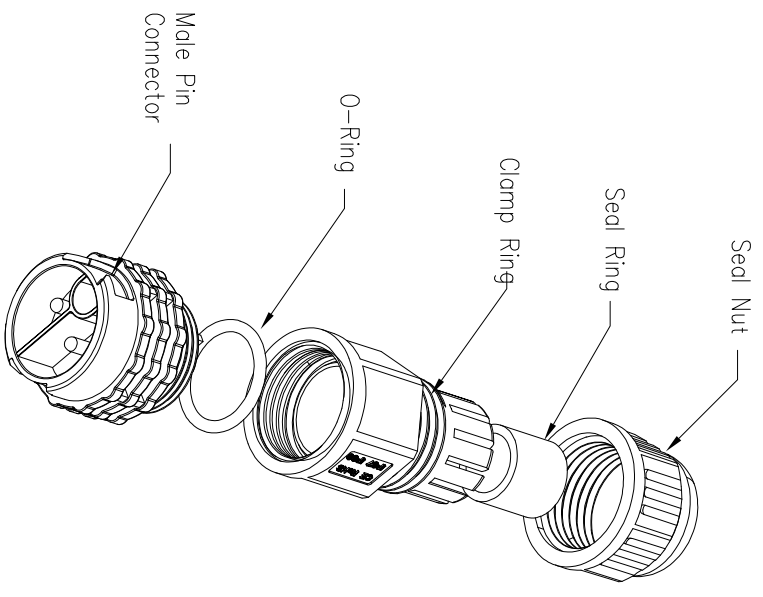

24XXX331-XX Cable Range OD
 01 OD: $\phi 3.5\text{mm} \sim \phi 6.8\text{mm}$
 02 OD: $\phi 6.8\text{mm} \sim \phi 10.5\text{mm}$
 Pin Number

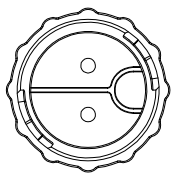
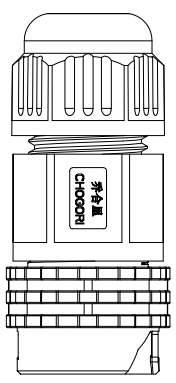
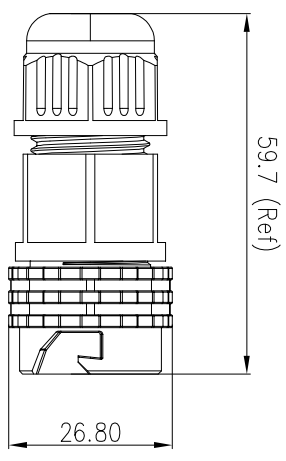
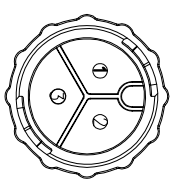
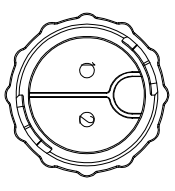

2 Pin
 P/N: 24002331-02

3 Pin
 P/N: 24003331-02

Pin Assignments Front View

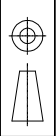

UNIT: mm
 TOLERANCE
 .X ±0.25
 .XX ±0.15
 .XXX ±0.05
 ANGLES ±1°

DESCRIPTION
 Large Series Push Lock
 Female Plug With Male Pin

SCALE: 1:1
 REV: C1
 SIZE: A4
 SHEET: 1 OF 1
 * : Inspection Item

CHOGORI

- Specification:
1. Operation Temperature: $-45^{\circ}\text{C} \sim 105^{\circ}\text{C}$.
 2. Insulation Resistance: $100\text{M}\Omega$ at DC500V.
 3. Contact Resistance: $<10\text{m}\Omega$.
 4. Withstand Voltage: 2000V AC
 5. Operating Current: 20A
 6. Operating Voltage: AC 300V
 7. Waterproof Rate: IP67 (Mated)
 8. Seal Nut: Nylon, Black
 9. Seal Ring: Silicon, Black.
 10. Clamp Ring: Nylon, Black
 11. O-Ring: Silicon, Red
 12. Male Pin: Copper Alloy, Gold Plated
 13. Connector: Nylon+GF, Black
 14. RoHS Compliant.
 15. UL Compliant.
 16. Mating Cap: 806-00068-00

PART NO	24XXX331-XX	DRAWN BY	Liu	DATE	2019/08/13
DWG NO		CHECKED BY	Mo	DATE	2019/08/13
CUSTOMER		APPROVED BY	Panson	DATE	2019/08/13