



<b>Title</b>	<i>Reference Design Report for a 150 W Power Factor Corrected LLC Power Supply Using HiperPFS™ -2 (PFS7326H) and HiperLCS™ (LCS702HG)</i>
<b>Specification</b>	90 VAC – 265 VAC Input; 150 W (~43 V at 0 - 3.5 A) Output (Constant Current)
<b>Application</b>	LED Streetlight
<b>Author</b>	Applications Engineering Department
<b>Document Number</b>	RDR-382
<b>Date</b>	June 28, 2017
<b>Revision</b>	6.5

#### **Summary and Features**

- Integrated PFC and LLC stages for a very low component count design
- Continuous mode PFC using low cost ferrite core
- High frequency (250 kHz) LLC for extremely small transformer size.
- >95% full load PFC efficiency at 115 VAC
- >95% full load LLC efficiency
  - System efficiency 91% / 93% at 115 VAC / 230 VAC
- Start-up circuit eliminates the need for a separate bias supply
- On-board current regulation and analog dimming

#### **PATENT INFORMATION**

The products and applications illustrated herein (including transformer construction and circuits external to the products) may be covered by one or more U.S. and foreign patents, or potentially by pending U.S. and foreign patent applications assigned to Power Integrations. A complete list of Power Integrations' patents may be found at [www.powerint.com](http://www.powerint.com). Power Integrations grants its customers a license under certain patent rights as set forth at <http://www.powerint.com/ip.htm>.

---

#### **Power Integrations**

5245 Hellyer Avenue, San Jose, CA 95138 USA.  
Tel: +1 408 414 9200 Fax: +1 408 414 9201  
[www.power.com](http://www.power.com)

## Table of Contents

1	Introduction .....	5
2	Power Supply Specification .....	7
3	Schematic .....	8
4	Circuit Description .....	10
4.1	Input Filter / Boost Converter / Bias Supply .....	10
4.2	EMI Filtering / Inrush Limiting .....	10
4.3	Main PFC Stage .....	10
4.4	Primary Bias Supply / Start-up .....	10
4.5	LLC Converter .....	11
4.6	Primary.....	11
4.7	Output Rectification .....	13
4.8	Output Current and Voltage Control .....	13
5	PCB Layout.....	15
6	Bill of Materials .....	17
7	LED Panel Characterization .....	20
7.1	LED Panel Current Sharing .....	21
7.2	Constant Voltage Load .....	22
8	Magnetics.....	26
8.1	PFC Choke (L2) Specification .....	26
8.1.1	Electrical Diagram .....	26
8.1.2	Electrical Specifications.....	26
8.1.3	Materials .....	26
8.1.4	Build Diagram.....	27
8.1.5	Winding Instructions .....	27
8.1.6	Winding Illustrations .....	28
8.2	LLC Transformer (T1) Specification .....	31
8.2.1	Electrical Diagram .....	31
8.2.2	Electrical Specifications.....	31
8.2.3	Materials .....	31
8.2.4	Build Diagram.....	32
8.2.5	Winding Instructions .....	32
8.2.6	Winding Illustrations .....	33
8.3	Output Inductor (L3) Specification .....	37
8.3.1	Electrical Diagram .....	37
8.3.2	Electrical Specifications.....	37
8.3.3	Material List.....	37
8.3.4	Construction Details .....	37
9	PFC Design Spreadsheet.....	38
10	LLC Transformer Design Spreadsheet .....	42
11	Heat Sinks.....	47
11.1	Primary Heat Sink.....	47
11.1.1	Primary Heat Sink Sheet Metal .....	47



11.1.2	Primary Heat Sink with Fasteners .....	48
11.1.3	Primary Heat Sink Assembly .....	49
11.2	Secondary Heat Sink .....	50
11.2.1	Secondary Heat Sink Sheet Metal .....	50
11.2.2	Secondary Heat Sink with Fasteners .....	51
11.2.3	Secondary Heat Sink Assembly .....	52
12	RD-382 Performance Data .....	53
12.1	LLC Stage Efficiency .....	53
12.2	Total Efficiency .....	54
12.3	Power Factor .....	55
12.4	Harmonic Distribution .....	56
12.5	THD, 100% Load .....	56
12.6	Output Current vs. Dimming Input Voltage .....	57
13	Waveforms .....	58
13.1	Input Current, 100% Load .....	58
13.2	LLC Primary Voltage and Current .....	59
13.3	Output Rectifier Peak Reverse Voltage .....	60
13.4	PFC Inductor + Switch Voltage and Current, 100% Load .....	61
13.5	AC Input Current and PFC Output Voltage during Start-up .....	62
13.6	LLC Start-up Output Voltage and Transformer Primary Current Using LED Output Load .....	62
13.7	Output Voltage / Current Start-up Using LED Load .....	63
13.8	LLC Output Short-Circuit .....	64
13.9	Output Ripple Measurements .....	65
13.9.1	Ripple Measurement Technique .....	65
13.9.2	Ripple Measurements .....	66
14	Temperature Profiles .....	67
14.1	90 VAC, 60 Hz, 150 W Output, Room Temperature .....	67
14.2	115 VAC, 60 Hz, 150 W Output, Room Temperature .....	70
14.3	230 VAC, 50 Hz, 150 W Output, Room Temperature .....	73
15	Output Gain-Phase .....	76
16	Conducted EMI .....	77
17	Line Surge Testing .....	79
17.1	Line Surge Test Set-up .....	79
17.2	Differential Mode Surge, 1.2 / 50 $\mu$ sec .....	80
17.3	Common Mode Surge, 1.2 / 50 $\mu$ sec .....	80
18	Revision History .....	81

**Important Notes:**

Although this board is designed to satisfy safety isolation requirements, the engineering prototype has not been agency approved. All testing should be performed using an isolation transformer to provide the AC input to the prototype board.

Since there is no separate bias converter in this design, ~280 VDC is present on bulk capacitor C14 immediately after the supply is powered down. For safety, this capacitor must be discharged with an appropriate resistor (10 k / 2 W is adequate), or the supply must be allowed to stand ~10 minutes before handling.



## 1 Introduction

This engineering report describes a 43 (nominal) V, 150 W reference design for a power supply for 90-265 VAC LED street lights and other high power lighting applications. The power supply is designed with a constant current output in order to directly drive a 150 W LED panel at 43 V.

The design is based on the PFS7326H for the PFC front-end and a LCS702HG for the LLC output stage.

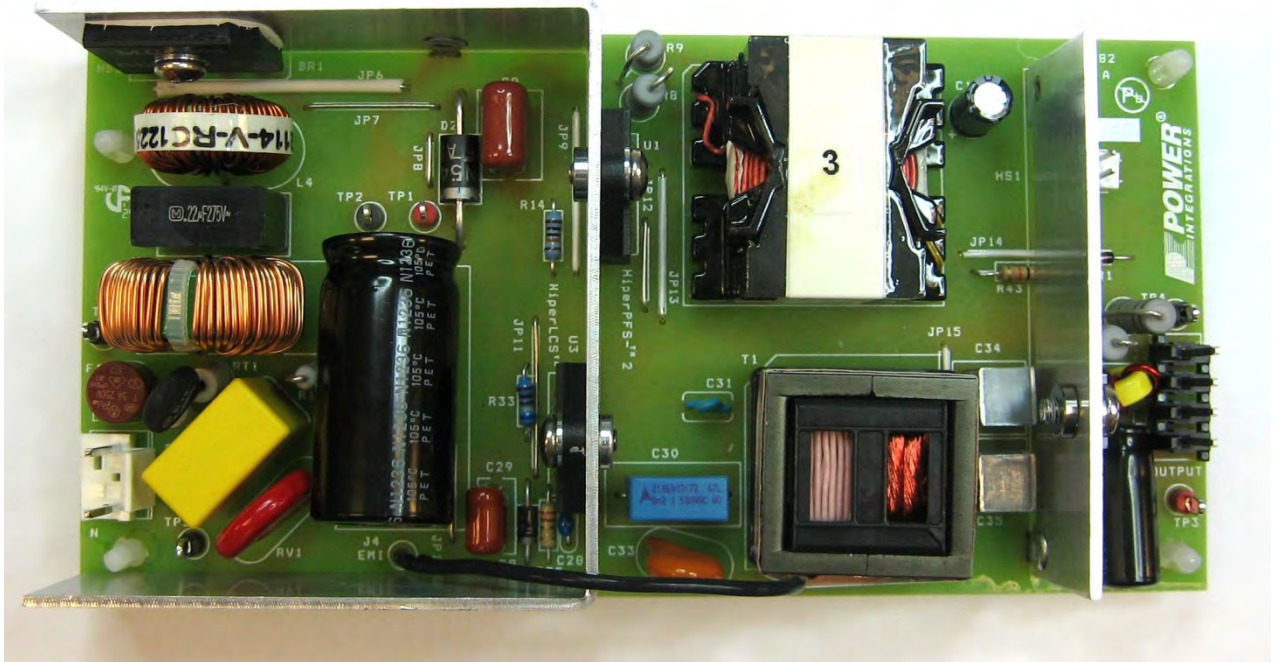


Figure 1 – RD-382 Photograph, Top View.

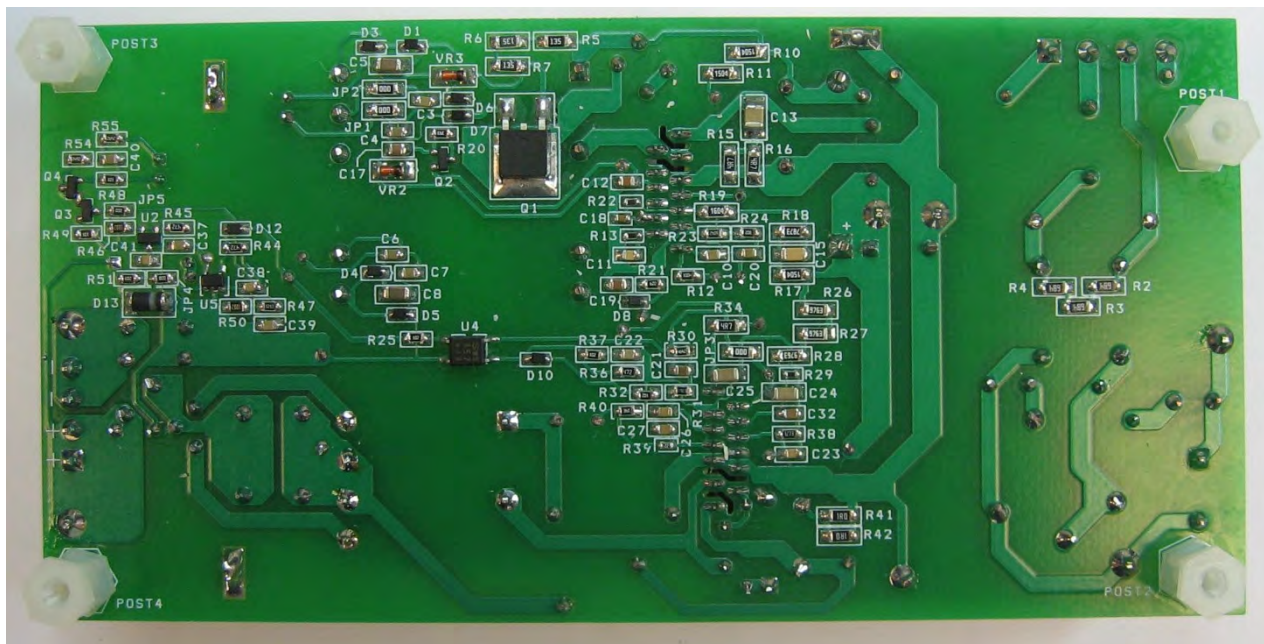


Figure 2 – RD-382 Photograph, Bottom View.

## 2 Power Supply Specification

The table below represents the minimum acceptable performance for the design. Actual performance is listed in the results section.

Description	Symbol	Min	Typ	Max	Units	Comment
<b>Input</b>						
Voltage	$V_{IN}$	90		265	VAC	3 Wire input.
Frequency	$f_{LINE}$	47	50/60	64	Hz	
Power Factor	PF	0.97				Full load, 230 VAC
<b>Main Converter Output</b>						
Output Voltage	$V_{LG}$		43		V	43 VDC (nominal - defined by LED load)
Output Ripple	$V_{RIPPLE(LG)}$			300	mV P-P	20 MHz bandwidth
Output Current	$I_{LG}$	0.00	3.5		A	Constant Current Supply protected for no-load condition
<b>Total Output Power</b>						
Continuous Output Power	$P_{OUT}$		150		W	
Peak Output Power	$P_{OUT(PK)}$			N/A	W	
<b>Efficiency</b>						
Total system at Full Load	$\eta_{Main}$		91 93		%	Measured at 115 VAC, Full Load Measured at 230 VAC, Full Load
<b>Environmental</b>						
Conducted EMI						Meets CISPR22B / EN55022B
Safety						Designed to meet IEC950 / UL1950 Class II
Surge						1.2/50 $\mu$ s surge, IEC 1000-4-5,
Differential		2			kV	Differential Mode: 2 $\Omega$
Common Mode		4			kV	Common Mode: 12 $\Omega$
Ambient Temperature	$T_{AMB}$	0		60	$^{\circ}$ C	See thermal section for conditions

### 3 Schematic

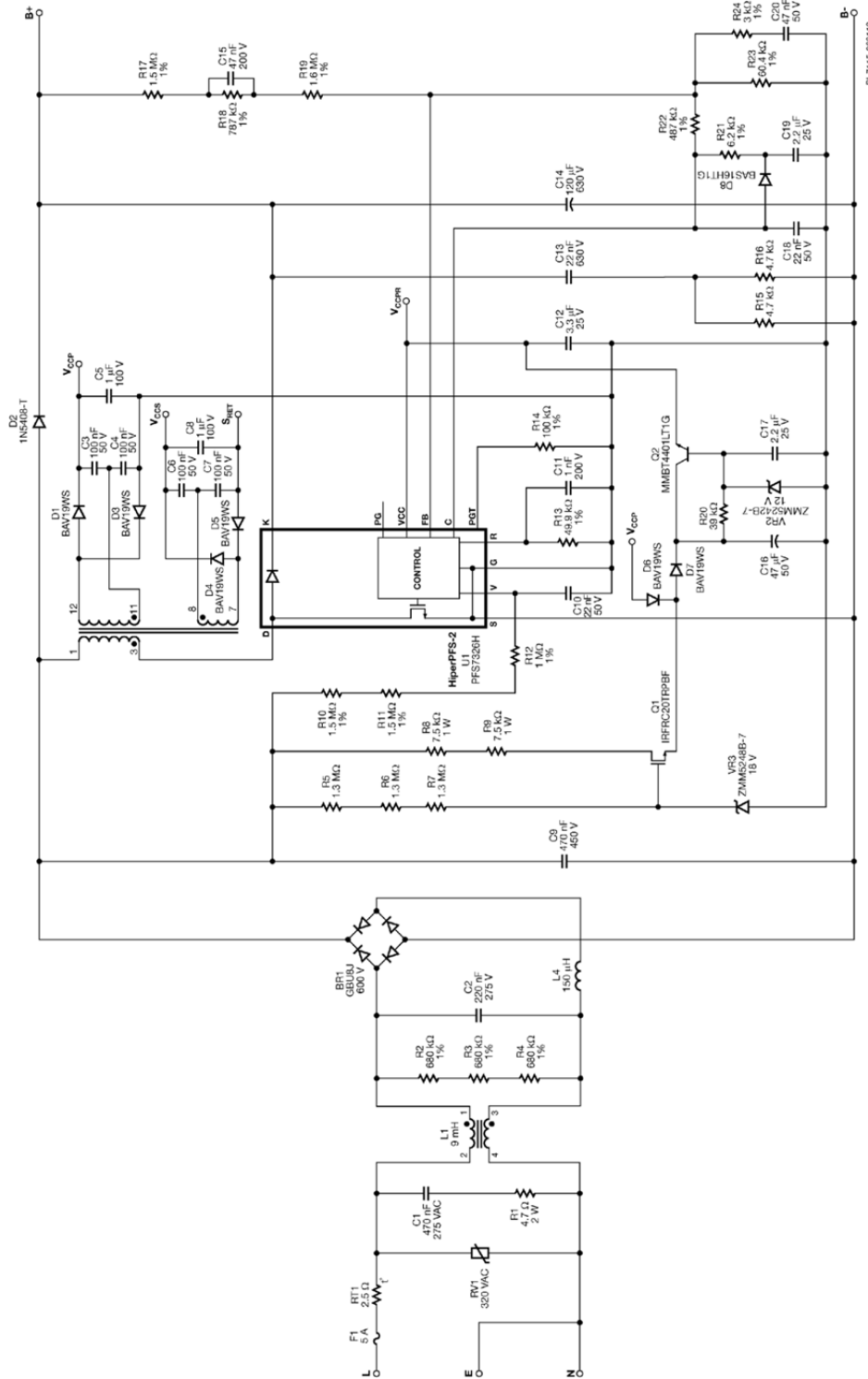


Figure 3 – Schematic RD-382 Street Light Power Supply Application Circuit - Input Filter, PFC Power Stage, and Bias Supplies.





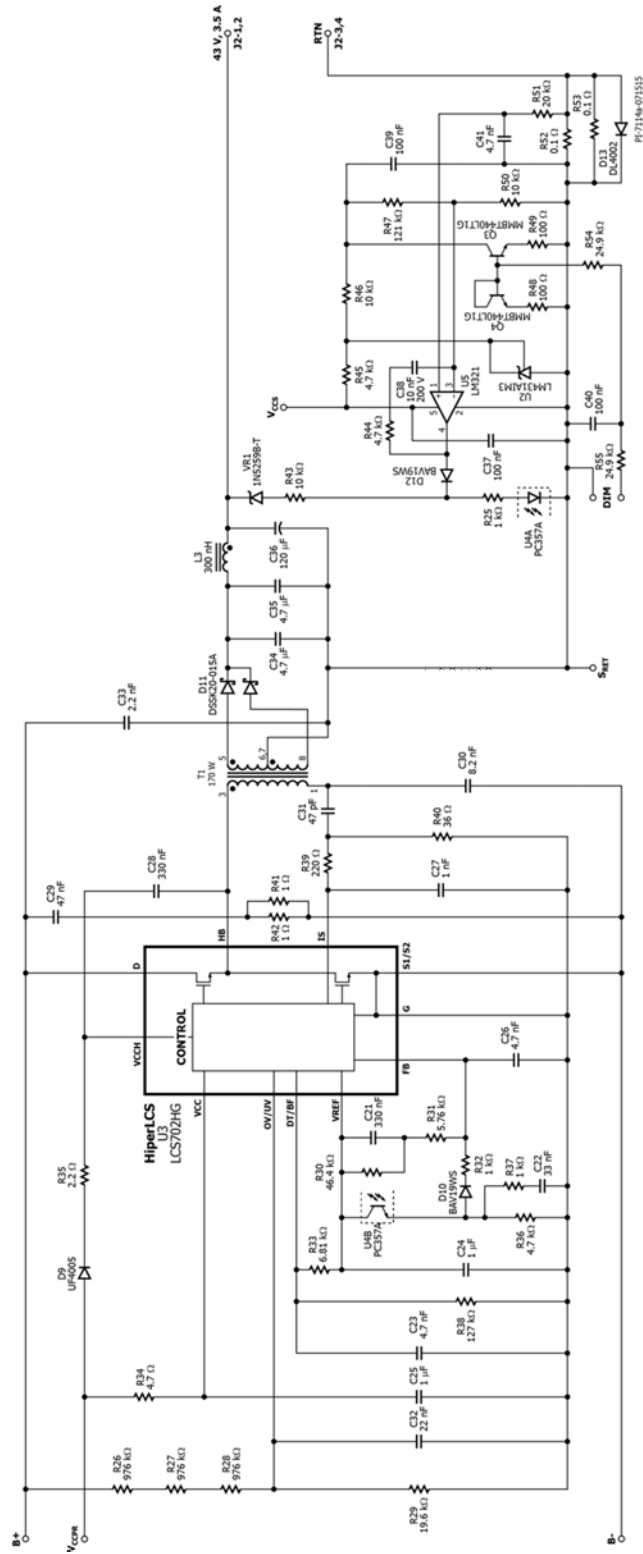


Figure 4 – Schematic of RD-382 Street light Power Supply Application Circuit, LLC Stage.



## 4 Circuit Description

### 4.1 Input Filter / Boost Converter / Bias Supply

The schematic in Figure 3 shows the input EMI filter, PFC stage, and primary bias supply/startup circuit. The power factor corrector utilizes the PFS7326H. The primary and secondary bias supplies are derived from windings on the PFC inductor (L2).

### 4.2 EMI Filtering / Inrush Limiting

Capacitors C1 and C2 are used to control differential mode noise. Resistor R1 is used for damping, improving power factor and reducing EMI. Resistors R2-4 discharge C1 and C2 when AC power is removed. Inductor L1 controls common mode EMI. The heat sink for U1, U3, and BR1 is connected to primary return to eliminate the heat sink as a source of radiated/capacitively coupled noise. Thermistor RT1 provides inrush limiting. Capacitor C33 (Figure 4) filters common mode EMI. Inductor L4 filters differential mode EMI.

### 4.3 Main PFC Stage

Components R17-19 and R23 provide output voltage feedback. Capacitor C15 provides fast dv/dt feedback to the U1 FB pin for rapid undershoot and overshoot response of the PFC circuit. Frequency compensation is provided by C19, C20, and R21, R22, and R24. Resistors R10-12 (filtered by C10) provide input voltage information to U1. Resistor R13 (filtered by C11) programs the U1 for "efficiency" mode. For more information about HiperPFS-2 efficiency mode, please refer to the HiperPFS-2 data sheet. Resistor R14 programs the "power good" threshold for U1.

Capacitor C12 provides local bypassing for U1. Diode D2 charges the PFC output capacitor (C14) when AC is first applied, routing the inrush current away from PFC inductor L2 and the internal output diode of U1. Capacitor C13 and R15-16 are used to reduce the length of the high frequency loop around components U1 and C14, reducing EMI. The resistors in series with C13 damp mid-band EMI peaks. The incoming AC is rectified by BR1 and filtered by C9. Capacitor C9 was selected as a low-loss polypropylene type to provide the high instantaneous current through L2 during U1 on-time. Thermistor RT1 limits inrush current at startup.

### 4.4 Primary Bias Supply / Start-up

Components R5-7, R8-R9, Q1, and VR3 provide startup bias for U1. Once U1 starts, components D1, D3, and C3-5 generate a primary-referred bias supply via a winding on PFC choke L2. This is used to power both the PFC and LLC stages of the power supply. Once the primary bias supply voltage is established, it is used to turn off MOSFET Q1 via diode D6, reducing power consumption. Resistors R8 and R9 protect Q1 from excessive power dissipation if the power supply fails to start.

Components D7, Q2, C16-17 and VR2 regulate the bias supply voltage for U1 and U3. Components D4 and D5 and C6-8 generate a bias supply for the secondary control circuitry via a triple insulated winding on L2.

#### **4.5 LLC Converter**

The schematic in Figures 4 depicts a ~43 V, 150 W LLC DC-DC converter with constant current output implemented using the LCS702HG.

#### **4.6 Primary**

Integrated circuit U3 incorporates the control circuitry, drivers and output MOSFETs necessary for an LLC resonant half-bridge (HB) converter. The HB output of U3 drives output transformer T1 via a blocking/resonating capacitor (C30). This capacitor was rated for the operating ripple current and to withstand the high voltages present during fault conditions.

Transformer T1 was designed for a leakage inductance of 49  $\mu$ H. This, along with resonating capacitor C30, sets the primary series resonant frequency at ~259 kHz according to the equation:

$$f_R = \frac{1}{6.28\sqrt{L_L \times C_R}}$$

Where  $f_R$  is the series resonant frequency in Hertz,  $L_L$  is the transformer leakage inductance in Henries, and  $C_R$  is the value of the resonating capacitor (C30) in Farads.

The transformer turns ratio was set by adjusting the primary turns such that the operating frequency at nominal input voltage and full load is close to, but slightly less than, the previously described resonant frequency.

An operating frequency of 250 kHz was found to be a good compromise between transformer size, output filter capacitance (enabling ceramic/film capacitors), and efficiency.

The number of secondary winding turns was chosen to provide a good compromise between core and copper losses. AWG #44 Litz wire was used for the primary and AWG #42 Litz wire, for the secondary, this combination providing high-efficiency at the operating frequency (~250 kHz). The number of strands within each gauge of Litz wire was chosen in order to achieve a balance between winding fit and copper losses.

The core material selected was PW4 (from Itacoil). This material provided good (low loss) performance.

Components D9, R35, and C28 comprise the bootstrap circuit to supply the internal high-side driver of U3.

Components R34 and C25 provide filtering and bypassing of the +12 V input and the  $V_{CC}$  supply for U1. *Note:  $V_{CC}$  voltage of >15 V may damage U3.*

Voltage divider resistors R26-29 set the high-voltage turn-on, turn-off, and overvoltage thresholds of U3. The voltage divider values are chosen to set the LLC turn-on point at 360 VDC and the turn-off point at 285 VDC, with an input overvoltage turn-off point at 473 VDC. Built-in hysteresis sets the input undervoltage turn-off point at 280 VDC.

Capacitor C29 is a high-frequency bypass capacitor for the +380 V input, connected with short traces between the D and S1/S2 pins of U3. Series resistors R41-42 provide EMI damping.

Capacitor C31 forms a current divider with C30, and is used to sample a portion of the primary current. Resistor R40 senses this current, and the resulting signal is filtered by R39 and C27. Capacitor C31 should be rated for the peak voltage present during fault conditions, and should use a stable, low-loss dielectric such as metalized film, SL ceramic, or NPO/COG ceramic. The capacitor used in the RD-382 was a ceramic disc with "SL" temperature characteristic, commonly used in the drivers for CCFL tubes. The values chosen set the 1 cycle (fast) current limit at 4.25 A, and the 7-cycle (slow) current limit at 2.35 A, according to the equation:

$$I_{CL} = \frac{0.5}{\left(\frac{C31}{C30 + C31}\right) \times R40}$$

$I_{CL}$  is the 7-cycle current limit in Amperes, R40 is the current limit resistor in Ohms, and C30 and C31 are the values of the resonating and current sampling capacitors in nanofarads, respectively. For the one-cycle current limit, substitute 0.9 V for 0.5 V in the above equation.

Resistor R39 and capacitor C27 filter primary current signal to the IS pin. Resistor R39 is set to 220  $\Omega$ , the minimum recommended value. The value of C27 is set to 1 nF to avoid nuisance tripping due to noise, but not so high as to substantially affect the current limit set values as calculated above. These components should be placed close to the IS pin for maximum effectiveness. The IS pin can tolerate negative currents, the current sense does not require a complicated rectification scheme.

The Thevenin equivalent combination of R33 and R38 sets the dead time at 330 ns and maximum operating frequency for U3 at 847 kHz. The DT/BF input of U3 is filtered by

C23. The combination of R33 and R38 also selects burst mode “1” for U3. This sets the lower and upper burst threshold frequencies at 382 kHz and 437 kHz, respectively.

The FEEDBACK pin has an approximate characteristic of 2.6 kHz per  $\mu\text{A}$  into the FEEDBACK pin. As the current into the FEEDBACK pin increases so does the operating frequency of U3, reducing the output voltage. The series combination of R30 and R31 sets the minimum operating frequency for U3 at  $\sim 160$  kHz. This value was set to be slightly lower than the frequency required for regulation at full load and minimum bulk capacitor voltage. Resistor R30 is bypassed by C21 to provide output soft start during start-up by initially allowing a higher current to flow into the FEEDBACK pin when the feedback loop is open. This causes the switching frequency to start high and then decrease until the output voltage reaches regulation. Resistor R31 is typically set at the same value as the parallel combination of R33 and R38 so that the initial frequency at soft-start is equal to the maximum switching frequency as set by R33 and R38. If the value of R31 is less than this, it will cause a delay before switching occurs when the input voltage is applied.

Optocoupler U4 drives the U3 FEEDBACK pin through R32, which limits the maximum optocoupler current into the FEEDBACK pin. Capacitor C26 filters the FEEDBACK pin. Resistor R36 loads the optocoupler output to force it to run at a relatively high quiescent current, increasing its gain. Resistors R32 and R36 also improve large signal step response and burst mode output ripple. Diode D10 isolates R36 from the  $F_{\text{MAX}}$ /soft start network.

#### ***4.7 Output Rectification***

The output of transformer T1 is rectified and filtered by D11 and C34-35. These capacitors have a polyester dielectric, chosen for output ripple current rating. Output rectifier D11 is a 150 V Schottky rectifier chosen for high efficiency. Intertwining the transformer secondary halves (see transformer construction details in section 8) reduces leakage inductance between the two secondary halves, reducing the worst-case peak inverse voltage and allowing use of a 150V Schottky diode with consequent higher efficiency. Additional output filtering is provided by L3 and C36. Capacitor C36 also damps the LLC output impedance peak at  $\sim 30$  kHz caused by the LLC “virtual” output series R-L and output capacitors C34-35.

#### ***4.8 Output Current and Voltage Control***

Output current is sensed via resistors R52 and R53. These resistors are clamped by diode D13 to avoid damage to the current control circuitry during an output short circuit. Components R45 and U2 provide a voltage reference for current sense amplifier U5. The reference voltage is divided down by R46-47 and R50, and filtered by C39. Voltage from the current sense resistor is filtered by R51 and C41 and applied to the non-inverting input of U5. Opamp U5 drives optocoupler U4 via D12 and R25. Components R25, R44, R51, C38, and C41 are used for frequency compensation of the current loop.

Components VR1 and R43 provide output voltage sensing to protect the power supply in case the output load is removed. These components were selected using a relatively large value for R43 and a relatively low voltage for VR1 to provide a soft voltage limiting characteristic. This helps prevent oscillation at the knee of the V-I curve and improves the startup characteristics of the supply into the specified LED load.

Components J3, Q3-4, R48-49, R54-55, R46, and C40 are used to provide a remote dimming capability. A dimming voltage at J3 is converted to a current by R54 and R55 and applied to R46 via current mirror Q3-Q4. This current pulls down on the reference voltage to current sense amplifier U5 and reduces the programmed output current. A dimming voltage of 0-10 VDC provides an output current range of 100% at 0 V to ~20% at 10 VDC input.



## 5 PCB Layout

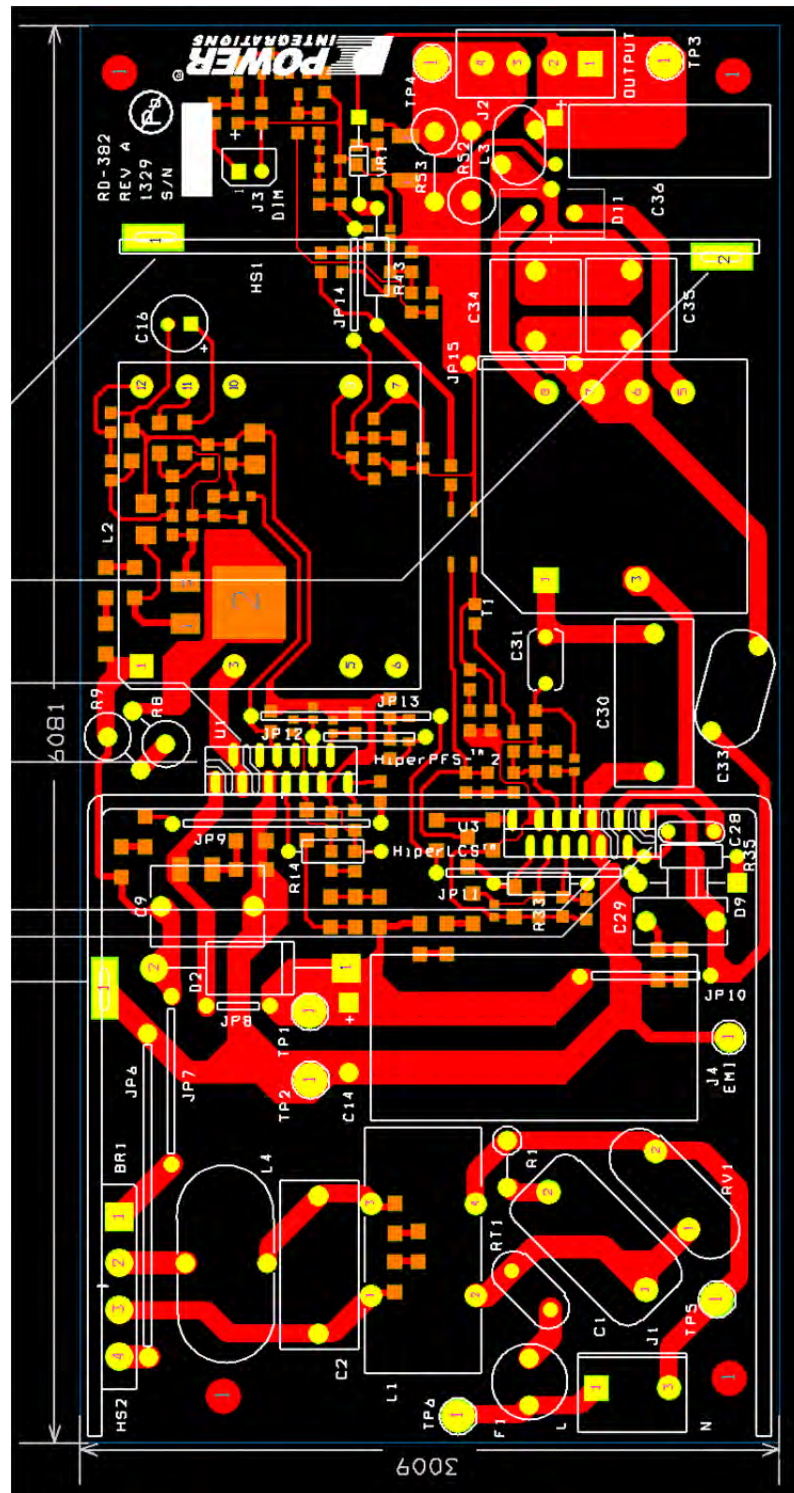


Figure 5 – Printed Circuit Layout, Top Side.

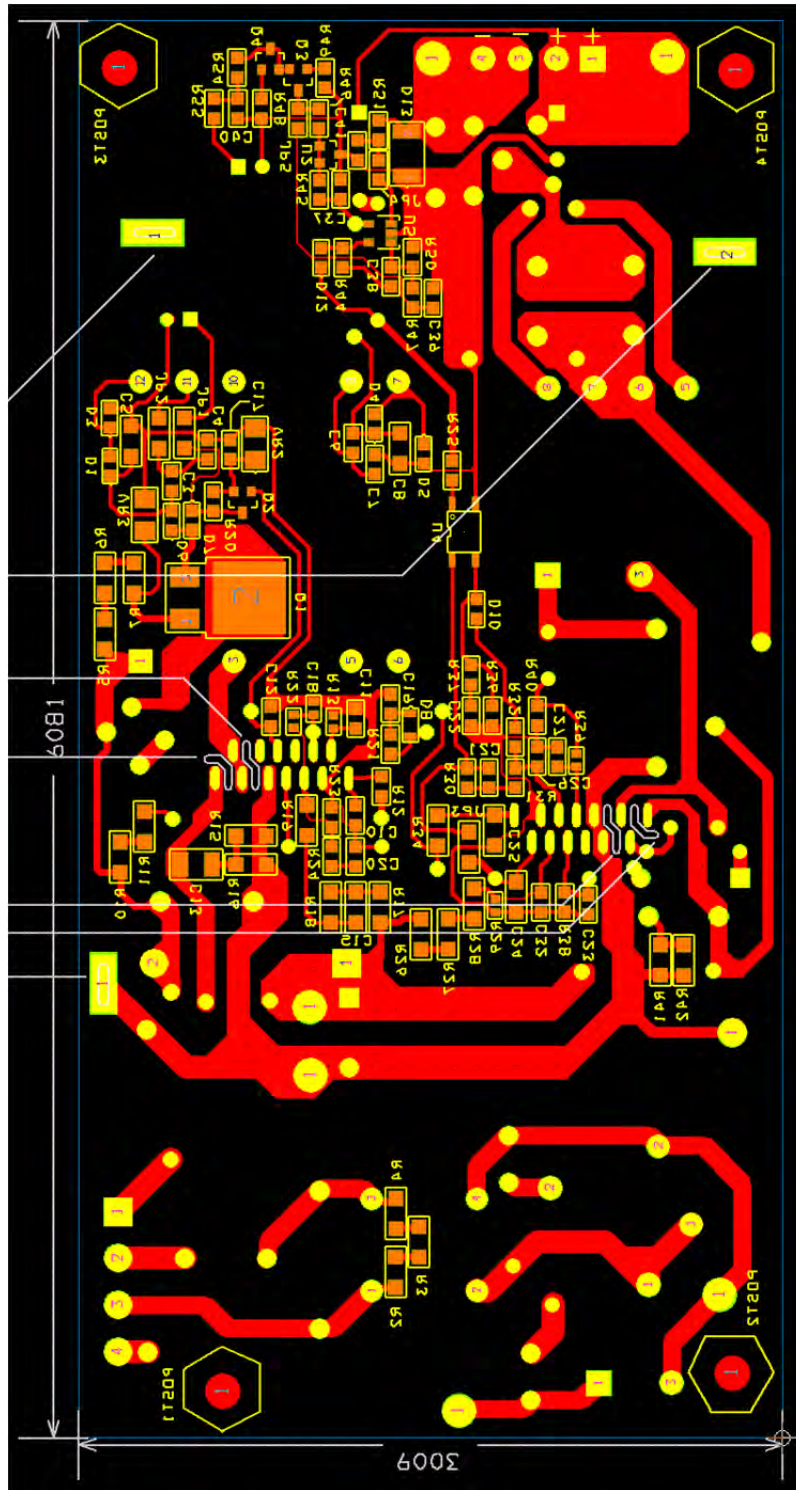


Figure 6 – Printed Circuit Layout, Bottom Side.





## 6 Bill of Materials

Item	Qty	Ref Des	Description	Mfg Part Number	Mfg
1	1	BR1	600 V, 8 A, Bridge Rectifier, GBU Case	GBU8J-BP	Micro Commercial
2	1	C1	470 nF, 275 VAC, Film, X2	PX474K31D5	Carli
3	1	C2	220 nF, 275 VAC, Film, X2	ECQ-U2A224ML	Panasonic
4	7	C3 C4 C6 C7 C37 C39 C40	100 nF, 50 V, Ceramic, X7R, 0805	CC0805KRX7R9BB104	Yageo
5	2	C5 C8	1 $\mu$ F, 100 V, Ceramic, X7R, 1206	HMK316B7105KL-T	Taiyo Yuden
6	1	C9	470 nF, 450 V, METALPOLYPRO	ECW-F2W474JAQ	Panasonic
7	1	C10	22 nF, 50 V, Ceramic, X7R, 0805	ECJ-2VB1H223K	Panasonic
8	1	C11	1 nF, 200 V, Ceramic, X7R, 0805	08052C102KAT2A	AVX
9	1	C12	3.3 $\mu$ F, 25 V, Ceramic, X7R, 0805	C2012X7R1E335K	TDK
10	1	C13	22 nF, 630 V, Ceramic, X7R, 1210	GRM32QR72J223KW01L	Murata
11	1	C14	120 $\mu$ F, 450 V, Electrolytic, 20 %, (18 x 37mm)	450BXW120MEFC18X35	Rubycon
12	1	C15	47 nF, 200 V, Ceramic, X7R, 1206	12062C473KAT2A	AVX
13	1	C16	47 $\mu$ F, 50 V, Electrolytic, 20 %, (6.3 x 12.5 mm)	50YXM47MEFC6.3X11	Rubycon
14	2	C17 C19	2.2 $\mu$ F, 25 V, Ceramic, X7R, 0805	C2012X7R1E225M	TDK
15	1	C18	22 nF 50 V, Ceramic, X7R, 0603	C1608X7R1H223K	TDK
16	1	C20	47 nF, 50 V, Ceramic, X7R, 0805	GRM21BR71H473KA01L	Murata
17	1	C21	330 nF, 50 V, Ceramic, X7R, 0805	GRM219R71H334KA88D	Murata
18	1	C22	33 nF, 50 V, Ceramic, X7R, 0805	CC0805KRX7R9BB333	Yageo
19	3	C23 C26 C41	4.7 nF, 200 V, Ceramic, X7R, 0805	08052C472KAT2A	AVX
20	2	C24 C25	1 $\mu$ F, 25 V, Ceramic, X7R, 1206	C3216X7R1E105K	TDK
21	1	C27	1 nF, 200 V, Ceramic, X7R, 0805	08052C102KAT2A	AVX
22	1	C28	330 nF, 50 V, Ceramic, X7R	FK24X7R1H334K	TDK
23	1	C29	47 nF, 630 V, Film	MEXPD24704JJ	Duratech
24	1	C30	8.2 nF, 1000V VDC, Film	B32671L0822J000	Epcos
25	1	C31	47 pF, 1 kV, Disc Ceramic	DEA1X3A470JC1B	Murata
26	1	C32	22 nF, 200 V, Ceramic, X7R, 0805	08052C223KAT2A	AVX
27	1	C33	2.2 nF, Ceramic, Y1	440LD22-R	Vishay
28	2	C34 C35	4.7 $\mu$ F, 63 V, Polyester Film	B32560J475K	Epcos
29	1	C36	120 $\mu$ F, 63 V, Electrolytic, Gen. Purpose, (8 x 22)	EEU-FR1J121LB	Panasonic
30	1	C38	10 nF, 200 V, Ceramic, X7R, 0805	08052C103KAT2A	AVX
31	2	CLIP_LCS_PFS1 CLIP_LCS_PFS2	Heat sink Hardware, Clip LCS_II/PFS	EM-285V0	Kang Yang Hardware Enterprise
32	8	D1 D3 D4 D5 D6 D7 D10 D12	100 V, 0.2 A, Fast Switching, 50 ns, SOD-323	BAV19WS-7-F	Diodes, Inc.
33	1	D2	1000 V, 3 A, Rectifier, DO-201AD	1N5408-T	Diodes, Inc.
34	1	D8	75 V, 200 mA, Rectifier, SOD323	BAS16HT1G	ON Semi
35	1	D9	600 V, 1 A, Ultrafast Recovery, 75 ns, DO-41	UF4005-E3	Vishay
36	1	D11	150 V, 20 A, Schottky, TO-220AB	DSSK 20-015A	IXYS
37	1	D13	100 V, 1 A, Rectifier, Glass Passivated, DO-213AA (MELF)	DL4002-13-F	Diodes, Inc.
38	1	F1	5 A, 250V, Slow, TR5	37215000411	Wickman
39	1	HS1	HEAT SINK, Custom, Al, 3003, 0.062" Thk		Custom
40	1	HS2	HEAT SINK, Custom, Al, 3003, 0.062" Thk		Custom
41	1	J1	3 Position (1 x 3) header, 0.156 pitch, Vertical	B3P-VH	JST
42	1	J2	4 Position (1 x 4) header, 0.156 pitch, Vertical	26-48-1045	Molex
43	1	J3	2 Position (1 x 2) header, 0.1 pitch, Vertical	22-23-2021	Molex
44	3	JP1 JP2 JP3	0 $\Omega$ , 5%, 1/4 W, Thick Film, 1206	ERJ-8GEYOR00V	Panasonic

45	2	JP4 JP5	0 $\Omega$ , 5%, 1/8 W, Thick Film, 0805	ERJ-6GEY0R00V	Panasonic
46	1	JP6	Wire Jumper, Insulated, TFE, #18 AWG, 1.4 in	C2052A-12-02	Alpha
47	1	JP7	Wire Jumper, Non insulated, #22 AWG, 0.7 in	298	Alpha
48	1	JP8	Wire Jumper, Non insulated, #22 AWG, 0.3 in	298	Alpha
49	1	JP9	Wire Jumper, Insulated, #24 AWG, 0.9 in	C2003A-12-02	Gen Cable
50	1	JP10	Wire Jumper, Non insulated, #22 AWG, 0.6 in	298	Alpha
51	1	JP11	Wire Jumper, Non insulated, #22 AWG, 0.8 in	298	Alpha
52	2	JP12 JP15	Wire Jumper, Non insulated, #22 AWG, 0.5 in	298	Alpha
53	1	JP13	Wire Jumper, Insulated, #24 AWG, 0.8 in	C2003A-12-02	Gen Cable
54	1	JP14	Wire Jumper, Insulated, #24 AWG, 0.5 in	C2003A-12-02	Gen Cable
55	1	L1	9 mH, 5 A, Common Mode Choke	T22148-902S P.I. Custom	Fontaine
56	1	L2	Custom, RD-382 PFC Choke, 437 $\mu$ H, PQ32/30, Vertical, 9 pins		Power Integrations
57	1	L3	Output Inductor, Custom, 300 nH, $\pm$ 15%, constructed on Micrometals T30-26 toroidal core		Power Integrations
58	1	L4	150 $\mu$ H, 3.4 A, Vertical Toroidal	2114-V-RC	Bourns
59	4	POST1 POST2 POST3 POST4	Post, Circuit Board, Female, Hex, 6-32, snap, 0.375L, Nylon	561-0375A	Eagle Hardware
60	1	Q1	400 V, 2 A, 4.4 Ohm, 600 V, N-Channel, DPAK	IRFRC20TRPBF	Vishay
61	3	Q2 Q3 Q4	NPN, Small Signal BJT, GP SS, 40 V, 0.6 A, SOT-23	MMBT4401LT1G	Diodes, Inc.
62	1	R1	4.7 $\Omega$ , 2 W, Flame Proof, Pulse Withstanding, Wire Wound	WHS2-4R7JA25	IT Elect_Welwyn
63	3	R2 R3 R4	680 k $\Omega$ , 5%, 1/4 W, Thick Film, 1206	ERJ-8GEYJ684V	Panasonic
64	3	R5 R6 R7	1.3 M $\Omega$ , 5%, 1/4 W, Thick Film, 1206	ERJ-8GEYJ135V	Panasonic
65	2	R8 R9	7.5 k $\Omega$ , 5%, 1 W, Metal Oxide	RSF100JB-7K5	Yageo
66	3	R10 R11 R17	1.50 M $\Omega$ , 1%, 1/4 W, Thick Film, 1206	ERJ-8ENF1504V	Panasonic
67	1	R12	1 M $\Omega$ , 1%, 1/8 W, Thick Film, 0805	ERJ-6ENF1004V	Panasonic
68	1	R13	49.9 k $\Omega$ , 1%, 1/16 W, Thick Film, 0603	ERJ-3EKF4992V	Panasonic
69	1	R14	100 k $\Omega$ , 1%, 1/4 W, Metal Film	MFR-25FBF-100K	Yageo
70	3	R15 R16 R34	4.7 $\Omega$ , 5%, 1/4 W, Thick Film, 1206	ERJ-8GEYJ4R7V	Panasonic
71	1	R18	787 k $\Omega$ , 1%, 1/4 W, Thick Film, 1206	ERJ-8ENF7873V	Panasonic
72	1	R19	1.60 M $\Omega$ , 1%, 1/4 W, Thick Film, 1206	ERJ-8ENF1604V	Panasonic
73	1	R20	39 k $\Omega$ , 5%, 1/8 W, Thick Film, 0805	ERJ-6GEYJ393V	Panasonic
74	1	R21	6.2 k $\Omega$ , 5%, 1/8 W, Thick Film, 0805	ERJ-6GEYJ622V	Panasonic
75	1	R22	487 k $\Omega$ , 1%, 1/16 W, Thick Film, 0603	ERJ-3EKF4873V	Panasonic
76	1	R23	60.4 k $\Omega$ , 1%, 1/8 W, Thick Film, 0805	ERJ-6ENF6042V	Panasonic
77	1	R24	3 k $\Omega$ , 5%, 1/8 W, Thick Film, 0805	ERJ-6GEYJ302V	Panasonic
78	3	R25 R32 R37	1 k $\Omega$ , 5%, 1/8 W, Thick Film, 0805	ERJ-6GEYJ102V	Panasonic
79	3	R26 R27 R28	976 k $\Omega$ , 1%, 1/4 W, Thick Film, 1206	ERJ-8ENF9763V	Panasonic
80	1	R29	19.6 k $\Omega$ , 1%, 1/16 W, Thick Film, 0603	ERJ-3EKF1962V	Panasonic
81	1	R30	46.4 k $\Omega$ , 1%, 1/8 W, Thick Film, 0805	ERJ-6ENF4642V	Panasonic
82	1	R31	5.76 k $\Omega$ , 1%, 1/8 W, Thick Film, 0805	ERJ-6ENF5761V	Panasonic
83	1	R33	6.81 k $\Omega$ , 1%, 1/4 W, Metal Film	MFR-25FBF-6K81	Yageo
84	1	R35	2.2 $\Omega$ , 5%, 1/4 W, Carbon Film	CFR-25JB-2R2	Yageo
85	3	R36 R44 R45	4.7 k $\Omega$ , 5%, 1/8 W, Thick Film, 0805	ERJ-6GEYJ472V	Panasonic
86	1	R38	127 k $\Omega$ , 1%, 1/8 W, Thick Film, 0805	ERJ-6ENF1273V	Panasonic
87	1	R39	220 $\Omega$ , 5%, 1/10 W, Thick Film, 0603	ERJ-3GEYJ221V	Panasonic
88	1	R40	36 $\Omega$ , 5%, 1/8 W, Thick Film, 0805	ERJ-6GEYJ360V	Panasonic
89	2	R41 R42	1 $\Omega$ , 5%, 1/4 W, Thick Film, 1206	ERJ-8GEYJ1R0V	Panasonic
90	1	R43	10 k $\Omega$ , 5%, 1/4 W, Carbon Film	CFR-25JB-10K	Yageo
91	2	R46 R50	10 k $\Omega$ , 1%, 1/8 W, Thick Film, 0805	ERJ-6ENF1002V	Panasonic



92	1	R47	121 k $\Omega$ , 1%, 1/8 W, Thick Film, 0805	ERJ-6ENF1213V	Panasonic
93	2	R48 R49	100 $\Omega$ , 5%, 1/8 W, Thick Film, 0805	ERJ-6GEYJ101V	Panasonic
94	1	R51	20 k $\Omega$ , 5%, 1/8 W, Thick Film, 0805	ERJ-6GEYJ203V	Panasonic
95	2	R52 R53	0.1 $\Omega$ , 5%, 2 W, Thick Oxide	MO200J0R1B	Synton-Tech
96	2	R54 R55	24.9 k $\Omega$ , 1%, 1/8 W, Thick Film, 0805	ERJ-6ENF2492V	Panasonic
97	1	RT1	NTC Thermistor, 2.5 $\Omega$ , 5 A	SL10 2R505	Ametherm
98	4	RTV1 RTV2 RTV3 RTV4	Thermally conductive Silicone Grease	120-SA	Wakefield
99	1	RV1	320 V, 80 J, 14 mm, RADIAL	V320LA20AP	Littlefuse
100	4	SCREW1 SCREW2 SCREW3 SCREW4	SCREW MACHINE PHIL 6-32 X 5/16 SS	PMSSS 632 0031 PH	Building Fasteners
101	2	SPACER_CER1 SPACER_CER2	SPACER RND, Steatite C220 Ceramic	CER-2	Richco
102	1	T1	Integrated Resonant Transformer, Horizontal, 8 pins	TRLEV25043A	Itacoil
103	2	TP1 TP3	Test Point, RED, THRU-HOLE MOUNT	5010	Keystone
104	4	TP2 TP4 TP5 TP6	Test Point, BLK, THRU-HOLE MOUNT	5011	Keystone
105	1	U1	HiperPFS-2, ESIP16/13	PFS7326H	Power Integrations
106	1	U2	IC, REG ZENER SHUNT ADJ SOT-23	LM431AIM3/NOPB	National Semi
107	1	U3	HiperLCS, ESIP16/13	LCS702HG	Power Integrations
108	1	U4	Optocoupler, 80 V, CTR 80-160%, 4-Mini Flat	PC357N1TJ00F	Sharp
109	1	U5	OP AMP SINGLE LOW PWR SOT23-5	LM321MF	National Semi
110	1	VR1	39 V, 5%, 500 mW, DO-35	1N5259B-T	Diodes, Inc.
111	1	VR2	12 V, 5%, 500 mW, DO-213AA (MELF)	ZMM5242B-7	Diodes, Inc.
112	1	VR3	18 V, 5%, 500 mW, DO-213AA (MELF)	ZMM5248B-7	Diodes, Inc.
114	4	WASHER1 WASHER2 WASHER3 WASHER4	Washer Flat #6, SS, Zinc Plate, 0.267 OD x 0.143 ID x 0.032 Thk	620-6Z	Olander

## 7 LED Panel Characterization

A commercial 150 W LED streetlight was used to test the RD-382 power supply. The LED array consisted of (6) 7 X 4 panels, as 4 wide, 7 deep. For the purposes of testing, the six panels were connected in series-parallel, resulting in an LED array 12 wide, 14 deep (see Figures 8 and 9). The V-I characteristic of the LED panels connected in this manner is shown below in Figure 7.

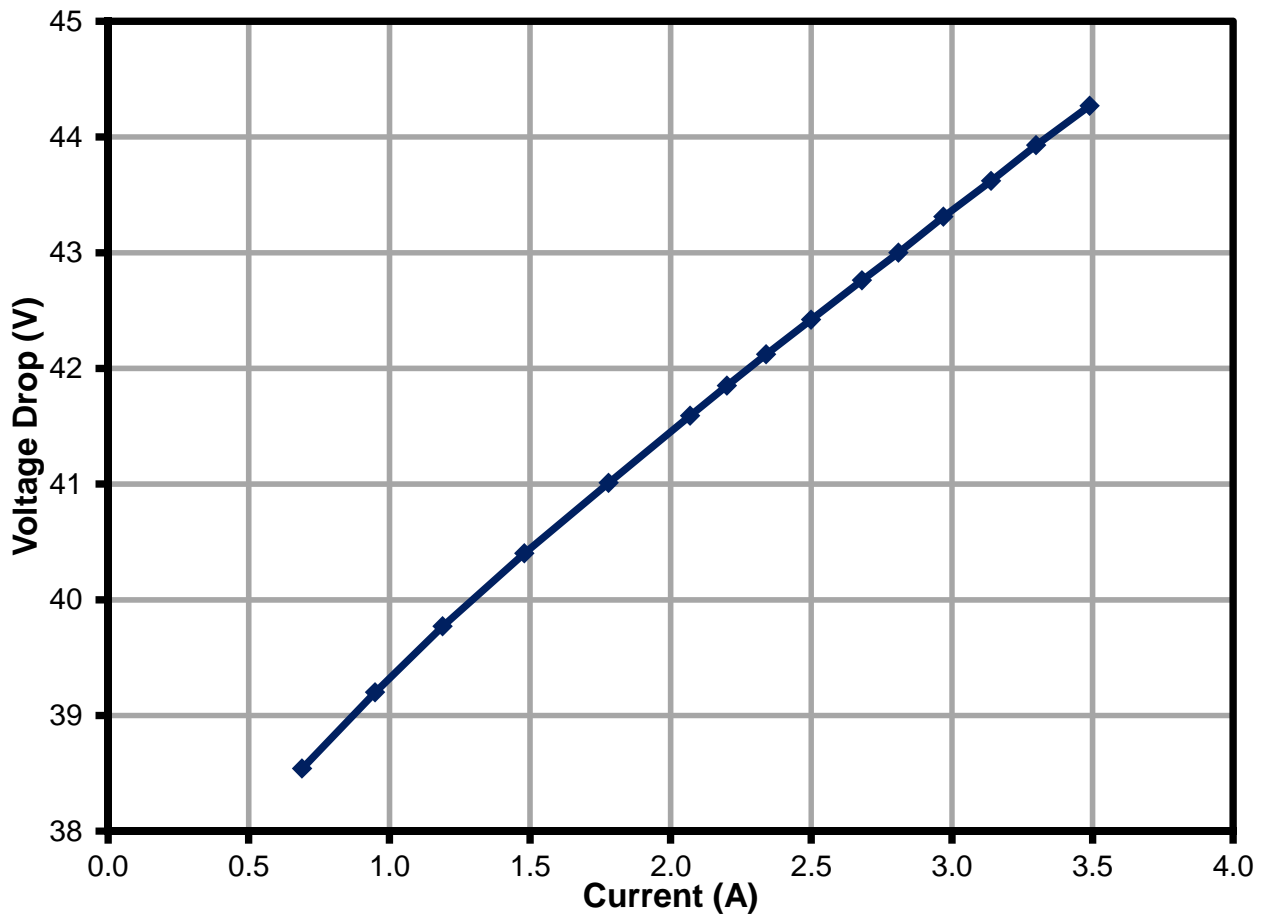


Figure 7 – Streetlight LED Array V-I Characteristic.

### 7.1 LED Panel Current Sharing

For the purpose of this report, the six LED panels in the street light were partitioned into 3 sections, each section consisting of two LED panels in series. Each panel was internally connected as an array of LEDs 4 wide and 7 deep so that two panels connected in series consisted of an array of LEDs 4 wide by 14 deep. The three sections were connected in parallel, forming a total LED load 12 wide and 14 deep. Using a DC current probe, the current in each 4 wide by 14 deep section was measured to determine the current distribution between sections, with results shown below.

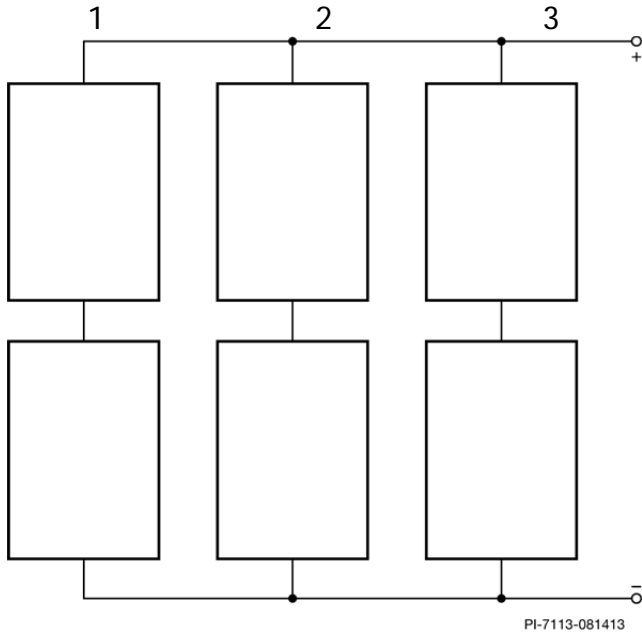


Figure 8 – LED Test Panel Layout.

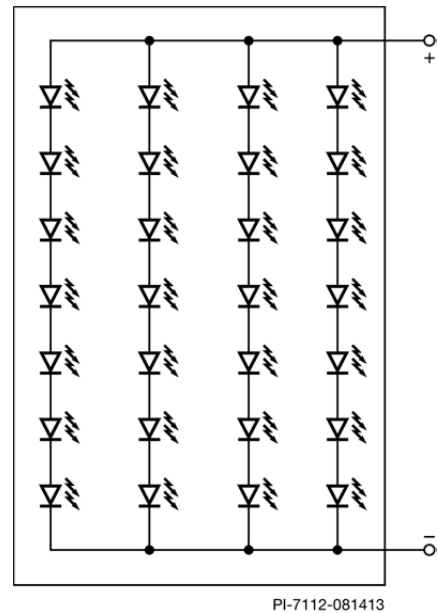


Figure 9 – Array of LEDs in Each Test Panel.

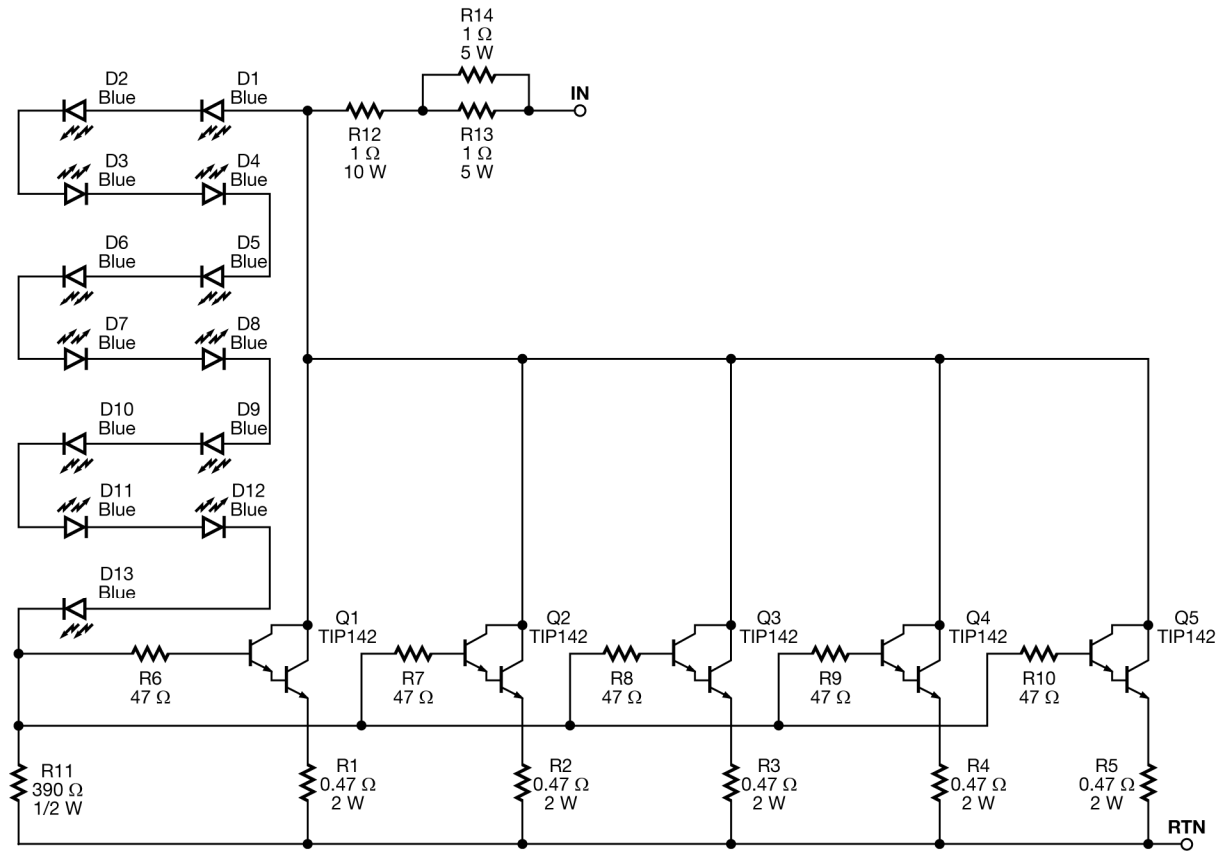
Section #	1	2	3
Current (A)	1.113 A	1.159 A	1.126 A

Maximum difference between sections was <5%.

## ***7.2 Constant Voltage Load***

Since this power supply has a constant current output tailored for a relatively fixed constant voltage load, the usual constant current electronic load cannot be used for testing. For bench testing at maximum power, a constant resistance load can be used, set such that the supply output is at maximum current and an output voltage of 43-44 V, as indicated by the V-I curve shown in Figure 7. Other testing, including dimming and gain-phase, will require the actual LED load or a constant voltage load that closely mimics its characteristics.

The streetlight LED as a load was both large and heavy. In order to facilitate EMI and surge testing, a constant voltage load was constructed to emulate the behavior of the LED array in a much smaller package. The circuit is shown in Figure 8. The load consists of paralleled power Darlington transistors Q1-5, each with an emitter resistor (R1-5) to facilitate current sharing. Base resistors R6-10 help prevent oscillation. A string of thirteen 3 mm blue LEDs (D1-13) are used as a voltage reference to mimic the characteristics of the LED panel. Resistor R11 is adjusted to vary the voltage at which the load turns on to match the characteristics of the LED panel. Resistors R12-14 add extra impedance in series with the load to approximate the characteristics of the LED panel. The completed array with heat sink is shown in Figure 9. A small fan was used to cool the heat sink when the load was operated for extended periods at full power. The V-I characteristics of the CV load are shown superimposed on those of the LED array in Figure 10. An electronic load with appropriate rating and a constant voltage option (with some series resistance) could also be used for testing, but this load has the advantage that no external AC power is needed.



PI-7134-092513

Figure 10 – Constant Voltage Load Schematic.



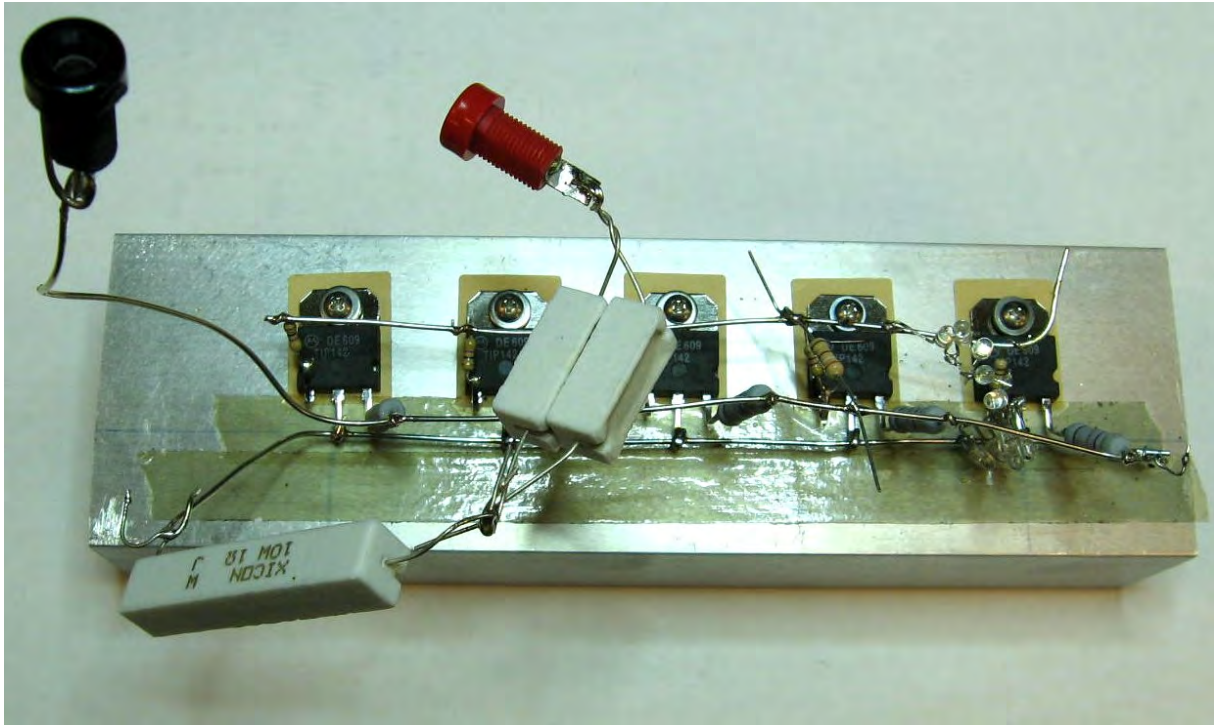


Figure 11 – Constant Voltage Load with Heat Sink.



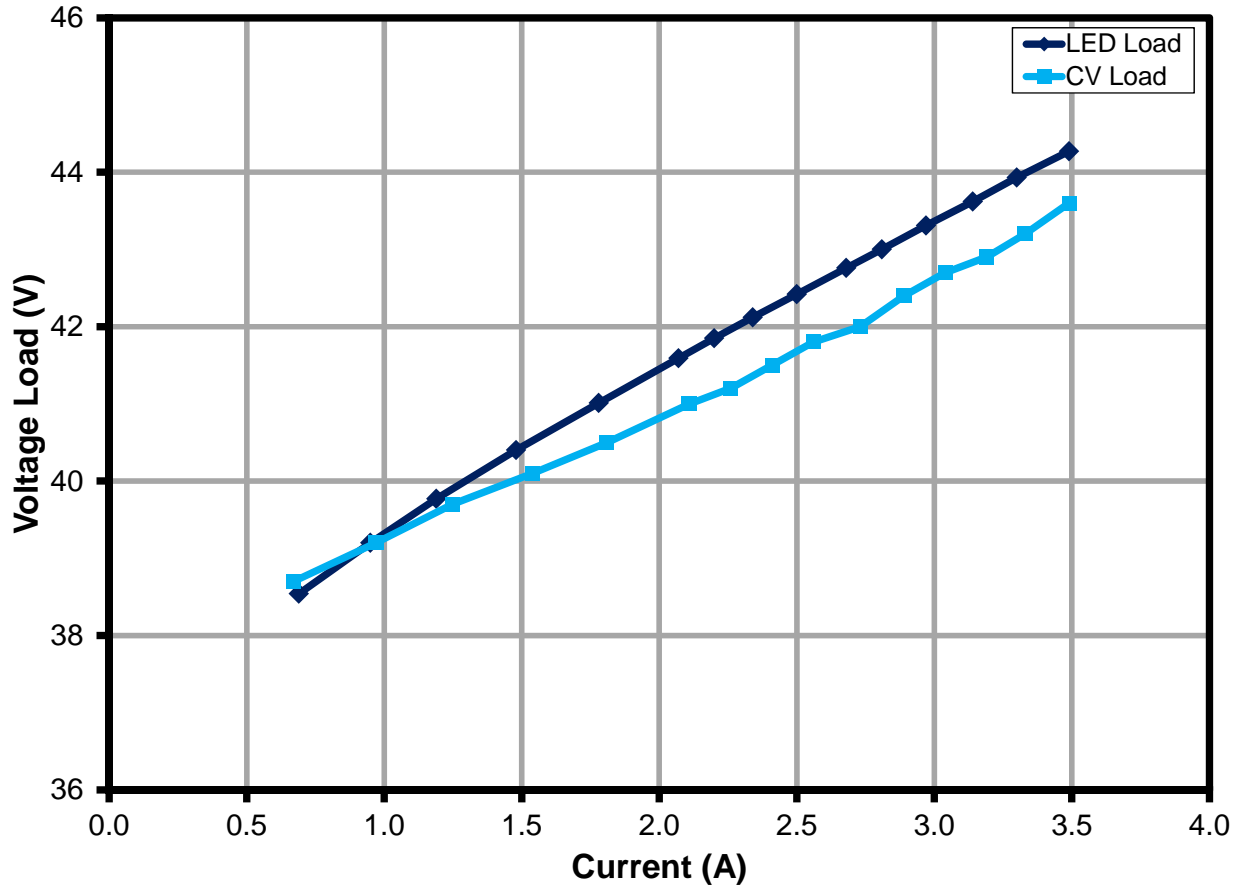


Figure 12 – Comparison of Streetlight LED Array V-I Characteristic with CV Load.



## 8 Magnetics

### 8.1 PFC Choke (L2) Specification

#### 8.1.1 Electrical Diagram

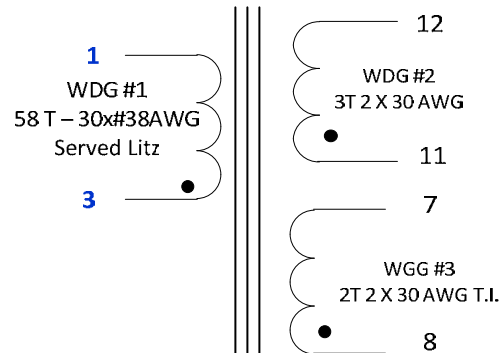


Figure 13 – PFC Choke Electrical Diagram.

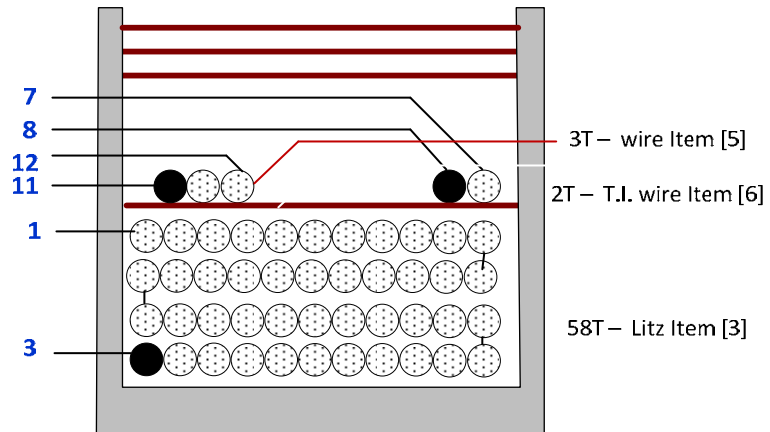
#### 8.1.2 Electrical Specifications

<b>Inductance</b>	Pins 1-3 measured at 100 kHz, 0.4 V <sub>RMS</sub> .	437 $\mu$ H +5%
<b>Resonant Frequency</b>	Pins 1-3. N/A	kHz (Min.)

#### 8.1.3 Materials

Item	Description
[1]	Core: TDK Core: PC44PQ32/20Z, gap for A <sub>L</sub> G of 130 nH/T <sup>2</sup> .
[2]	Bobbin: BPO32/20-112CPFR – TDK.
[3]	Litz Wire: 30 x #38 AWG Single Coated Solderable, Served.
[4]	Tape, Polyester Film: 3M 1350-F1 or equivalent, 9.0 mm wide.
[5]	Magnet Wire, 30 AWG, Solderable Double Coated.
[6]	Triple Insulated Wire, 30 AWG, Furukawa TEX-E or equivalent.
[7]	Varnish: Dolph BC-359, or equivalent.

**8.1.4 Build Diagram**



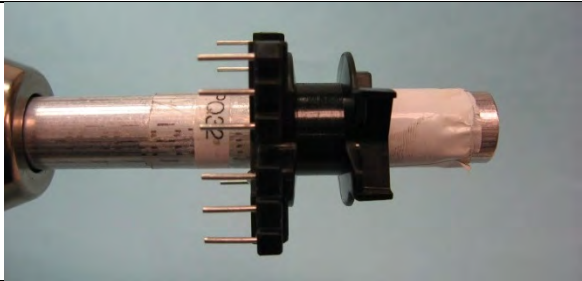
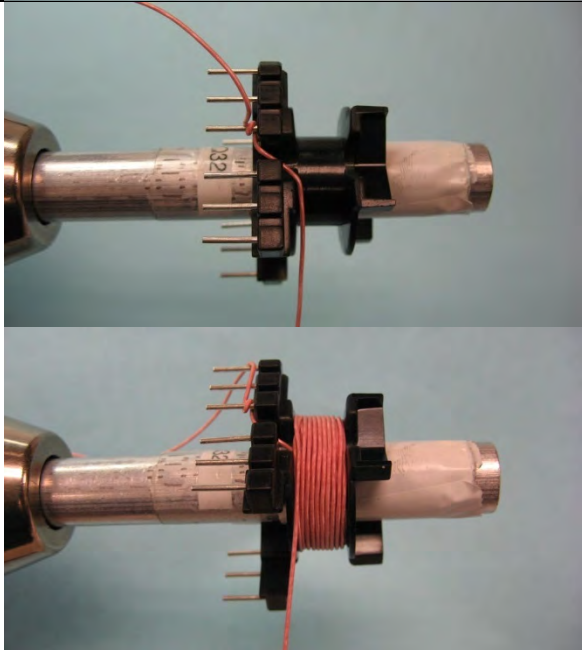
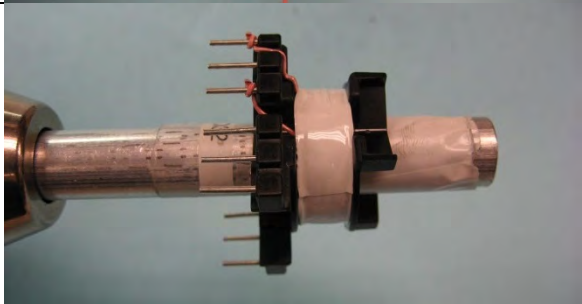
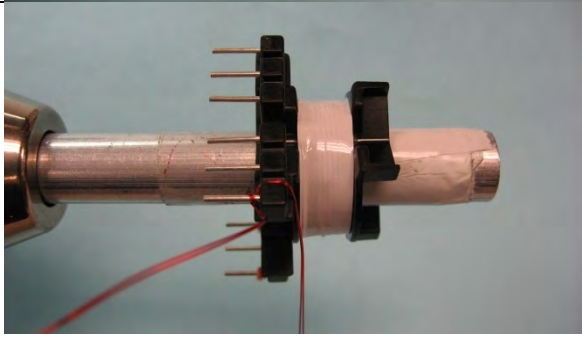
**Figure 14 – PFC Inductor Build Diagram.**

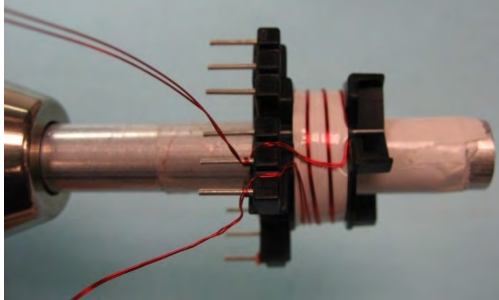
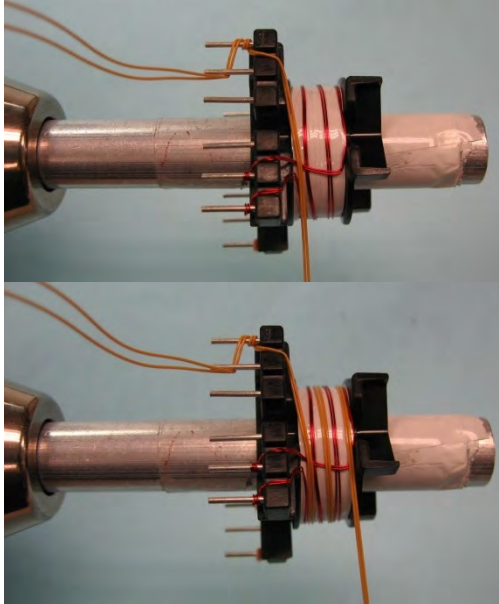
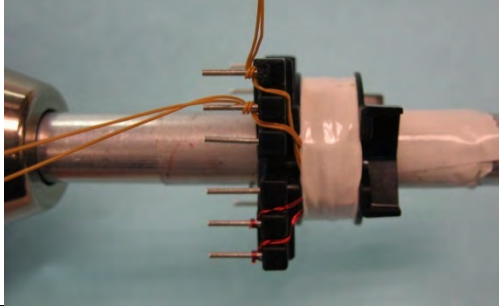

**8.1.5 Winding Instructions**

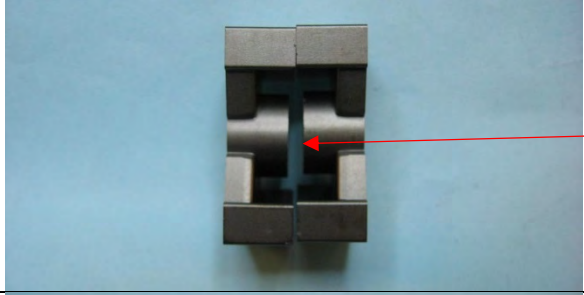

<b>Winding Preparation</b>	Place the bobbin on the mandrel with the pin side is on the left side. Winding direction is clockwise direction.
<b>Winding #1</b>	Starting at pin 3, wind 58 turns of Litz wire item [3], finish at pin 1.
<b>Insulation</b>	Apply one layer of tape item [4]
<b>Winding #2</b>	Starting at pin 11, wind 3 bifilar turns of wire, item [5]. Spread turns evenly across bobbin window. Finish at Pin 12.
<b>Winding #3</b>	Starting at pin 8, wind 2 bifilar turns of wire, item [6], directly on top of previous winding. Spread turns evenly across bobbin window. Finish at pin 7.
<b>Insulation</b>	Apply 3 layers of tape item [4].
<b>Final Assembly</b>	Grind core to specified inductance. Secure core halves with tape. Remove pins 2, 4, and 9. Dip varnish with item [7].



**8.1.6 Winding Illustrations**

<p><b>Winding Preparation</b></p>		<p>Place the bobbin on the mandrel with the pin side is on the left side. Winding direction is clockwise direction</p>
<p><b>Winding #1</b></p>		<p>Starting at pin 3, wind 58 turns with 30x #38 served Litz wire, item [3].</p>
<p><b>Insulation</b></p>		<p>Apply 1 layer of insulating tape, item [4]. Terminate wire at pin 1</p>
<p><b>Winding #2</b></p>		<p>Starting at pin 11, wind 3 bifilar turns with #30 AWG double coated wire, item [5].</p>

		<p>Terminate wire at pin 12.</p> <p>Do not apply insulating tape to this winding.</p>
<p><b>Winding #3</b></p>		<p>Starting at pin 8, wind 2 bifilar turns with #30 AWG triple insulated wire, item [6].</p>
<p><b>Insulation</b></p>		<p>Apply 3 layers of insulating tape, item [4].</p> <p>Terminate wire at pin 7</p>
<p><b>Solder Terminations</b></p>		<p>Solder all wire terminations at pins 1, 3, 7, 8, 11, and 12</p>

<b>Core Grinding</b>		Grind core for specified inductance.
<b>Final Assembly</b>		Secure core halves with tape. Remove pins 2, 4, and 9.

## 8.2 LLC Transformer (T1) Specification

### 8.2.1 Electrical Diagram

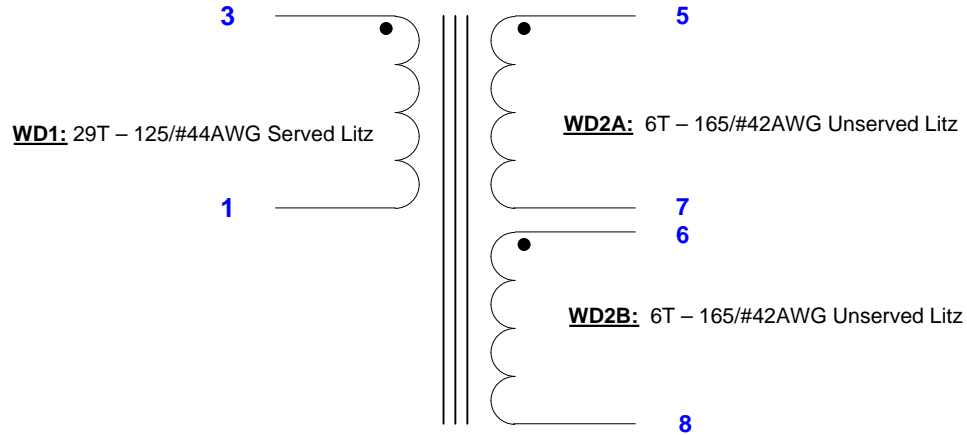


Figure 15 – LLC Transformer Schematic.

### 8.2.2 Electrical Specifications

<b>Electrical Strength</b>	1 second, 60 Hz, from pins 1-3 to pins 5-8.	3000 VAC
<b>Primary Inductance</b>	Pins 1-3, all other windings open, measured at 100 kHz, 0.4 V <sub>RMS</sub> .	340 μH ±10%
<b>Resonant Frequency</b>	Pins 2-5, all other windings open.	1800 kHz (Min)
<b>Primary Leakage Inductance</b>	Pins 1-5, with pins 5-8 shorted, measured at 100 kHz, 0.4 V <sub>RMS</sub> .	49 μH ±5%

### 8.2.3 Materials

Item	Description
[1]	Core Pair: Itacoil NFEV25A, PW4 material, gap for A <sub>LG</sub> of 404 nH/T <sup>2</sup> .
[2]	Bobbin: Itacoil RCEV25A.
[3]	Bobbin Cover, Itacoil GSEV25A.
[4]	Tape: Polyester Film, 3M 1350F-1 or equivalent, 12 mm wide.
[5]	Litz wire: 165/#42 Single Coated, Unserved.
[6]	Litz wire: 125/#44 Single Coated, Served.
[7]	Copper Tape, 3M-1181; or equivalent, 10 mm wide.
[8]	Wire, 20 AWG, Black, Stranded, UL 1015 Alpha 3073 BK or equivalent.

### 8.2.4 Build Diagram

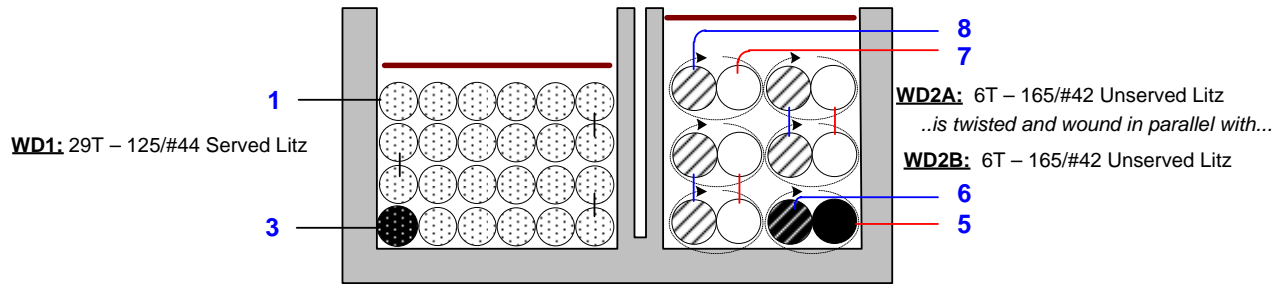


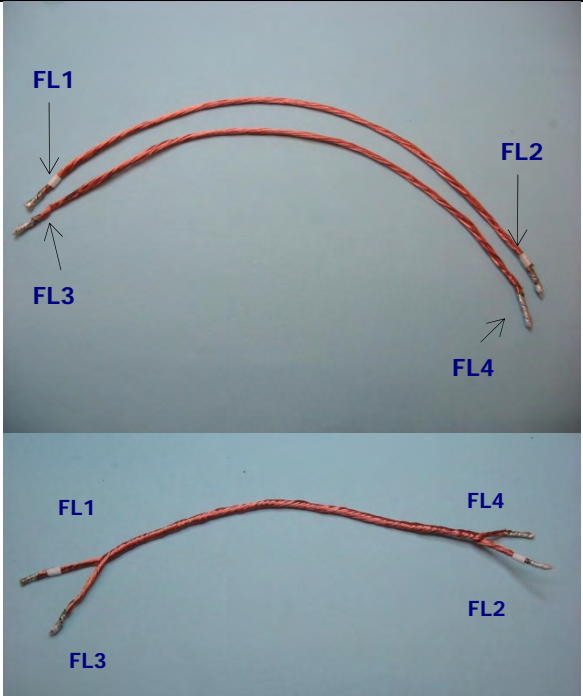
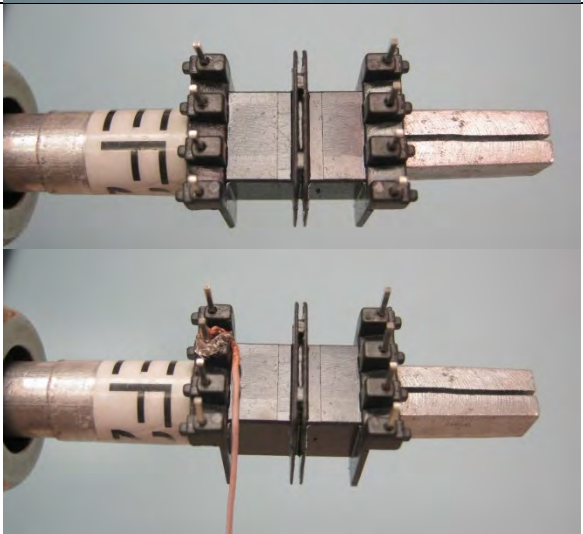
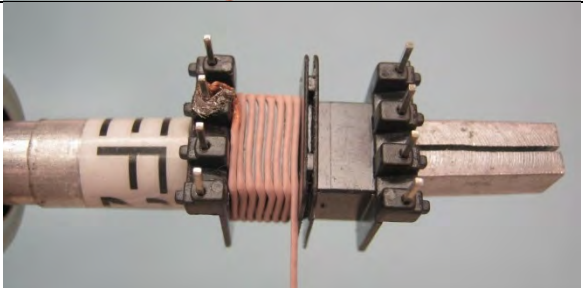
Figure 16 – LLC Transformer Build Diagram.

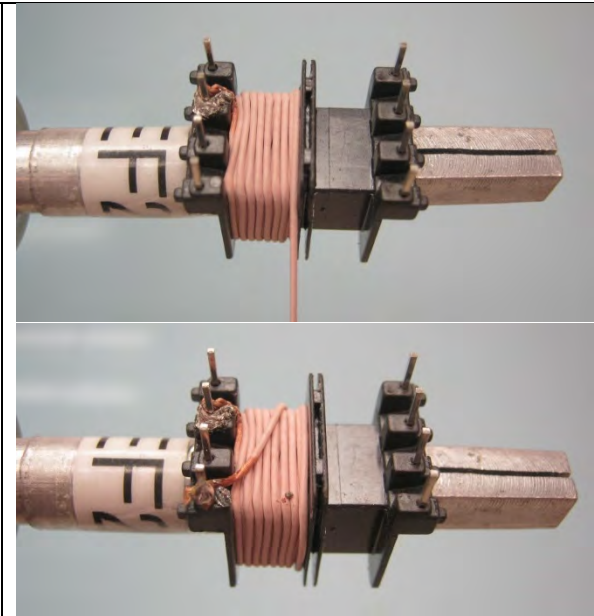
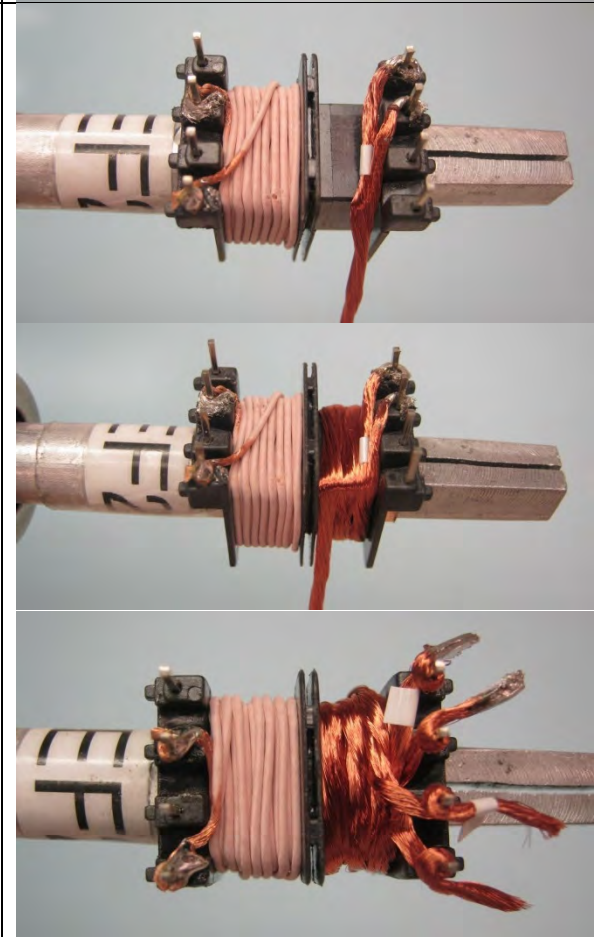
### 8.2.5 Winding Instructions

<b>Secondary Wire Preparation</b>	Prepare 2 strands of wire item [5] 12" length, tin ends. Label one strand to distinguish from other and designate it as FL1, FL2. Other strand will be designated as FL3 and FL4. Twist these 2 strands together ~20 twists evenly along length leaving 1" free at each end. See pictures below.
<b>WD1 (Primary)</b>	Place the bobbin item [2] on the mandrel with primary chamber on the left side. Note: primary chamber is wider than secondary chamber. Starting on pin 3, wind 29 turns of served Litz wire item [6] in 5 layers, and finish on Pin 1.
<b>WD2A &amp; WD2B (Secondary)</b>	Using unserved Litz assembly prepared in step 1, start with FL1 on pins 5 and FL3 on pin 6, tightly wind 6 turns in secondary chamber. Finish with FL2 on pin 6 and FL4 on pin 8.
<b>Bobbin Cover</b>	Slide bobbin cover [3] into grooves in bobbin flanges as shown. Make sure cover is securely seated.
<b>Finish</b>	Remove pins 2, 4 of bobbin. Grind core halves [1] for specified inductance. Assemble and secure core halves using circumferential turn of copper tape [7] as shown, overlap ends, and solder. Solder 3" termination lead of stranded wire item [8] to core band close to pin 4 as shown, secure with two turns of tape item [4].

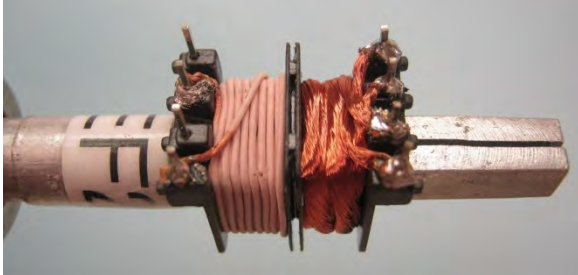
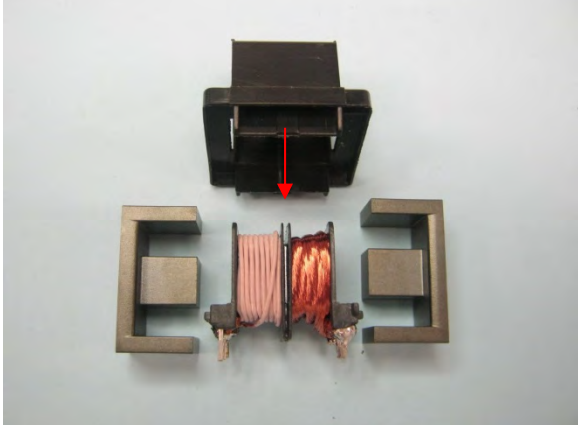



**8.2.6 Winding Illustrations**

<p><b>Secondary Wire Preparation</b></p>		<p>Prepare 2 strands of wire item [7] 12" length, tin ends. Label one strand to distinguish from other and designate it as FL1, FL2. Other strand will be designated as FL3 and FL4. Twist these 2 strands together ~20 twists evenly along length leaving 1" free at each end.</p>
<p><b>WD1 (Primary)</b></p>		<p>Place the bobbin item [2] on the mandrel with primary chamber on the left side. Note: primary chamber is wider than secondary chamber. Starting on pin 3,</p>
<p><b>WD1 (Primary) (Cont'd)</b></p>		<p>Wind 29 turns of served Litz wire item [6] in 5 layers, and finish on pin 1.</p>

		
<p><b>WD2A &amp; WD2B</b> <b>(Secondary)</b></p>		<p>Using unserved Litz assembly prepared in step 1, start with FL1 on pins 5 and FL3 on pin 6, tightly wind 6 turns in secondary chamber. Finish with FL2 on pin 6 and FL4 on pin 8.</p>



		
<p><b>Bobbin Cover</b></p>		<p>Slide bobbin cover [3] into grooves in bobbin flanges as shown. Make sure cover is securely seated.</p>
<p><b>Finish</b></p>		<p>Remove pins 2, 4 of bobbin. Grind core halves [1] for specified inductance. Assemble and secure core halves using circumferential turn of copper tape [7] as shown, overlap ends, and solder. Solder 3" termination lead of stranded wire item [8] to core band close to pin 4 as shown, secure with two turns of tape item [4].</p>



### 8.3 Output Inductor (L3) Specification

#### 8.3.1 Electrical Diagram

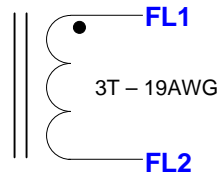


Figure 17 – Inductor Electrical Diagram.

#### 8.3.2 Electrical Specifications

<b>Inductance</b>	Pins FL1-FL2, all other windings open, measured at 100 kHz, 0.4 V <sub>RMS</sub> .	300 nH, ±15%
-------------------	--	--------------

#### 8.3.3 Material List

Item	Description
[1]	Powdered Iron Toroidal Core: Micrometals T30-26.
[2]	Magnet wire: #19 AWG Solderable Double Coated.

#### 8.3.4 Construction Details



Figure 16 – Finished Part, Front View. Tin Leads to within ~ 1/8" of Toroid Body.

## 9 PFC Design Spreadsheet

In this design, the spreadsheet generated warnings concerning the high value of KP selected, and for the operating current density of the Litz wire size selected for this design.

A high KP value can impact power factor and distortion, so a design generating this warning should be checked for any adverse impact. **This design met the requirements for power factor and harmonic distortion, and the high KP value allowed selection of a ferrite core for the PFC inductor, with consequent efficiency improvement.**

A warning for current density indicates that the design should be checked in its initial stages for excessive temperature rise in the PFC inductor. The guidelines incorporated the spreadsheet are conservative, so that a warning does not necessarily mean that a given design will fail thermally. **The measured temperature rise for this design was satisfactory.**

Hiper_PFS-II_Boost_062013; Rev.1.1; Copyright Power Integrations 2013	INPUT	INFO	OUTPUT	UNITS	Hiper_PFS-II_Boost_062013_Rev1-1.xls; Continuous Mode Boost Converter Design Spreadsheet
<b>Enter Applications Variables</b>					
Input Voltage Range			Universal		Input voltage range
VACMIN			90	V	Minimum AC input voltage
VACMAX			265	V	Maximum AC input voltage
VBROWNIN			76.69		Expected Minimum Brown-in Voltage
VBROWNOUT			68.33	V	Specify brownout voltage.
VO			385.00	V	Nominal Output voltage
PO	160.00		160.00	W	Nominal Output power
fL			50	Hz	Line frequency
TA Max			40	deg C	Maximum ambient temperature
n			0.93		Enter the efficiency estimate for the boost converter at VACMIN
KP	0.750	<i>Warning</i>	0.75		!!!Warning. KP is too high. Reduce KP to below 0.675 for Ferrite cores and to below 0.8 for other core types
VO_MIN			365.75	V	Minimum Output voltage
VO_RIPPLE_MAX			20	V	Maximum Output voltage ripple
tHOLDUP	18.00		18	ms	Holdup time
VHOLDUP_MIN			310	V	Minimum Voltage Output can drop to during holdup
I_INRUSH			40	A	Maximum allowable inrush current
Forced Air Cooling	no		no		Enter "Yes" for Forced air cooling. Otherwise enter "No"
<b>PFS Parameters</b>					
PFS Part Number	PFS7326H		PFS7326H		Selected PFS device
MODE	EFFICIENCY		EFFICIENCY		Mode of operation of PFS. For full mode enter "FULL" otherwise enter "EFFICIENCY" to indicate efficiency mode
R_RPIN			49.9	k-ohms	R pin resistor value



C_RPIN			1.00	nF	R pin capacitor value
IOCP min			6.80	A	Minimum Current limit
IOCP typ			7.20	A	Typical current limit
IOCP max			7.50	A	Maximum current limit
RDSON			0.62	ohms	Typical RDSon at 100 °C
RV1			1.50	Mohms	Line sense resistor 1
RV2			1.50	Mohms	Line sense resistor 2
RV3			1.00	Mohms	Line sense resistor 3
C_VCC			3.30	uF	Supply decoupling capacitor
R_VCC			15.00	ohms	VCC resistor
C_V			22.00	nF	V pin decoupling capacitor
C_C			22.00	nF	Feedback C pin decoupling capacitor
Power good Vo lower threshold VPG(L)			333.00	V	Power good Vo lower threshold voltage
PGT set resistor			103.79	kohm	Power good threshold setting resistor
FS_PK			60.2	kHz	Estimated frequency of operation at crest of input voltage (at VACMIN)
FS_AVG			50.2	kHz	Estimated average frequency of operation over line cycle (at VACMIN)
IP			3.97	A	MOSFET peak current
PFS_IRMS			1.67	A	PFS MOSFET RMS current
PCOND_LOSS_PFS			1.73	W	Estimated PFS conduction losses
PSW_LOSS_PFS			0.78	W	Estimated PFS switching losses
PFS_TOTAL			2.51	W	Total Estimated PFS losses
TJ Max			100	deg C	Maximum steady-state junction temperature
Rth-JS			3.00	degC/W	Maximum thermal resistance (Junction to heatsink)
HEATSINK Theta-CA			15.30	degC/W	Maximum thermal resistance of heatsink
<b>Basic Inductor Calculation</b>					
LPFC			437	uH	Value of PFC inductor at peak of VACMIN and Full Load
LPFC (0 Bias)			437	uH	Value of PFC inductor at No load. This is the value measured with LCR meter
LP_TOL	5.00		5	%	Tolerance of PFC Inductor Value
LPFC_RMS			1.97	A	Inductor RMS current (calculated at VACMIN and Full Load)
<b>Inductor Construction Parameters</b>					
Core Type	Ferrite		Ferrite		Enter "Sendust", "Pow Iron" or "Ferrite"
Core Material	Auto		PC44		Select from 60u, 75u, 90u or 125 u for Sendust cores. Fixed at PC44 or equivalent for Ferrite cores. Fixed at 52 material for Pow Iron cores.
Core Geometry	Auto		PQ		Select from Toroid or EE for Sendust cores and from EE, or PQ for Ferrite cores
Core	PQ32/20		PQ32/20		Core part number
AE			170	mm <sup>2</sup>	Core cross sectional area
LE			55.5	mm	Core mean path length
AL			6530	nH/t <sup>2</sup>	Core AL value
VE			9.44	cm <sup>3</sup>	Core volume
HT			5.12	mm	Core height/Height of window
MLT			67.1	cm	Mean length per turn
BW			8.98	mm	Bobbin width
NL			58		Inductor turns
LG			2.06	mm	Gap length (Ferrite cores only)
ILRMS			1.97	A	Inductor RMS current
Wire type	LITZ		LITZ		Select between "Litz" or "Regular" for double coated magnet wire

AWG	38		38	AWG	Inductor wire gauge
Filar	30		30		Inductor wire number of parallel strands
OD			0.102	mm	Outer diameter of single strand of wire
AC Resistance Ratio			1.01		Ratio of AC resistance to the DC resistance (using Dowell curves)
J		<i>Warning</i>	8.11	A/mm <sup>2</sup>	!!! Warning Current density is too high and may cause heating in the inductor wire. Reduce J
BP_TARGET			3500	Gauss	Target flux density at VACMIN (Ferrite cores only)
BM			1757	Gauss	Maximum operating flux density
BP			3487	Gauss	Peak Flux density (Estimated at VBROWNOUT)
LPFC_CORE_LOSS			0.09	W	Estimated Inductor core Loss
LPFC_COPPER_LOSS			1.80	W	Estimated Inductor copper losses
LPFC_TOTAL LOSS			1.89	W	Total estimated Inductor Losses
FIT			79.72%	%	Estimated FIT factor for inductor
Layers			5.1		Estimated layers in winding
<b>Critical Parameters</b>					
IRMS			1.91	A	AC input RMS current
IO_AVG			0.42	A	Output average current
<b>Output Diode (DO)</b>					
Part Number	Auto		INTERNAL		PFC Diode Part Number
Type			SPECIAL		Diode Type - Special - Diodes specially catered for PFC applications, SiC - Silicon Carbide type, UF - Ultrafast recovery type
Manufacturer			PI		Diode Manufacturer
VRRM			600	V	Diode rated reverse voltage
IF			3	A	Diode rated forward current
TRR			31	ns	Diode Reverse recovery time
VF			1.47	V	Diode rated forward voltage drop
PCOND_DIODE			0.61	W	Estimated Diode conduction losses
PSW_DIODE			0.16	W	Estimated Diode switching losses
P_DIODE			0.77	W	Total estimated Diode losses
TJ Max			100	deg C	Maximum steady-state operating temperature
Rth-JS			3.85	degC/W	Maximum thermal resistance (Junction to heatsink)
HEATSINK Theta-CA			15.30	degC/W	Maximum thermal resistance of heatsink
<b>Output Capacitor</b>					
CO	Auto		120.00	uF	Minimum value of Output capacitance
VO_RIPPLE_EXPECTED			11.9	V	Expected ripple voltage on Output with selected Output capacitor
T_HOLDUP_EXPECTED			19.5	ms	Expected holdup time with selected Output capacitor
ESR_LF			1.38	ohms	Low Frequency Capacitor ESR
ESR_HF			0.55	ohms	High Frequency Capacitor ESR
IC_RMS_LF			0.29	A	Low Frequency Capacitor RMS current
IC_RMS_HF			0.85	A	High Frequency Capacitor RMS current
CO_LF_LOSS			0.12	W	Estimated Low Frequency ESR loss in Output capacitor
CO_HF_LOSS			0.39	W	Estimated High frequency ESR loss in Output capacitor
Total CO LOSS			0.51	W	Total estimated losses in Output Capacitor
<b>Input Bridge (BR1) and Fuse (F1)</b>					
I <sup>2</sup> t Rating			8.43	A <sup>2</sup> s	Minimum I <sup>2</sup> t rating for fuse
Fuse Current rating			3.00	A	Minimum Current rating of fuse
VF			0.90	V	Input bridge Diode forward Diode drop
IAVG			1.86	A	Input average current at 70 VAC.





PIV_INPUT BRIDGE			375	V	Peak inverse voltage of input bridge
PCOND_LOSS_BRIDGE			3.10	W	Estimated Bridge Diode conduction loss
CIN			0.47	uF	Input capacitor. Use metallized polypropylene or film foil type with high ripple current rating
RT			9.37	ohms	Input Thermistor value
D_Precharge			1N5407		Recommended precharge Diode
<b>Feedback Components</b>					
R1			1.50	Mohms	Feedback network, first high voltage divider resistor
R3			1.60	Mohms	Feedback network, third high voltage divider resistor
R2			787.00	kohms	Feedback network, second high voltage divider resistor
C1			47.00	nF	Feedback network, loop speedup capacitor
R4			60.40	kohms	Feedback network, lower divider resistor
R6			487.00	kohms	Feedback network - pole setting resistor
R7			6.98	kohms	Feedback network - zero setting resistor
C2			47.00	nF	Feedback component- noise suppression capacitor
R5			3.00	kohms	Damping resistor in serise with C3
C3			2.20	uF	Feedback network - compensation capacitor
D1			BAV116		Feedback network - capacitor failure detection Diode
<b>Loss Budget (Estimated at VACMIN)</b>					
PFS Losses			2.51	W	Total estimated losses in PFS
Boost diode Losses			0.77	W	Total estimated losses in Output Diode
Input Bridge losses			3.10	W	Total estimated losses in input bridge module
Inductor losses			1.89	W	Total estimated losses in PFC choke
Output Capacitor Loss			0.51	W	Total estimated losses in Output capacitor
Total losses			8.78	W	Overall loss estimate
Efficiency			0.95		Estimated efficiency at VACMIN. Verify efficiency at other line voltages

## 10 LLC Transformer Design Spreadsheet

HiperLCS_040312; Rev.1.3; Copyright Power Integrations 2012		INPUTS	INFO	OUTPUTS	UNITS	HiperLCS_040312_Rev1-3.xls; HiperLCS Half-Bridge, Continuous mode LLC Resonant Converter Design Spreadsheet
<b>Enter Input Parameters</b>						
Vbulk_nom			380	V	Nominal LLC input voltage	
Vbrownout		287	287	V	Brownout threshold voltage. HiperLCS will shut down if voltage drops below this value. Allowable value is between 65% and 76% of Vbulk_nom. Set to 65% for max holdup time	
Vbrownin			362	V	Startup threshold on bulk capacitor	
VOV_shut			476	V	OV protection on bulk voltage	
VOV_restart			459	V	Restart voltage after OV protection.	
CBULK		120.00	120	uF	Minimum value of bulk cap to meet holdup time requirement; Adjust holdup time and Vbrownout to change bulk cap value	
tHOLDUP			23.8	ms	Bulk capacitor hold up time	
<b>Enter LLC (secondary) outputs</b>				<b>The spreadsheet assumes AC stacking of the secondaries</b>		
VO1		43.00	43.0	V	Main Output Voltage. Spreadsheet assumes that this is the regulated output	
IO1		3.50	3.5	A	Main output maximum current	
VD1		0.70	0.70	V	Forward voltage of diode in Main output	
PO1			151	W	Output Power from first LLC output	
VO2			0.0	V	Second Output Voltage	
IO2			0.0	A	Second output current	
VD2			0.70	V	Forward voltage of diode used in second output	
PO2			0.00	W	Output Power from second LLC output	
P_LLC			151	W	Specified LLC output power	
<b>LCS Device Selection</b>						
Device		LCS702	LCS702		LCS Device	
RDS-ON (MAX)			1.39	ohms	RDS-ON (max) of selected device	
Coss			250	pF	Equivalent Coss of selected device	
Cpri			40	pF	Stray Capacitance at transformer primary	
Pcond_loss			1.5	W	Conduction loss at nominal line and full load	
Tmax-hs			90	deg C	Maximum heatsink temperature	
Theta J-HS			9.1	deg C/W	Thermal resistance junction to heatsink (with grease and no insulator)	
Expected Junction temperature			103	deg C	Expected Junction temperature	
Ta max			50	deg C	Expected max ambient temperature	
Theta HS-A			27	deg C/W	Required thermal resistance heatsink to ambient	
<b>LLC Resonant Parameter and Transformer Calculations (generates red curve)</b>						
Vres_target		380	380	V	Desired Input voltage at which power train operates at resonance. If greater than Vbulk_nom, LLC operates below resonance at VBULK.	
Po			153	W	LLC output power including diode loss	
Vo			43.70	V	Main Output voltage (includes diode drop) for calculating Nsec and turns ratio	
f_target			250	kHz	Desired switching frequency at Vbulk_nom. 66 kHz to 300 kHz, recommended 180-250 kHz	
Lpar			291	uH	Parallel inductance. (Lpar = Lopen - Lres for integrated transformer; Lpar = Lmag for non-integrated low-leakage transformer)	
Lpri			341	uH	Primary open circuit inductance for integrated transformer; for low-leakage transformer it is sum of primary inductance and series inductor. If left blank, auto-calculation shows value necessary for slight loss of ZVS at ~80% of Vnom	
Lres		50.00	50.0	uH	Series inductance or primary leakage inductance of integrated transformer; if left blank auto-calculation is for K=4	



Kratio		5.8		Ratio of Lpar to Lres. Maintain value of K such that $2.1 < K < 11$ . Preferred Lres is such that $K < 7$ .
Cres	8.20	8.2	nF	Series resonant capacitor. Red background cells produce red graph. If Lpar, Lres, Cres, and n_RATIO_red_graph are left blank, they will be auto-calculated
Lsec		14.618	uH	Secondary side inductance of one phase of main output; measure and enter value, or adjust value until f_predicted matches what is measured ;
m		50	%	Leakage distribution factor (primary to secondary). >50% signifies most of the leakage is in primary side. Gap physically under secondary yields >50%, requiring fewer primary turns.
n_eq		4.47		Turns ratio of LLC equivalent circuit ideal transformer
Npri	29.0	29.0		Primary number of turns; if input is blank, default value is auto-calculation so that $f_{predicted} = f_{target}$ and $m=50\%$
Nsec	6.0	6.0		Secondary number of turns (each phase of Main output). Default value is estimate to maintain $BAC \leq 200$ mT, using selected core (below)
f_predicted		227	kHz	Expected frequency at nominal input voltage and full load; Heavily influenced by n_eq and primary turns
f_res		249	kHz	Series resonant frequency (defined by series inductance Lres and C)
f_brownout		155	kHz	Expected switching frequency at Vbrownout, full load. Set HiperLCS minimum frequency to this value.
f_par		95	kHz	Parallel resonant frequency (defined by Lpar + Lres and C)
f_inversion		135	kHz	LLC full load gain inversion frequency. Operation below this frequency results in operation in gain inversion region.
Vinversion		247	V	LLC full load gain inversion point input voltage
Vres_expected		390	V	
<b>RMS Currents and Voltages</b>				
IRMS_LLC_Primary		1.03	A	Primary winding RMS current at full load, Vbulk_nom and f_predicted
Winding 1 (Lower secondary Voltage) RMS current		2.8	A	Winding 1 (Lower secondary Voltage) RMS current
Lower Secondary Voltage Capacitor RMS current		1.8	A	Lower Secondary Voltage Capacitor RMS current
Winding 2 (Higher secondary Voltage) RMS current		0.0	A	Winding 2 (Higher secondary Voltage) RMS current
Higher Secondary Voltage Capacitor RMS current		0.0	A	Higher Secondary Voltage Capacitor RMS current
Cres_Vrms		88	V	Resonant capacitor AC RMS Voltage at full load and nominal input voltage
<b>Virtual Transformer Trial - (generates blue curve)</b>				
New primary turns		29.0		Trial transformer primary turns; default value is from resonant section
New secondary turns		6.0		Trial transformer secondary turns; default value is from resonant section
New Lpri		341	uH	Trial transformer open circuit inductance; default value is from resonant section
New Cres		8.2	nF	Trial value of series capacitor (if left blank calculated value chosen so f_res same as in main resonant section above)
New estimated Lres		50.0	uH	Trial transformer estimated Lres
New estimated Lpar		291	uH	Estimated value of Lpar for trial transformer
New estimated Lsec		14.618	uH	Estimated value of secondary leakage inductance
New Kratio		5.8		Ratio of Lpar to Lres for trial transformer
New equivalent circuit transformer turns ratio		4.47		Estimated effective transformer turns ratio
V powertrain inversion new		247	V	Input voltage at LLC full load gain inversion point
f_res_trial		249	kHz	New Series resonant frequency
f_predicted_trial		227	kHz	New nominal operating frequency
IRMS_LLC_Primary		1.03	A	Primary winding RMS current at full load and nominal input

				voltage (Vbulk) and f_predicted_trial
Winding 1 (Lower secondary Voltage) RMS current	2.7	A		RMS current through Output 1 winding, assuming half sinusoidal waveshape
Lower Secondary Voltage Capacitor RMS current	1.6	A		Lower Secondary Voltage Capacitor RMS current
Winding 2 (Higher secondary Voltage) RMS current	2.7	A		RMS current through Output 2 winding; Output 1 winding is AC stacked on top of Output 2 winding
Higher Secondary Voltage Capacitor RMS current	0.0	A		Higher Secondary Voltage Capacitor RMS current
Vres_expected_trial	390	V		Expected value of input voltage at which LLC operates at resonance.
<b>Transformer Core Calculations (Calculates From Resonant Parameter Section)</b>				
Transformer Core	Auto	EEL25		Transformer Core
Ae	0.76	0.76	cm^2	Enter transformer core cross-sectional area
Ve	5.35	5.35	cm^3	Enter the volume of core
Aw		107.9	mm^2	Area of window
Bw	15.50	15.5	mm	Total Width of Bobbin
Loss density		200.0	mW/cm^3	Enter the loss per unit volume at the switching frequency and BAC (Units same as kW/m^3)
MLT	5.20	5.2	cm	Mean length per turn
Nchambers	2	2		Number of Bobbin chambers
Wsep	1.60	1.6	mm	Winding separator distance (will result in loss of winding area)
Ploss		1.1	W	Estimated core loss
Bpkfmin		155	mT	First Quadrant peak flux density at minimum frequency.
BAC		211	mT	AC peak to peak flux density (calculated at f_predicted, Vbulk at full load)
<b>Primary Winding</b>				
Npri	29.0			Number of primary turns; determined in LLC resonant section
Primary gauge	44	AWG		Individual wire strand gauge used for primary winding
Equivalent Primary Metric Wire gauge	0.050	mm		Equivalent diameter of wire in metric units
Primary litz strands	125	125		Number of strands in Litz wire; for non-litz primary winding, set to 1
Primary Winding Allocation Factor	50	%		Primary window allocation factor - percentage of winding space allocated to primary
AW_P	48	mm^2		Winding window area for primary
Fill Factor	25%	%		% Fill factor for primary winding (typical max fill is 60%)
Resistivity_25 C_Primary	75.42	m-ohm/m		Resistivity in milli-ohms per meter
Primary DCR 25 C	113.73	m-ohm		Estimated resistance at 25 C
Primary DCR 100 C	152.40	m-ohm		Estimated resistance at 100 C (approximately 33% higher than at 25 C)
Primary RMS current	1.03	A		Measured RMS current through the primary winding
ACR_Trif_Primary	259.81	m-ohm		Measured AC resistance (at 100 kHz, room temperature), multiply by 1.33 to approximate 100 C winding temperature
Primary copper loss	0.27	W		Total primary winding copper loss at 85 C
Primary Layers	3.02			Number of layers in primary Winding
<b>Secondary Winding 1 (Lower secondary voltage OR Single output)</b>			<b>Note - Power loss calculations are for each winding half of secondary</b>	
Output Voltage	43.00	V		Output Voltage (assumes AC stacked windings)
Sec 1 Turns	6.00			Secondary winding turns (each phase )
Sec 1 RMS current (total, AC+DC)	2.8	A		RMS current through Output 1 winding, assuming half sinusoidal waveshape
Winding current (DC component)	1.75	A		DC component of winding current
Winding current (AC RMS component)	2.17	A		AC component of winding current
Sec 1 Wire gauge	42	AWG		Individual wire strand gauge used for secondary winding
Equivalent secondary 1 Metric Wire gauge	0.060	mm		Equivalent diameter of wire in metric units
Sec 1 litz strands	165	165		Number of strands used in Litz wire; for non-litz non-integrated transformer set to 1



Resistivity_25 C_sec1	35.93	m-ohm/m	Resistivity in milli-ohms per meter
DCR_25C_Sec1	11.21	m-ohm	Estimated resistance per phase at 25 C (for reference)
DCR_100C_Sec1	15.02	m-ohm	Estimated resistance per phase at 100 C (approximately 33% higher than at 25 C)
DCR_Ploss_Sec1	0.37	W	Estimated Power loss due to DC resistance (both secondary phases)
ACR_Sec1	15.25	m-ohm	Measured AC resistance per phase (at 100 kHz, room temperature), multiply by 1.33 to approximate 100 C winding temperature. Default value of ACR is twice the DCR value at 100 C
ACR_Ploss_Sec1	0.14	W	Estimated AC copper loss (both secondary phases)
Total winding 1 Copper Losses	0.51	W	Total (AC + DC) winding copper loss for both secondary phases
Capacitor RMS current	1.8	A	Output capacitor RMS current
Co1	1.8	uF	Secondary 1 output capacitor
Capacitor ripple voltage	3.0	%	Peak to Peak ripple voltage on secondary 1 output capacitor
Output rectifier RMS Current	2.8	A	Schottky losses are a stronger function of load DC current. Sync Rectifier losses are a function of RMS current
Secondary 1 Layers	1.00		Number of layers in secondary 1 Winding
<b>Secondary Winding 2 (Higher secondary voltage)</b>			<b>Note - Power loss calculations are for each winding half of secondary</b>
Output Voltage	0.00	V	Output Voltage (assumes AC stacked windings)
Sec 2 Turns	0.00		Secondary winding turns (each phase) AC stacked on top of secondary winding 1
Sec 2 RMS current (total, AC+DC)	2.8	A	RMS current through Output 2 winding; Output 1 winding is AC stacked on top of Output 2 winding
Winding current (DC component)	0.0	A	DC component of winding current
Winding current (AC RMS component)	0.0	A	AC component of winding current
Sec 2 Wire gauge	42	AWG	Individual wire strand gauge used for secondary winding
Equivalent secondary 2 Metric Wire gauge	0.060	mm	Equivalent diameter of wire in metric units
Sec 2 litz strands	0		Number of strands used in Litz wire; for non-litz non-integrated transformer set to 1
Resistivity_25 C_sec2	59292.53	m-ohm/m	Resistivity in milli-ohms per meter
Transformer Secondary MLT	5.20	cm	Mean length per turn
DCR_25C_Sec2	0.00	m-ohm	Estimated resistance per phase at 25 C (for reference)
DCR_100C_Sec2	0.00	m-ohm	Estimated resistance per phase at 100 C (approximately 33% higher than at 25 C)
DCR_Ploss_Sec1	0.00	W	Estimated Power loss due to DC resistance (both secondary halves)
ACR_Sec2	0.00	m-ohm	Measured AC resistance per phase (at 100 kHz, room temperature), multiply by 1.33 to approximate 100 C winding temperature. Default value of ACR is twice the DCR value at 100 C
ACR_Ploss_Sec2	0.00	W	Estimated AC copper loss (both secondary halves)
Total winding 2 Copper Losses	0.00	W	Total (AC + DC) winding copper loss for both secondary halves
Capacitor RMS current	0.0	A	Output capacitor RMS current
Co2	N/A	uF	Secondary 2 output capacitor
Capacitor ripple voltage	N/A	%	Peak to Peak ripple voltage on secondary 1 output capacitor
Output rectifier RMS Current	0.0	A	Schottky losses are a stronger function of load DC current. Sync Rectifier losses are a function of RMS current
Secondary 2 Layers	1.00		Number of layers in secondary 2 Winding
Transformer Loss Calculations			Does not include fringing flux loss from gap
Primary copper loss (from Primary section)	0.27	W	Total primary winding copper loss at 85 C
Secondary copper Loss	0.51	W	Total copper loss in secondary winding
Transformer total copper loss	0.78	W	Total copper loss in transformer (primary + secondary)
AW_S	48.38	mm^2	Area of window for secondary winding
Secondary Fill Factor	19%	%	% Fill factor for secondary windings; typical max fill is 60% for served and 75% for unserved Litz

Signal Pins Resistor Values				
f_min	155	kHz	Minimum frequency when optocoupler is cut-off. Only change this variable based on actual bench measurements	
Dead Time	320	ns	Dead time	
Burst Mode	1	1	Select Burst Mode: 1, 2, and 3 have hysteresis and have different frequency thresholds	
f_max	847	kHz	Max internal clock frequency, dependent on dead-time setting. Is also start-up frequency	
f_burst_start	382	kHz	Lower threshold frequency of burst mode, provides hysteresis. This is switching frequency at restart after a bursting off-period	
f_burst_stop	437	kHz	Upper threshold frequency of burst mode; This is switching frequency at which a bursting off-period stops	
DT/BF pin upper divider resistor	6.79	k-ohms	Resistor from DT/BF pin to VREF pin	
DT/BF pin lower divider resistor	129	k-ohms	Resistor from DT/BF pin to G pin	
Rstart	5.79	k-ohms	Start-up resistor - resistor in series with soft-start capacitor; equivalent resistance from FB to VREF pins at startup. Use default value unless additional start-up delay is desired.	
Start up delay	0.0	ms	Start-up delay; delay before switching begins. Reduce R_START to increase delay	
Rfmin	46.2	k-ohms	Resistor from VREF pin to FB pin, to set min operating frequency; This resistor plus Rstart determine f_MIN. Includes 7% HiperLCS frequency tolerance to ensure f_min is below f_brownout	
C_softstart	0.33	uF	Softstart capacitor. Recommended values are between 0.1 uF and 0.47 uF	
Ropto	1.2	k-ohms	Resistor in series with opto emitter	
OV/UV pin lower resistor	19.60	19.6	k-ohm	Lower resistor in OV/UV pin divider
OV/UV pin upper resistor	2.93	M-ohm	Total upper resistance in OV/UV pin divider	
LLC Capacitive Divider Current Sense Circuit				
Slow current limit	2.35	A	8-cycle current limit - check positive half-cycles during brownout and startup	
Fast current limit	4.24	A	1-cycle current limit - check positive half-cycles during startup	
LLC sense capacitor	47	pF	HV sense capacitor, forms current divider with main resonant capacitor	
RLLC sense resistor	37.3	ohms	LLC current sense resistor, senses current in sense capacitor	
IS pin current limit resistor	220	ohms	Limits current from sense resistor into IS pin when voltage on sense R is < -0.5V	
IS pin noise filter capacitor	1.0	nF	IS pin bypass capacitor; forms a pole with IS pin current limit capacitor	
IS pin noise filter pole frequency	724	kHz	This pole attenuates IS pin signal	
Loss Budget				
LCS device Conduction loss	1.5	W	Conduction loss at nominal line and full load	
Output diode Loss	2.5	W	Estimated diode losses	
Transformer estimated total copper loss	0.78	W	Total copper loss in transformer (primary + secondary)	
Transformer estimated total core loss	1.1	W	Estimated core loss	
Total transformer losses	1.9	W	Total transformer losses	
Total estimated losses	5.8	W	Total losses in LLC stage	
Estimated Efficiency	96%	%	Estimated efficiency	
PIN	156	W	LLC input power	



# 11 Heat Sinks

## 11.1 Primary Heat Sink

### 11.1.1 Primary Heat Sink Sheet Metal

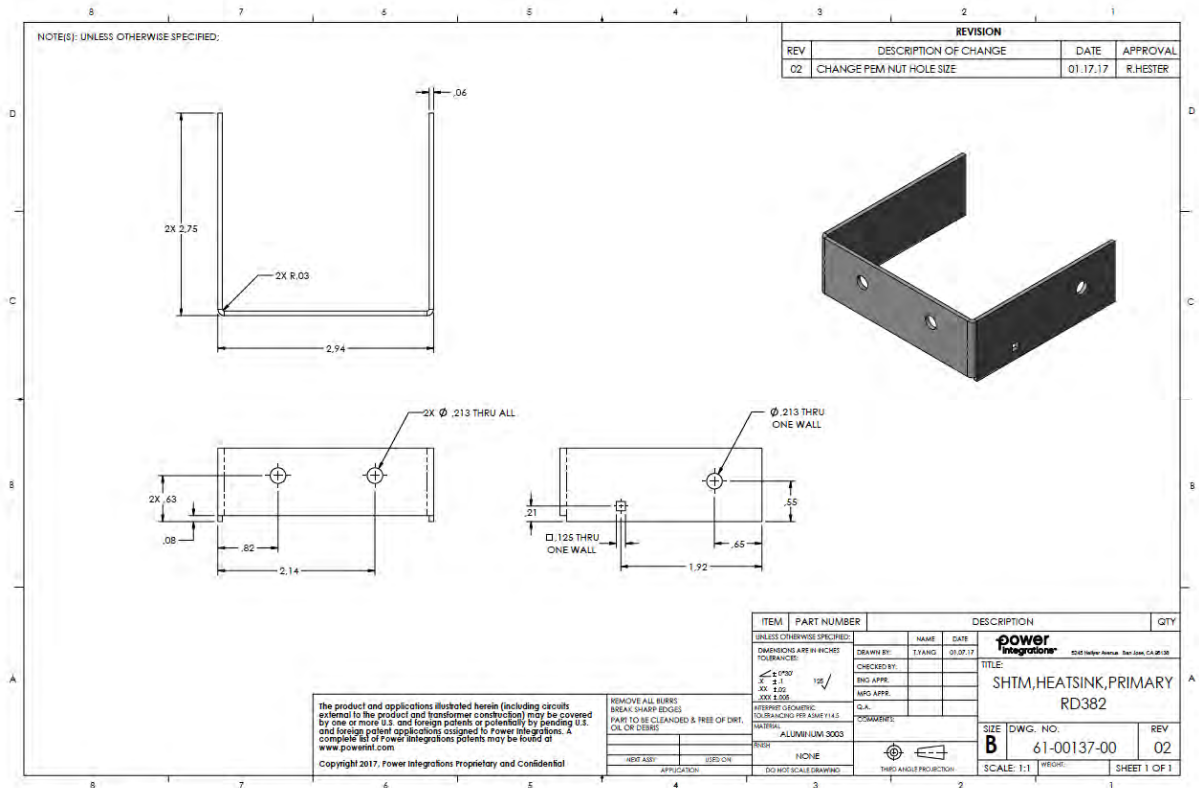


Figure 18 – RD-382 Primary Heat Sink Sheet Metal Drawing.



11.1.2 Primary Heat Sink with Fasteners

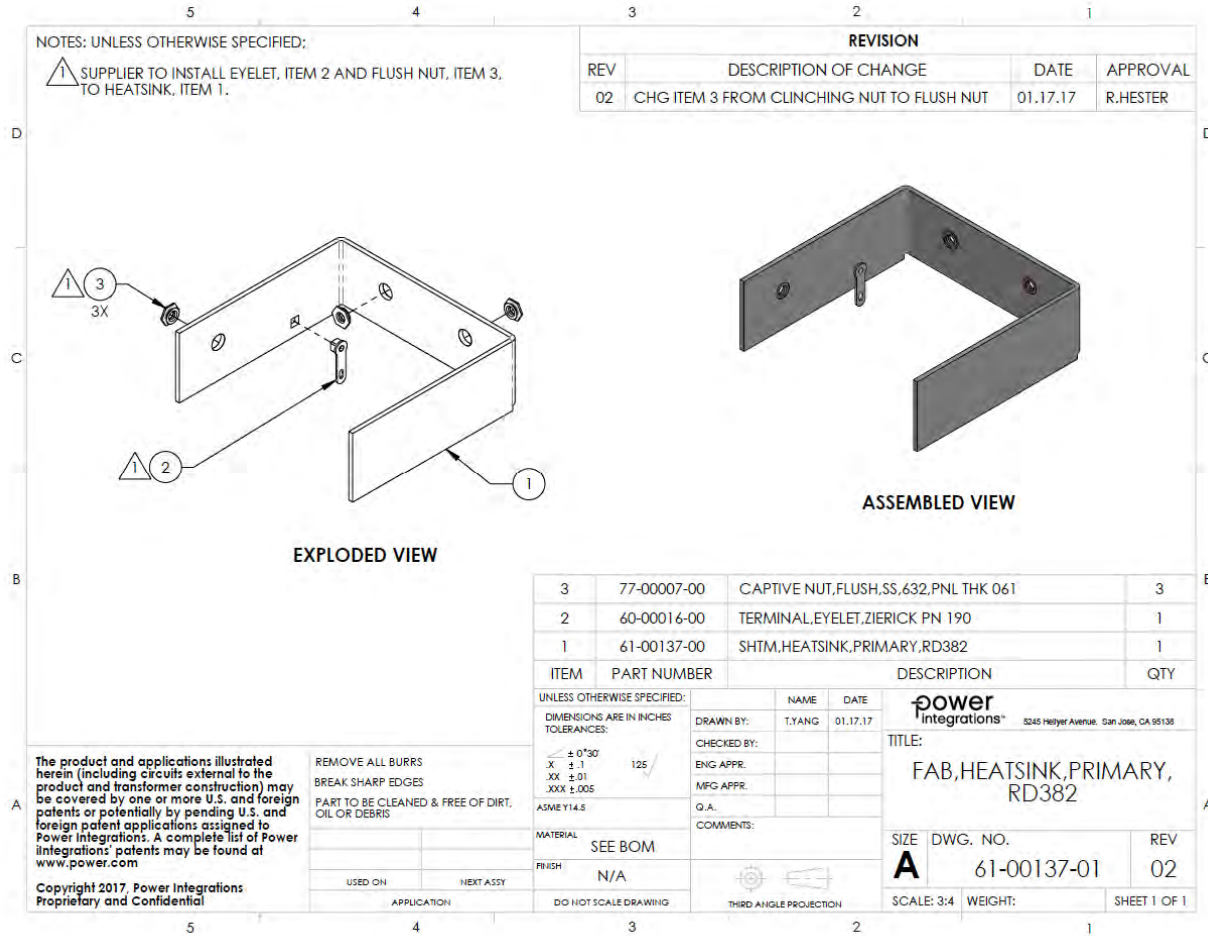


Figure 19 – Finished Primary Heat Sink Drawing with Installed Fasteners.



### 11.1.3 Primary Heat Sink Assembly

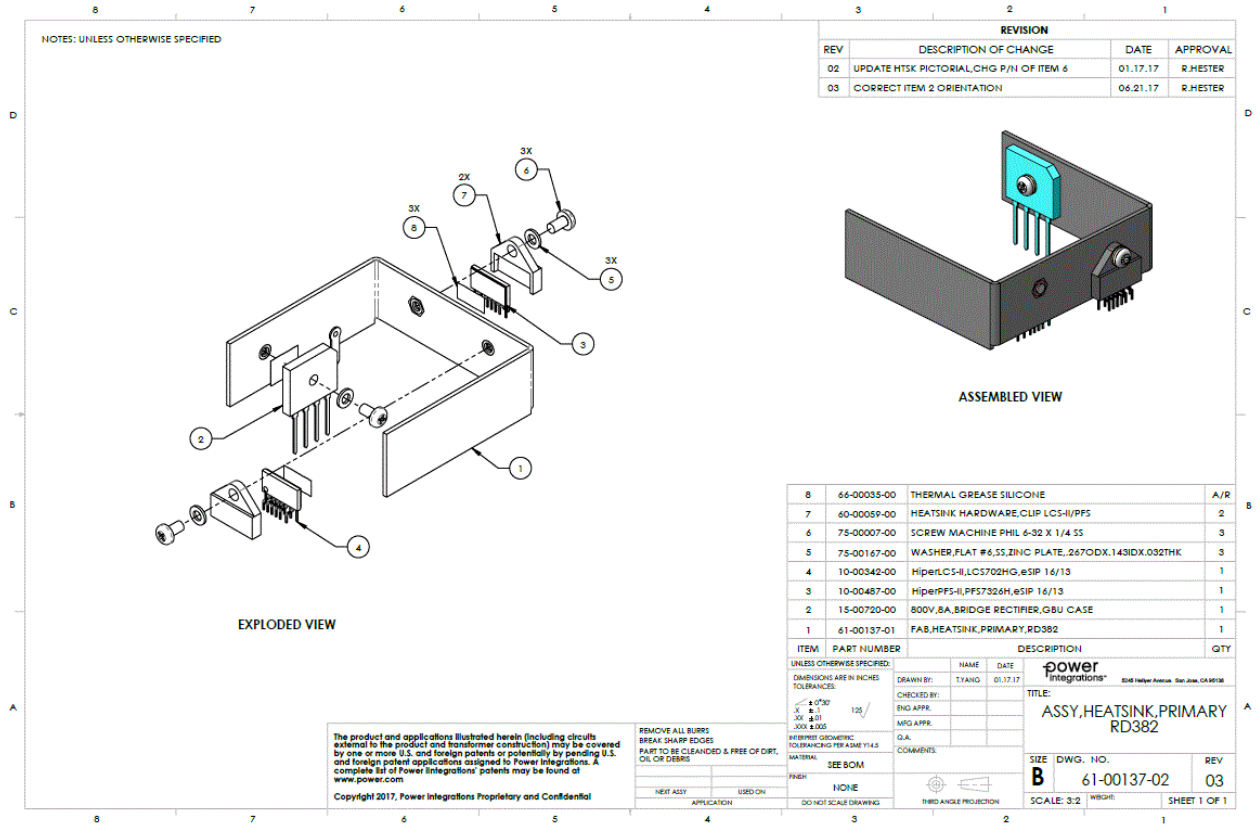


Figure 20 – RD-382 Primary Heat Sink Assembly.



### 11.2 Secondary Heat Sink

#### 11.2.1 Secondary Heat Sink Sheet Metal

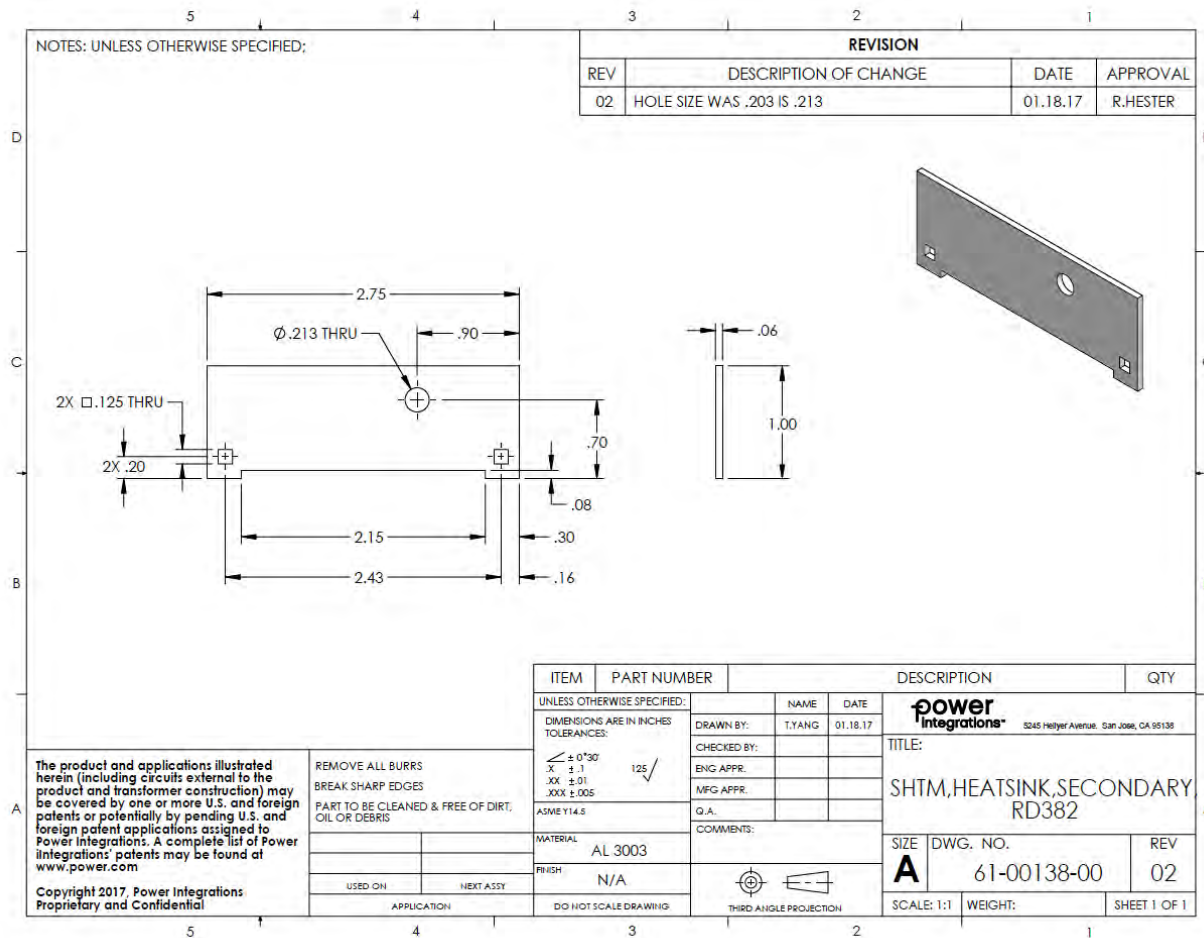


Figure 21 – Secondary Heat Sink Sheet Metal Drawing.

### 11.2.2 Secondary Heat Sink with Fasteners

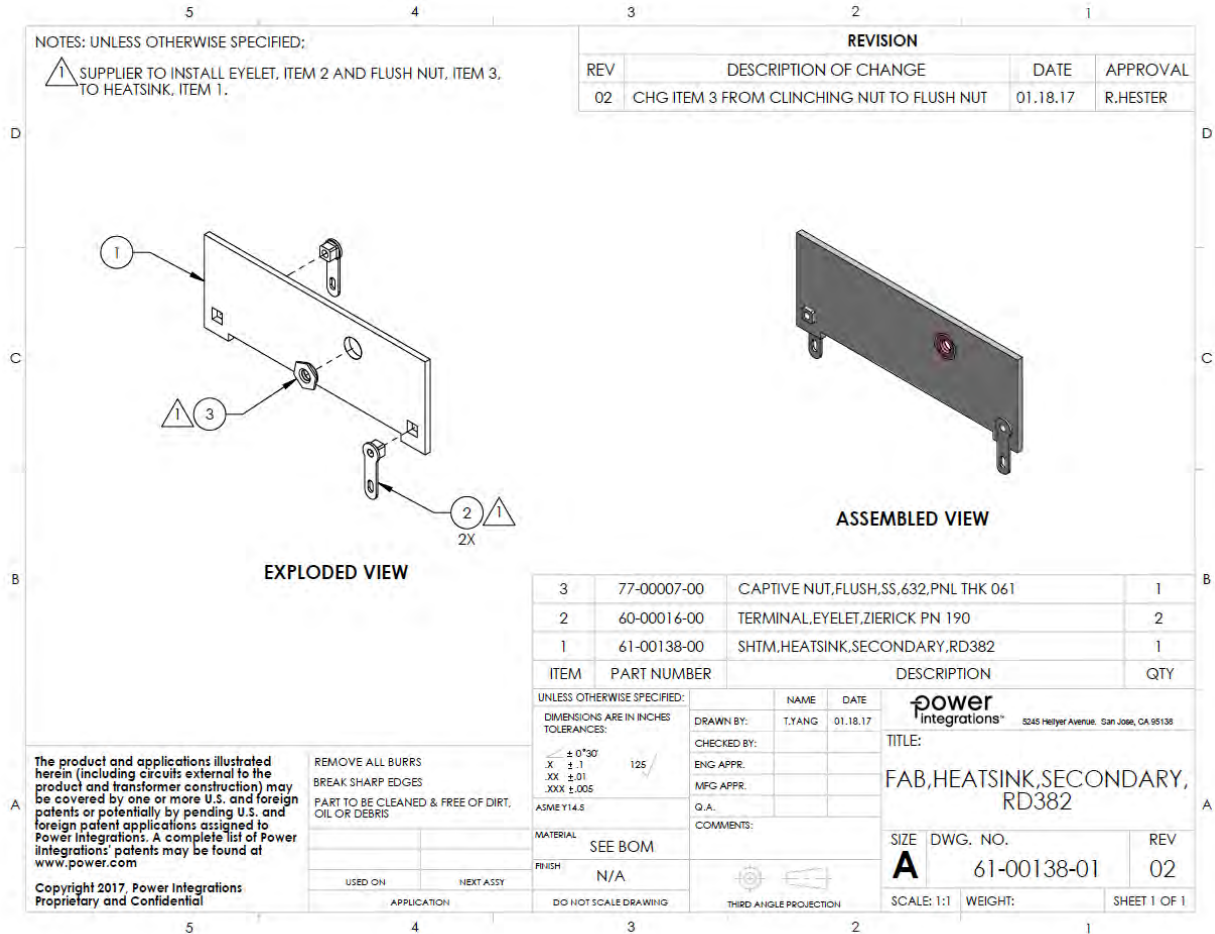


Figure 22 – Finished Secondary Heat Sink with Installed Fasteners.



### 11.2.3 Secondary Heat Sink Assembly

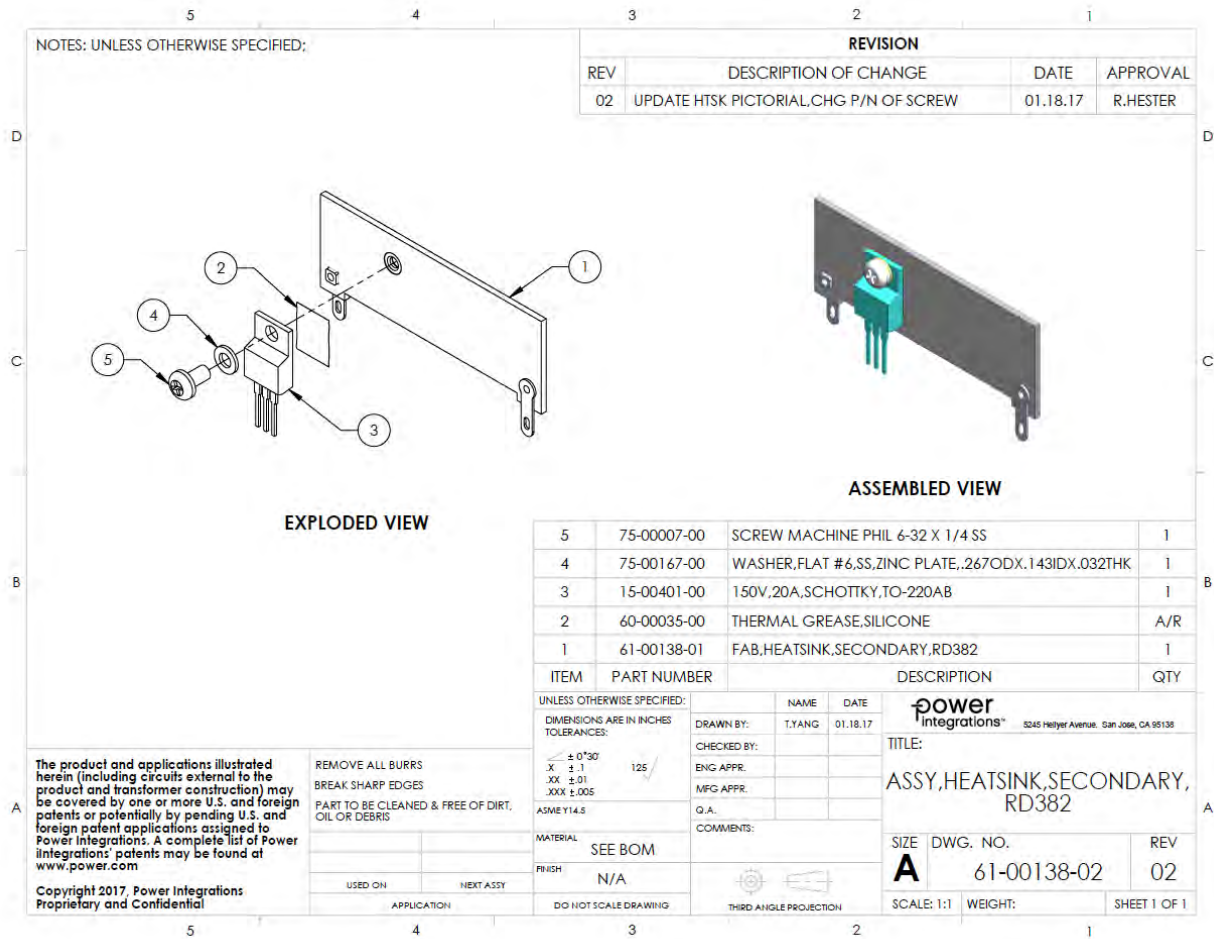


Figure 23 – RD-382 Secondary Heat Sink Assembly.



## 12 RD-382 Performance Data

All measurements were taken at room temperature and 60 Hz (input frequency) unless otherwise specified. Output voltage measurements were taken at the output connectors.

### 12.1 LLC Stage Efficiency

To make this measurement, the LLC stage was supplied by connecting an external 380 VDC source across bulk capacitor C14, with a 2-channel bench supply to source the primary and secondary bias voltages. The output of the supply was used to power the LED streetlight described in Section 7, and the dimming input of the supply was used to program the current delivered to this load in order to vary the output power.

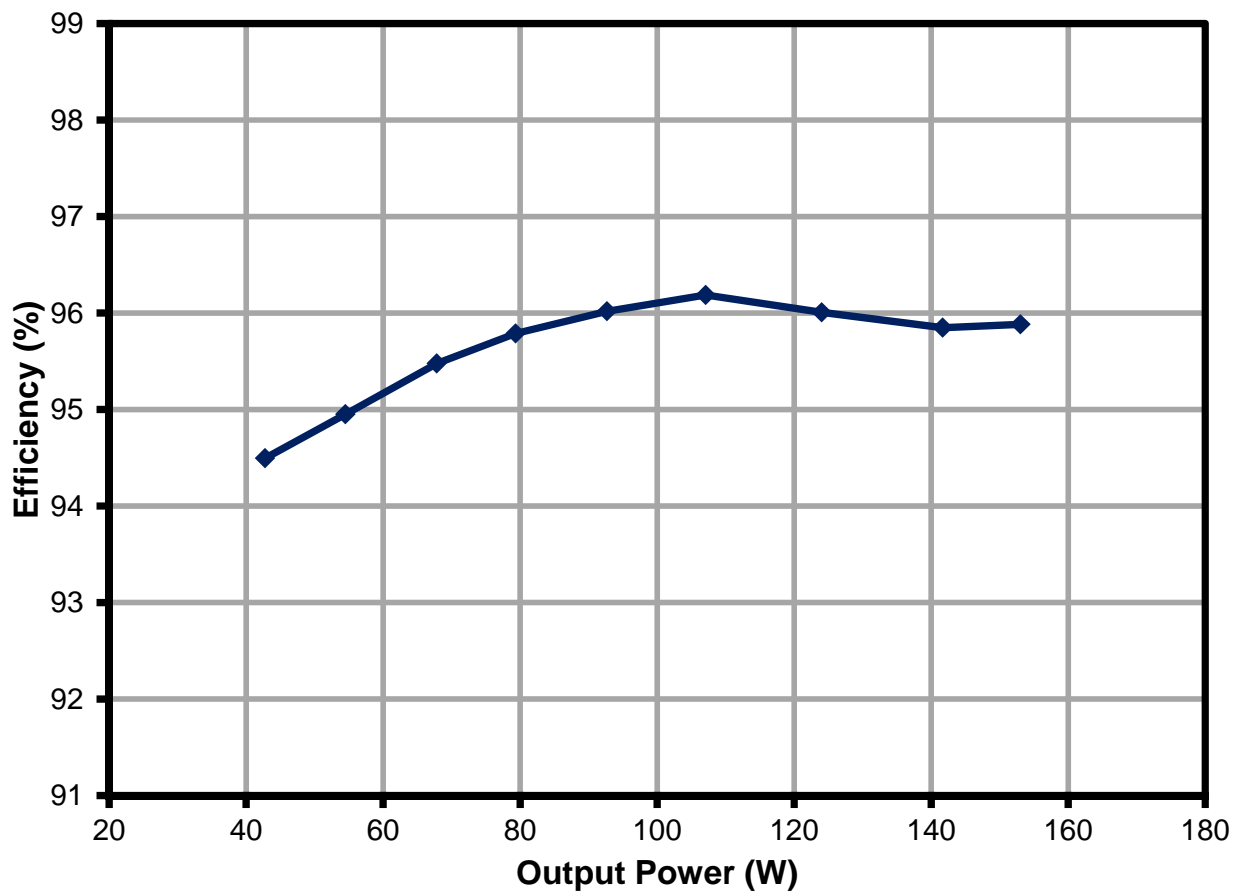


Figure 24 – LLC Stage Efficiency vs. Load, 380 VDC Input.

### 12.2 Total Efficiency

Figures below show the total supply efficiency (PFC and LLC stages). AC input was supplied using a sine wave source. The output was loaded with an electronic load set for constant resistance, with the load adjusted for maximum output current (3.5 A) and 43 V output voltage.

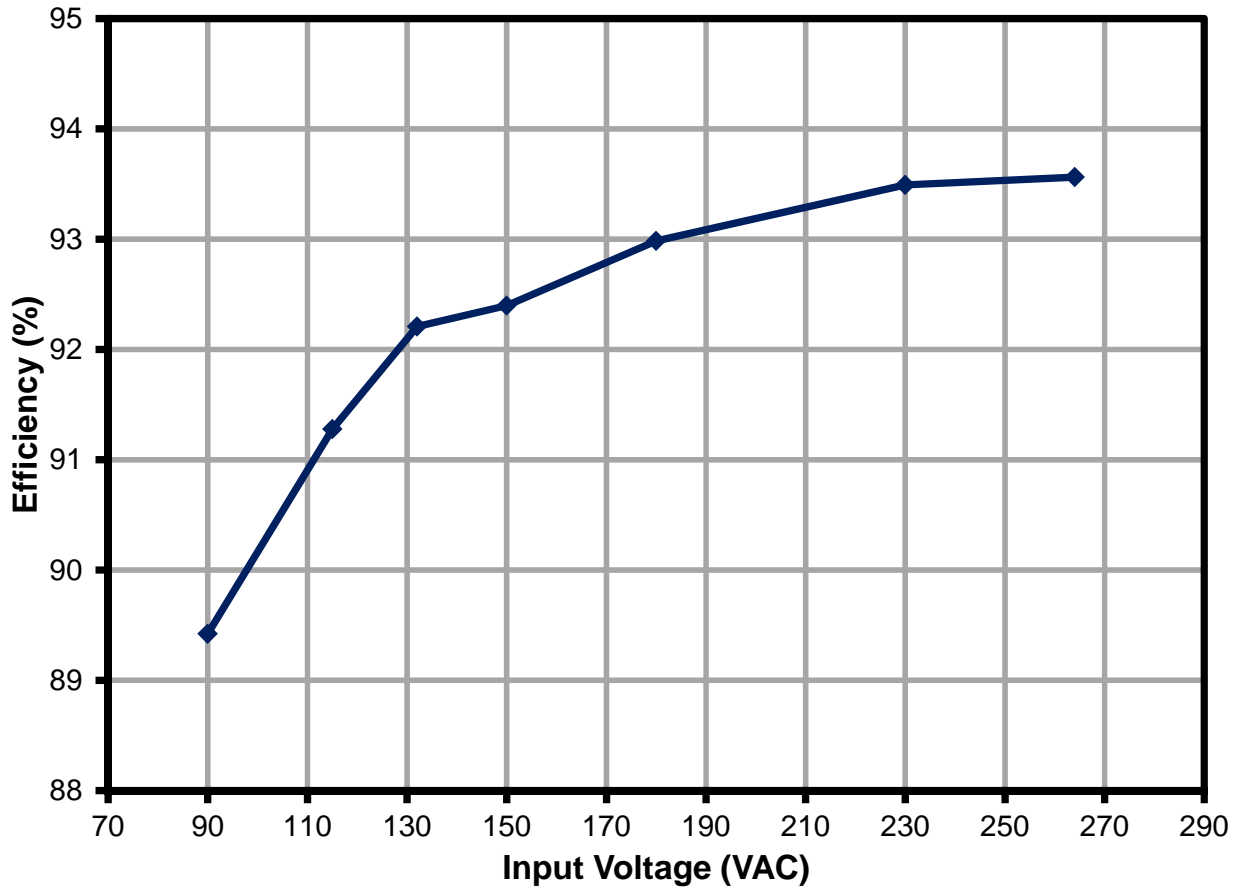


Figure 25 – Total Efficiency vs. Input Voltage, 100% Load.

### 12.3 Power Factor

Power factor measurements were made using a sine wave AC source and a constant resistance electronic load as described in section 12.2.

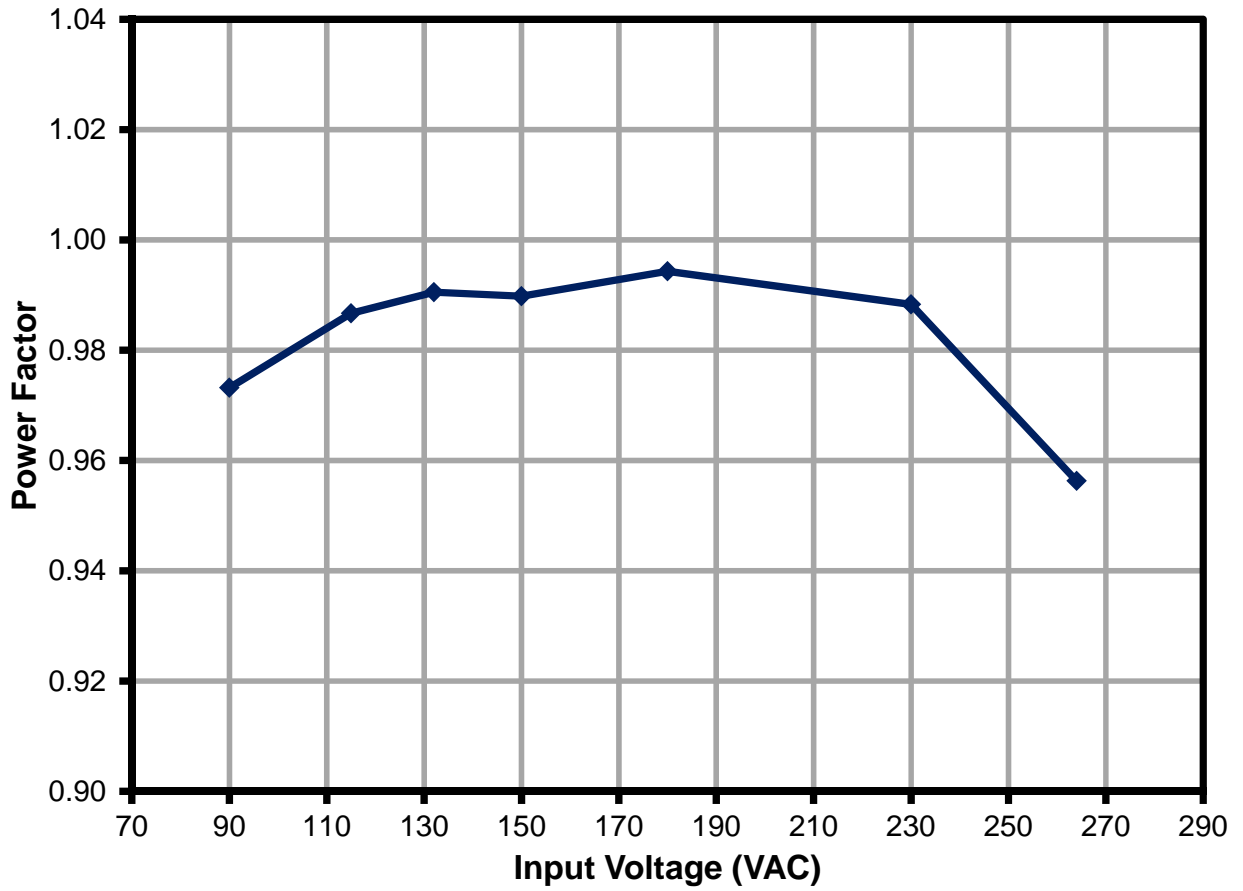


Figure 26 – Power Factor vs. Input Voltage, 100% Load.



**12.4 Harmonic Distribution**

Input current harmonic distribution was measured using a sine wave source and an LED load (Section 7).

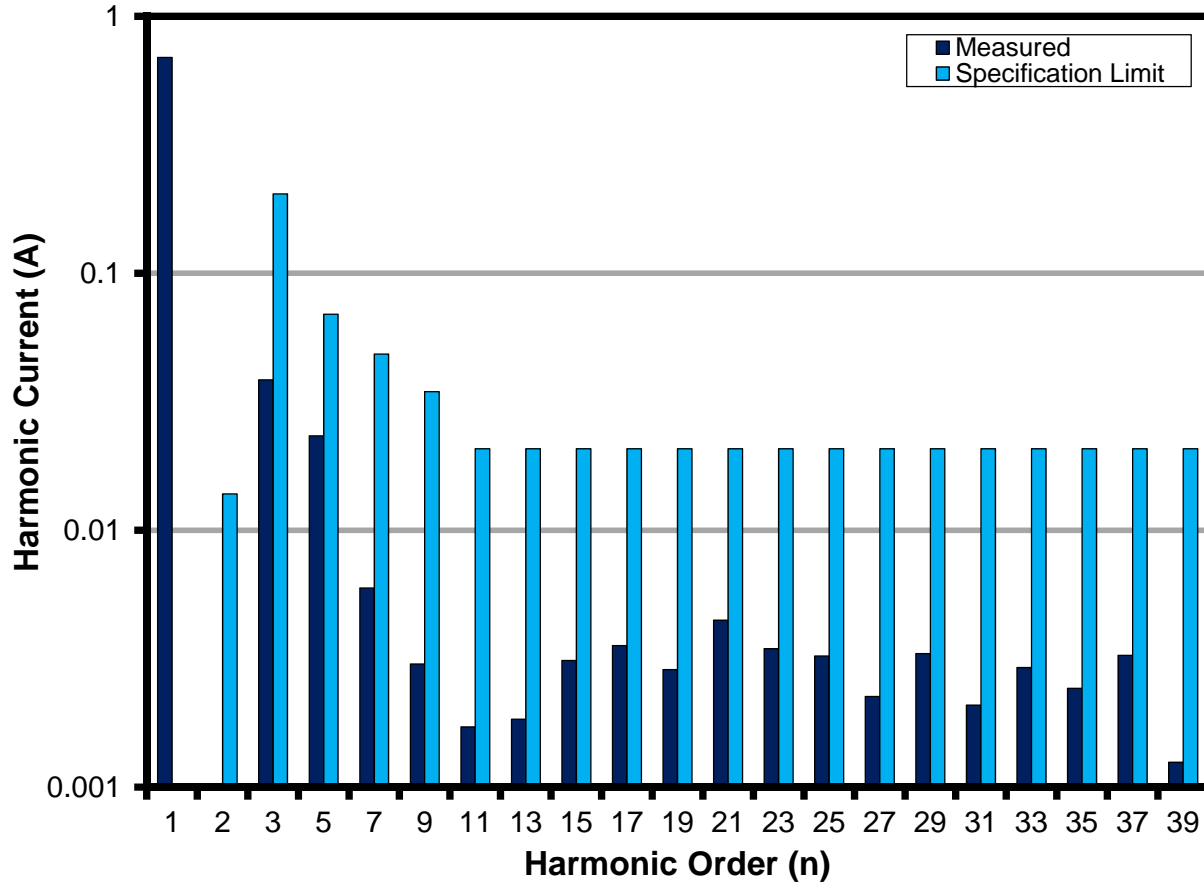


Figure 27 – Input Current Harmonic Distribution, 230 VAC / 50 Hz Input, 100% Load.

**12.5 THD, 100% Load**

THD was measured using the LED streetlight load described in Section 7 of this report.

Input Voltage (VAC)	Frequency (Hz)	THD (%)
115	60	8.30
230	50	7.38





### 12.6 Output Current vs. Dimming Input Voltage

Output dimming characteristics were measured using a sine wave AC source and the streetlight LED array described in Section 7. Dimming voltage was provided using a bench supply.

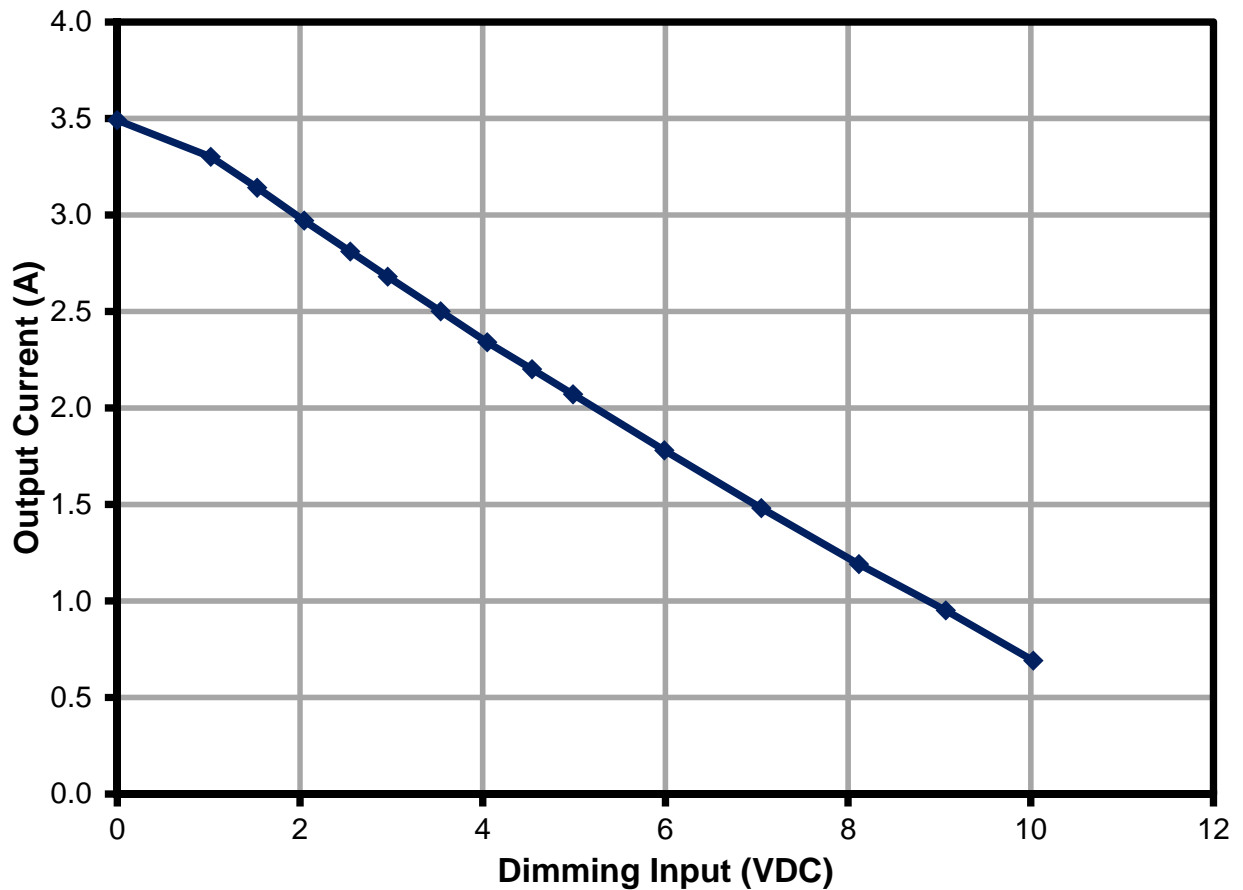


Figure 28 – RD-382 Output Current vs. Dimming Voltage.

### 13 Waveforms

#### 13.1 Input Current, 100% Load

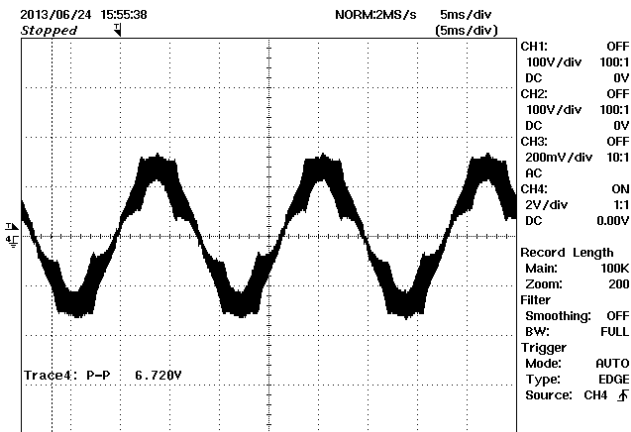


Figure 29 – Input Current, 90 VAC, 150 W Load, 2 A, 5 ms / div

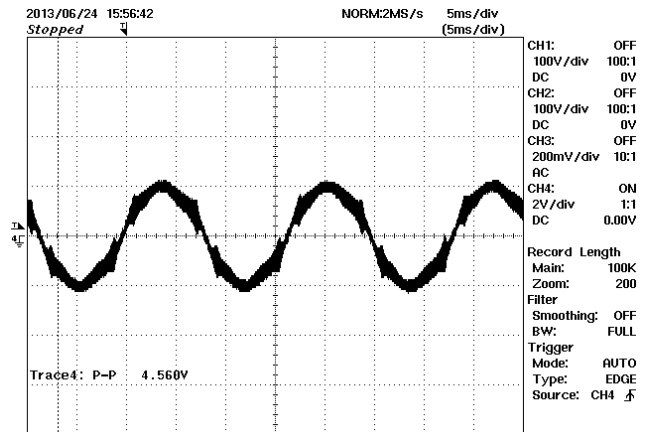


Figure 30 – Input Current, 115 VAC, 150 W Load, 2 A, 5 ms / div.

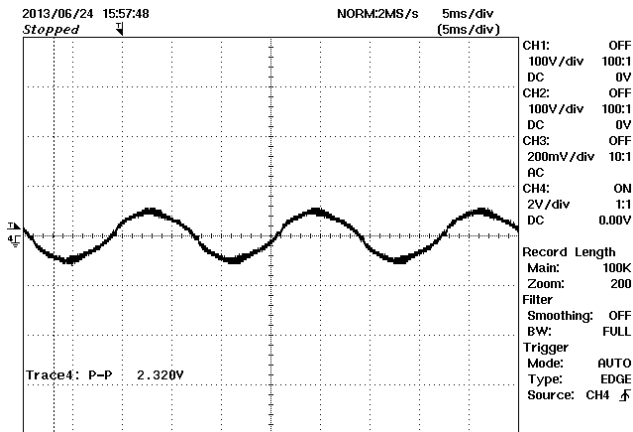


Figure 31 – Input Current, 230 VAC, 150 W Load, 2 A, 5 ms / div.

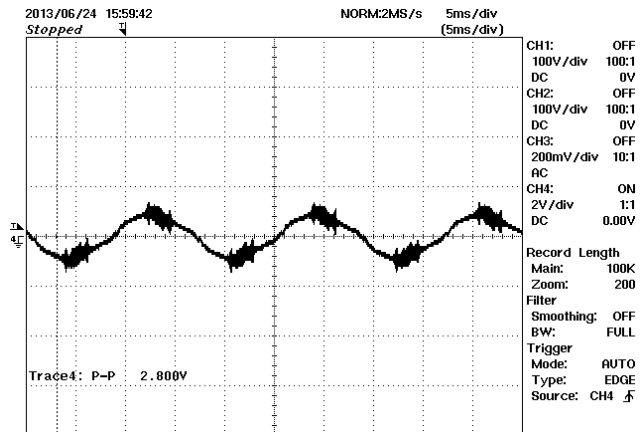
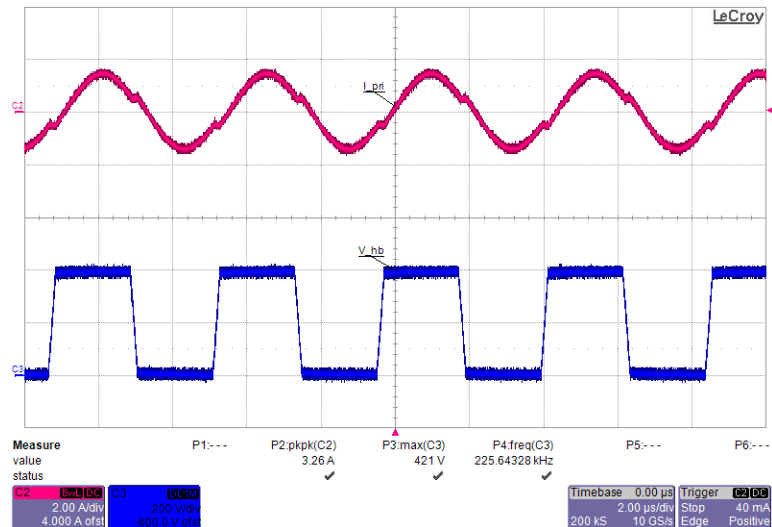


Figure 32 – Input Current, 265 VAC, 150 W Load, 2 A, 5 ms / div.

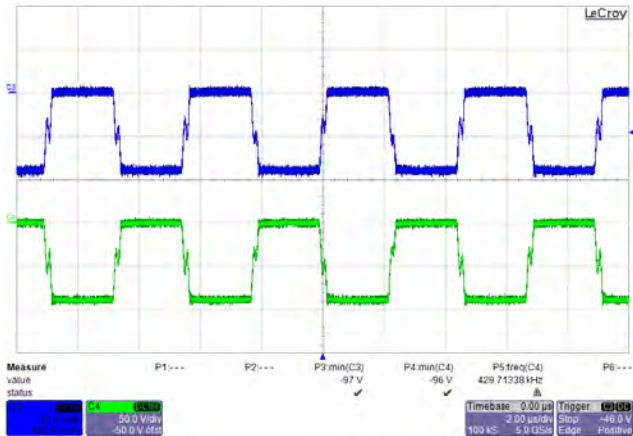
### 13.2 LLC Primary Voltage and Current

The LLC stage current was measured by inserting a current sensing loop in series with the ground side of resonating capacitor C30 that measures the LLC transformer (T2) primary current. The output was loaded with an electronic load set for constant resistance, with the load adjusted for maximum output current and 43 V output voltage.

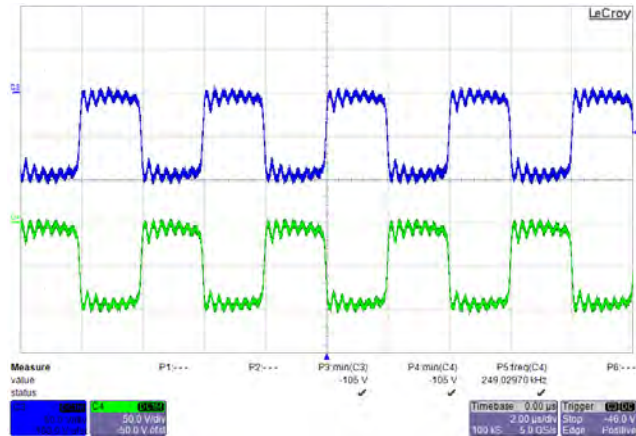


**Figure 33** — LLC Stage Primary Voltage and Current, 100% Load.  
Upper: Current, 2 A / div.  
Lower: Voltage, 200 V, 2 μs / div.

### 13.3 Output Rectifier Peak Reverse Voltage



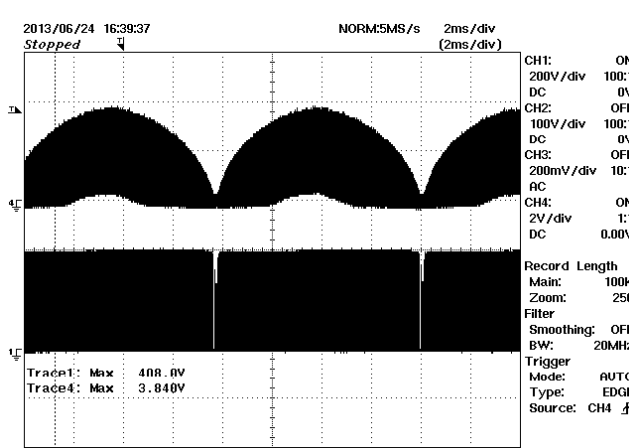
**Figure 34** – Output Rectifier (D11) Reverse Voltage, 100% Load. Top and Bottom Traces Show Voltages on Each Half of D11, at 50 V, 2  $\mu$ s / div.



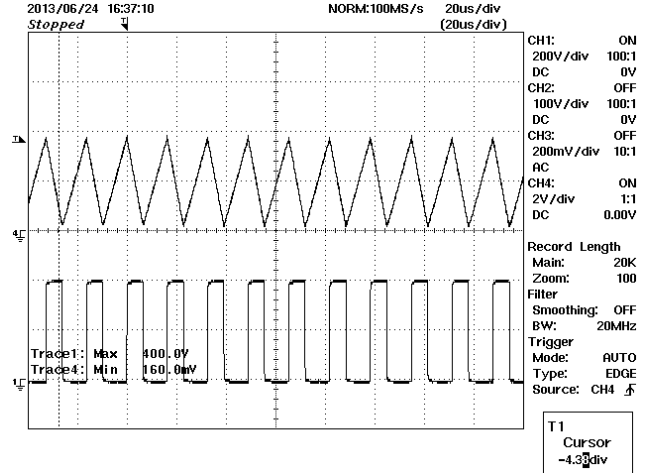
**Figure 35** – Output Rectifier (D11) Reverse Voltage, No-Load. Top and Bottom Traces Show Voltages on Each Half of D11, at 50 V, 2  $\mu$ s / div.

### 13.4 PFC Inductor + Switch Voltage and Current, 100% Load

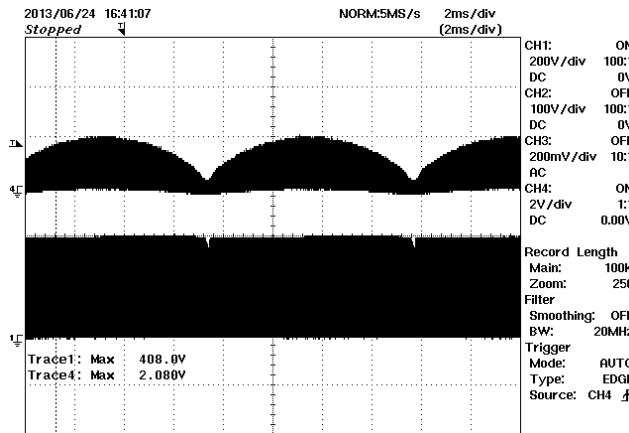
Since the PFC in this power supply utilizes the internal output diode of the HiperPFS-2, the measured drain current cannot be separated from the PFC inductor current.



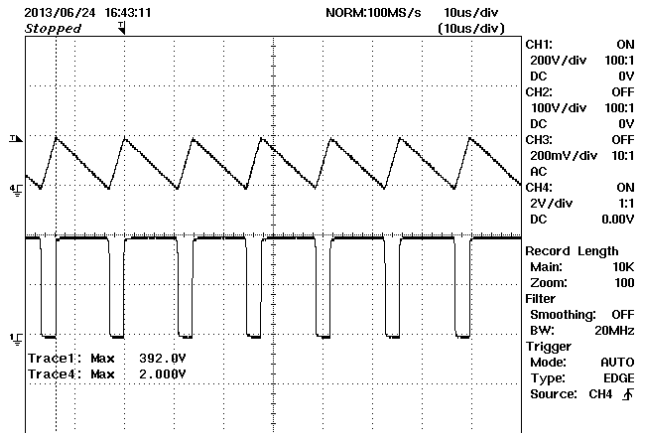
**Figure 36** – PFC Stage Drain Voltage and Current, Full Load, 115 VAC.  
Upper: Switch + Inductor Current, 2 A / div.  
Lower:  $V_{DRAIN}$ , 200 V, 2 ms / div.



**Figure 37** – PFC Stage Drain Voltage and Current, Full Load, 115 VAC.  
Upper: Switch + Inductor Current, 2 A / div.  
Lower:  $V_{DRAIN}$ , 200 V, 20  $\mu$ s / div.

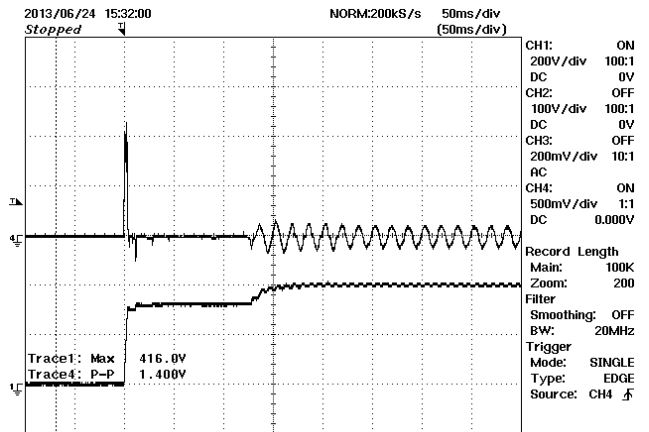
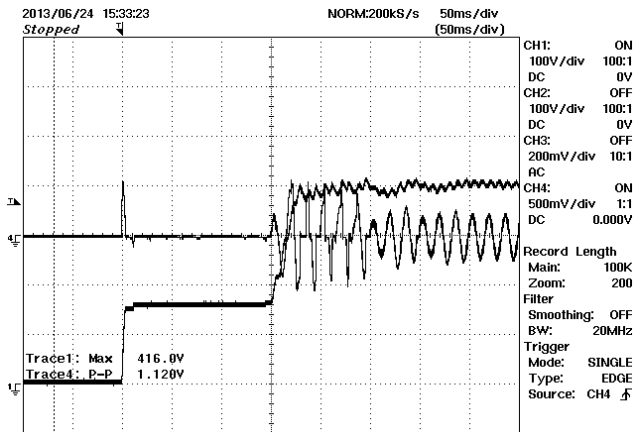


**Figure 38** – PFC Stage Drain Voltage and Current, Full Load, 230 VAC.  
Upper: Switch + Inductor Current, 2 A / div.  
Lower:  $V_{DRAIN}$ , 200 V, 2 ms / div.



**Figure 39** – PFC Stage Drain Voltage and Current, Full Load, 230 VAC.  
Upper: Switch + Inductor Current, 2 A / div.  
Lower:  $V_{DRAIN}$ , 200 V, 10  $\mu$ s / div.

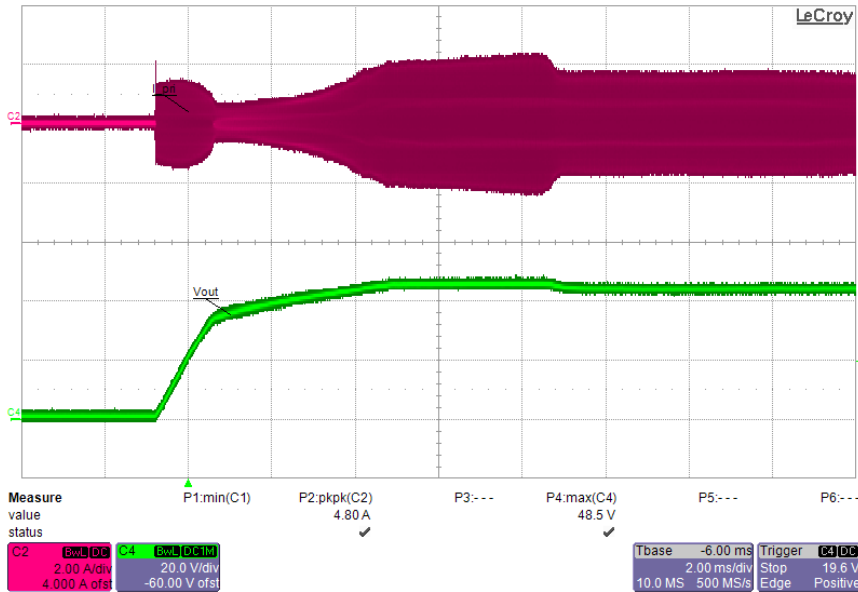
**13.5 AC Input Current and PFC Output Voltage during Start-up**



**Figure 40** – AC Input Current vs. PFC Output Voltage at Start-up, Full Load, 115 VAC.  
 Upper: AC Input Current, 25 A / div.  
 Lower: PFC Voltage, 100 V, 50 ms / div.

**Figure 41** – AC Input Current vs. PFC Output Voltage at Start-up, Full Load, 230 VAC.  
 Upper: AC Input Current, 5 A / div.  
 Lower: PFC Voltage, 200 V, 50 ms / div.

**13.6 LLC Start-up Output Voltage and Transformer Primary Current Using LED Output Load**



**Figure 42** – LLC Start-up. 115 VAC, 100% Load.  
 Upper: LLC Primary Current, 2 A / div.  
 Lower: LLC  $V_{OUT}$ , 20 V, 2 ms / div.

13.7 Output Voltage / Current Start-up Using LED Load

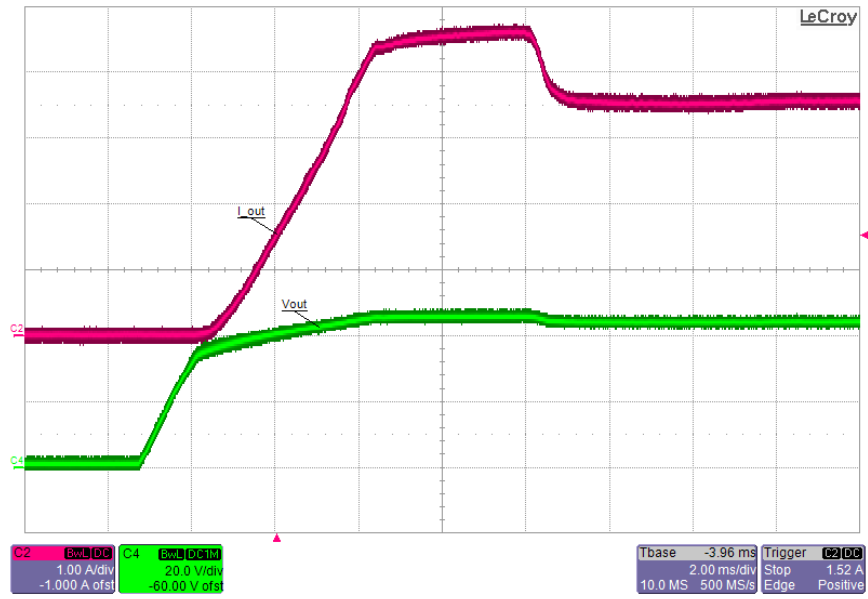
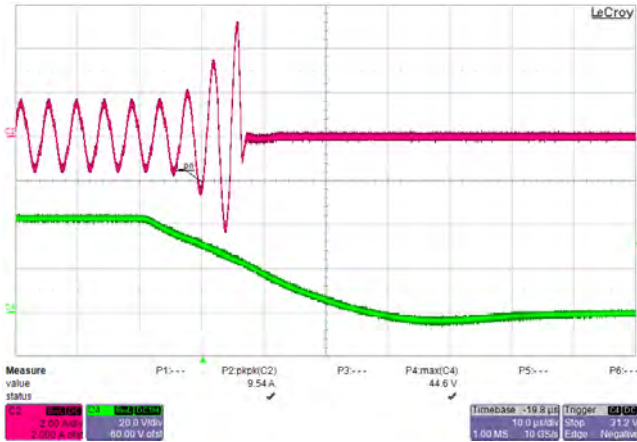


Figure 43 – LLC Start-up. 115 VAC, 100% Load, LED Load.  
 Upper: LLC I<sub>OUT</sub>, 1 A / div.  
 Lower: LLC V<sub>OUT</sub>, 20 V, 2 ms / div.

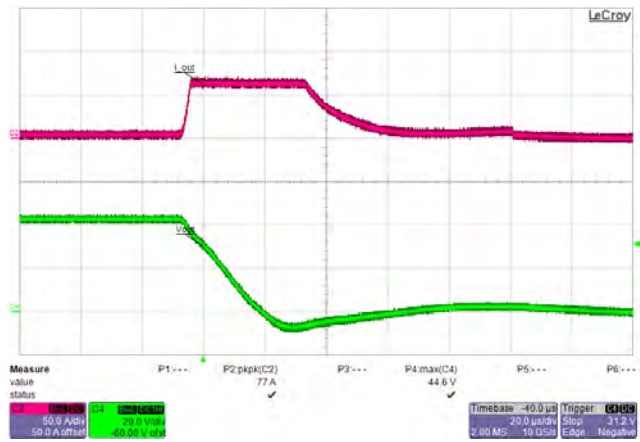


### 13.8 LLC Output Short-Circuit

The figure below shows the effect of an output short circuit on the LLC primary current and on the output current. A mercury displacement relay was used to short the output to get a fast, bounce-free connection.



**Figure 44** – Output Short-Circuit Test.  
 Upper: LLC Primary Current, 2 A / div.  
 Lower: LLC  $V_{OUT}$ , 20 V, 10  $\mu$ s / div.



**Figure 45** – Output Short-Circuit Test.  
 Upper: LLC  $I_{OUT}$ , 50 A / div.  
 Lower: LLC  $V_{OUT}$ , 20 V, 10  $\mu$ s / div.

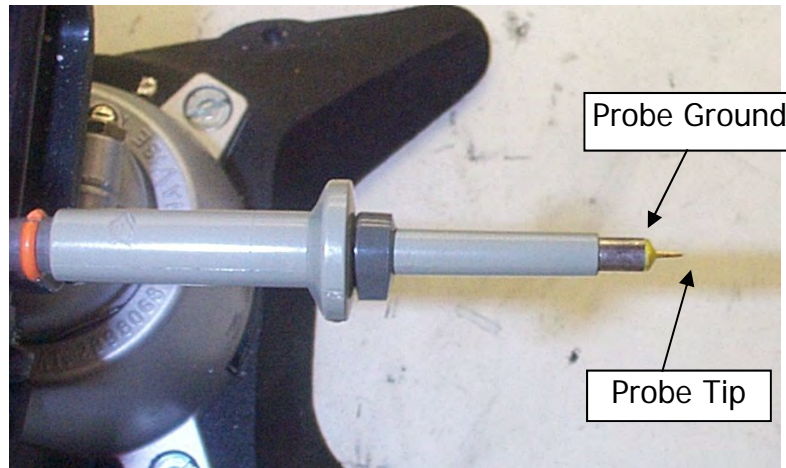


## 13.9 Output Ripple Measurements

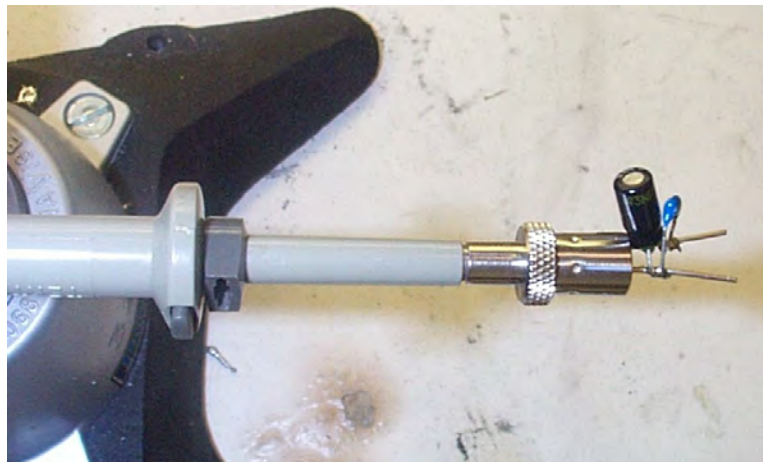
### 13.9.1 Ripple Measurement Technique

For DC output ripple measurements a modified oscilloscope test probe is used to reduce spurious signals. Details of the probe modification are provided in the figures below.

Tie two capacitors in parallel across the probe tip of the 4987BA probe adapter. Use a  $0.1 \mu\text{F}$  / 50 V ceramic capacitor and  $1.0 \mu\text{F}$  / 100 V aluminum electrolytic capacitor. The aluminum-electrolytic capacitor is polarized, so always maintain proper polarity across DC outputs.

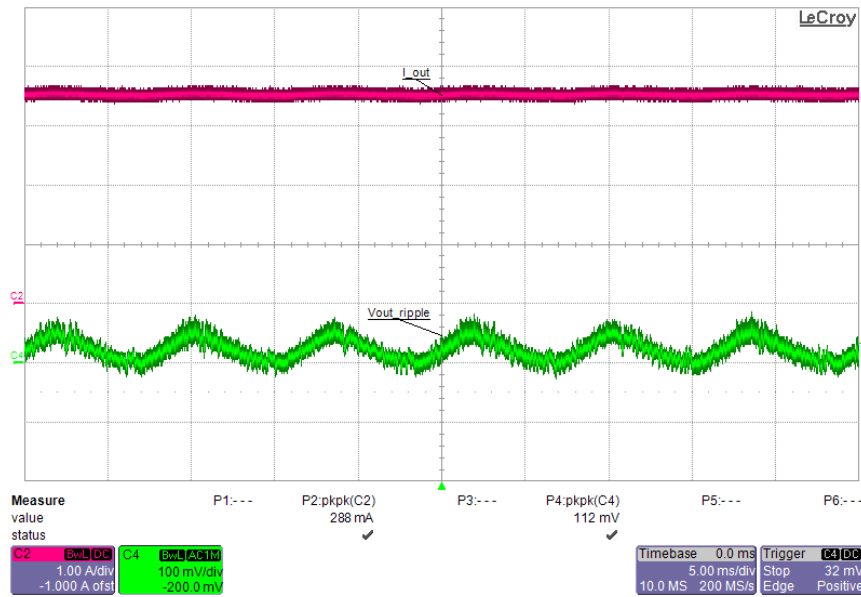


**Figure 46** – Oscilloscope Probe Prepared for Ripple Measurement (End Cap and Ground Lead Removed).



**Figure 47** – Oscilloscope Probe with Probe Master 4987BA BNC Adapter (Modified with Wires for Probe Ground for Ripple measurement and Two Parallel Decoupling Capacitors Added).

### 13.9.2 Ripple Measurements

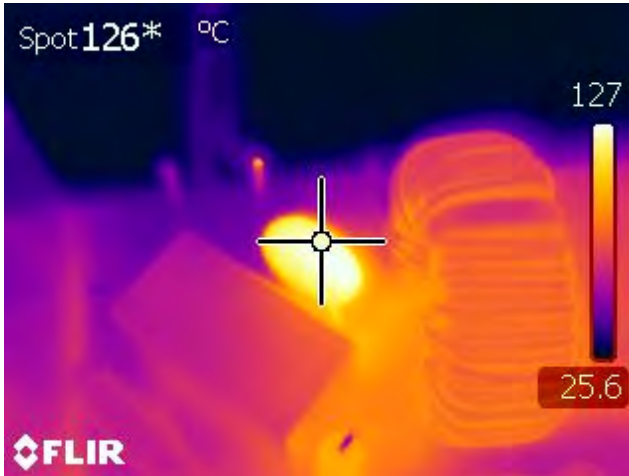


**Figure 48** – Output Ripple, Full Load, 115 VAC.  
Upper: I<sub>OUT</sub>, 1 A / div.  
Lower: Output Voltage Ripple, 100 mV, 5 ms / div.

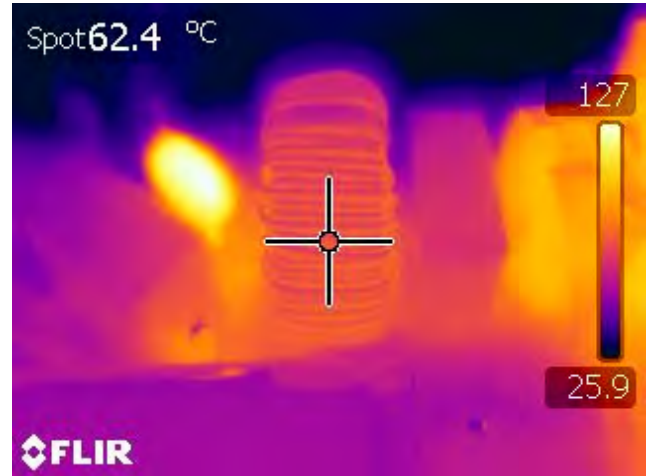
## 14 Temperature Profiles

The board was operated at room temperature, with output set at maximum using a constant resistance load. For each test condition the unit was allowed to thermally stabilize (~1 hr) before measurements were made.

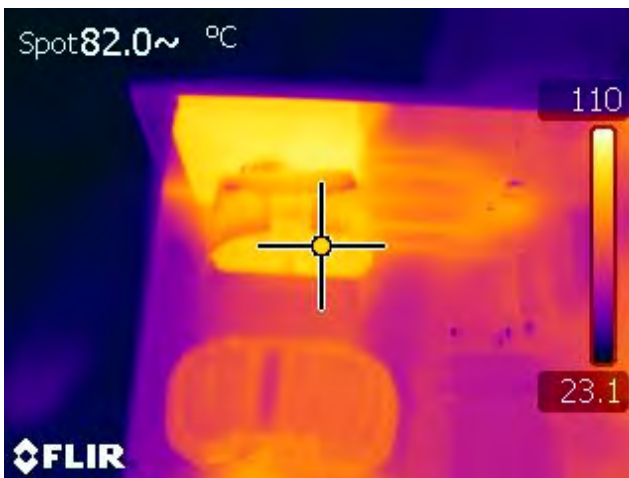
### 14.1 90 VAC, 60 Hz, 150 W Output, Room Temperature



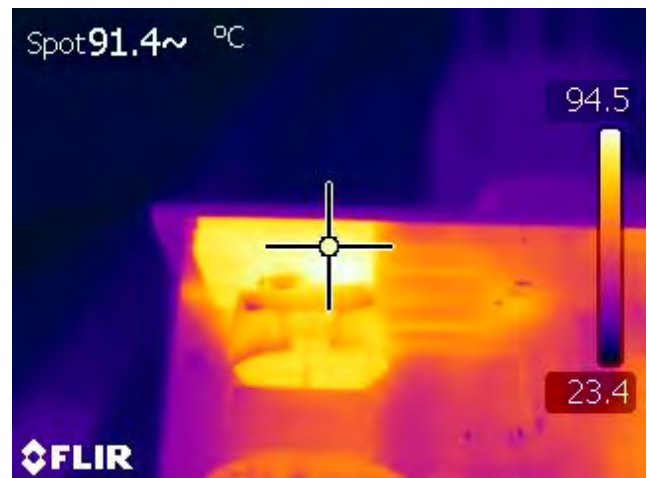
**Figure 49** – Inrush Limiting Thermistor (RT1), 90 VAC Input, 100% Load, Room Temperature.



**Figure 50** – Common Mode Choke (L1), 90 VAC Input, 100% Load, Room Temperature.



**Figure 51** – Differential Mode Choke (L4), 90 VAC Input, 100% Load, Room Temperature.



**Figure 52** – Input Rectifier Bridge (BR1), 90 VAC Input, 100% Load, Room Temperature.

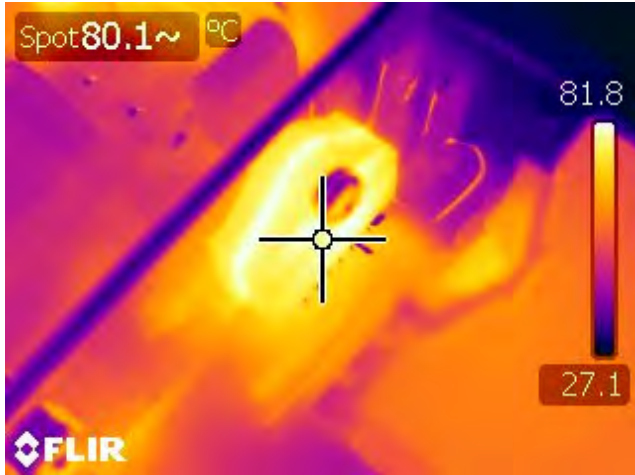


Figure 53 – PFC IC (U1), 90 VAC Input, 100% Load, Room Temperature.

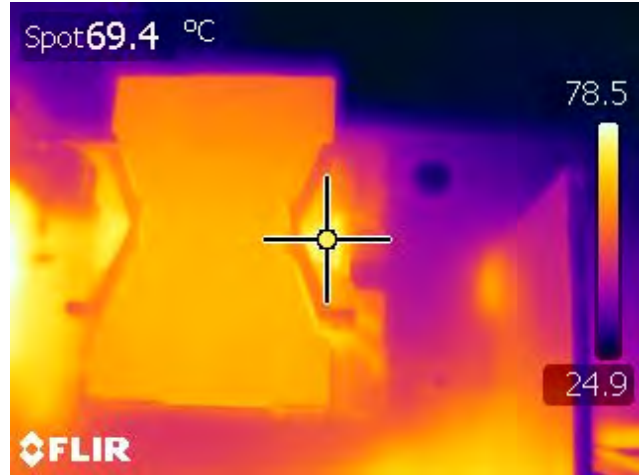


Figure 54 – PFC Inductor (L2), 90 VAC Input, 100% Load, Room Temperature.



Figure 55 – LLC IC (U3), 90 VAC Input, 100% Load, Room Temperature.

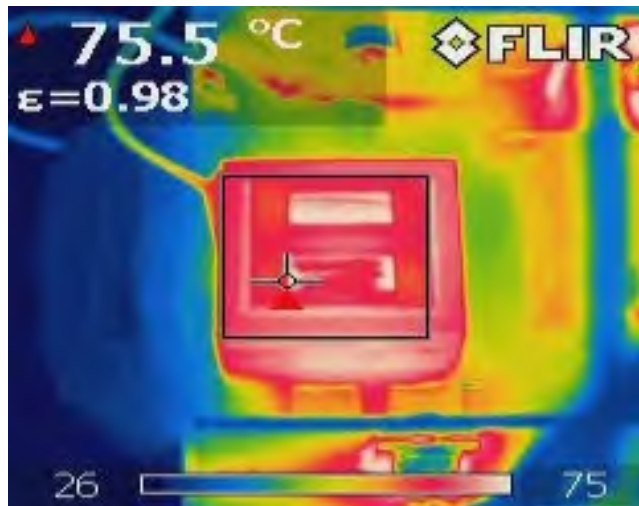
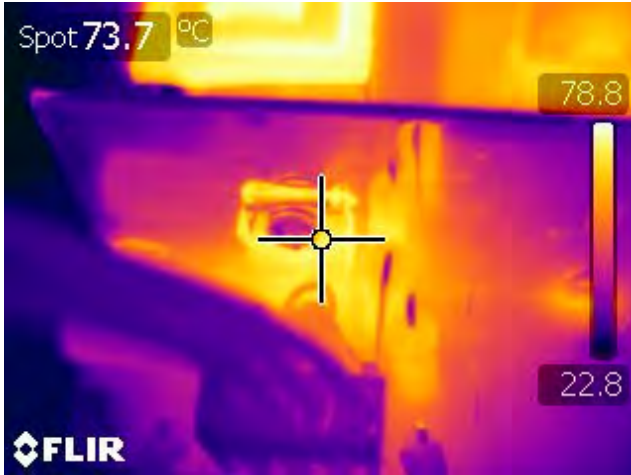


Figure 56 – LLC Transformer (T2), 90 VAC Input, 100% Load, Room Temperature.

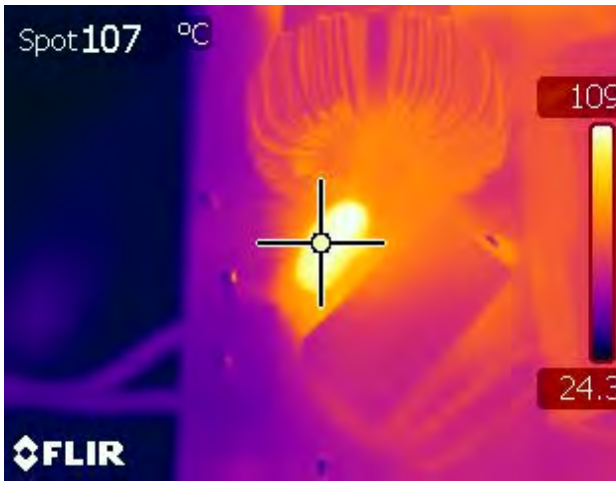


**Figure 57** – Output Rectifier (D11), 90 VAC Input, 100% Load, Room Temperature.

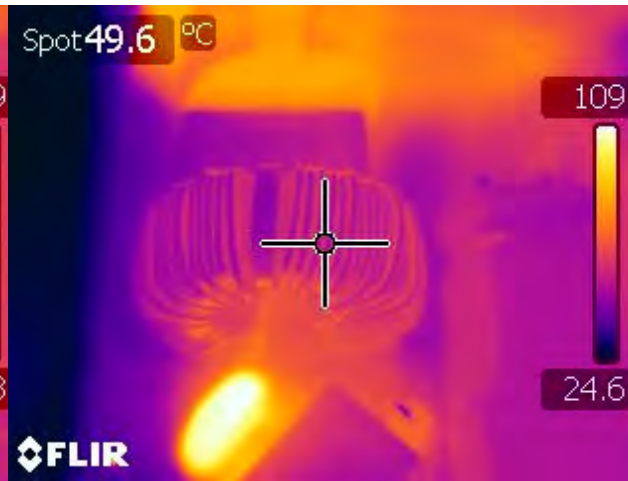


**Figure 58** – Current Sense Resistor (R53), 90 VAC Input, 100% Load, Room Temperature.

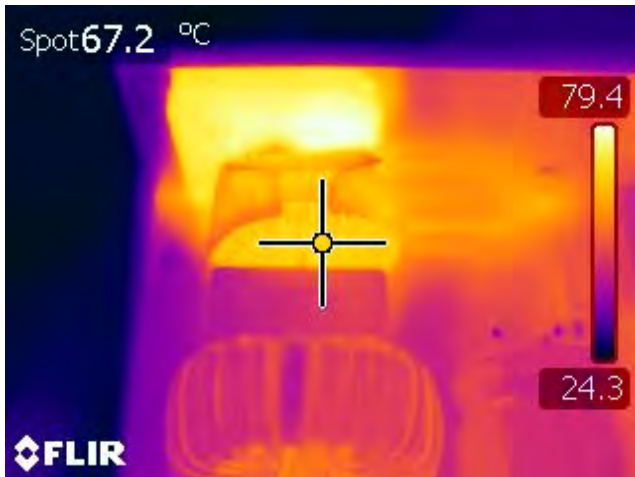
**14.2 115 VAC, 60 Hz, 150 W Output, Room Temperature**



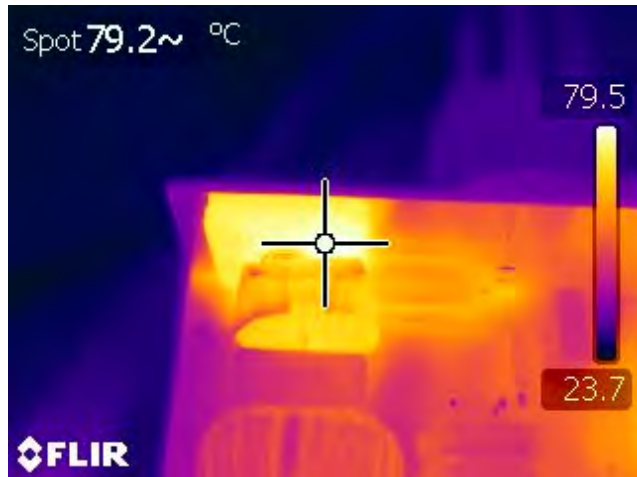
**Figure 59** – Inrush Limiting Thermistor (RT1), 115 VAC Input, 100% Load, Room Temperature.



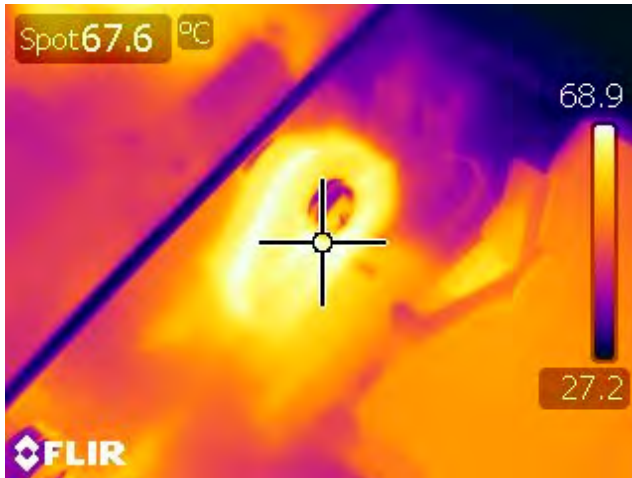
**Figure 60** – Common Mode Choke (L1), 115 VAC Input, 100% Load, Room Temperature.



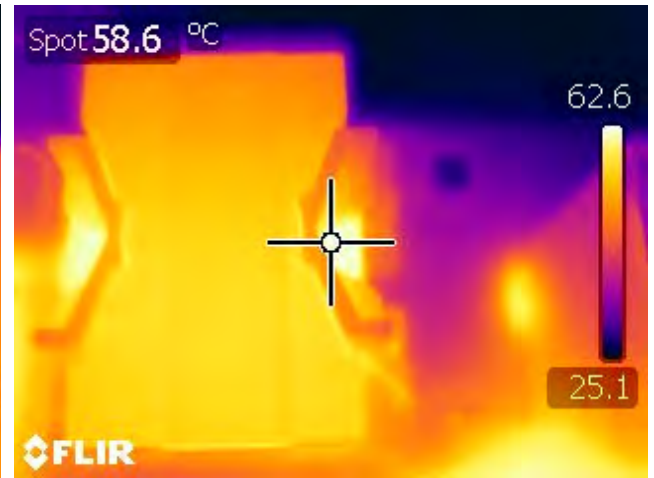
**Figure 61** – Differential Mode Choke (L4), 115 VAC Input, 100% Load, Room Temperature.



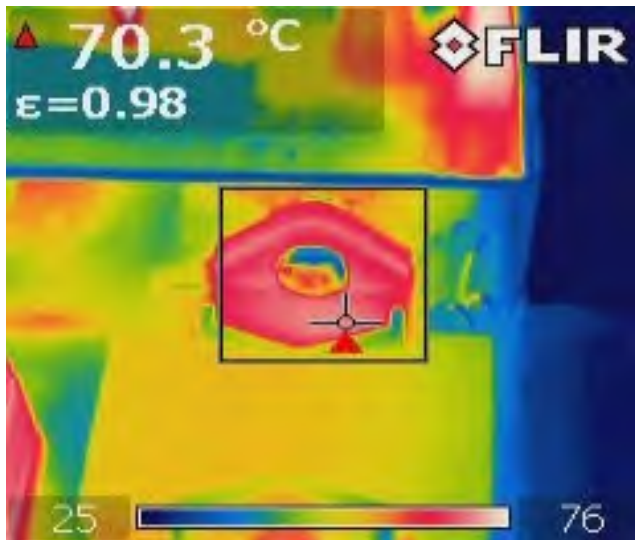
**Figure 62** – Input Rectifier Bridge (BR1), 115 VAC Input, 100% Load, Room Temperature.



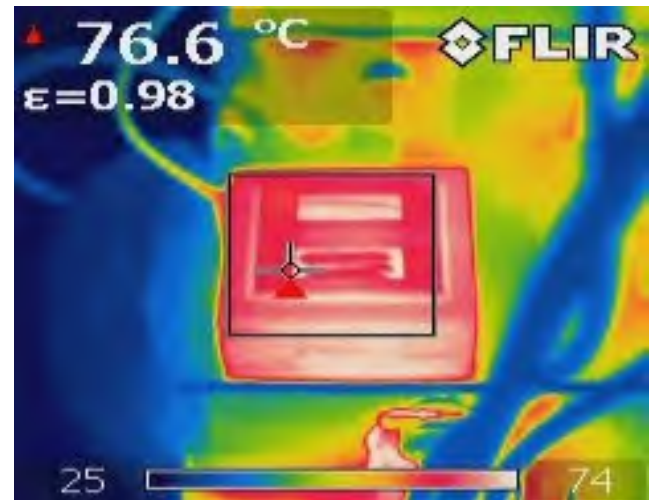
**Figure 63** – PFC IC (U1), 115 VAC Input, 100% Load, Room Temperature.



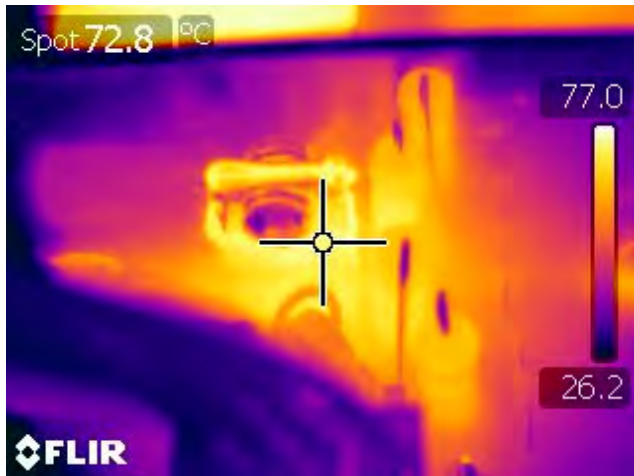
**Figure 64** – PFC Inductor (L2), 115 VAC Input, 100% Load, Room Temperature



**Figure 65** – LLC IC (U3), 115 VAC Input, 100% Load, Room Temperature.



**Figure 66** – LLC Transformer (T1), 115 VAC Input, 100% Load, Room Temperature.



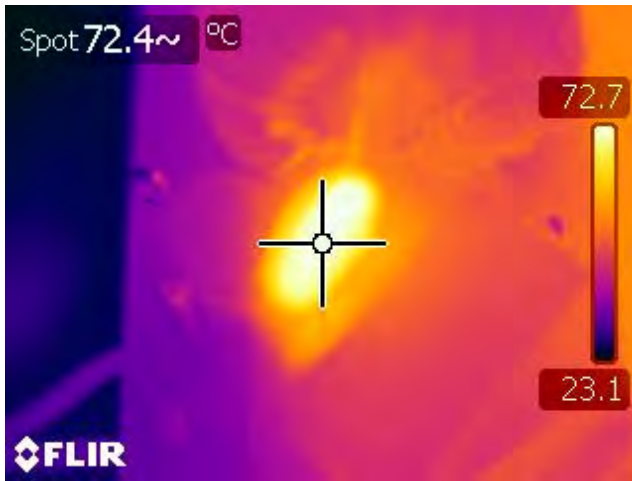
**Figure 67** – Output Rectifier (D11), 115 VAC Input, 100% Load, Room Temperature.



**Figure 68** – Current Sense Resistor (R53), 115 VAC Input, 100% Load, Room Temperature.



**14.3 230 VAC, 50 Hz, 150 W Output, Room Temperature**



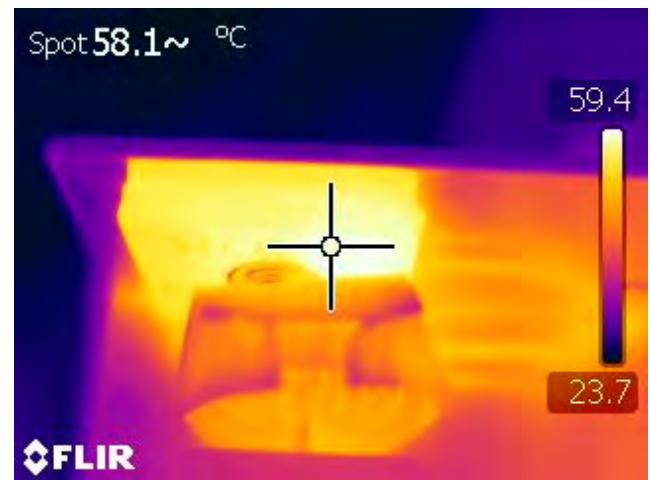
**Figure 69** – Inrush Limiting Thermistor (RT1), 230 VAC Input, 100% Load, Room Temperature.



**Figure 70** – Common Mode Choke (L1), 230 VAC Input, 100% Load, Room Temperature.



**Figure 71** – Differential Mode Choke (L4), 230 VAC Input, 100% Load, Room Temperature.



**Figure 72** – Input Rectifier Bridge (BR1), 230 VAC Input, 100% Load, Room Temperature.

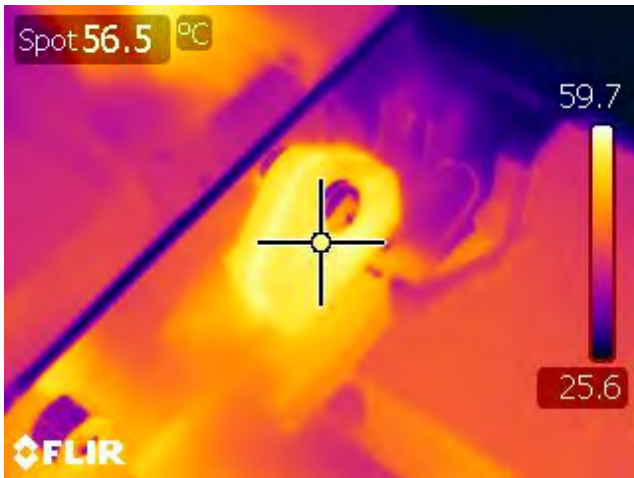


Figure 73 – PFC IC (U1), 230 VAC Input, 100% Load, Room Temperature.

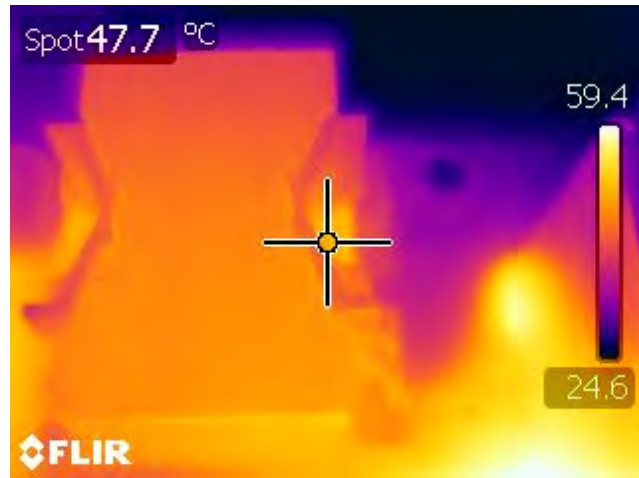


Figure 74 – PFC Inductor (L2), 230 VAC Input, 100% Load, Room Temperature

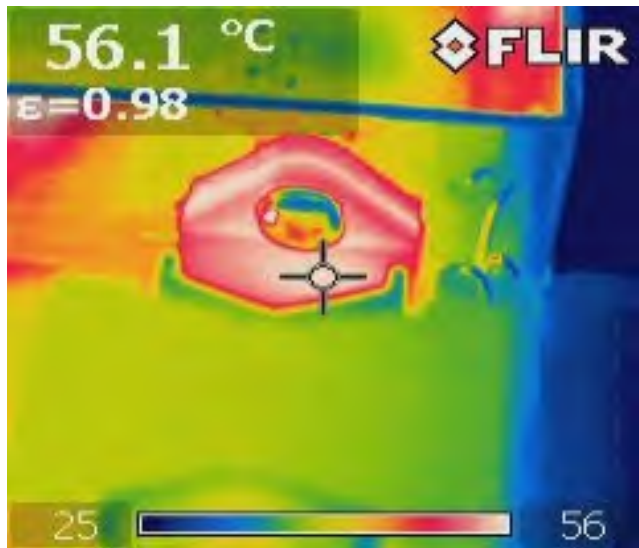


Figure 75 – LLC IC (U3), 230 VAC Input, 100% Load, Room Temperature.

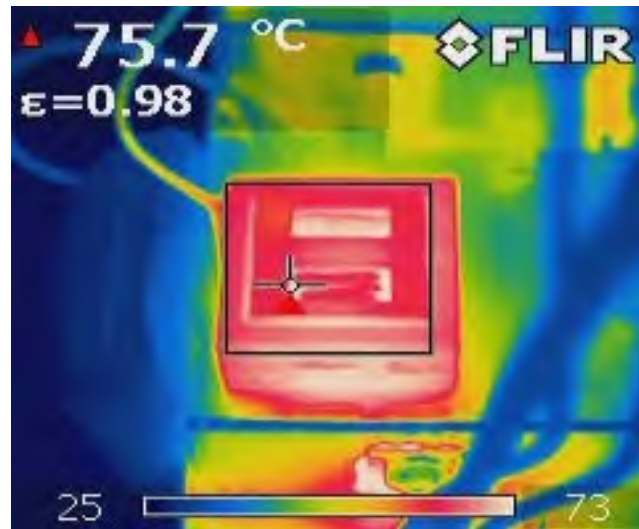


Figure 76 – LLC Transformer (T1), 230 VAC Input, 100% Load, Room Temperature.



**Figure 77** – Output Rectifier (D11), 230 VAC Input, 100% Load, Room Temperature.



**Figure 78** – Current Sense Resistor (R53), 230 VAC Input, 100% Load, Room Temperature.

### 15 Output Gain-Phase

Gain-phase was tested a maximum load using the constant voltage load described in Section 7.1. It is important to use the actual LED load or a load with similar characteristics during gain-phase testing, as a load with different output characteristic will yield inaccurate results.

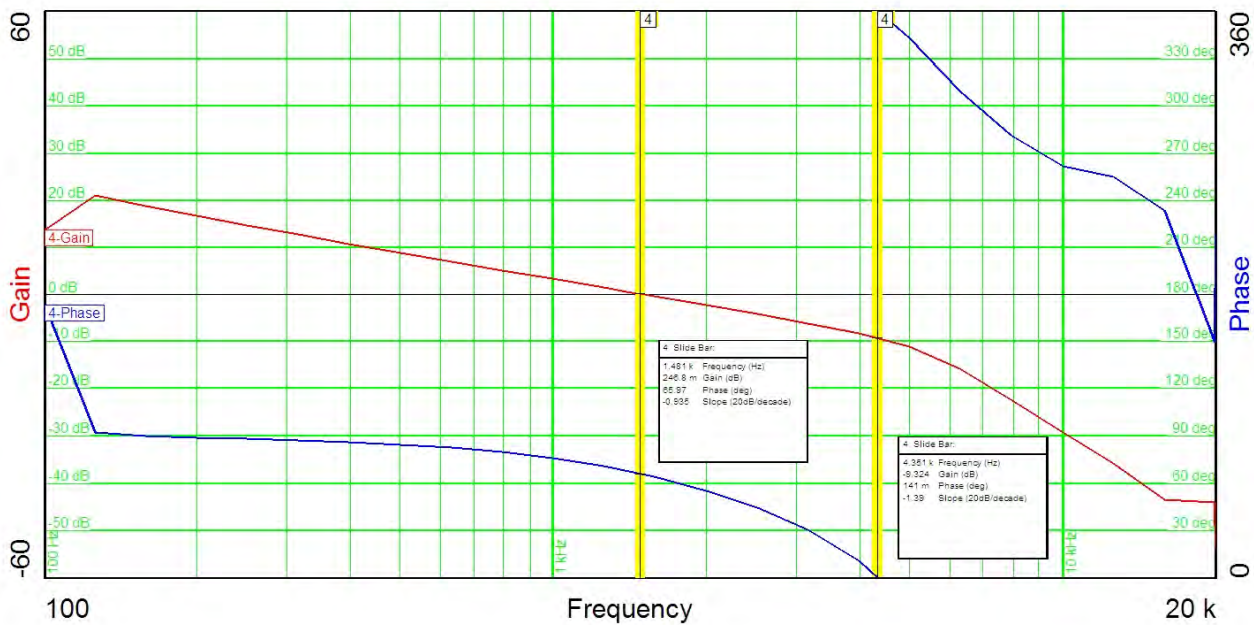


Figure 79 – LLC Converter Gain-Phase, 100% Load Crossover Frequency – 1.5 kHz, Phase Margin - 66°.



## 16 Conducted EMI

Conducted EMI tests were performed using the constant voltage load described in Section 7.1. The output return was connected to the LISN artificial hand to simulate the capacitance of a typical set of LED panels to chassis ground. The step change in readings at 80 MHz is due to an automatic 10 dB scale change of the EMI receiver rather than an actual peak at 80 MHz.

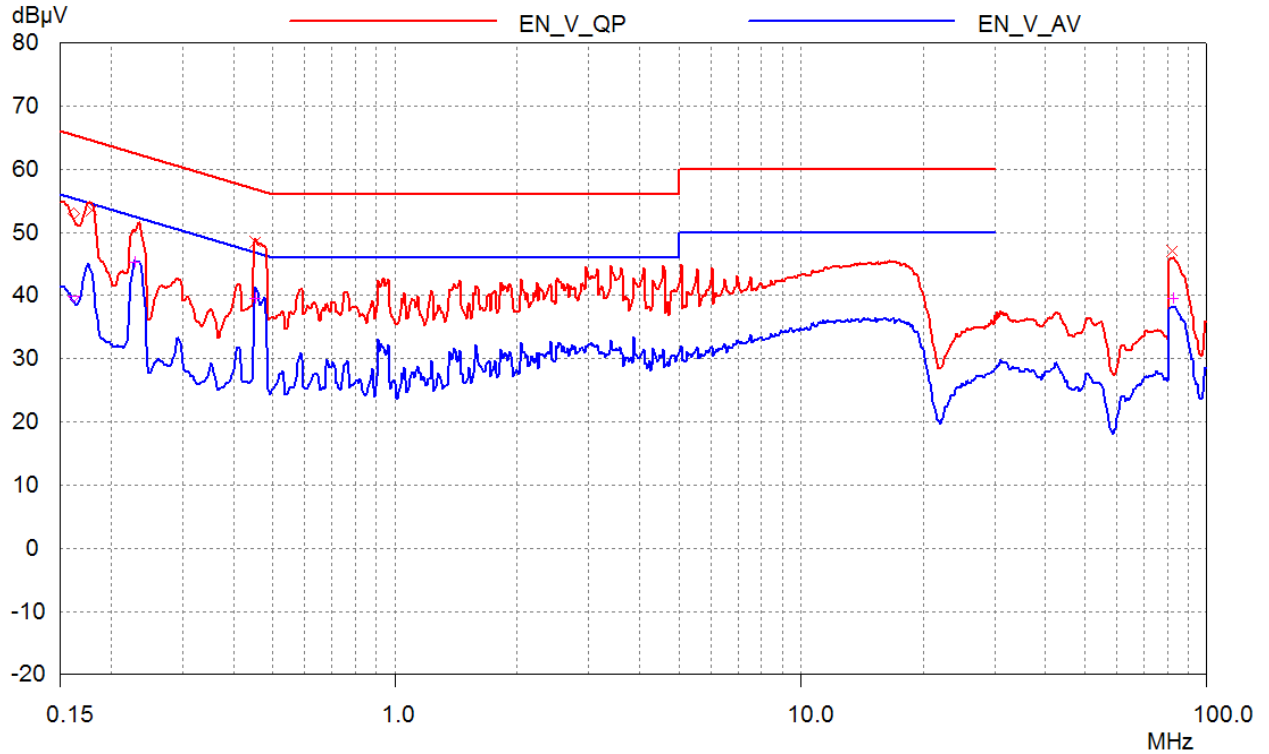


Figure 80 – Conducted EMI, 115 VAC, Full Load.



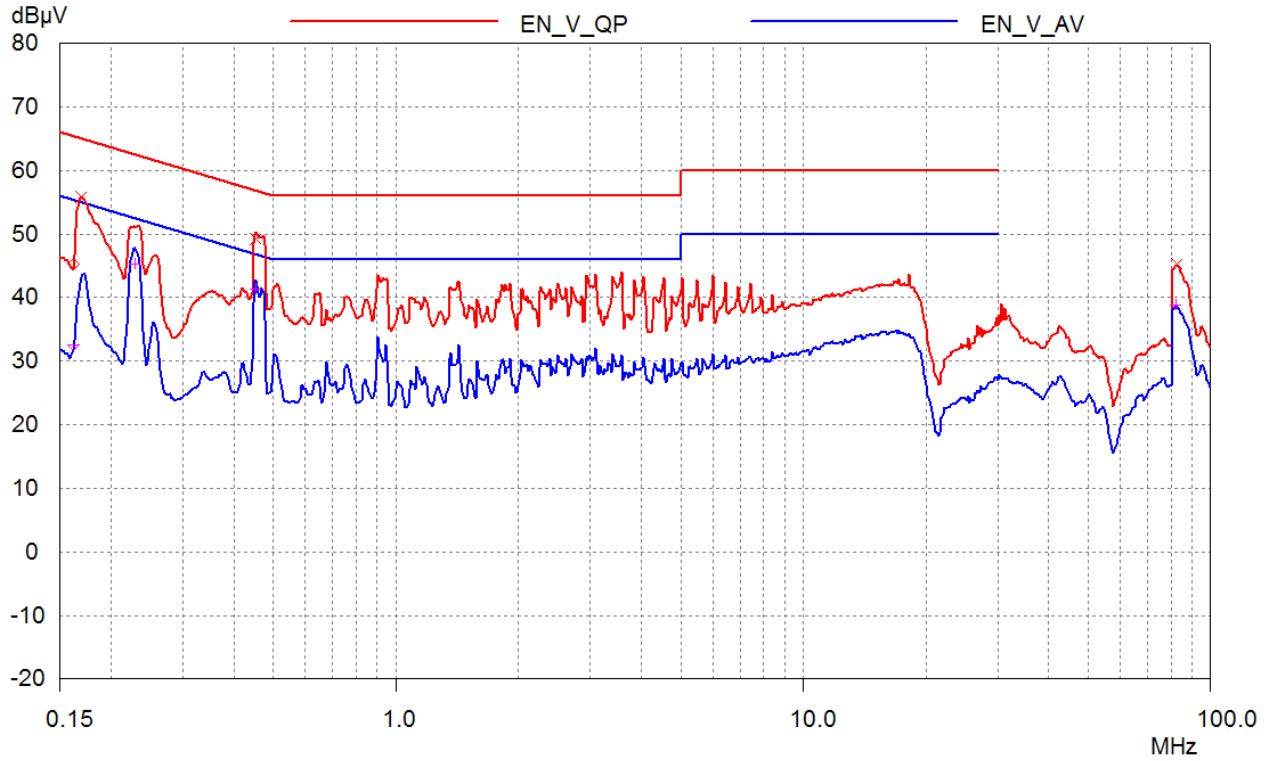


Figure 81 – Conducted EMI, 230 VAC, Full Load.

## 17 Line Surge Testing

### 17.1 Line Surge Test Set-up

The picture below shows the power supply set-up for surge testing. The supply is placed on a ground plane approximately the size of the power supply. A piece of single-sided copper clad printed circuit material was used in this case, but a piece of aluminum sheet with appropriate insulation would also work. An IEC AC connector was wired to the power supply AC input, with the safety ground connected to the ground plane. The CV output load (described in section 7) was placed on top of the ground plane so that it would capacitively couple to the safety ground. A 48 V fan was located inside the plastic shroud shown in the figure, and used to cool the CV load during testing. An indicator consisting of a GaP yellow-green led in series with a 39 V Zener diode and a 100 ohm resistor was placed across the output of the supply and used as a sensitive output dropout detector during line surge testing.

The UUT was tested using a Teseq NSG 3060 surge tester. Results of common mode and differential mode surge testing are shown below. A test failure was defined as a non-recoverable output interruption requiring supply repair or recycling AC input voltage.

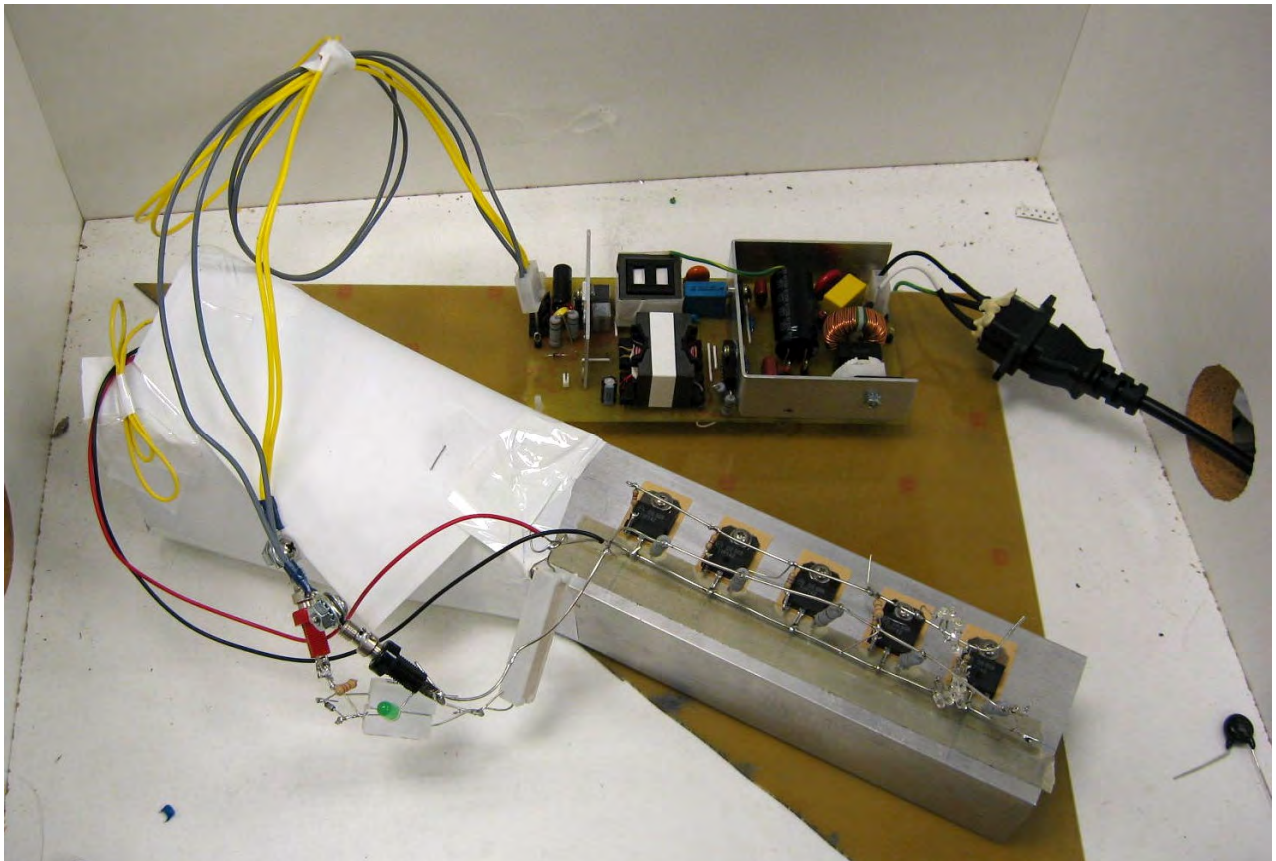


Figure 82 – Line Surge Physical Set-up.

**17.2 Differential Mode Surge, 1.2 / 50  $\mu$ sec**

AC Input Voltage (VAC)	Surge Voltage (kV)	Phase Angle (°)	Generator Impedance ( $\Omega$ )	Number of Strikes	Test Result
115	+2	90	2	10	PASS
115	-2	90	2	10	PASS
115	+2	270	2	10	PASS
115	-2	270	2	10	PASS
115	+2	0	2	10	PASS
115	-2	0	2	10	PASS

AC Input Voltage (VAC)	Surge Voltage (kV)	Phase Angle (°)	Generator Impedance ( $\Omega$ )	Number of Strikes	Test Result
230	+2	90	2	10	PASS
230	-2	90	2	10	PASS
230	+2	270	2	10	PASS
230	-2	270	2	10	PASS
230	+2	0	2	10	PASS
230	-2	0	2	10	PASS

**17.3 Common Mode Surge, 1.2 / 50  $\mu$ sec**

AC Input Voltage (VAC)	Surge Voltage (kV)	Phase Angle (°)	Generator Impedance ( $\Omega$ )	Number of Strikes	Test Result
115	+4	90	12	10	PASS
115	-4	90	12	10	PASS
115	+4	270	12	10	PASS
115	-4	270	12	10	PASS
115	+4	0	12	10	PASS
115	-4	0	12	10	PASS

AC Input Voltage (VAC)	Surge Voltage (kV)	Phase Angle (°)	Generator Impedance ( $\Omega$ )	Number of Strikes	Test Result
230	+4	90	12	10	PASS
230	-4	90	12	10	PASS
230	+4	270	12	10	PASS
230	-4	270	12	10	PASS
230	+4	0	12	10	PASS
230	-4	0	12	10	PASS





**18 Revision History**

Date	Author	Revision	Description and Changes	Reviewed
04-Mar-14	RH	6.1	Initial Release	Apps & Mktg
28-May-14	RH	6.2	Schematic Updated.	
16-Jul-16	KM	6.3	Schematic Updated. Brand Style Updated.	
17-Feb-17	KM	6.4	Updated Heat Sink Drawings	
28-Jun-17	RH	6.5	Corrected Primary heat sink dwg	



## For the latest updates, visit our website: [www.power.com](http://www.power.com)

Power Integrations reserves the right to make changes to its products at any time to improve reliability or manufacturability. Power Integrations does not assume any liability arising from the use of any device or circuit described herein. POWER INTEGRATIONS MAKES NO WARRANTY HEREIN AND SPECIFICALLY DISCLAIMS ALL WARRANTIES INCLUDING, WITHOUT LIMITATION, THE IMPLIED WARRANTIES OF MERCHANTABILITY, FITNESS FOR A PARTICULAR PURPOSE, AND NON-INFRINGEMENT OF THIRD PARTY RIGHTS.

### PATENT INFORMATION

The products and applications illustrated herein (including transformer construction and circuits' external to the products) may be covered by one or more U.S. and foreign patents, or potentially by pending U.S. and foreign patent applications assigned to Power Integrations. A complete list of Power Integrations' patents may be found at [www.power.com](http://www.power.com). Power Integrations grants its customers a license under certain patent rights as set forth at <http://www.power.com/ip.htm>.

The PI Logo, TOPSwitch, TinySwitch, LinkSwitch, LYTSwitch, InnoSwitch, DPA-Switch, PeakSwitch, CAPZero, SENZero, LinkZero, HiperPFS, HiperTFS, HiperLCS, Qspeed, EcoSmart, Clampless, E-Shield, Filterfuse, FluxLink, StackFET, PI Expert and PI FACTS are trademarks of Power Integrations, Inc. Other trademarks are property of their respective companies. ©Copyright 2015 Power Integrations, Inc.

## Power Integrations Worldwide Sales Support Locations

### WORLD HEADQUARTERS

5245 Hellyer Avenue  
San Jose, CA 95138, USA.  
Main: +1-408-414-9200  
Customer Service:  
Phone: +1-408-414-9665  
Fax: +1-408-414-9765  
e-mail: [usasales@power.com](mailto:usasales@power.com)

### GERMANY

Lindwurmstrasse 114  
80337, Munich  
Germany  
Phone: +49-895-527-39110  
Fax: +49-895-527-39200  
e-mail: [eurosales@power.com](mailto:eurosales@power.com)

### JAPAN

Kosei Dai-3 Building  
2-12-11, Shin-Yokohama,  
Kohoku-ku, Yokohama-shi,  
Kanagawa 222-0033  
Japan  
Phone: +81-45-471-1021  
Fax: +81-45-471-3717  
e-mail: [japansales@power.com](mailto:japansales@power.com)

### TAIWAN

5F, No. 318, Nei Hu Rd.,  
Sec. 1  
Nei Hu District  
Taipei 11493, Taiwan R.O.C.  
Phone: +886-2-2659-4570  
Fax: +886-2-2659-4550  
e-mail: [taiwansales@power.com](mailto:taiwansales@power.com)

### CHINA (SHANGHAI)

Rm 2410, Charity Plaza, No. 88,  
North Caoxi Road,  
Shanghai, PRC 200030  
Phone: +86-21-6354-6323  
Fax: +86-21-6354-6325  
e-mail: [chinasales@power.com](mailto:chinasales@power.com)

### INDIA

#1, 14<sup>th</sup> Main Road  
Vasanthanagar  
Bangalore-560052  
India  
Phone: +91-80-4113-8020  
Fax: +91-80-4113-8023  
e-mail: [indiasales@power.com](mailto:indiasales@power.com)

### KOREA

RM 602, 6FL  
Korea City Air Terminal B/D,  
159-6  
Samsung-Dong, Kangnam-Gu,  
Seoul, 135-728 Korea  
Phone: +82-2-2016-6610  
Fax: +82-2-2016-6630  
e-mail: [koreasales@power.com](mailto:koreasales@power.com)

### UK

First Floor, Unit 15, Meadway  
Court, Rutherford Close,  
Stevenage, Herts. SG1 2EF  
United Kingdom  
Phone: +44 (0) 1252-730-141  
Fax: +44 (0) 1252-727-689  
e-mail: [eurosales@power.com](mailto:eurosales@power.com)

### CHINA (SHENZHEN)

17/F, Hivac Building, No. 2, Keji  
Nan 8th Road, Nanshan District,  
Shenzhen, China, 518057  
Phone: +86-755-8672-8689  
Fax: +86-755-8672-8690  
e-mail: [chinasales@power.com](mailto:chinasales@power.com)

### ITALY

Via Milanese 20, 3<sup>rd</sup> Fl.  
20099 Sesto San Giovanni  
(MI) Italy  
Phone: +39-024-550-8701  
Fax: +39-028-928-6009  
e-mail: [eurosales@power.com](mailto:eurosales@power.com)

### SINGAPORE

51 Newton Road,  
#19-01/05 Goldhill Plaza  
Singapore, 308900  
Phone: +65-6358-2160  
Fax: +65-6358-2015  
e-mail: [singaporesales@power.com](mailto:singaporesales@power.com)

### APPLICATIONS HOTLINE

World Wide +1-408-414-9660

### APPLICATIONS FAX

World Wide +1-408-414-9760

