

IEC Appliance Inlet C20 with Filter, Front or Rear Side Mounting



Screw-on mounting  
from front side



Snap-in mounting  
from front side

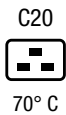

See below:  
[Approvals and Compliances](#)

**Description**

- Panel mount :  
Screw-on version from front or rear side, snap-in version front side
- 2 Functions :  
Appliance Inlet Protection class I , Line filter in standard and medical version
- Solder / quick connect / wires (stranded)

**Unique Selling Proposition**

- Attractive flat front design
- Highly resistant since fully potted
- Interrupts ground loops
- V-Lock cord retaining

**Characteristics**

- Compact design with optimal shielding  
Suitable for assembly in metal plated plastic housings
- Version with class X1 and X2 (standard version) capacitors
- Universal line filter for standard applications
- Suitable for use in medical equipment according to IEC/UL 60601-1 (1 MOOP, 1 MOPP)  
For applications according IEC/UL 62368-1 we recommend variants with bleed resistor

**Other versions on request**

- 16A according to UL
- Capacity CX 330 nF

**References**

Alternative: version without line filter [4793](#); [4798](#)

**Weblinks**

[pdf data sheet](#), [html datasheet](#), [General Product Information](#), [Approvals](#), [Distributor-Stock-Check](#), [Accessories](#), [Detailed request for product](#)

Newly available variants corresponding to V-Lock mating cordset. The connector is equipped with a notch intended for use with the latching cordset. The cord latching system prevents against accidental removal of the cordset.

**Technical Data**

Ratings IEC	16A @ Ta 40 °C / 250VAC; 50Hz	Appliance inlet/-outlet	C20 acc. to IEC 60320-1, UL 498, CSA C22.2 no. 42 (for cold conditions) pin-temperature 70 °C, 16A, Protection Class I
Ratings UL/CSA	20A @ Ta 40 °C / 250VAC; 60Hz	Line Filter	Standard and Medical Version, IEC 60939, UL 1283, CSA C22.2 no. 8 <a href="#">Technical Details</a>
Leakage Current	standard < 0.5 mA (250 V / 60Hz) medical < 5 µA (250 V / 60 Hz)	MTBF	> 3'000'000 h acc. to MIL-HB-217 F
Dielectric Strength	> 1.7 kVDC between L-N > 2.7 kVDC between L/N-PE Test voltage (2 sec)		
Impulse Withstand Voltage	> 2.5 kV between L-N (CX2) > 4 kV between L-N (CX1) > 5 kV between L/N-PE (Cy2) voltage (1.2/50 µs)		
Allowable Operation Temperature	-25 °C to 85 °C		
Climatic Category	25/085/21 acc. to IEC 60068-1		
IP-Protection	front side IP40 acc. to IEC 60529		
Protection Class	Suitable for appliances with protection class I acc. to IEC 61140		
Terminal	Solder / quick connect / wires (stranded)		
Panel Thickness S	Screw: max 8 mm Mounting screw torque max 0.5 Nm Snap-in: 1 mm to 3 mm		
Material	Thermoplastic, black, UL 94V-0		

**Approvals and Compliances**



Detailed information on product approvals, code requirements, usage instructions and detailed test conditions can be looked up in [Details about Approvals](#)

SCHURTER products are designed for use in industrial environments. They have approvals from independent testing bodies according to national and international standards. Products with specific characteristics and requirements such as required in the automotive sector according to IATF 16949, medical technology according to ISO 13485 or in the aerospace industry can be offered exclusively with customer-specific, individual agreements by SCHURTER.

## Approvals







The approval mark is used by the testing authorities to certify compliance with the safety requirements placed on electronic products.

Approval Reference Type: C20F

Approval Logo	Certificates	Certification Body	Description
	<a href="#">VDE Approvals</a>	VDE	VDE Certificate Number: 104884
	<a href="#">UL Approvals</a>	UL	UR File Number: E72928
	<a href="#">CQC Approvals</a>	CQC	CQC Certificate Number: CQC18001191999



## Product standards

Product standards that are referenced

Organization	Design	Standard	Description
	Designed according to	IEC 60320-1	Appliance couplers for household and similar general purposes
	Designed according to	IEC 60939	Passive filters for suppressing electromagnetic interference
	Designed according to	IEC 61058-1	Switches for appliances. Part 1. General requirements
	Designed according to	UL 498	Standard for Attachment Plugs and Receptacles
	Designed according to	UL 1283	Electromagnetic interference filters
	Designed according to	CSA C22.2 no. 42	General Use Receptacles, Attachment Plugs, and Similar Wiring Devices
	Designed according to	CSA C22.2 no. 8	Electromagnetic interference (EMI) filters







## Application standards

Application standards where the product can be used

Organization	Design	Standard	Description
	Designed for applications acc.	IEC/UL 62368-1	Audio/video, information and communication technology equipment - Part 1: Safety requirements
	Designed for applications acc.	IEC 60601-1	Medical electrical equipment - Part 1: General requirements for basic safety and essential performance

### Compliances

The product complies with following Guide Lines

Identification	Details	Initiator	Description
	<a href="#">CE declaration of conformity</a>	SCHURTER AG	The CE marking declares that the product complies with the applicable requirements laid down in the harmonisation of Community legislation on its affixing in accordance with EU Regulation 765/2008.
	<a href="#">UKCA declaration of conformity</a>	SCHURTER AG	The UKCA marking declares that the product complies with the applicable requirements laid down in the British Amendment of Regulation (EC) 765/2008.
	RoHS	SCHURTER AG	Directive RoHS 2011/65/EU, Amendment (EU) 2015/863
	China RoHS	SCHURTER AG	The law SJ / T 11363-2006 (China RoHS) has been in force since 1 March 2007. It is similar to the EU directive RoHS.
	REACH	SCHURTER AG	On 1 June 2007, Regulation (EC) No 1907/2006 on the Registration, Evaluation, Authorization and Restriction of Chemicals 1 (abbreviated as "REACH") entered into force.
		SCHURTER AG	V-Lock system are based on a matching plug-dose combination. The connector is equipped with a notch intended for use with the latching cordset. The cord latching system prevents against accidental removal of the cordset.
	Medical Equipment	SCHURTER AG	Suitable for use in medical equipment according to IEC/UL 60601-1 (1 MOOP, 1 MOPP)

### Dimensions [mm]

Screw-on from front side

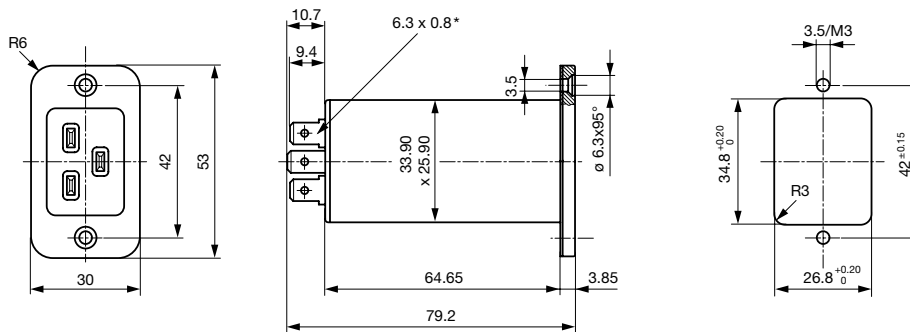

\* Solder terminal: identical outer dimensions

Screw-on mounting from rear side with metal flange

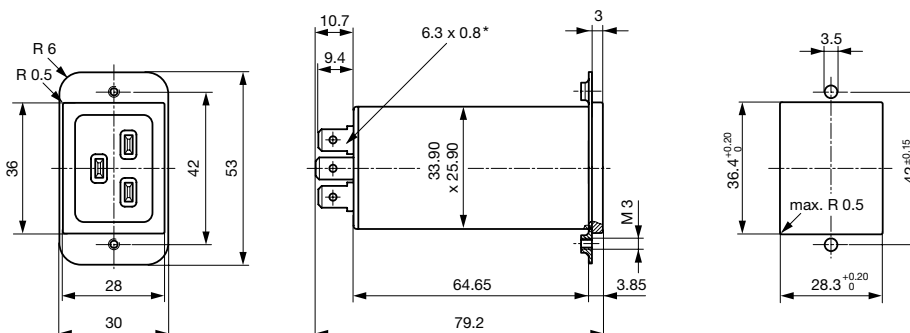

Snap-in mounting from front side

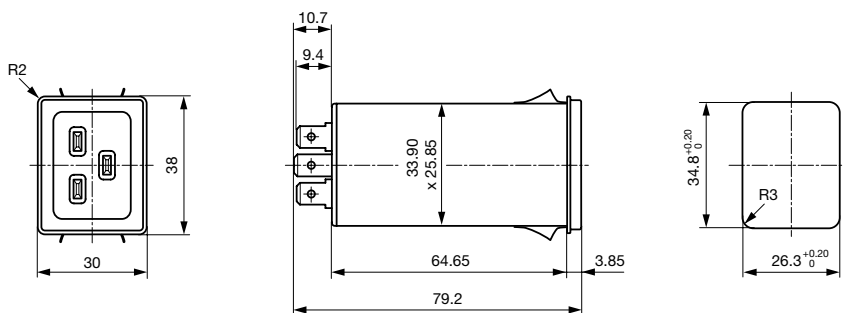

Screw-on mounting from front side with flexible wire

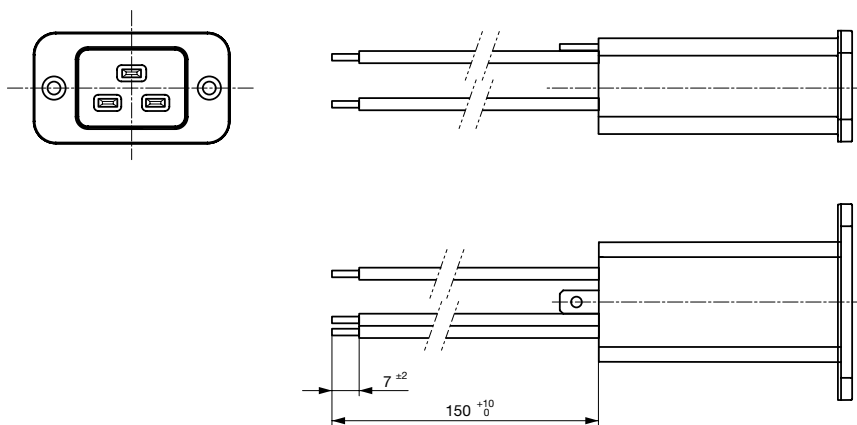

**Technical Data of Filter-Components**

Rated Current [A]	Filter-Type	Inductance L1/ L2 [mH]	Inductance L3 [mH]	Capacitance CX [nF]	Capacitance CY [nF]	R [MΩ]
16	Standard version	2 x 0.3	-	100	2.2	1
16	Standard Version with Ground Line Choke	2 x 0.3	0.15	330	2.2	1
16	Medical Version (M5)	2 x 0.3	-	100	-	1
16	Medical Version (M80)	2 x 0.3	-	100	0.47	1
16	Medical Version (M5) with Ground Line Choke	2 x 0.3	0.15	330	-	1

Diagrams

Standard version

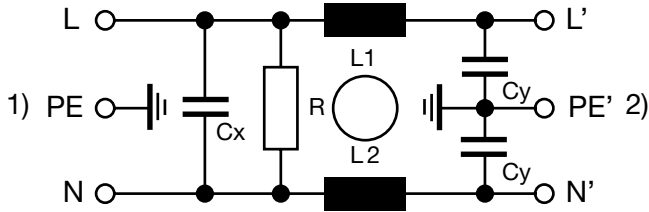

- 1) Line
- 2) Load

Medical Version (M5)

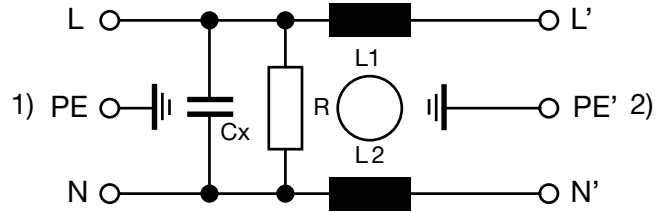

- 1) Line
- 2) Load

Standard version with ground line choke

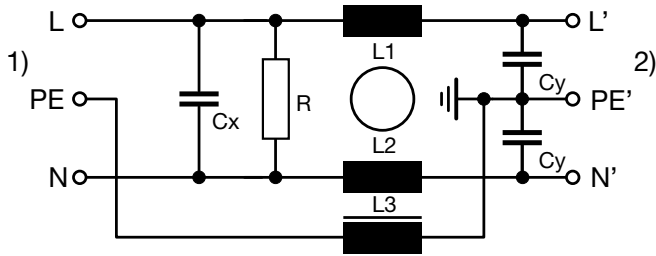

- 1) Line
- 2) Load

Medical Version (M5) with ground line choke

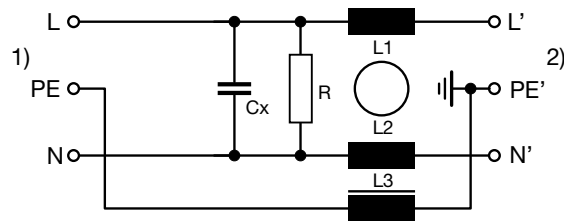

- 1) Line
- 2) Load

Attenuation Loss

--- 50Ω differential mode    \_\_\_\_ 50Ω common mode

Standard version

20 A

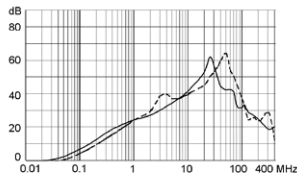

Medical version (M5)

20 A

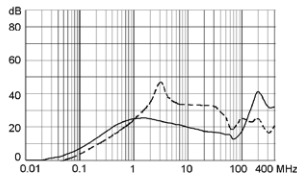

Standard version with ground line choke

20 A

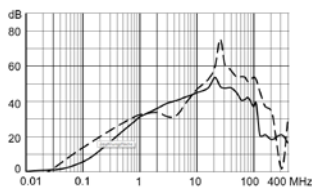

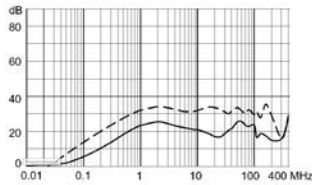
Medical Version (M5) with ground line choke  
20A

## All Variants

Rated Current IEC	Rated Current UL	Filter-Type	Panel mounting	Mounting side	Terminal	Capacitor	V-Lock	Order Number
16	20	Standard version	Snap-in	Front Side	Quick connect terminals 6.3 x 0.8 mm	X2 100nF	●	C20F.0111
16	20	Standard version	Snap-in	Front Side	Quick connect terminals 6.3 x 0.8 mm	X1 100nF	●	C20F.0113
16	20	Standard version	Snap-in	Front Side	Solder terminals	X2 100nF	●	C20F.0011
16	20	Standard version	Snap-in	Front Side	Solder terminals	X1 100nF	●	C20F.0013
16	20	Standard version	Screw	Front Side	Quick connect terminals 6.3 x 0.8 mm	X2 100nF	●	C20F.0101
16	20	Standard version	Screw	Front Side	Quick connect terminals 6.3 x 0.8 mm	X1 100nF	●	C20F.0103
16	20	Standard version	Screw	Front Side	Solder terminals	X2 100nF	●	C20F.0001
16	20	Standard version	Screw	Front Side	Solder terminals	X1 100nF	●	C20F.0003
16	20	Standard version	Screw	Rear Side	Flexible wire AWG14	X2 100nF	●	C20F.0221
16	20	Standard version	Screw	Rear Side	Flexible wire AWG14	X1 100nF	●	C20F.0223
16	20	Standard version	Screw	Rear Side	Quick connect terminals 6.3 x 0.8 mm	X2 100nF	●	C20F.0121
16	20	Standard version	Screw	Rear Side	Quick connect terminals 6.3 x 0.8 mm	X1 100nF	●	C20F.0123
16	20	Standard version	Screw	Rear Side	Solder terminals	X2 100nF	●	C20F.0021
16	20	Standard version	Screw	Rear Side	Solder terminals	X1 100nF	●	C20F.0023
16	20	Standard Version with Ground Line Choke	Snap-in	Front Side	Quick connect terminals 6.3 x 0.8 mm	X2 330nF	●	3-124-295
16	20	Standard Version with Ground Line Choke	Screw	Front Side	Quick connect terminals 6.3 x 0.8 mm	X2 330nF	●	3-124-273
16	20	Medical Version (M5)	Snap-in	Front Side	Quick connect terminals 6.3 x 0.8 mm	X2 100nF	●	C20F.0112
16	20	Medical Version (M5)	Snap-in	Front Side	Quick connect terminals 6.3 x 0.8 mm	X1 100nF	●	C20F.0114
16	20	Medical Version (M5)	Snap-in	Front Side	Solder terminals	X2 100nF	●	C20F.0012
16	20	Medical Version (M5)	Snap-in	Front Side	Solder terminals	X1 100nF	●	C20F.0014
16	20	Medical Version (M5)	Screw	Front Side	Quick connect terminals 6.3 x 0.8 mm	X2 100nF	●	C20F.0102
16	20	Medical Version (M5)	Screw	Front Side	Quick connect terminals 6.3 x 0.8 mm	X1 100nF	●	C20F.0104
16	20	Medical Version (M5)	Screw	Front Side	Solder terminals	X2 100nF	●	C20F.0002
16	20	Medical Version (M5)	Screw	Front Side	Solder terminals	X1 100nF	●	C20F.0004
16	20	Medical Version (M5)	Screw	Rear Side	Flexible wire AWG14	X2 100nF	●	C20F.0022
16	20	Medical Version (M5)	Screw	Rear Side	Flexible wire AWG14	X2 100nF	●	C20F.0222
16	20	Medical Version (M5)	Screw	Rear Side	Flexible wire AWG14	X1 100nF	●	C20F.0024
16	20	Medical Version (M5)	Screw	Rear Side	Flexible wire AWG14	X1 100nF	●	C20F.0224
16	20	Medical Version (M5)	Screw	Rear Side	Quick connect terminals 6.3 x 0.8 mm	X2 100nF	●	C20F.0122
16	20	Medical Version (M5)	Screw	Rear Side	Quick connect terminals 6.3 x 0.8 mm	X1 100nF	●	C20F.0124
16	20	Medical Version (M5) with Ground Line Choke	Screw	Front Side	Quick connect terminals 6.3 x 0.8 mm	X2 330nF	●	3-124-294

Rated Current IEC	Rated Current UL	Filter-Type	Panel mounting	Mounting side	Terminal	Capacitor	V-Lock	Order Number
<p>Most Popular.</p> <p>Availability for all products can be searched real-time: <a href="https://www.schurter.com/en/Stock-Check/Stock-Check-SCHURTER">https://www.schurter.com/en/Stock-Check/Stock-Check-SCHURTER</a></p> <p>Wire length: 150 mm</p> <p>The fuse drawer is not included and must be ordered separately (see required accessory).</p>								
<b>Packaging unit</b>			20 Pcs					

**Accessories**

**Description**



**Wire Harness**  
 Wire harness for SCHURTER products



**Assorted Covers**  
 Rear Cover

0859.0047



**RC320**  
 Rear Cover for Power Entry Module



**Cord retaining kits**  
 Cord retaining strain relief

Countersunk, K

4700.0010

Flat head, L

4700.0011

Mating Outlets/Connectors

Category / Description



[Connector Overview complete](#)

4795, Mounting: Power Cord, Cable Connector: IEC C19	4795
4790, Mounting: Power Cord, Screw Connector: IEC C19	4790
0104U, Mounting: Power Supply Cord, Screw clamps Connector: IEC C19	0104U

Mating Outlets/Connectors shuttered



[Power Cord Overview complete](#)

VAC19KS, Overview, V-Lock cord retaining, diverse Connector IEC C19, diverse, black	VAC19KS
---	---------