

# Dual Channel SiC MOSFET Driver

Gate Driver for 1200V, 62mm SiC MOSFET Power Module

## Features

- 2 output channels
- Integrated isolated power supply
- Direct mount low inductance design
- Short circuit protection
- Under voltage protection

## For use with Cree Modules

- CAS300M12BM2, 1200V, 300A module.
- CAS120M12BM2, 1200V, 120A module.

## Applications

- Driver for SiC MOSFET modules in industrial applications.
- DC Bus voltage up to 1000V

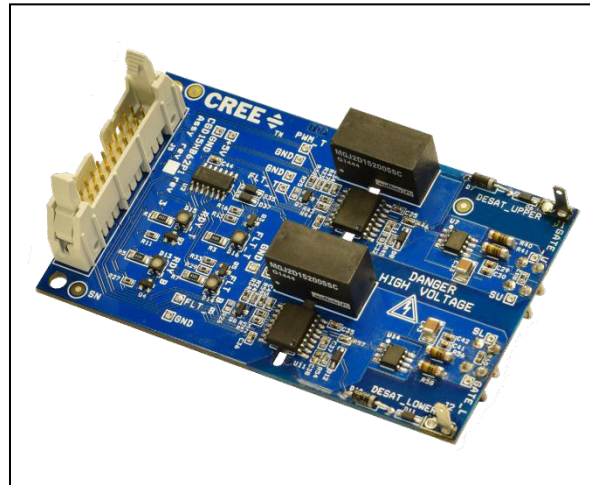

Part Number	Package	Marking
CGD15HB62P1	PCBA	CGD15HB62P1

## Absolute Maximum Ratings

Symbol	Parameter	Value	Unit	Test Conditions	Note
$V_s$	Power Supply Voltage	16	V		
$V_{iH}$	Input signal voltage HIGH	5	V		
$V_{iL}$	Input signal voltage LOW	0	V		
$I_{O,pk}$	Output peak current	$\pm 9 (\pm 2)$	A	Gate drive capable of 9A, but 10 $\Omega$ of gate resistance lowers peak to 2A	
$P_{O,AVG}$	Output power per gate	1.8	W		
$F_{Max}$	Max. Switching frequency	64	kHz		
$V_{DS}$	Max. Drain to source voltage	1200	V		
$V_{isol}$	Input to output isolation voltage	$\pm 1200$	V		
dv/dt	Rate of change of output to input voltage	50,000	V/ $\mu$ s		

W	Weight	44	g	
MTBF	Mean time between failure	1.5x10 <sup>6</sup>	h	
T <sub>op</sub>	Operating temperature	-35 to 85	°C	
T <sub>stg</sub>	Storage temperature	-40 to 85	°C	

### Characteristics

Symbol	Parameter	Value			Unit	Test Conditions	Notes
		Min	Typ	Max			
V <sub>S</sub>	Supply voltage	14	15.0	16	V		
V <sub>i</sub>	Input signal voltage on/off		5/0		V		
I <sub>SO</sub>	Supply current (no load)		72		mA	25C	
	Supply current (max.)		300	360		f=64khz, 25C	
V <sub>IT+</sub>	Input threshold voltage HIGH	3.5			V		
V <sub>IT-</sub>	Input threshold voltage LOW			1.5	V		
R <sub>in</sub>	Input resistance		48		kΩ		
C <sub>io</sub>	Coupling capacitance		10		pf		
t <sub>don</sub>	Turn on propagation delay		300		nS	Time from when input pin goes high until driver output goes high	Fig.3, 4
t <sub>doff</sub>	Turn off propagation delay		300		nS	Time from when input pin goes low until driver output goes low	Fig.3, 4
t <sub>Rout</sub>	Output voltage rise time		65		nS	V <sub>OUT</sub> time from 10% to 90% with R <sub>G</sub> = 0ohms, C <sub>LOAD</sub> = 40,000pf	Fig. 5
t <sub>Fout</sub>	Output voltage fall time		50		nS	V <sub>OUT</sub> time from 90% to 10% with R <sub>G</sub> = 0ohms, C <sub>LOAD</sub> = 40,000pf	Fig. 5
R <sub>GON</sub>	Turn-on gate resistor		10		Ω		
R <sub>GOFF</sub>	Turn-off gate resistor		10		Ω		
V <sub>GATEON</sub>	Gate voltage at turn-on		+20		V		
V <sub>GATEOFF</sub>	Gate voltage at turn-off		-5		V		
t <sub>SC</sub>	Short Circuit Response Time		1.5		μS	Total time from when short circuit current begins flowing until it is interrupted	
V <sub>DS,TRIP</sub>	V <sub>DS</sub> monitoring threshold		4.7		V	V <sub>DS</sub> value that causes the driver to trip on overcurrent	
t <sub>FLT,DLY</sub>	Fault Delay Time		425		nS	Time from when desat pin=9V until the gate output begins turning off	

$t_{FLT\_SIG}$	Transmission delay of fault state			2.25	$\mu S$	Time delay from desat pin=9V until fault status pin is pulled low
$t_{err}$	Pulse width for resetting fault	800			nS	Time reset pin must be held low to reset driver
	Test voltage (60Hz/1 min), Primary to secondary		4000		V	
	Test voltage (60Hz/1 min), Secondary to secondary		4000		V	
	Creepage distance, Primary to secondary		7.6		mm	
	Creepage distance, Secondary to secondary		6.7		mm	
	Clearance distance, Primary to secondary		4.0		mm	
	Clearance distance, Secondary to secondary		6.7		mm	

### Block Diagram

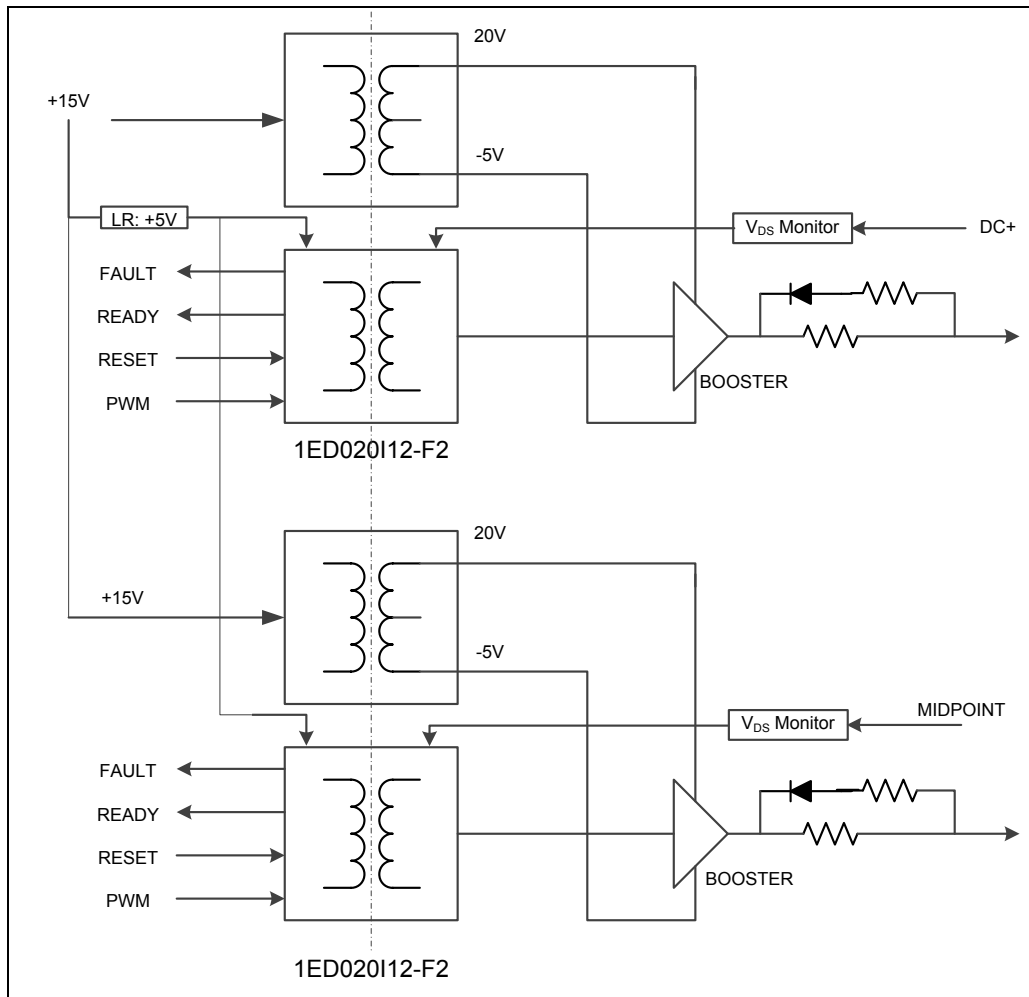
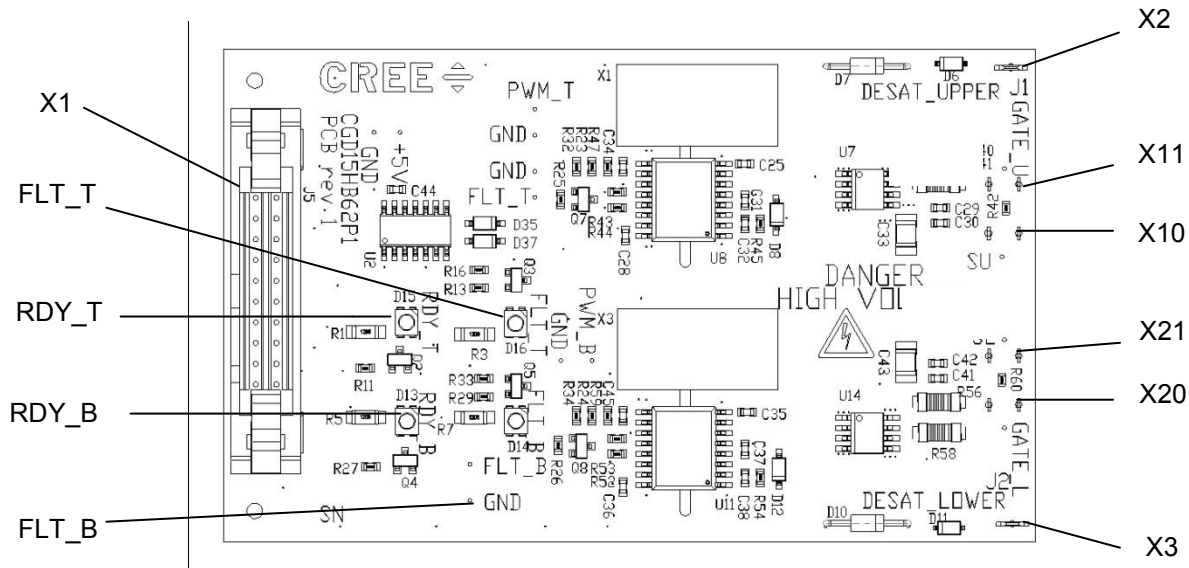

Figure 1. Block Diagram

### Driver Interface



**Figure 2. Top View**

**X1 – 20 pos connector (FCI p/n# 71918-120LF)**

1	COMMON	2	GATE UPPER
3	COMMON	4	RESET UPPER
5	COMMON	6	READY UPPER
7	COMMON	8	FAULT UPPER
9	COMMON	10	GATE LOWER
11	COMMON	12	RESET LOWER
13	COMMON	14	READY LOWER
15	COMMON	16	FAULT LOWER
17	COMMON	18	VCC IN
19	COMMON	20	VCC IN
<b>X2</b>	Desat top switch connector	<b>X3</b>	Desat lower switch connector
<b>LED Status Indicators</b>			
<b>FLT_T</b>	Red LED illuminated indicates there is a fault on the top channel	<b>FLT_B</b>	Red LED illuminated indicates there is a fault on the bottom channel
<b>RDY_T</b>	Green LED illuminated indicates top channel is powered and ready	<b>RDY_B</b>	Green LED illuminated indicates top channel is powered and ready

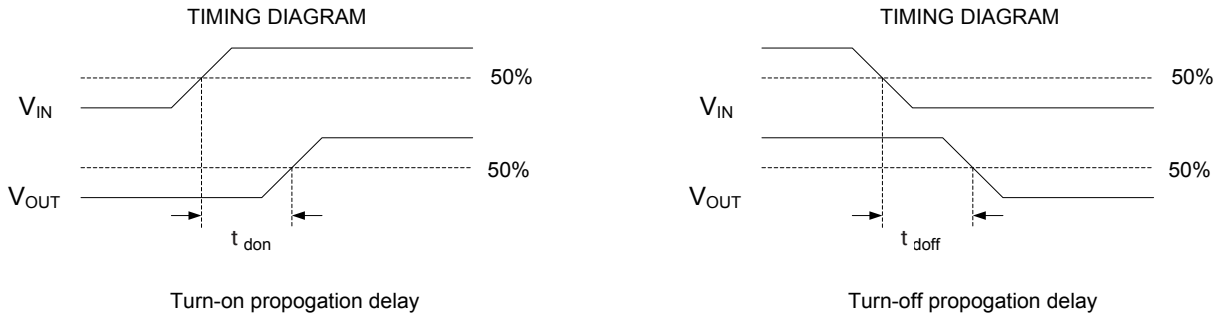

**Figure 3. Propagation Delays**

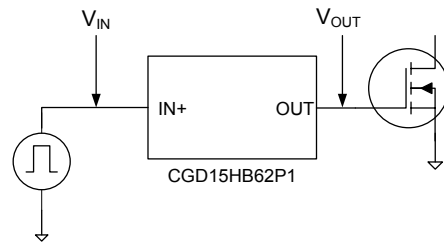

**Figure 4. Propagation Delay Test Circuit**

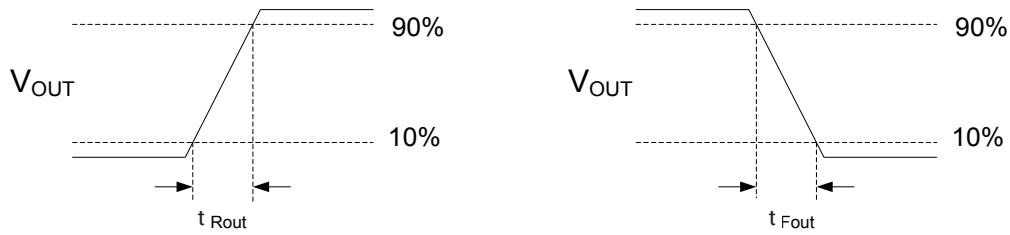

**Figure 5. Output Voltage Rise and Fall Times**

## Mounting Instructions

Designed to directly mount to Cree 62mm style power modules. Four (4) mounting holes for 4x M4-8, Nylon screws are provided to secure the board to a bracket or enclosure (0.5 Nm) for additional support.

External wires with spade style connectors (part numbers listed below) should be used to connect the Desat detect pins (X2 & X3) from the module to the gate drive board.

### Connectors (female) that fit Desat blade terminal

Right angle connector: TE Connectivity 61070-1  
 Straight connector: Molex 19002-0013



Figure 6. CGD15HB62P1 Mounted with Desat Connections

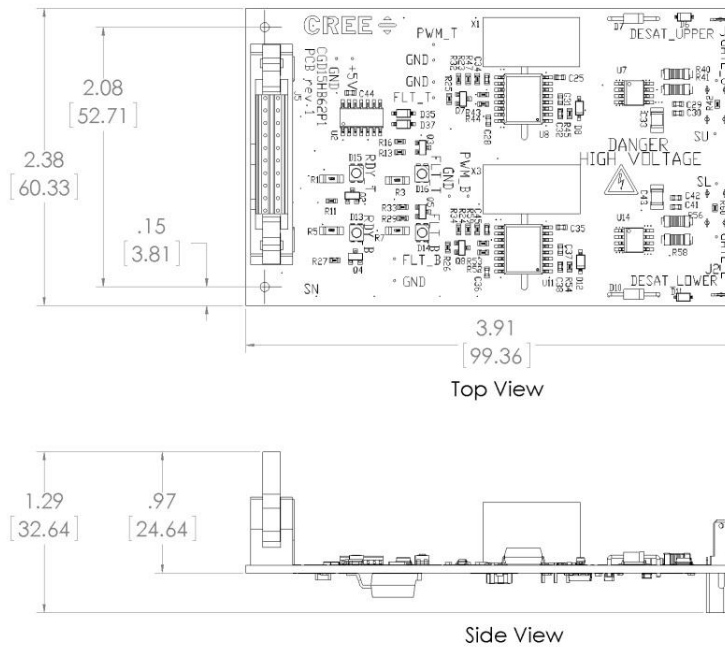

Mechanical Units: inches [mm]

This product has not been designed or tested for use in, and is not intended for use in, applications implanted into the human body nor in applications in which failure of the product could lead to death, personal injury or property damage, including but not limited to equipment used in the operation of nuclear facilities, life-support machines, cardiac defibrillators or similar emergency medical equipment, aircraft navigation or communication or control systems or air traffic control systems.

Copyright © 2015 Cree, Inc. All rights reserved. The information in this document is subject to change without notice. Cree and the Cree logo are registered trademarks and Z-REC and Z-FET are trademarks of Cree, Inc.

Cree, Inc.  
 4600 Silicon Drive  
 Durham, NC 27703  
 USA Tel: +1.919.313.5300  
 Fax: +1.919.313.5451  
[www.cree.com/power](http://www.cree.com/power)