

Common features

- Instant ejection of relay by plastic retaining clip
- Integral coil indication and protection circuit
- 35 mm rail (EN 60715) mounting

6.2 mm wide

- EMR - DC, AC or AC/DC coil versions
- SSR - DC or AC/DC input versions
- Screw and Screwless terminal options

EMR
Electromechanical Relays

38.51/38.61

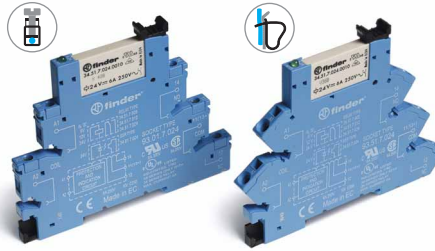

• 1 CO - 6 A 250VAC

Page 1

SSR
Solid State Relays

38.81/38.91

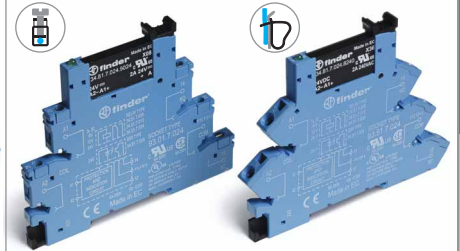

- Single solid state output:
Options 0.1A 48VDC, 2A 24VDC, 2A 240VAC
- Silent, high speed switching
- Long electrical life

Page 2

6.2 mm wide

- Special coil / input leakage current suppression types
- EMR - AC or AC/DC coil versions
- SSR - AC or AC/DC input versions
- Screw and Screwless terminal options

38.51.3... - 38.61.3...

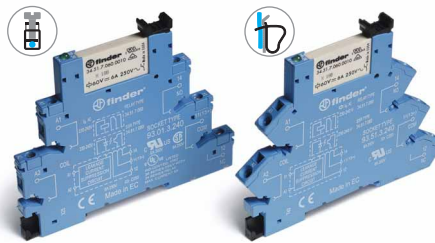

• 1 CO - 6 A 250VAC

Page 1

38.81.3... - 38.91.3...

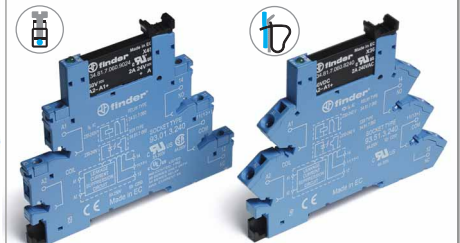

- Single solid state output:
Options 0.1A 48VDC, 2A 24VDC, 2A 240VAC
- Silent, high speed switching
- Long electrical life

Page 2

6.2 mm wide

- Timed Interface module
- 4 functions & 4 time scales 0.1s ... 6h
- EMR - AC/DC (12 or 24V) supply versions
- SSR - AC/DC (24V) supply
- Screw terminals

38.21



• 1 CO - 6 A 250VAC

Page 3

38.21...9024-8240

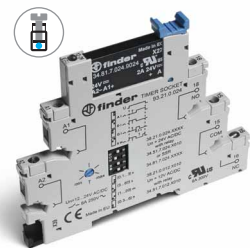

- Single solid state output:
Options 2A 24VDC, 2A 240VAC
- Silent, high speed switching
- Long electrical life

Page 3

14 mm wide

- 2 pole 8 A or 1 pole 16 A
- EMR - DC or AC/DC coil versions
- SSR - DC input versions
- Screw and Screwless terminal options

38.01/38.52/38.11/38.62

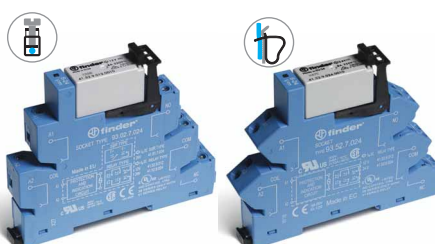

• 1 CO - 16 A 250VAC
• 2 CO - 8 A 250VAC

Page 4

38.31/38.41

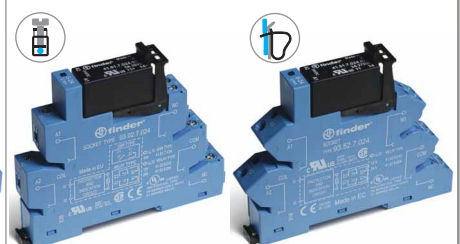

- Single solid state output:
Options 5A 24VDC, 3A 240VAC
- Silent, high speed switching
- Long electrical life

Page 5

Features

1 Pole - 6 A electromechanical relay interface modules, 6.2 mm wide.

Ideal interface for PLC and electronic systems

- Sensitive DC coil or AC/DC coil versions
- Integral coil indication and protection circuit
- Instant ejection of relay using plastic retaining clip
- UL Listing (certain relay/socket combinations)
- 35 mm rail (EN 60715) mounting

38.51 / 38.51.3
Screw terminal

38.61 / 38.61.3
Screwless terminal



* Special version for max ambient temperature +70°C.

For outline drawing see page 12

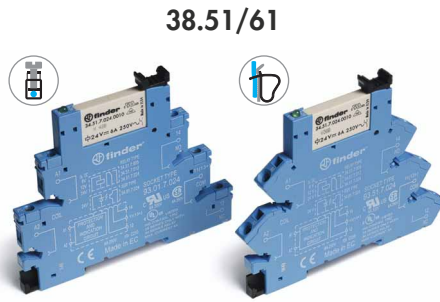

- 1 pole electromechanical relay
- Screw terminal and screwless terminal
- 35 mm rail (EN 60715) mounting

- Leakage current suppression
- 1 pole electromechanical relay
- Screw terminal and screwless terminal
- 35 mm rail (EN 60715) mounting

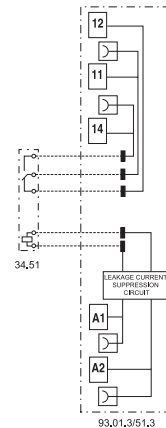
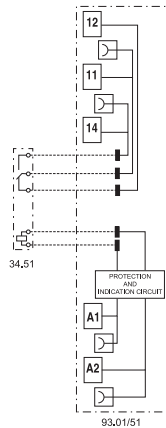

Contact specification

Contact configuration		1 CO (SPDT)	1 CO (SPDT)
Rated current/Maximum peak current	A	6/10	6/10
Rated voltage/Maximum switching voltage V AC		250/400	250/400
Rated load AC1	VA	1,500	1,500
Rated load AC15 (230 V AC)	VA	300	300
Single phase motor rating (230 V AC)	kW	0.185	0.185
Breaking capacity DC1: 30/110/220 V	A	6/0.2/0.12	6/0.2/0.12
Minimum switching load	mW (V/mA)	500 (12/10)	500 (12/10)
Standard contact material		AgNi	AgNi

Coil specification

Nominal voltage (U _N)	V AC/DC	12 - 24 - 48 - 60 - (110...125) - (220...240)	(110...125)	—
	V AC	(230...240)*	—	(230...240)
	V DC	6 - 12 - 24 - 48 - 60 (non polarized)	—	—
Rated power AC/DC	VA (50 Hz)/W	See page 9	1/1	0.5/—
Operating range	AC/DC	(0.8...1.1)U _N	(94...138)V	—
	AC	(184...264)V	—	(184...264)V
	DC	(0.8...1.2)U _N	—	—
Holding voltage	AC/DC	0.6 U _N / 0.6 U _N	0.6 U _N / 0.6 U _N	
Must drop-out voltage	AC/DC	0.1 U _N / 0.05 U _N	44 V	72 V

Technical data

Mechanical life AC/DC	cycles	10 · 10 ⁶	10 · 10 ⁶
Electrical life at rated load AC1	cycles	60 · 10 ³	60 · 10 ³
Operate/release time	ms	5/6	5/6
Insulation between coil and contacts (1.2/50 μs)	kV	6 (8 mm)	6 (8 mm)
Dielectric strength between open contacts	V AC	1,000	1,000
Ambient temperature range (U _N ≤ 60 V / >60V)	°C	-40...+70/-40...+55	-/-40...+55
Protection category		IP 20	IP 20

Approvals relay (according to type)



Features

Single output - solid state relay interface modules, 6.2 mm wide.

Ideal interface for PLC and electronic systems

- DC, AC or AC/DC input versions
- Supplied with integral coil indication and protection circuit
- Silent, high switching speed and long electrical life
- Instant ejection of relay using plastic retaining clip
- UL Listing (certain relay/socket combinations)
- 35 mm rail (EN 60715) mounting

B

38.81 / 38.81.3
Screw terminal

38.91 / 38.91.3
Screwless terminal



38.81/38.91



- AC or DC output switching
- SSR relay - DC input voltage
- Screw terminal and screwless terminal
- 35 mm rail (EN 60715) mounting

38.81.3/38.91.3



- Leakage current suppression
- AC or DC output
- SSR relay - AC or AC/DC input voltage
- Screw terminal and screwless terminal
- 35 mm rail (EN 60715) mounting

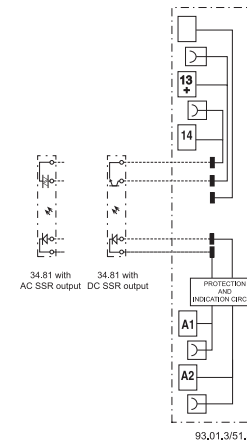
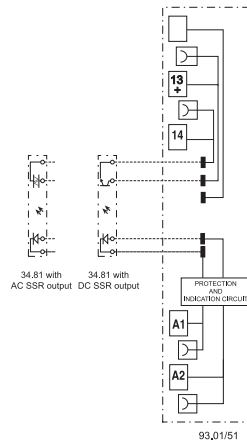

For outline drawing see page 12

Output specification		1 NO (SPST-NO)			1 NO (SPST-NO)		
Contact configuration		1 NO (SPST-NO)			1 NO (SPST-NO)		
Rated current/Maximum peak current (10 ms) A		2/20	0.1/0.5	2/40	2/20	0.1/0.5	2/40
Rated voltage/Maximum blocking voltage V		24/33 DC	48/60 DC	240/— AC	24/33 DC	48/60 DC	240/— AC
Switching voltage range V		(1.5...24)DC	(1.5...48)DC	(12...275)AC	(1.5...24)DC	(1.5...48)DC	(12...275)AC
Repetitive peak off-state voltage V _{pk}		—	—	600	—	—	600
Minimum switching current mA		1	0.05	22	1	0.05	22
Max. "OFF-state" leakage current mA		0.001	0.001	1.5	0.001	0.001	1.5
Max. "ON-state" voltage drop V		0.12	1	1.6	0.12	1	1.6
Input specification							
Nominal voltage (U _N)	V AC	—			230...240		
	V DC	6 - 24 - 60			—		
	V AC/DC	(110...125) - (220...240)			110...125		
Operating range	V DC	See page 10			See page 10		
Control current	mA	See page 10			See page 10		
Release voltage	V DC	See page 10			See page 10		
Technical data							
Operate/release time: ON/OFF (DC input) ms		0.2/0.6	0.04/0.11	12/12	0.2/0.6	0.04/0.11	12/12
Dielectric strength between input/output V AC		2,500			2,500		
Ambient temperature range °C		-20...+55			-20...+55		
Environmental protection		IP20			IP20		
Approvals relay (according to type)							

Features

Slim timed interface module, 6.2 mm wide.

- 1 pole, 6 A - electromechanical relay
- 1 output, 2 A DC or AC - solid state relay

- Electromechanical or solid state output
- Multi-functions timer
- AC/DC supply
- 4 time scales from 0.1s to 6h
- Instant ejection of relay using plastic retaining clip
- 6.2 mm wide, 35 mm rail (EN 60715) mounting

38.21
Screw terminal



For outline drawing see page 12

38.21

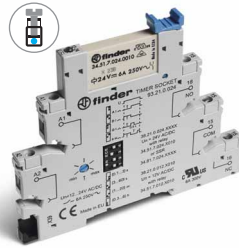

- 1 pole electromechanical output relay
- 12 or 24 V AC/DC supply
- Screw terminal
- 35 mm rail (EN 60715) mounting

A1: On-delay
D1: Interval
G1: Pulse delayed
SW: Symmetrical flasher (starting pulse on)

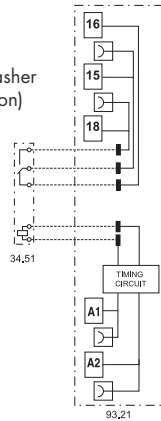

38.21...9024-8240



- DC or AC solid state output relays
- 24V AC/DC supply voltage
- Screw terminal
- 35 mm rail (EN 60715) mounting

A1: On-delay
D1: Interval
G1: Pulse delayed
SW: Symmetrical flasher (starting pulse on)

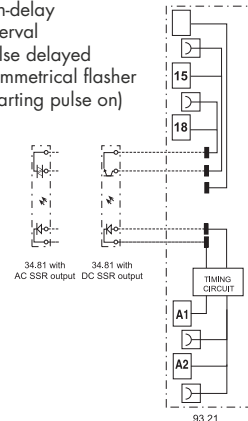

Contact specification			
Contact configuration		1 CO (SPDT)	—
Rated current/Maximum peak current	A	6/10	—
Rated voltage/Maximum switching voltage	V AC	250/400	—
Rated load AC1	VA	1,500	—
Breaking capacity DC1: 30/110/220 V	A	6/0.2/0.12	—
Minimum switching load	mW (V/mA)	500 (12/10)	—
Standard contact material		AgNi	—
Output specification		DC output (...9024)	AC output (...8240)
Output configuration		1 NO (SPST-NO)	1 NO (SPST-NO)
Rated current/Maximum peak current	A	2/20	2/40
Rated voltage/Maximum blocking voltage	V	(24/33)DC	(240/—)AC
Switching voltage range	V	(1.5...24)DC	(12...275)AC
Repetitive peak off-state voltage	V _{pk}	—	600
Minimum switching current	mA	1	22
Max. "OFF-state" leakage current	mA	0.001	1.5
Max. "ON-state" voltage drop	V	0.12	1.6
Supply specification			
Nominal voltage (U _N)	V AC (50/60Hz)/DC	12 - 24	24
Rated power	VA/W	0.5	0.5
Operating range	AC	(0.8...1.1)U _N	(0.8...1.1)U _N
	DC	(0.8...1.1)U _N	(0.8...1.1)U _N
Technical data			
Specified time range		(0.1...3)s, (3...60)s, (1...20)min, (0.3...6)h	
Repeatability	%	± 1	
Recovery time	ms	≤ 50	
Setting accuracy-full range	%	5%	
Ambient temperature	°C	-40...+70	-20...+55
Protection category		IP 20	
Approvals relay (according to type)			

Features

Electromechanical relay interface modules, 14 mm wide.

- 38.01 and 38.11 - 1 Pole 16 A
- 38.52 and 38.62 - 2 Pole 8 A

Ideal interface for PLC and electronic systems

- Sensitive DC coil or AC/DC coil versions
- Integral coil indication and protection circuit
- Instant ejection of relay using plastic retaining clip
- UL Listing (certain relay/socket combinations)
- 35 mm rail (EN 60715) mounting

B

38.01/52
Screw terminal



38.11/62
Screwless terminal



38.01/38.11

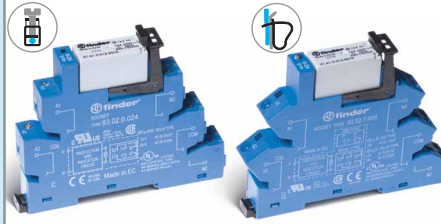

- Screw terminal and screwless terminal
- 1 pole electromechanical relay
- 35 mm rail (EN 60715) mounting

38.52/38.62

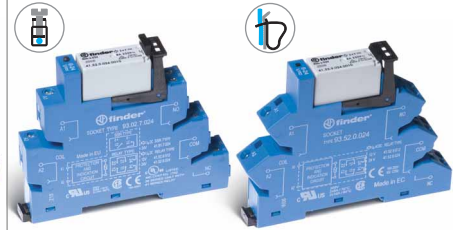

- Screw terminal and screwless terminal
- 2 pole electromechanical relay
- 35 mm rail (EN 60715) mounting

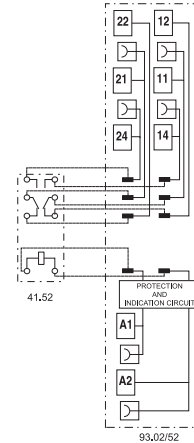
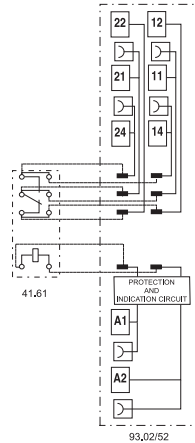

* For currents >10 A, contact terminals must be connected in parallel (21 with 11, 24 with 14, 22 with 12).

For outline drawing see page 12

Contact specification

Contact configuration		1 CO (DPDT)	2 CO (DPDT)
Rated current/Maximum peak current	A	16*/30	8/15
Rated voltage/Maximum switching voltage	V AC	250/400	250/400
Rated load AC1	VA	4,000	2,000
Rated load AC15 (230 V AC)	VA	750	400
Single phase motor rating (230 V AC)	kW	0.5	0.3
Breaking capacity DC1: 30/110/220 V	A	16/0.3/0.12	8/0.3/0.12
Minimum switching load	mW (V/mA)	300 (5/5)	300 (5/5)
Standard contact material		AgNi	AgNi

Coil specification

Nominal voltage (U_N)	V AC/DC	24 - 60 - (110...125) - (220...240)	24 - 60 - (110...125) - (220...240)
	V AC	230...240	230...240
	V DC	12 - 24 - 60	12 - 24 - 60
Rated power AC/DC	VA (50 Hz)/W	See page 9	See page 9
Operating range	AC/DC	0.8...1.1	0.8...1.1
	DC	(0.8...1.2) U_N	(0.8...1.2) U_N
Holding voltage	AC/DC	0.6 / 0.6 U_N	0.6 / 0.6 U_N
Must drop-out voltage	AC/DC	0.1 / 0.05 U_N	0.1 / 0.05 U_N

Technical data

Mechanical life AC/DC	cycles	10 · 10 ⁶	10 · 10 ⁶
Electrical life at rated load AC1	cycles	50 · 10 ³	60 · 10 ³
Operate/release time	ms	8 / 10	8 / 10
Insulation between coil and contacts (1.2/50 μ s)	kV	6 (8 mm)	6 (8 mm)
Dielectric strength between open contacts	V AC	1,000	1,000
Ambient temperature range ($U_N \leq 60$ V / >60V)	°C	-40...+70 / -40...+55	-40...+70 / -40...+55
Protection category		IP 20	IP 20

Approvals relay (according to type)



Features

Single output - solid state relay interface modules, 14 mm wide.

Ideal interface for PLC and electronic systems

- DC input versions
- Supplied with integral coil indication and protection circuit
- Silent, high switching speed and long electrical life
- Instant ejection of relay using plastic retaining clip
- UL Listing (certain relay/socket combinations)
- 35 mm rail (EN 60715) mounting

38.31
Screw terminal



38.41
Screwless terminal



38.31/38.41

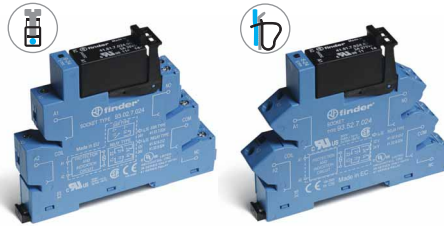

- Screw terminal and screwless terminal
- AC or DC output switching
- SSR relay - DC input voltage
- 35 mm rail (EN 60715) mounting

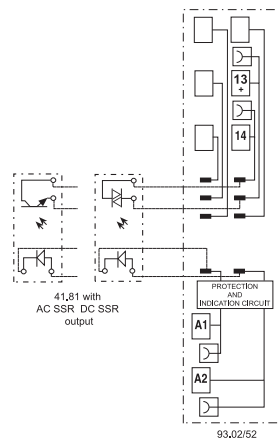

For outline drawing see page 12

Output specification		38.31	38.41
Contact configuration		1 NO (SPST-NO)	1 NO (SPST-NO)
Rated current/Maximum peak current (10 ms) A		5/40	3/40
Rated voltage/Maximum blocking voltage V		(24/35)DC	(240/—)AC
Switching voltage range V		(1.5...24)DC	(12...275)AC
Repetitive peak off-state voltage V_{pk}		—	600
Minimum switching current mA		1	50
Max. "OFF-state" leakage current mA		0.01	1
Max. "ON-state" voltage drop V		0.3	1.1
Input specification			
Nominal voltage (U_N)	V AC/DC	24	
	V DC	12 - 24	
Operating range	V DC	See page 10	
Control current	mA	See page 10	
Release voltage	V DC	See page 10	
Technical data			
Operate/release time: ON/OFF (DC input) ms		0.05/0.25	12/12
Dielectric strength between input/output V AC		2,500	
Ambient temperature range °C		-20...+55	
Environmental protection		IP20	
Approvals relay (according to type)			

B

Ordering information

Electromechanical relay - 1 or 2 Pole

Example: 38 series screw terminal relay interface module, 1 CO (SPDT), sensitive 12 V DC coil.

B

3
8
.
5
1
.
7
.
0
1
2
.
0
0
.
5
0

A

B

C

D

Series _____

Type _____

0 = Electromechanical 16 A relay, with screw terminal

1 = Electromechanical 16 A relay, with screwless terminal

2 = Timer multifunction (AI, DI, GI, SW), with screw terminal

5 = Electromechanical relay, with screw terminal

6 = Electromechanical relay, with screwless terminal

No. of poles _____

1 = 1 pole, 6 or 16 A

2 = 2 pole, 8 A

Coil version _____

0 = AC (50/60 Hz)/ DC

3 = Leakage current suppression for (110...125)V AC/DC - (230...240)V AC

7 = Sensitive DC, (6, 12, 24, 48, 60)V only

8 = AC (50/60 Hz)

Coil voltage _____

See coil specifications

D: Special versions
0 = Standard

C: Options
5 = Standard DC
6 = Standard AC or AC/DC

B: Contact circuit
0 = CO (nPDT)

A: Contact material
0 = AgNi Standard
4 = AgSnO₂
5 = AgNi + Au

Selecting features and options: only combinations in the same row are possible.

Type	Coil version	A	B	C	D
38.01/11	7	0 - 4	0	5	0
38.01/11	0 - 8	0 - 4	0	6	0
38.51/61	7	0 - 4 - 5	0	5	0
38.51/61	0 - 3 - 8	0 - 4 - 5	0	6	0
38.52/62	7	0 - 5	0	5	0
38.52/62	0 - 8	0 - 5	0	6	0
38.21	0	0	0	6	0

Ordering information

Solid state relay - Single output - 6.2 & 14 mm wide

Example: 38 series screw terminal SSR relay interface module, 6.2 mm wide, 2 A output, 24 V DC input.

3 8 . 8 1 . 7 . 0 2 4 . 9 0 2 4

Series

Type

- 21 = Timer SSR 6.2mm wide, with screw terminal
- 31 = SSR 14mm wide, with screw terminal
- 41 = SSR 14mm wide, with screwless terminal
- 81 = SSR 6.2mm wide, with screw terminal
- 91 = SSR 6.2mm wide, with screwless terminal

Input version

- 0 = AC/DC
- 3 = Leakage current suppression for (110...125)V AC/DC and (230...240)V AC SSR only
- 7 = DC, (6, 24, 60)V SSR only

Input voltage

See input specifications

Output version

- 9024 = 2 A - 24 V DC (38.21, 38.81 & 38.91)
- 9024 = 5 A - 24 V DC (38.31 & 38.41)
- 7048 = 0.1 A - 48 V DC (38.81 & 38.91)
- 8240 = 2 A - 240 V AC (38.21, 38.81 & 38.91)
- 8240 = 3 A - 240 V AC (38.31 & 38.41)



Selecting features and options: only combinations in the same row are possible.

Type	Input version	Output version
38.81/91	7	9024 - 7048 - 8240
38.81/91	0 - 3	9024 - 7048 - 8240
38.31/41	0 - 7	9024 - 8240
38.21	0	9024 - 8240

Technical data - 1 & 2 Pole Electromechanical Relays

Insulation				
Insulation according to EN 61810-1	insulation rated voltage	V	250	400
	rated impulse withstand voltage	kV	4	4
	pollution degree		3	2
	overvoltage category		III	III
Insulation between coil and contacts (1.2/50 μ s)		kV	6 (8 mm)	
Dielectric strength between open contacts		V AC	1,000	
Conducted disturbance immunity				
Burst (5...50)ns, 5 kHz, on A1 - A2			EN 61000-4-4	level 4 (4 kV)
Surge (1.2/50 μ s) on A1 - A2 (differential mode)			EN 61000-4-5	level 3 (2 kV)
Other data			1 Pole 6 A	1 Pole 16 A - 2 Pole 8 A
Bounce time: NO/NC		ms	1/6	2/5
Vibration resistance (10...55)Hz: NO/NC		g	10/5	15/2
Power lost to the environment	without contact current	W	0.2 (12 V) - 0.9 (240 V)	
	with rated current	W	0.5 (12 V) - 1.5 (240 V)	
			38.21 / 38.51	38.61
Terminals				
Wire strip length		mm	10	
⊖ Screw torque		Nm	0.5	
Max. wire size			solid cable	stranded cable
		mm ²	1x2.5/2x1.5	1x2.5
		AWG	1x14/2x16	1x14
			38.01 / 38.52	38.11 / 38.62
Wire strip length		mm	10	
⊖ Screw torque		Nm	0.5	
Max. wire size			solid cable	stranded cable
		mm ²	1x2.5/2x1.5	1x2.5
		AWG	1x14/2x16	1x14

Contact specification - 1 & 2 Pole Electromagnetic Relays

F 38 - Electrical life (AC) v contact current, 1 Pole 6 A

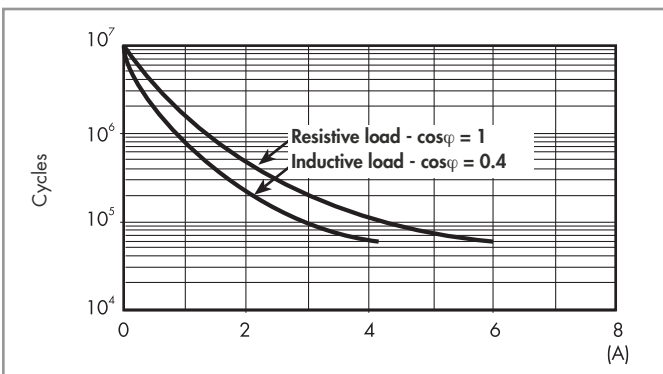

H 38 - Maximum DC1 breaking capacity, 1 Pole 6 A

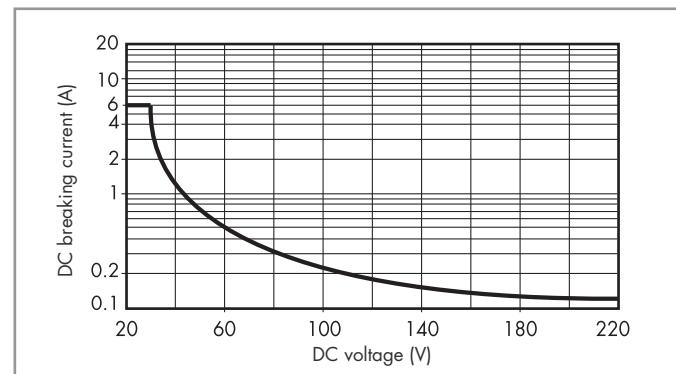

F 38 - Electrical life (AC) v contact current, 1 Pole 16 A and 2 Pole 8 A

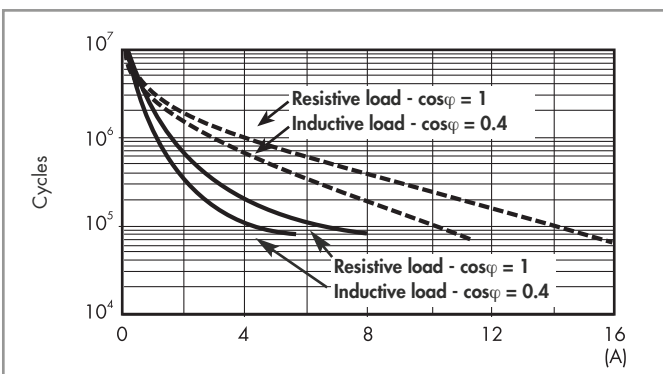

H 38 - Maximum DC1 breaking capacity, 1 Pole 16 A and 2 Pole 8 A

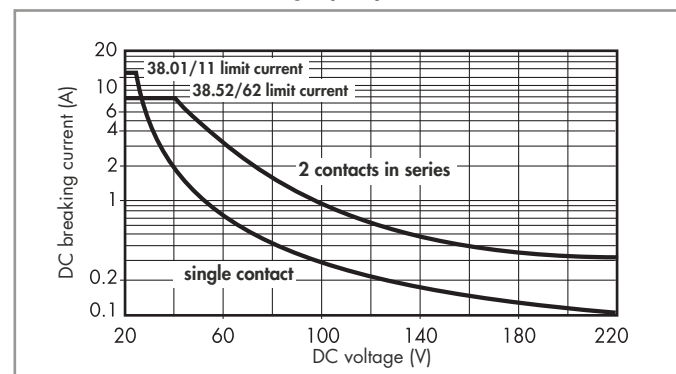

———— : 2 Pole 8 A
- - - - - : 1 Pole 16 A

- When switching a resistive load (DC1) having voltage and current values under the curve, an electrical life of $\geq 60 \cdot 10^3$ (1 Pole) or $\geq 80 \cdot 10^3$ (2 Pole) can be expected.
- In the case of DC13 loads, the connection of a diode in parallel with the load will permit a similar electrical life as for a DC1 load. Note: the release time for the load will be increased.

Coil specifications - 1 Pole 6 A Electromechanical Relay

Coil data sensitive DC, 1 Pole

Nominal voltage U_N V	Coil code	Operating range		Rated coil consumption I at U_N mA	Power consumption P at U_N W
		U_{min} V	U_{max} V		
6	7.006	4.8	7.2	35	0.2
12	7.012	9.6	14.4	15.2	0.2
24	7.024	19.2	28.8	10.4	0.3
48	7.048	38.4	57.6	6.3	0.3
60	7.060	48	72	7	0.4

Coil data AC/DC, 1 Pole

Nominal voltage U_N V	Coil code	Operating range		Rated coil consumption I at U_N mA	Power consumption P at U_N VA/W
		U_{min} V	U_{max} V		
12	0.012	9.6	13.2	16	0.2/0.2
24	0.024	19.2	26.4	12	0.3/0.2
48	0.048	38.4	52.8	6.9	0.3/0.3
60	0.060	48	66	7	0.5/0.5
110...125	0.125	88	138	5(*)	0.6/0.6(*)
220...240	0.240	176	264	4(*)	1/0.9(*)

(*) Rated coil consumption and power consumption values relate to $U_N = 125$ and 240 V.

Coil data AC, 1 Pole (indicated for max ambient temperature +70°C)

Nominal voltage U_N V	Coil code	Operating range		Rated coil consumption I at U_N mA	Power consumption P at U_N VA/W
		U_{min} V	U_{max} V		
(230...240) AC	8.240	184	264	3	0.7/0.3

Coil data, leakage current suppression types, 1 Pole

Nominal voltage U_N V	Coil code	Operating range		Rated coil consumption I at U_N mA	Power consumption P at U_N VA/W
		U_{min} V	U_{max} V		
(110...125) AC/DC	3.125	94	138	8(*)	1/1(*)
(230...240) AC	3.240	184	264	7(*)	1.7/0.5(*)

(*) Rated coil consumption and power consumption values relate to $U_N = 125$ and 240 V.

The 38 Series interface modules (supply version 3) have built-in leakage current suppression to address industry concerns of the contacts not dropping-out when there is residual current in the circuit; at (110...125)V AC and (230...240)V AC.

This problem can occur, for example, when connecting the interface modules to PLC,s with triac outputs or when connecting via relatively long cables.

Coil specifications - 1 Pole 16 A and 2 Pole 8 A Electromechanical Relay

Coil data sensitive DC, 1 Pole 16 A and 2 Pole 8 A

Nominal voltage U_N V	Coil code	Operating range		Rated coil consumption I at U_N mA	Power consumption P at U_N W
		U_{min} V	U_{max} V		
12	7.012	9.6	14.4	41	0.5
24	7.024	19.2	28.8	19.5	0.5
60	7.060	48	72	8	0.5

Coil data AC/DC, 1 Pole 16 A and 2 Pole 8 A

Nominal voltage U_N V	Coil code	Operating range		Rated coil consumption I at U_N mA	Power consumption P at U_N VA/W
		U_{min} V	U_{max} V		
24	0.024	19.2	26.4	20	0.5/0.5
60	0.060	48	66	7.1	0.5/0.5
110...125	0.125	88	138	4.6	0.6/0.6
220...240	0.240	184	264	3.8	0.9/0.9

Coil data AC, 1 Pole 16 A and 2 Pole 8 A

Nominal voltage U_N V	Coil code	Operating range		Rated coil consumption I at U_N mA	Power consumption P at U_N VA/W
		U_{min} V	U_{max} V		
230...240	8.230	184	264	5.3	1.2/0.6

Coil specification - 1 & 2 Pole Electromagnetic Relays

R 38 - DC coil operating range v ambient temperature
1 Pole and 2 Pole

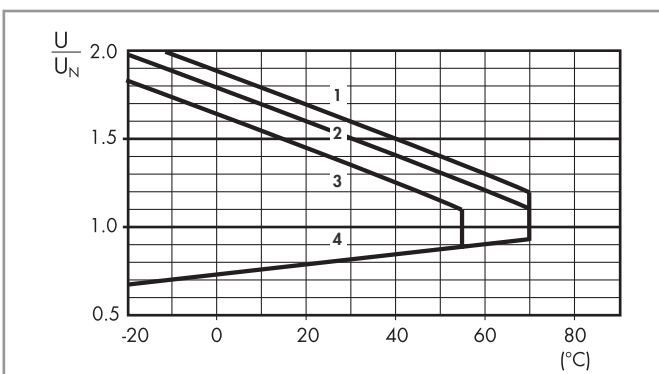

- 1 - Max. permitted coil voltage at nominal load (DC coil).
- 2 - Max. permitted coil voltage at nominal load (AC/DC coils $U \leq 60$ V).
- 3 - Max. permitted coil voltage at nominal load (AC/DC coils $U > 60$ V).
- 4 - Min pick-up voltage with coil at ambient temperature.

Technical data - Solid State Relays

Other data			38.81/38.91		38.31/38.41	
Power lost to the environment	without output current	W	0.25 (24 V DC)		0.5	
	with rated current	W	0.4		2.2 (DC output) / 3 (AC output)	
Terminals			38.81		38.91	
Wire strip length		mm	10		10	
⊖ Screw torque		Nm	0.5		—	
Max. wire size			solid cable	stranded cable	solid cable	stranded cable
		mm ²	1x2.5 / 2x1.5		1x2.5	
		AWG	1x14 / 2x16		1x14	
			38.31		38.41	
Wire strip length		mm	10		10	
⊖ Screw torque		Nm	0.5		—	
Max. wire size			solid cable	stranded cable	solid cable	stranded cable
		mm ²	1x2.5 / 2x1.5		1x2.5	
		AWG	1x14 / 2x16		1x14	

Input specifications - Solid State Relays type 38.81 and 38.91 - 6.2 mm wide

Input data DC

Nominal voltage U _N	Supply code	Operating range		Release voltage U	Rated coil consumption I at U _N	Power consumption P
		U _{min}	U _{max}			
V		V	V	V	mA	W
6	7.006	5	7.2	2.4	7	0.2
24	7.024	16.8	30	10	10.5	0.3
60	7.060	35.6	72	20	6.5	0.4

Input data - Leakage current suppression types

Nominal voltage U _N	Supply code	Operating range		Release voltage U	Rated coil consumption I at U _N	Power consumption P at U _N
		U _{min}	U _{max}			
V		V	V	V	mA	W
110...125 AC/DC	3.125	94	138	44	8(*)	1/1(*)
230...240 AC	3.240	184	264	72	6.5(*)	1.6/0.6(*)

(*) Rated coil consumption and power consumption values relate to U_N = 125 and 240 V.

Input data AC/DC

Nominal voltage U _N	Supply code	Operating range		Release voltage U	Rated coil consumption I at U _N	Power consumption P
		U _{min}	U _{max}			
V		V	V	V	mA	VA/W
110...125	0.125	88	138	22	5.5*	0.7/0.7
220...240	0.240	184	264	44	3.5*	1/0.9

(*) Rated coil consumption and power consumption values relate to U_N = 125 and 240 V.

The 38 Series interface modules (supply version 3) have built-in leakage current suppression to address industry concerns of the contacts not dropping-out when there is residual current in the circuit; at (110...125)V AC and (230...240)V AC.

This problem can occur, for example, when connecting the interface modules to PLC,s with triac outputs or when connecting via relatively long cables.

Input specification - Solid State Relay types 38.31 and 38.41 - 14 mm wide

Input data DC

Nominal voltage U _N	Supply code	Operating range		Release voltage U	Rated coil consumption I at U _N	Power consumption P
		U _{min}	U _{max}			
V		V	V	V	mA	W
12	7.012	9.6	18	5	9	0.2
24	7.024	16.8	30	5	12	0.3

Input data AC/DC

Nominal voltage U _N	Supply code	Operating range		Release voltage U	Rated coil consumption I at U _N	Power consumption P
		U _{min}	U _{max}			
V		V	V	V	mA	W
24	0.024	16.8	30	9	16.5	0.3

Additional technical data - Timed Interface Module

EMC specifications			
Type of test		Reference standard	
Electrostatic discharge	contact discharge	EN 61000-4-2	4 kV
	air discharge	EN 61000-4-2	8 kV
Radio-frequency electromagnetic field (80 ÷ 1,000 MHz)		EN 61000-4-3	10 V/m
Fast transients (burst) (5-50 ns, 5 kHz) on Supply terminals		EN 61000-4-4	4 kV
Surges (1.2/50 µs) on Supply terminals	common mode	EN 61000-4-5	4 kV
	differential mode	EN 61000-4-5	4 kV
Radio-frequency common mode (0.15 ÷ 80 MHz) on Supply terminals		EN 61000-4-6	10 V
Radiated and conducted emission		EN 55022	class B
Other data		EMR	SSR
Power lost to the environment	without contact current	W	0.1
	with rated current	W	0.5
Terminals		38.21	
Wire strip length	mm	10	
Screw torque	Nm	0.5	
Max. wire size		solid cable	stranded cable
	mm ²	1x2.5 / 2x1.5	1x2.5 / 2x1.5
	AWG	1x14 / 2x16	1x14 / 2x16

Times scales

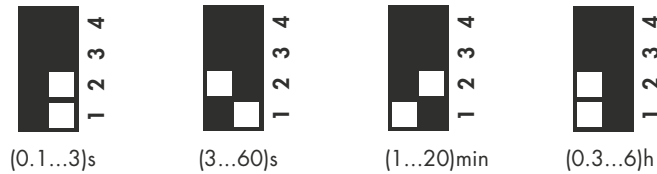

Functions

LED	Supply voltage	NO contact/output
	OFF	Open
	ON	Open (time in progress)
	ON	Closed

Wiring diagram

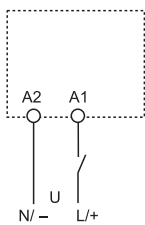

U = Supply voltage

= Output contact

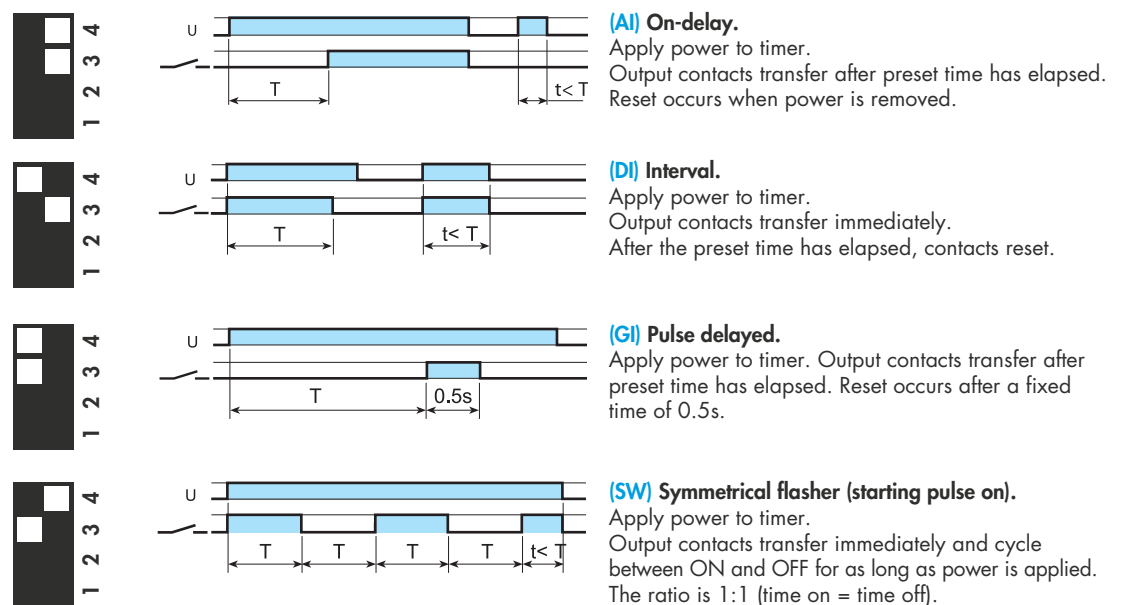

Outline drawings

38.21
38.51 / 38.51.3
38.81 / 38.81.3
Screw terminal

38.01
38.31
38.52
Screw terminal

B

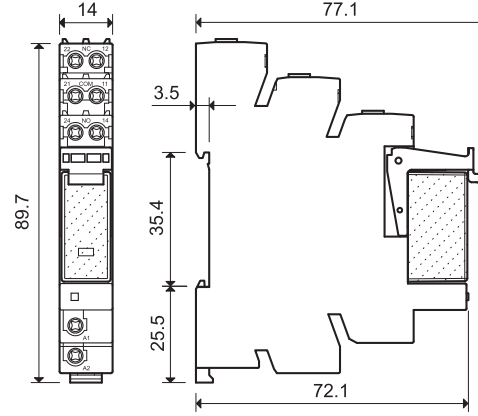
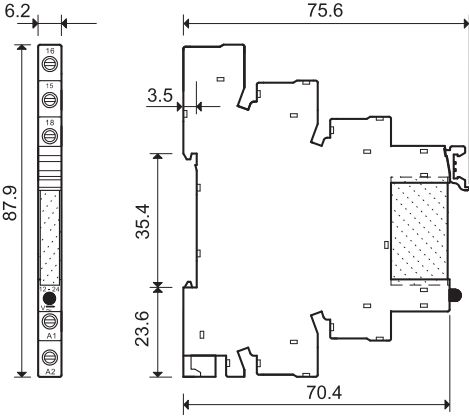

38.61 / 38.61.3
38.91 / 38.91.3
Screwless terminal

38.11
38.41
38.62
Screwless terminal

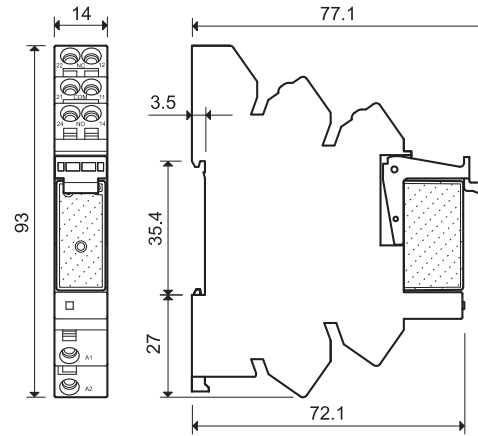
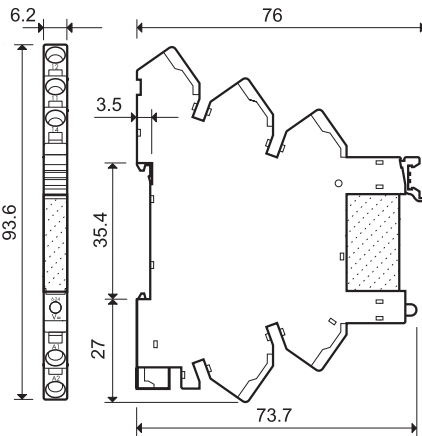

Electromechanical Relay & Socket Combinations

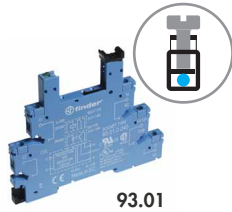

93.01

Screw terminal - 1 Pole relay 6 A

Interface Module Code	Coil voltage	Relay	Socket
38.51.0.012.0060	12 V AC/DC	34.51.7.012.0010	93.01.0.024
38.51.0.024.0060	24 V AC/DC	34.51.7.024.0010	93.01.0.024
38.51.0.048.0060	48 V AC/DC	34.51.7.048.0010	93.01.0.060
38.51.0.060.0060	60 V AC/DC	34.51.7.060.0010	93.01.0.060
38.51.0.125.0060	(110...125)V AC/DC	34.51.7.060.0010	93.01.0.125
38.51.0.240.0060	(220...240)V AC/DC	34.51.7.060.0010	93.01.0.240
38.51.3.125.0060	(110...125)V AC/DC	34.51.7.060.0010	93.01.3.125
38.51.3.240.0060	(230...240)V AC	34.51.7.060.0010	93.01.3.240
38.51.7.006.0050	6 V DC	34.51.7.005.0010	93.01.7.024
38.51.7.012.0050	12 V DC	34.51.7.012.0010	93.01.7.024
38.51.7.024.0050	24 V DC	34.51.7.024.0010	93.01.7.024
38.51.7.048.0050	48 V DC	34.51.7.048.0010	93.01.7.060
38.51.7.060.0050	60 V DC	34.51.7.060.0010	93.01.7.060
38.51.8.240.0060	(230...240)V AC	34.51.7.060.0010	93.01.8.240



93.51

Screwless terminal - 1 Pole relay 6 A

Interface Module Code	Coil voltage	Relay	Socket
38.61.0.012.0060	12 V AC/DC	34.51.7.012.0010	93.51.0.024
38.61.0.024.0060	24 V AC/DC	34.51.7.024.0010	93.51.0.024
38.61.0.125.0060	(110...125)V AC/DC	34.51.7.060.0010	93.51.0.125
38.61.0.240.0060	(220...240)V AC/DC	34.51.7.060.0010	93.51.0.240
38.61.3.125.0060	(110...125)V AC/DC	34.51.7.060.0010	93.51.3.125
38.61.3.240.0060	(230...240)V AC	34.51.7.060.0010	93.51.3.240
38.61.7.012.0050	12 V DC	34.51.7.012.0010	93.51.7.024
38.61.7.024.0050	24 V DC	34.51.7.024.0010	93.51.7.024
38.61.8.240.0060	(230...240)V AC	34.51.7.060.0010	93.51.8.240



93.02

Screw terminal - 1 Pole relay 16 A

Interface Module Code	Coil voltage	Relay	Socket
38.01.7.012.0050	12 V DC	41.61.9.012.0010	93.02.7.024
38.01.7.024.0050	24 V DC	41.61.9.024.0010	93.02.7.024
38.01.7.060.0050	60 V DC	41.61.9.060.0010	93.02.7.060
38.01.0.024.0060	24 V AC/DC	41.61.9.024.0010	93.02.0.024
38.01.0.060.0060	60 V AC/DC	41.61.9.060.0010	93.02.0.060
38.01.0.125.0060	125 V AC/DC	41.61.9.110.0010	93.02.0.125
38.01.0.240.0060	240 V AC/DC	41.61.9.110.0010	93.02.0.240
38.01.8.230.0060	230 V AC	41.61.9.110.0010	93.02.8.230



93.52

Screwless terminal - 1 Pole relay 16 A

Interface Module Code	Coil voltage	Relay	Socket
38.11.7.012.0050	12 V DC	41.61.9.012.0010	93.52.7.024
38.11.7.024.0050	24 V DC	41.61.9.024.0010	93.52.7.024
38.11.7.060.0050	60 V DC	41.61.9.060.0010	93.52.7.060
38.11.0.024.0060	24 V AC/DC	41.61.9.024.0010	93.52.0.024
38.11.0.060.0060	60 V AC/DC	41.61.9.060.0010	93.52.0.060
38.11.0.125.0060	125 V AC/DC	41.61.9.110.0010	93.52.0.125
38.11.0.240.0060	240 V AC/DC	41.61.9.110.0010	93.52.0.240
38.11.8.230.0060	230 V AC	41.61.9.110.0010	93.52.8.230

Approvals (according to type):



UL US Certain relay/socket combinations

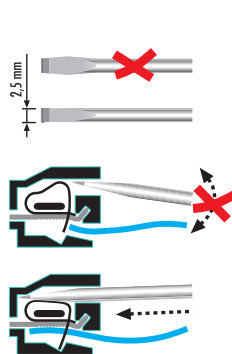

Screw terminal - 2 Pole relay 8 A

Interface Module Code	Coil voltage	Relay	Socket
38.52.0.024.0060	24 V AC/DC	41.52.9.024.0010	93.02.0.024
38.52.0.060.0060	60 V AC/DC	41.52.9.060.0010	93.02.0.060
38.52.0.125.0060	(110...125)V AC/DC	41.52.9.110.0010	93.02.0.125
38.52.0.240.0060	(220...240)V AC/DC	41.52.9.110.0010	93.02.0.240
38.52.7.012.0050	12 V DC	41.52.9.012.0010	93.02.7.024
38.52.7.024.0050	24 V DC	41.52.9.024.0010	93.02.7.024
38.52.7.060.0050	60 V DC	41.52.9.060.0010	93.02.7.060
38.52.8.230.0060	(230...240)V AC	41.52.9.110.0010	93.02.8.230

Screwless terminal - 2 Pole relay 8 A

Interface Module Code	Coil voltage	Relay	Socket
38.62.0.024.0060	24 V AC/DC	41.52.9.024.0010	93.52.0.024
38.62.0.060.0060	60 V AC/DC	41.52.9.060.0010	93.52.0.060
38.62.0.125.0060	(110...125)V AC/DC	41.52.9.110.0010	93.52.0.125
38.62.0.240.0060	(220...240)V AC/DC	41.52.9.110.0010	93.52.0.240
38.62.7.012.0050	12 V DC	41.52.9.012.0010	93.52.7.024
38.62.7.024.0050	24 V DC	41.52.9.024.0010	93.52.7.024
38.62.7.060.0050	60 V DC	41.52.9.060.0010	93.52.7.060
38.62.8.230.0060	(230...240)V AC	41.52.9.110.0010	93.52.8.230

B

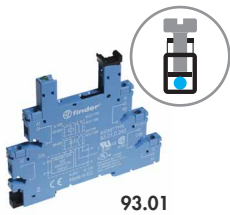

93.01

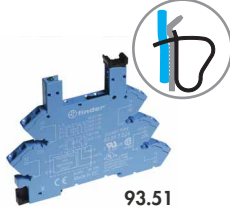

93.51

Approvals
(according to type):



Certain relay/socket combinations

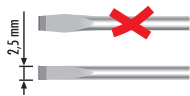

Solid State Relay & Socket Combinations - 6.2 mm wide

Screw terminal

Interface Module Code	Input voltage	Relay	Socket
38.81.7.006.xxxx	6 V DC	34.81.7.005.xxxx	93.01.7.024
38.81.7.024.xxxx	24 V DC	34.81.7.024.xxxx	93.01.7.024
38.81.7.060.xxxx	60 V DC	34.81.7.060.xxxx	93.01.7.060
38.81.0.125.xxxx	(110...125)V AC/DC	34.81.7.060.xxxx	93.01.0.125
38.81.0.240.xxxx	(220...240)V AC/DC	34.81.7.060.xxxx	93.01.0.240
38.81.3.125.xxxx	(110...125)V AC/DC	34.81.7.060.xxxx	93.01.3.125
38.81.3.240.xxxx	(230...240)V AC	34.81.7.060.xxxx	93.01.3.240

Screwless terminal

Interface Module Code	Input voltage	Relay	Socket
38.91.7.006.xxxx	6 V DC	34.81.7.005.xxxx	93.51.7.024
38.91.7.024.xxxx	24 V DC	34.81.7.024.xxxx	93.51.7.024
38.91.7.060.xxxx	60 V DC	34.81.7.060.xxxx	93.51.7.060
38.91.0.125.xxxx	(110...125)V AC/DC	34.81.7.060.xxxx	93.51.0.125
38.91.0.240.xxxx	(220...240)V AC/DC	34.81.7.060.xxxx	93.51.0.240
38.91.3.125.xxxx	(110...125)V AC/DC	34.81.7.060.xxxx	93.51.3.125
38.91.3.240.xxxx	(230...240)V AC	34.81.7.060.xxxx	93.51.3.240

Example: .xxxx

.9024

.7048

.8240



93.52

Approvals
(according to type):



Solid State Relay & Socket Combinations - 14 mm wide

Screw terminal

Interface Module Code	Input voltage	Relay	Socket
38.31.0.024.xxxx	24 V AC/DC	41.81.7.024.xxxx	93.02.0.024
38.31.7.012.xxxx	12 V DC	41.81.7.012.xxxx	93.02.7.024
38.31.7.024.xxxx	24 V DC	41.81.7.024.xxxx	93.02.7.024

Screwless terminal

Interface Module Code	Input voltage	Relay	Socket
38.41.0.024.xxxx	24 V AC/DC	41.81.7.024.xxxx	93.52.0.024
38.41.7.012.xxxx	12 V DC	41.81.7.012.xxxx	93.52.7.024
38.41.7.024.xxxx	24 V DC	41.81.7.024.xxxx	93.52.7.024



93.21

Approvals
(according to type):



SSR / EMR & Timer Socket Combinations

Screw terminal

Interface Module Code	Input / Coil voltage	Relay	Socket
38.21.0.012.0060	12 V AC/DC	34.51.7.012.0010	93.21.0.024
38.21.0.024.0060	24 V AC/DC	34.51.7.024.0010	93.21.0.024
38.21.0.024.xxxx	24 V AC/DC	34.81.7.024.xxxx	93.21.0.024

Accessories

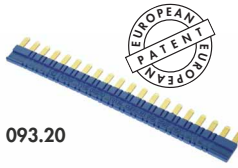

093.20

Approvals
(according to type):



20-way jumper link for 38.21/51/61/81/91	093.20 (blue)	093.20.0 (black)	093.20.1 (red)
Rated values	36 A - 250 V		

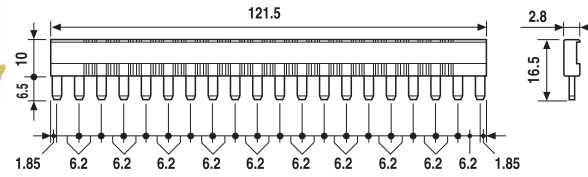

093.08

Approvals
(according to type):



8-way jumper link for 38.01/11/31/41/52/62	093.08 (blue)	093.08.0 (black)	093.08.1 (red)
Rated values	10 A - 250 V		

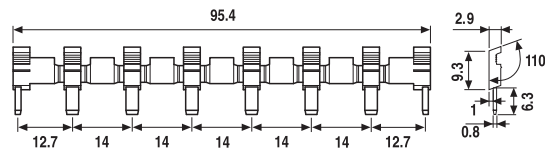

093.01

Plastic separator	093.01
--------------------------	--------

Thickness 2 mm, required at the start and the end of a group of interfaces.
Can be used for visual separation group, must be used for:
- protective separation of different voltages of neighbouring PLC interfaces according to VDE 0106-101
- protection of cut jumper links

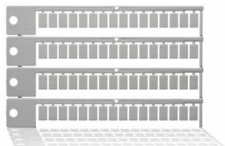

093.64

Sheet of marker tags for 38.21/51/61/81/91, plastic, 64 tags, 6x10 mm	093.64
--	--------

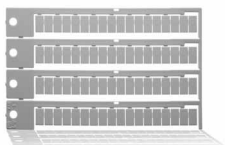

060.72

Sheet of marker tags for 38.01/11/31/41/52/62, plastic, 72 tags, 6x12 mm	060.72
---	--------

