

TLK10034 Quad-Channel XAUI/10GBASE-KR Transceiver Evaluation Module (EVM)

This user's guide describes the usage and construction of the TLK10034 evaluation module (EVM). This document provides guidance on proper use by showing some device configurations and test modes. In addition, design, layout, and schematic information is provided. Use the information in this guide when choosing the optimal design methods and materials in designing a complete system.

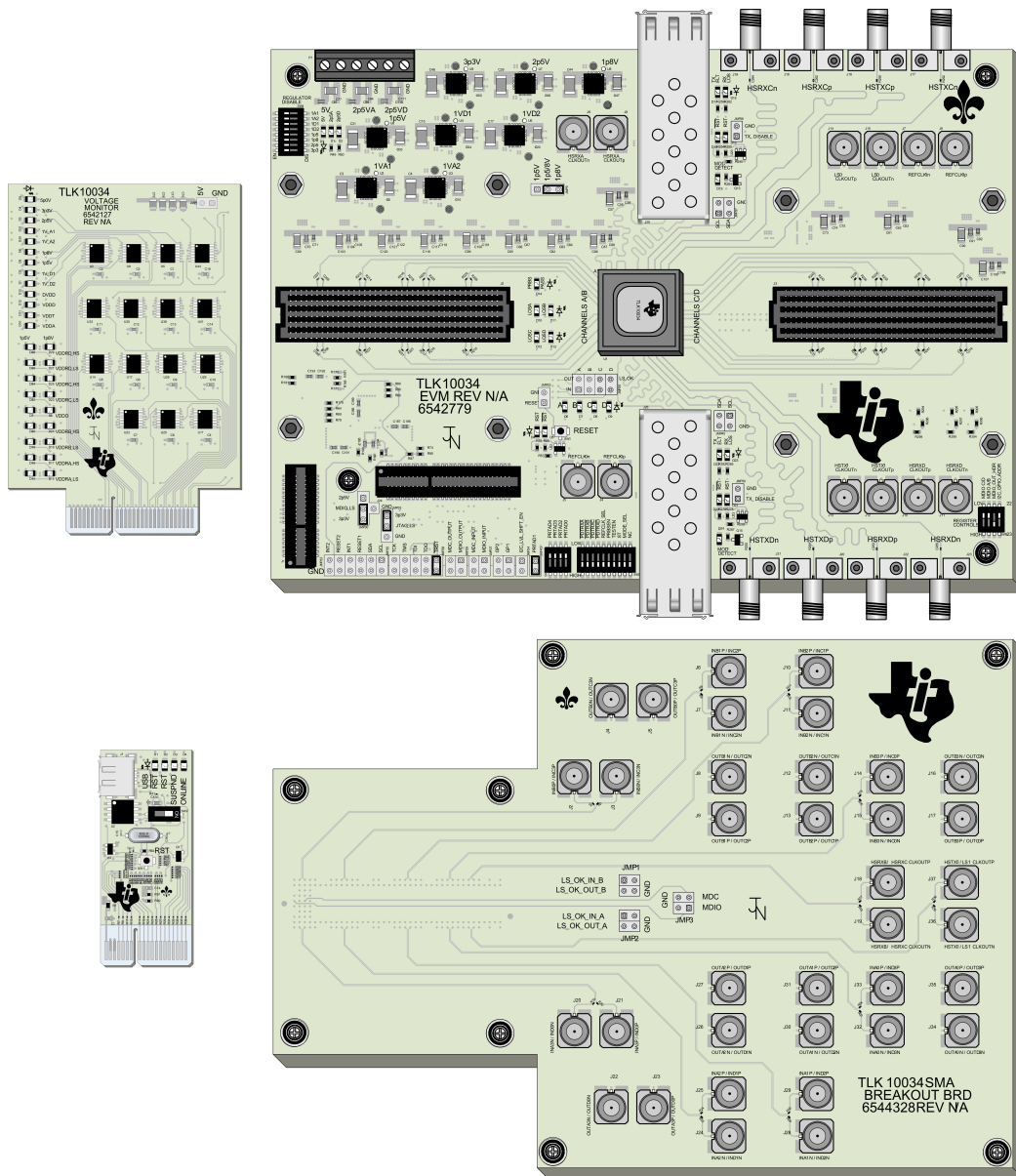

WARNING

This equipment is intended for use in a laboratory test environment only. It generates, uses, and can radiate radio frequency energy and has not been tested for compliance with the limits of computing devices pursuant to subpart J of part 15 of FCC rules, which are designed to provide reasonable protection against radio frequency interference. Operation of this equipment in other environments may cause interference with radio communications, in which case the user, at their own expense, is required to take whatever measures necessary to correct this interference.

Contents

1	Introduction	4
2	EVM PCB and High-Speed Design Considerations	5
3	TLK10034 EVM Kit Contents	5
4	Power	6
5	Voltage-Monitoring Board and Power-Rail LEDs	6
6	Control and Output Status Signals	7
7	MDIO	7
8	JTAG	8
9	Reset	8
10	Test and Setup Configurations	9
11	TLK10034 EVM Motherboard Schematics	17
12	TLK10034 EVM Motherboard Layout	33
13	TLK10034 EVM SMA Breakout Board Schematics	46
14	TLK10034 EVM SMA Breakout Board Layout	50
15	TLK10034 EVM Voltage-Monitor Board Schematics	55
16	TLK10034 EVM Voltage Monitor Board Layout	65
17	TLK10034 EVM USB Dongle Board Schematics	70
18	TLK10034 EVM USB Dongle Board Layout	72

List of Figures

1	TLK10034 EVM Motherboard	10
2	TLK10034 EVM SMA Breakout Board.....	11
3	TLK10034 EVM Voltage Monitor Board	12
4	TLK10034 EVM USB Dongle Board	13
5	TLK10034 EVM Motherboard and SMA Breakout Board for Channels C/D.....	14
6	TLK10034 EVM Motherboard and SMA Breakout Board for Channels A/B.....	15
7	TLK10034 EVM Motherboard Features	16
8	TLK10034 EVM Schematic, Cover Page and Index (Sheet 1 of 16)	17
9	TLK10034 EVM Schematic, 1p0V Analog Regulators (Sheet 2 of 16).....	18
10	TLK10034 EVM Schematic, 1p5V, 1p8V, 2p5V, And 3p3V Regulators (Sheet 3 of 16).....	19
11	TLK10034 EVM Schematic, Power Distribution (Sheet 4 of 16)	20
12	TLK10034 EVM Schematic, Voltage Monitoring (Sheet 5 of 16).....	21
13	TLK10034 EVM Schematic, Device Power, Ground, and Local Decoupling (Sheet 6 of 16)	22
14	TLK10034 EVM Schematic, Global and Control Signals (Sheet 7 of 16).....	23
15	TLK10034 EVM Schematic, USB, MDIO, JTAG, and I ² C Interface (Sheet 8 of 16).....	24
16	TLK10034 EVM Schematic, Clocks (Sheet 9 of 16)	25
17	TLK10034 EVM Schematic, Channel A & B Low Speed Data Signals (Sheet 10 of 16)	26
18	TLK10034 EVM Schematic, Channel C & D Low Speed Data Signals (Sheet 11 of 16).....	27

19	TLK10034 EVM Schematic, Channel A High Speed Data Signals (Sheet 12 of 16).....	28
20	TLK10034 EVM Schematic, Channel B High Speed Data Signals (Sheet 13 of 16).....	29
21	TLK10034 EVM Schematic, Channel C & D High Speed Data Signals (Sheet 14 of 16)	30
22	TLK10034 EVM Schematic, Channel A & B Board to Board Connector (Sheet 15 of 16)	31
23	TLK10034 EVM Schematic, Channel C & D Board to Board Connector (Sheet 16 of 16)	32
24	TLK10034 EVM Motherboard Layout, Top Signal (Layer 1).....	33
25	TLK10034 EVM Motherboard Layout, Internal Ground (Layer 2).....	34
26	TLK10034 EVM Motherboard Layout, Internal Signal (Layer 3)	35
27	TLK10034 EVM Motherboard Layout, Internal Ground (Layers 6,8,11,13,15,17)	36
28	TLK10034 EVM Motherboard Layout, Internal Power (Layer 5)	37
29	TLK10034 EVM Motherboard Layout, Internal Power (Layer 7)	38
30	TLK10034 EVM Motherboard Layout, Internal Signal (Layer 9)	39
31	TLK10034 EVM Motherboard Layout, Internal Signal (Layer 10).....	40
32	TLK10034 EVM Motherboard Layout, Internal Power (Layer 12).....	41
33	TLK10034 EVM Motherboard Layout, Internal Power (Layer 14).....	42
34	TLK10034 EVM Motherboard Layout, Internal Signal (Layer 16).....	43
35	TLK10034 EVM Motherboard Layout, Bottom Signal (Layer 18 Top View)	44
36	TLK10034 EVM SMA Breakout Board Schematic, Sheet 1 Cover Page and Index	46
37	TLK10034 EVM SMA Breakout Board Schematic, Sheet 2 Channel B/C Signals	47
38	TLK10034 EVM SMA Breakout Board Schematic, Sheet 3 Channel A/D Signals	48
39	TLK10034 EVM SMA Breakout Board Schematic, Sheet 4 Common Control Signals	49
40	TLK10034 EVM SMA Breakout Board Layout, Top Signal (Layer 1)	50
41	TLK10034 EVM SMA Breakout Board Layout, Internal Ground (Layer 2).....	51
42	TLK10034 EVM SMA Breakout Board Layout, Internal GND (Layers 3,4,5).....	52
43	TLK10034 EVM SMA Breakout Board Layout, Bottom Signal (Layers 6)	53
44	TLK10034 EVM Voltage Monitor Board Schematic, Sheet 1 Cover Page and Index	55
45	TLK10034 EVM Voltage Monitor Board Schematic, Sheet 2 1V_D1/D2, 2p5V, 3p3V LEDs	56
46	TLK10034 EVM Voltage Monitor Board Schematic, Sheet 3 1p5V, 1p8V, VDDO LEDs	57
47	TLK10034 EVM Voltage Monitor Board Schematic, Sheet 4 VDDA, VDDT, VDDD, DVDD LEDs.....	58
48	TLK10034 EVM Voltage Monitor Board Schematic, Sheet 5 VDDRA_LS/HS LEDs.....	59
49	TLK10034 EVM Voltage Monitor Board Schematic, Sheet 6 VDDRB_LS/HS LEDs.....	60
50	TLK10034 EVM Voltage Monitor Board Schematic, Sheet 7 VDDRC_LS/HS LEDs.....	61
51	TLK10034 EVM Voltage Monitor Board Schematic, Sheet 8 VDDRD_LS/HS LEDs.....	62
52	TLK10034 EVM Voltage Monitor Board Schematic, Sheet 9 2p5V_A/D, 5V LEDs	63
53	TLK10034 EVM Voltage Monitor Board Schematic, Sheet 10 Edge Connector	64
54	TLK10034 EVM Voltage Monitor Board Layout, Top Signal Layer	65
55	TLK10034 EVM Voltage Monitor Board Layout, Internal Ground (Layer 2)	66
56	TLK10034 EVM Voltage Monitor Board Layout, Internal Power (Layer 3).....	67
57	TLK10034 EVM Voltage Monitor Board Layout, Bottom Signal (Layer 4)	68
58	TLK10034 EVM USB Dongle Board Schematic, Sheet 1 Cover Page and Index	70
59	TLK10034 EVM USB Dongle Board Schematic, Sheet 2 Schematics	71
60	TLK10034 EVM USB Dongle Board Layout, Top Signal Layer	72
61	TLK10034 EVM USB Dongle Board Layout, Internal Power (Layer 2).....	73
62	TLK10034 EVM USB Dongle Board Layout, Internal GND (Layer 3)	74
63	TLK10034 EVM USB Dongle Board Layout, Bottom Signal (Layer 4 Top View)	75

List of Tables

1	TLK10034 EVM Motherboard Layer Construction	45
2	TLK10034 EVM SMA Breakout Board Layer Construction	54

3	TLK10034 EVM Voltage Monitor Board Layer Construction.....	69
4	TLK10034 EVM USB Dongle Board Layer Construction.....	76

1 Introduction

The Texas Instruments (TI) TLK10034 SERDES evaluation module (EVM) boards evaluate the functionality and performance of the TLK10034 quad-channel, XAUI/10GBASE-KR transceiver device in a 324-pin PBGA package.

The TLK10034 is a quad-channel, multi-rate transceiver intended for use in high-speed, bidirectional, point-to-point data transmission systems. This device supports three primary modes; a XAUI to 10GBASE-KR transceiver, a general purpose multi-rate 4:1, 2:1, or 1:1 Serializer/De-Serializer (SERDES) link aggregator (8b/10b), and 1G-KX applications.

Operate each channel of the TLK10034 from a single shared-reference clock or independently from one of two separate reference clocks at different frequencies. There are several output clocks allowing support for clocking with an externally-jitter-cleaned clock recovered from the high-speed side. This device is also capable of performing clock-tolerance compensation (CTC) in 10GBASE-KR and 1G-KX modes, allowing for asynchronous clocking.

Other features of the TLK10034 include an integrated latency measurement function, various PRBS, high-, low-, and mixed-CRPAT long/short, CJPAT, and KR pseudo-random test pattern generation and verification for self-test system-level support. Low- and high-speed side loopback modes are provided for self-test and system diagnostic purposes. Several high- and low-speed internal loopback modes are also possible for self-test and system diagnostic purposes.

The TLK10034 has an integrated loss-of-signal (LOS) detection function on both high- and low-speed sides. LOS is asserted in conditions where the input differential voltage swing is less than the LOS assert threshold. The input differential voltage swing must exceed the de-assert threshold to clear the LOS condition.

The low-speed side of the TLK10034 is ideal for interfacing with an FPGA or ASIC located on the same local physical system. The high-speed side is ideal for interfacing with remote systems through an optical fiber, an electrical cable, or a backplane interface. The TLK10034 supports operation with SFP and SFP+ optical modules as well as 10GBASE-KR compatible backplane systems. Both FPGA and Optical interfaces are available in this evaluation system for rapid prototyping and easy development.

Configuration of the TLK10034 on a per-channel basis is available by way of accessing a register space of control bits available through a two-wire access port called the Management Data Input/Output (MDIO) interface as defined in Clause 22 and 45 of the IEEE 802.3 Ethernet specification. ⁽¹⁾ The EVM GUI provides access to all the registers of every device used on any of the TLK10034 boards through a standard USB 1.1 interface. The boards are configurable, if necessary, for accepting or providing MDIO signals from or to an external source by installing and uninstalling certain resistors.

The EVM board is run from one 5-V and two 2p5-V power supplies. All the required voltages are regulated down through on-board LDO regulators which are adjustable to the appropriate minimum, nominal, and maximum values by changing a single resistor value.

Voltage monitor circuits with LEDs are included for all voltage rails for easy debugging and identification of valid power rails through the use of the voltage-monitor board.

All data I/O signals are broken out to connectors for easy and rapid prototyping as well as all control signals are easily controlled through the GUI or shunts on header blocks and dip switches.

⁽¹⁾ The MDIO register map is located within the TLK10034 Quad-Channel XAUI/10GBASE-KR Transceiver data manual.

2 EVM PCB and High-Speed Design Considerations

Use the EVM for the evaluation of device parameters as well as a guide for high-speed board layout. As the frequency of operation increases, take special care to ensure that the highest signal integrity is maintained. This is achieved by controlling the board's impedance to 50- Ω single-ended or 100- Ω differential impedance for both the low- and high-speed differential serial and clock connections. Vias are minimized and, when necessary, are designed to minimize impedance discontinuities along the transmission line. Care was taken to control trace length mismatch (board skew) to less than ± 0.5 mil.

Overall, the board layout is designed and optimized for high-speed operation. Thus, understanding impedance control and transmission line effects are crucial when designing high-speed boards. Some of the advanced features offered by this board include:

- TLK10034 printed-circuit board (PCB) is designed for optimal high-speed signal integrity using Rogers Material for the outer signal layers and FR-4 for the inner layers. All gigabit and clock signals are routed over the Rogers Material for minimal signal loss. The FPGA and SMA Breakout Daughterboards use FR-4 for all layers.
- SMA and header fixtures are easily connected to test equipment.
- All I/O signals are accessible for rapid prototyping.
- On-board capacitors provide ac coupling of differential transmit and receive signals. Zero- Ω resistors placed on the transmit pins allow external loopback tests and only a single ac coupling capacitor on the RX pins is located in between the TX and RX signals. If the TX signals need to be evaluated on their own, the 0- Ω resistors can be replaced with 0.1- μ F capacitors.
- The high-speed signals of channels A and B are routed to SFP+ modules for easy evaluation in systems that implement optical fiber configurations. The high-speed signals of channels C and D are routed to edge launch SMA connectors for easy evaluation in systems that use standard test equipment.
- The low-speed signals of all four channels are routed to Samtec SEAM/SEAF board-to-board connectors allowing for smaller EVM PCB size and additional options for evaluation of these signals. An SMA breakout board is optionally supplied that allows for access to these low-speed signals. SMA cables can be connected from the input to the output signals creating an external loopback situation, or to standard lab test equipment. The pinout is compatible with the TLK10002 EVM FPGA Daughterboard and any variety of custom-interface boards could be created for use with the EVM motherboard.
- The MDIO data signals are routed to the TLK10034 and the bus continues to a 0.10-inch header allowing multiple boards to be daisy chained on a single MDIO Bus.
- This board can operate in standalone mode using an external MDIO data controller and the hardware control pin settings or through the USB Dongle interface. The use of the USB Dongle is recommended and is the preferred mode of operation. All control pins of the TLK10034 device have also been connected to TI's TCA6424 I²C-to-GPIO device. When using the supplied EVM GUI and USB Interface, these control pins must be set to high voltage (logic 1) in hardware and controlled through the GUI interface, allowing the TCA6424 to pull the signals low when needed.

3 TLK10034 EVM Kit Contents

The TLK10034 EVM kit contains the following:

- TLK10034 EVM motherboard
- TLK10034 EVM USB Dongle board
- TLK10034 EVM voltage monitor board
- TLK10034 EVM SMA breakout board (optional)
- TLK10034 EVM User's Guide (this document)
- Banana jack power adapter cables
- USB cable
- CD-ROM containing user interface software

4 Power

The EVM motherboard is powered from one 5-V power supply and two 2p5-V power supplies. The 5-V power supply powers the board's general logic IC's, 1p5-, 1p8-, 2p5- and 3p3-V LDOs as well as the board's LEDs. The 2p5-V analog and 2p5-V digital power supply inputs supply the four 1-V LDOs which source the various 1-V power rails for the core of the TLK10034 device. The power from the LDOs is split into the planes through 1210 zero- Ω resistors that could be replaced with a ferrite bead or inductor should the need arise to filter out any noise that may be present. A series of bulk decoupling capacitors are placed at the entry point of the split planes immediately following the 1210 zero- Ω resistors. Additional local decoupling capacitors are placed near the power pins of the devices connected to the planes in order to source instantaneous switching current and help with noise filtering. Each of the three power supply inputs (5 V, 2p5-V analog, and 2p-V digital) should have a current ability of approximately 2 A, if running in the heaviest power device configurations.

The LDO regulators used on the EVM are TI's TPS74401 and are adjustable using a resistor divider between the output and a feedback pin. Each regulator has been set to provide the appropriate voltage with a slightly higher margin at the source to account for IR drop across the board, since there are no sense lines on these regulators. If more information on the use of these regulators is desired, consult the regulator datasheets found at www.ti.com.

Several power supplies such as VDDRA_LS, VDDRA_HS, VDDRB_LS, VDDRB_HS, VDDRC_LS, VDDRC_HS, VDDRD_LS, VDDRD_HS, and VDDO can be operated off of either 1.5 V or 1.8 V depending upon the specific setup. The EVM allows selection of either of these voltages for use with the previously mentioned TLK10034 supply rails, but only allows one voltage, either 1.5V or 1.8V, to be selected at a time. Selection between 1.5 v and 1.8 V is performed by moving the jumper between the center pin and the respective 1p5- and 1p8-V pins of JMP9.

Refer to the Schematic Sections of this manual for more detailed information on the regulators and power distribution circuitry.

5 Voltage-Monitoring Board and Power-Rail LEDs

The window detection circuits on the voltage-monitoring board drive LEDs, providing quick indication that the voltage is within specification. The voltage-monitoring board draws power from the 5-V plane on the motherboard and a sense line to every power rail on the board is connected to the Samtec MEC1 connector. If the voltage on the sense line is within the minimum or maximum limit for that particular plane, the window detection circuit causes the LED to turn on as an indicator that the plane is properly sourced. If the voltage is outside the minimum or maximum limits the LED does not light, indicating that there is a problem with the power on that rail and the TLK10034 device may not function properly. Several of the power planes on the TLK10034 can be supplied from either 1p5 V or 1p8 V and a separate LED and monitor circuit are supplied for each case to determine whether the board is configured with the intended voltage. The voltage-monitor board is not required for operation of the EVM motherboard and this board is supplied as a tool to be used full time or as a debug device. Hot swapping this board should not cause any damage to either the EVM motherboard or the voltage-monitoring board.

The LEDs are indicators of the status of power on the board being within the acceptable min/max limits given in the datasheet, and not as a precise measurement tool as some LED circuits may turn off at slightly different voltages when approaching the limits due to the manufacturing tolerances and available resistor values.

6 Control and Output Status Signals

All of the external control and status pins on the EVM are consolidated to a single location on the board and broken out onto several header blocks and dip switches. LEDs are added to the LOSA, LOSB, LO SC, LO SD, LS_OK_OUT_A, LS_OK_OUT_B, LS_OK_OUT_C, LS_OK_OUT_D, and PRBS_PASS signals in addition to the headers for scope probes, to allow easy monitoring of the high/low value on the lines. The LED is ON when the line is a logic high, and the LED is OFF when the line is a logic low.

All status pins and external control pins of the TLK10034 can also be monitored or set high/low through the GUI. The preferred method of setting these control pins is through the GUI via the TCA6424 I²C-to-GPIO IC located on the board. If shunts are placed on the header for a particular control pin, or the dip switch setting set low, the signal is physically tied low and software control is not possible. Mixed use of the hardware and software setting of various control pins is discouraged.

The I²C-based software control of the TLK10034 control pins can be disabled by placing a shunt on JMP24 which disables the level shifter attached to the signals by setting the enable pins low or by selecting the *Disable Software Control of Pins* radio button located on the front panel of the GUI. This allows the onboard pullup resistors or shunts to ground on the header pins to set the high/low status of the control pins. If external control is desired and a shunt is placed on JMP24, the *Disable Software Control of Pins* radio button on the GUI front panel must be de-selected, disabling the software portion of the interface.

The TCA6424 device responds to either I²C device address 0x22 or 0x23. When two boards are used and daisy-chained together, the I²C address must be changed on the one of the two boards so that there is individual control of both boards. Flipping the switch on SW5 changes the address from 0x22 to 0x23.

See the TLK10034 data sheet ([SLLSEC0](#)) for a detailed description of the control signals.

7 MDIO

The TLK10034 supports the Management Data Input/Output (MDIO) Interface as defined in Clause 22 and Clause 45 of the IEEE 802.3 Ethernet Specification. The MDIO allows register-based management and control of the serial links. Normal operation of the TLK10034 is possible without the use of this interface, however, most additional features are accessible only through the MDIO interface.

The MDIO management interface consists of a bidirectional data path (MDIO) and a clock reference (MDC). The port address is determined by control pins PRTAD[4:0] as described in the TLK10034 data sheet [SLLSEC0](#).

The top 3 control pins PRTAD[4:2] determine the device port address and are set in hardware on the board. The four individual channels in TLK10034 are classified as 4 different ports. So, any PRTAD[4:2] value has 4 ports per TLK10034. The TLK10034 responds if the 3 MSB's of the PHY address field on MDIO protocol (PA[4:2]) matches PRTAD[4:2]. The LSB of PHY address field (PA[1:0]) determines which channel or port within the TLK10034 to control.

- If PA[1:0] = 2'b00, TLK10034's channel A responds.
- If PA[1:0] = 2'b01, TLK10034's channel B responds.
- If PA[1:0] = 2'b10, TLK10034's channel C responds.
- If PA[1:0] = 2'b11, TLK10034's channel D responds.

Write transactions that address an invalid register or read-only registers are ignored. Read transactions of invalid registers return a 0.

The TLK10034 requires either 1.5- or 1.8-V I/O levels on the MDIO/MDC signals. Therefore, an on-board bidirectional level shifter has been provided, level shifting the 3.3-V MDIO and MDC signals to the appropriate 1.5/1.8V levels. If a different MDIO controller is used that already has 1.5- or 1.8-V signal levels, resistors R184, R185, R170, and R171 must be removed, thus disconnecting the level shifter. Resistors R161 and R165 can be installed which connect the TLK10034 MDIO and MDC signal pins directly to the pins of JMP29.

The USB Dongle implementing TI's TUSB3210 microcontroller is the preferred method of controlling the TLK10034 register stack and is the **only** way to interface the GUI with the board. When the USB Dongle is connected to the EVM board through the Samtec MEC1 connector, the MDIO signals are at 3.3-V levels because the TUSB3210 is a 3.3-V device with open drain architecture. The EVM board has TI's TXS0108EPWR bidirectional level shifter to convert the MDIO signals to the 1.5/8V levels required by the TLK10034. Ensure that a shunt is placed on the 3.3-V and MDIO_LS pins of JMP30 on the EVM board to ensure that the appropriate 3.3-V voltage is used on the level shifter and pull-up resistors. The 2.5-V voltage option is supplied for TI use only with a legacy MDIO Controller.

MDIO signals can be routed to either of the low-speed board-to-board connectors for use with the TLK10002 EVM FPGA Daughterboard or other interface boards that may require MDIO communication on the same MDIO bus as the TLK10034. This feature is not currently supported but is planned in a future revision. Control over the relays used to route the MDIO bus without creating stub branches is done using switch SW5, or through the TCA6424 I²C interface and GUI.

The MDIO PRTAD[4:2] is defaulted to 3b'000. If this value is changed in hardware, it must also be changed in the GUI so that proper MDIO communication is possible.

8 JTAG

The EVM also provides a separate connector to support the full five-pin JTAG interface of the TLK10034 with onboard level shifters to be compatible with most standard JTAG control interfaces used for manufacturing tests. The 3.3-V (header) side of the level shifter is connected to the header and the 1.5/8V side of the level shifter is connected to the TLK10034. If the level shifter is not needed, providing an external voltage of the appropriate signal level between pins 2 and 3 of JMP33 allows the signals to pass to the TLK10034 correctly.

9 Reset

The EVM comes configured for manual reset operations using the pushbutton reset switch (SW1). When SW1 is pressed, the TLK10034 device RESET pin (RST_N) goes LOW and the entire TLK10034 device is reinitialized. A TI TPS3125J18 ultra-low voltage processor supervisory circuit controls the reset line. During power-on, $\overline{\text{RESET}}$ pin of U12 is asserted when the supply voltage becomes higher than 0.75 V. Thereafter, the supply voltage supervisor monitors the voltage and keeps $\overline{\text{RESET}}$ output active as long as the voltage remains below the threshold voltage (V_{IT}). An internal timer delays the return of the output to the inactive state (high) to ensure proper system reset. The delay time, $t_d = 180$ ms, starts after the voltage has risen above the threshold voltage (V_{IT}).

A manual reset input to the supervisory circuit, $\overline{\text{MR}}$, accepts the input from the pushbutton switch SW1. A low level at $\overline{\text{MR}}$ causes $\overline{\text{RESET}}$ to become active, thus resetting the TLK10034 device whenever the pushbutton RESET is pressed. By placing a jumper on JMP23, the manual reset ($\overline{\text{MR}}$) is tied hard to ground causing the TLK10034 to be held in a constant state of reset without the need to continually hold the Reset Pushbutton, SW1. The supervisory circuit releases the reset line to a HIGH 180 ms (t_d) from the time the $\overline{\text{MR}}$ line becomes greater than the threshold voltage (V_{IT}).

NOTE: Issue all RESET commands through the GUI via the TCA6424 I²C-to-GPIO device connected to the signals to keep the GUI setting and the device settings synchronized during evaluation. When the software **Main Board Reset** buttons are pressed, the GUI adjusts its memory settings of the various registers to match the new values the devices reflect after the hardware RESET is performed. If the buttons are pressed on the board, the GUI does not reflect the devices' true status and may result in erroneous results during testing because the device is not configured according to the GUI's displayed results.

Depending upon the power down and or GUI-termination sequence followed, the USB device may need to be RESET to allow re-enumeration to occur in future tests. When the board is powered on and the USB connection is enumerated, the USB online LED (D4) lights on the USB Dongle board. If this LED fails to light, a PC-related issue may exist, and the PC must be restarted. The LED lights once the PC error is fixed. If the USB connection is improperly disconnected or terminated, the USB SUSPEND light, D3, lights and is an indication that the USB connection is not properly established. A reset pushbutton is located on the USB Dongle board and pressing this device resets the TUSB3210 microcontroller as well as momentarily disconnecting the USB device from the PC's USB bus, causing the PC to re-enumerate the device after the reset is complete.

10 Test and Setup Configurations

Look for more detailed test setups and descriptions in future revisions of this document.

The EVM has an SPF+ Optical Module Cage attached directly to the channel A and B's high-speed signals through approximately 3 inches of trace over Rogers Low-Dielectric material. Channel C and D's high-speed signals are attached to Edge Launch SMA connectors with 0.1- μ F ac coupling capacitors on the RX lines, and 0- Ω resistors on the TX lines facilitating an external loopback configuration with only a single set of capacitors in line. The capacitors or resistors must be carefully reworked as necessary to facilitate the test needs during evaluation. Placing two 0.1- μ F ac coupling capacitors can result in lower performance and greater numbers of bit errors.

All low-speed signals on the input signals have 0.1- μ F ac coupling capacitors and are routed to a Samtec SEAF board-to-board connector that mates with either an SMA breakout board for use in parametric and laboratory testing, or a Spartan-6 FPGA board for system-level evaluation. The output signals are connected to 0- Ω resistors allowing them to be connected to the ac coupled input signals. These 0- Ω resistors can easily be re-worked with 0.1- μ F capacitors for ac-coupled applications.

The MDIO bus that is connected to the TLK10034 is also routed to the SEAF board-to-board connector and can be used to interface with either the FPGA or an external system board via the post level shifter MDIO signal header on the SMA breakout board.

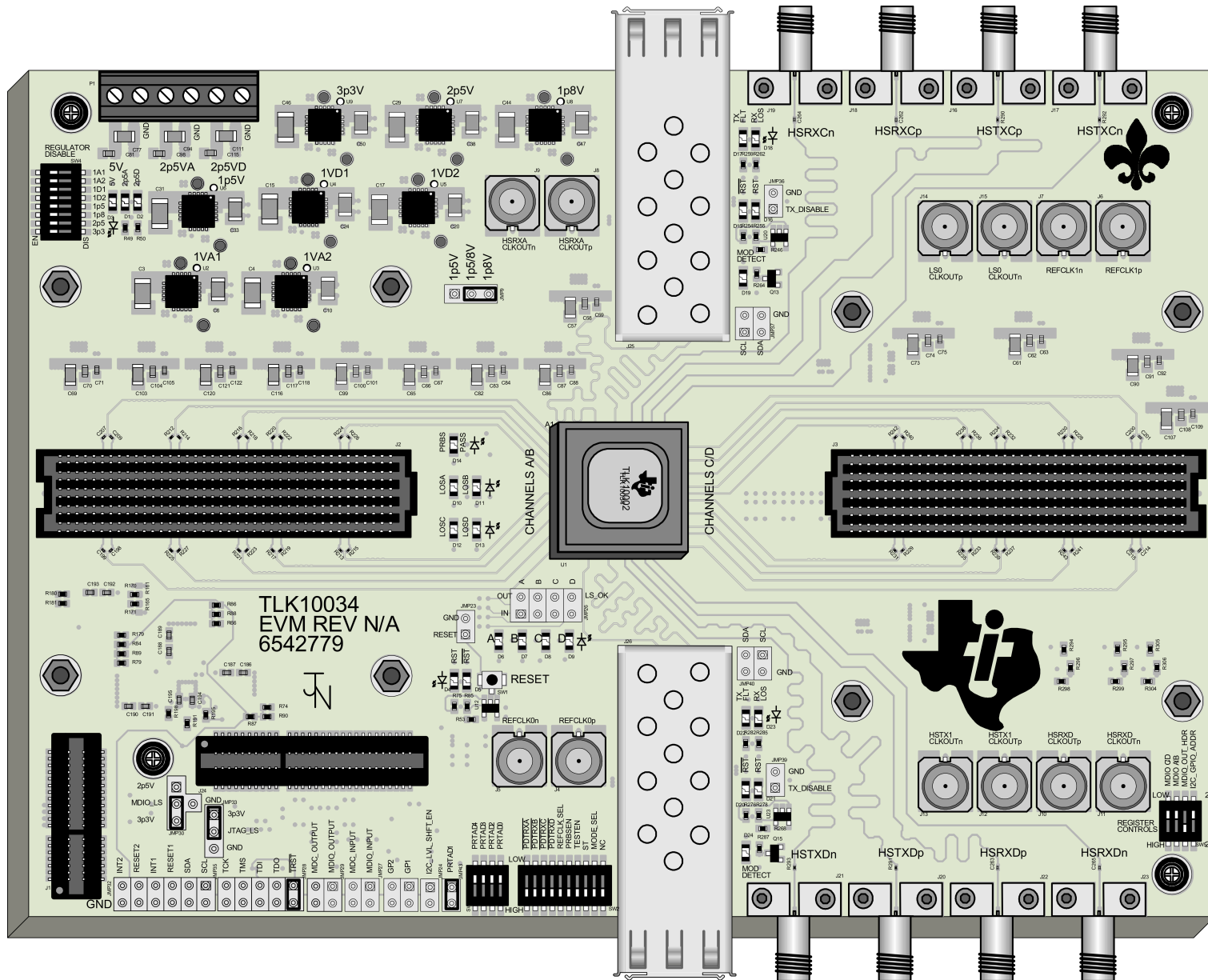

Figure 1. TLK10034 EVM Motherboard

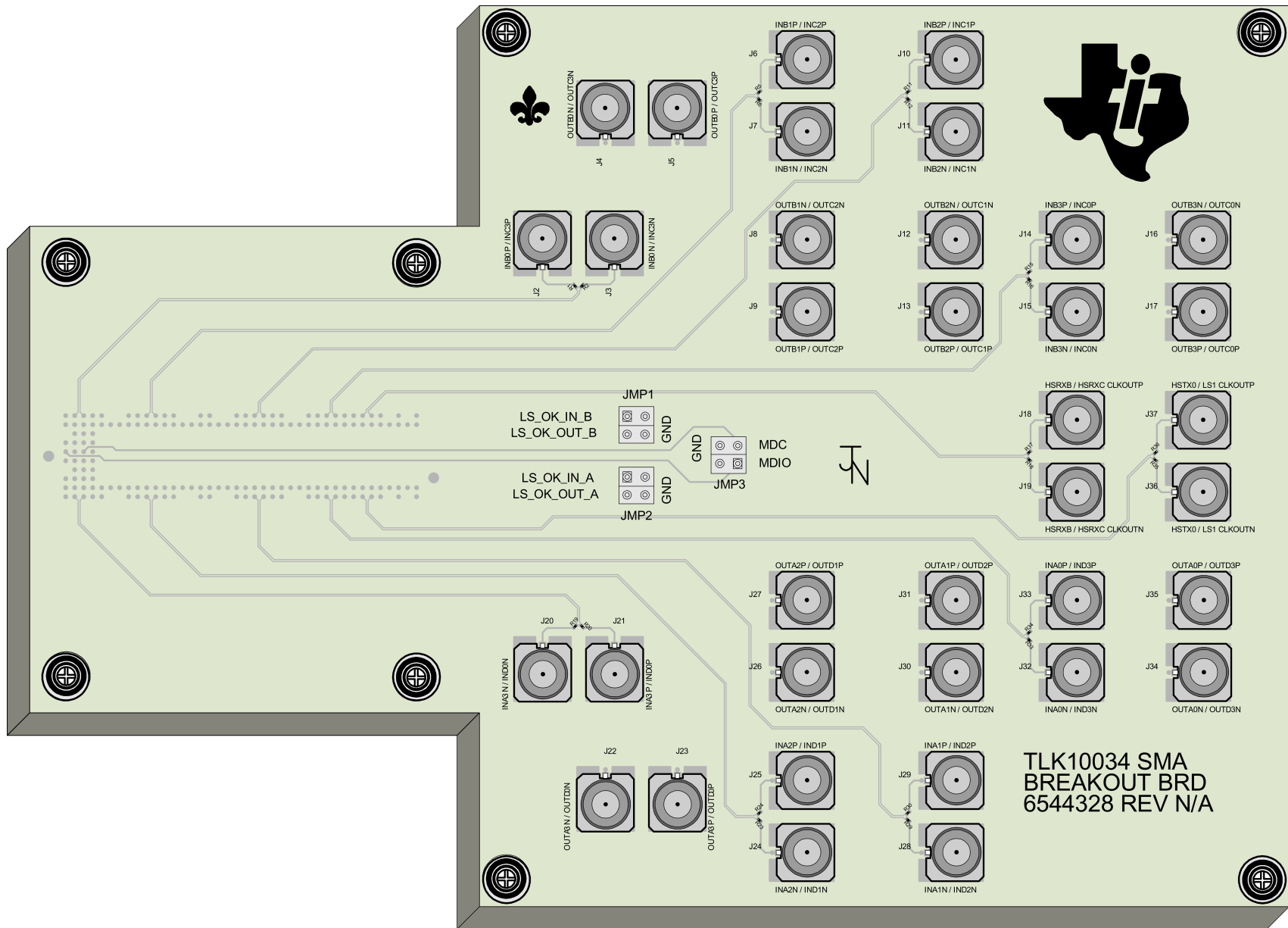

Figure 2. TLK10034 EVM SMA Breakout Board

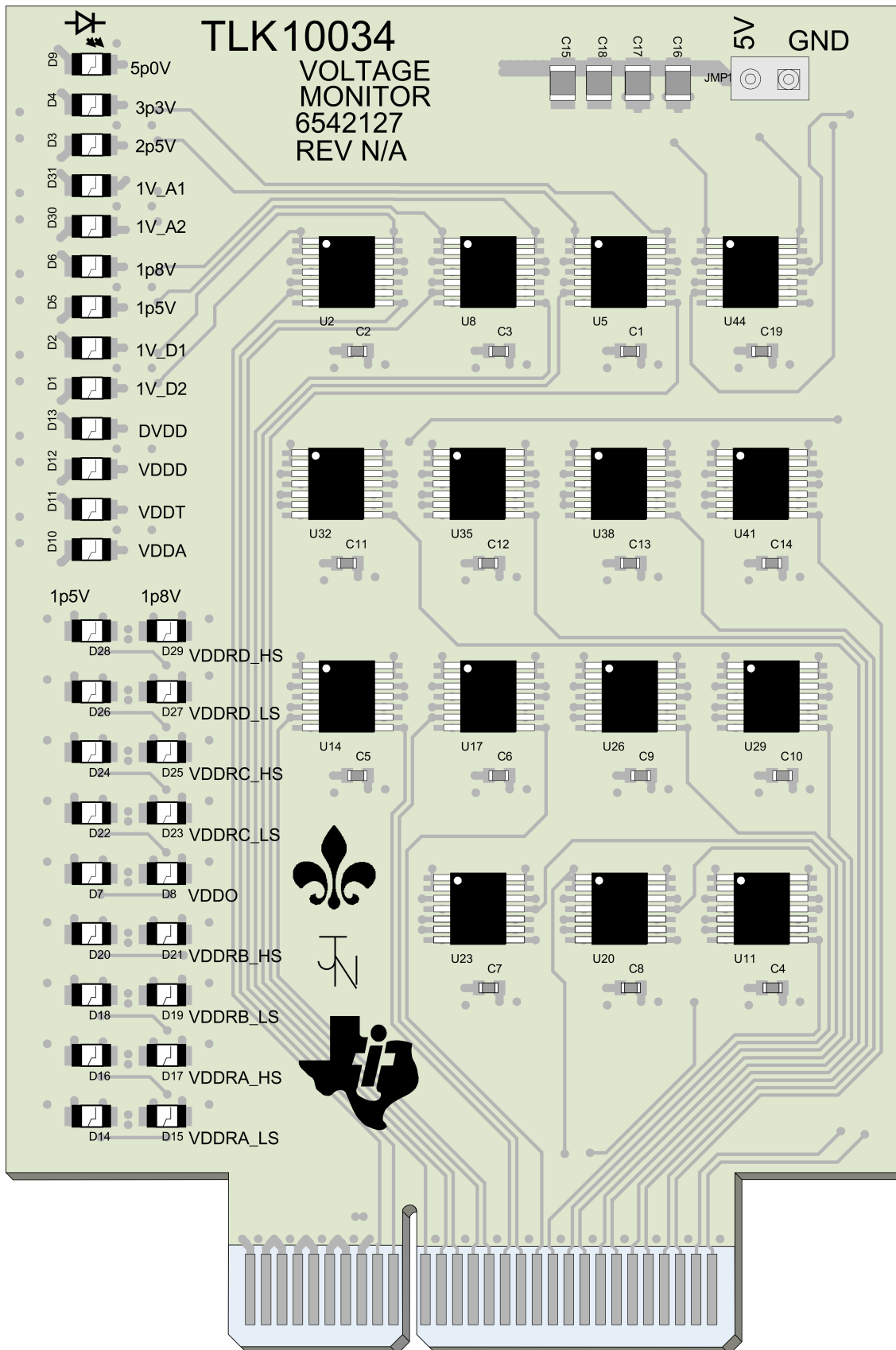

Figure 3. TLK10034 EVM Voltage Monitor Board

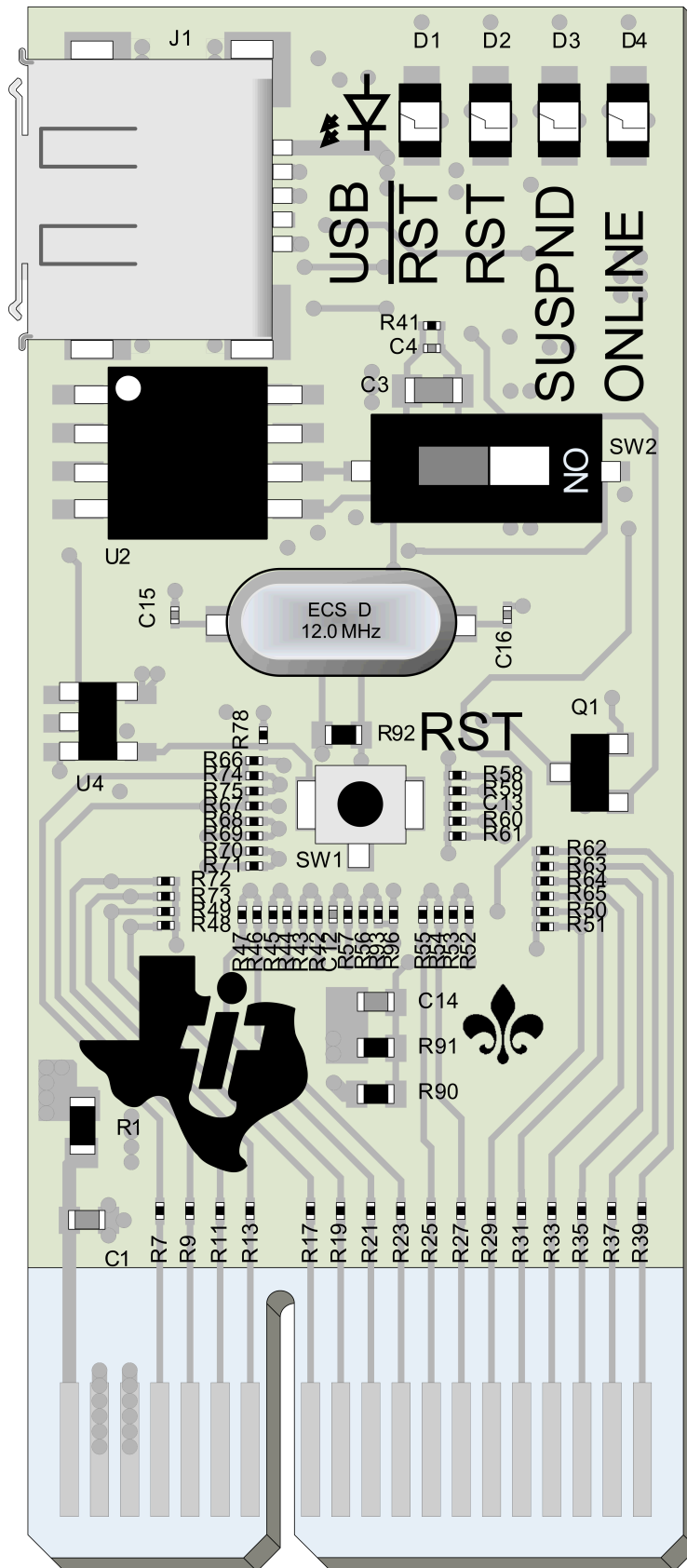

Figure 4. TLK10034 EVM USB Dongle Board

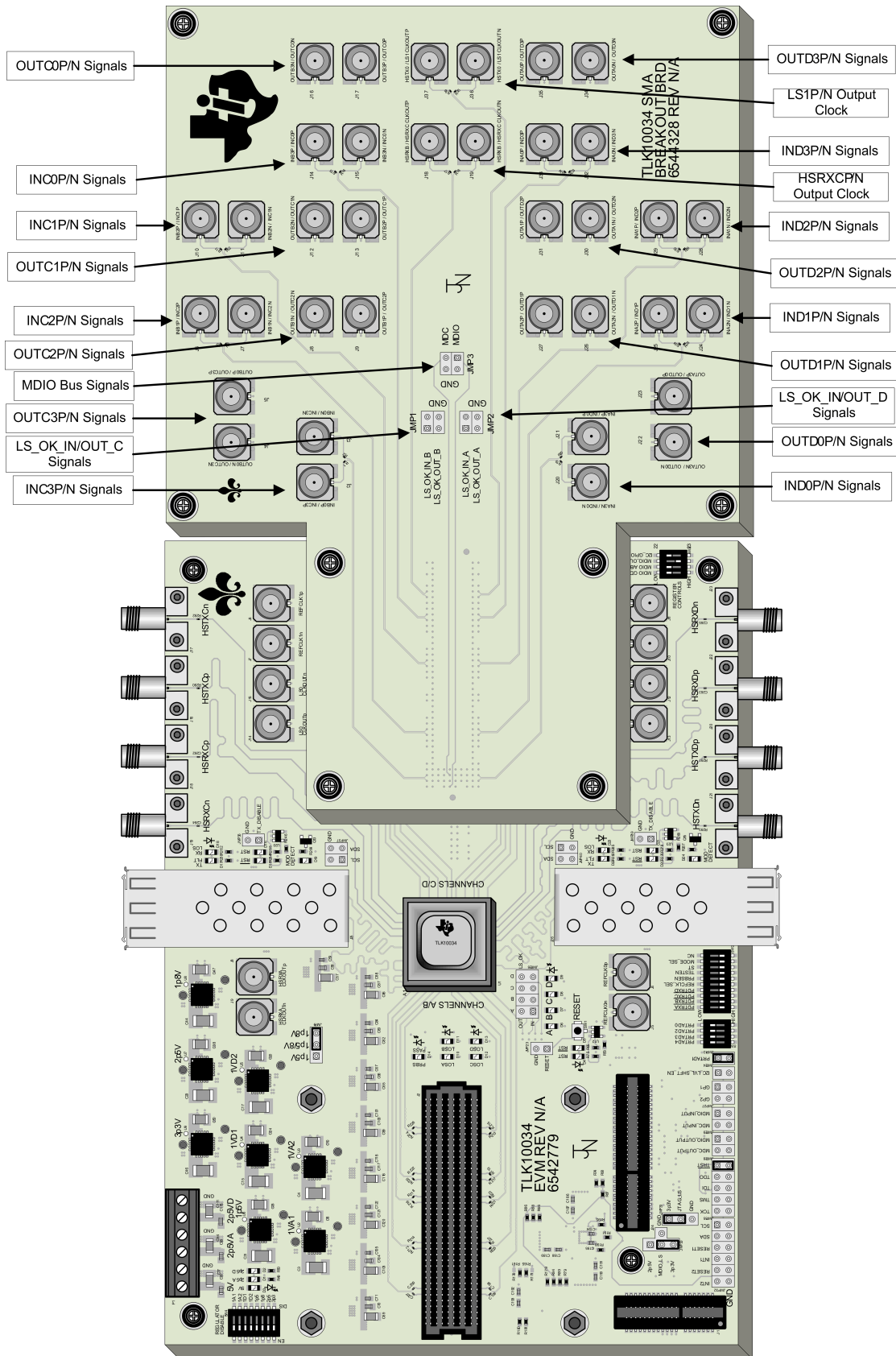

Figure 5. TLK10034 EVM Motherboard and SMA Breakout Board for Channels C/D

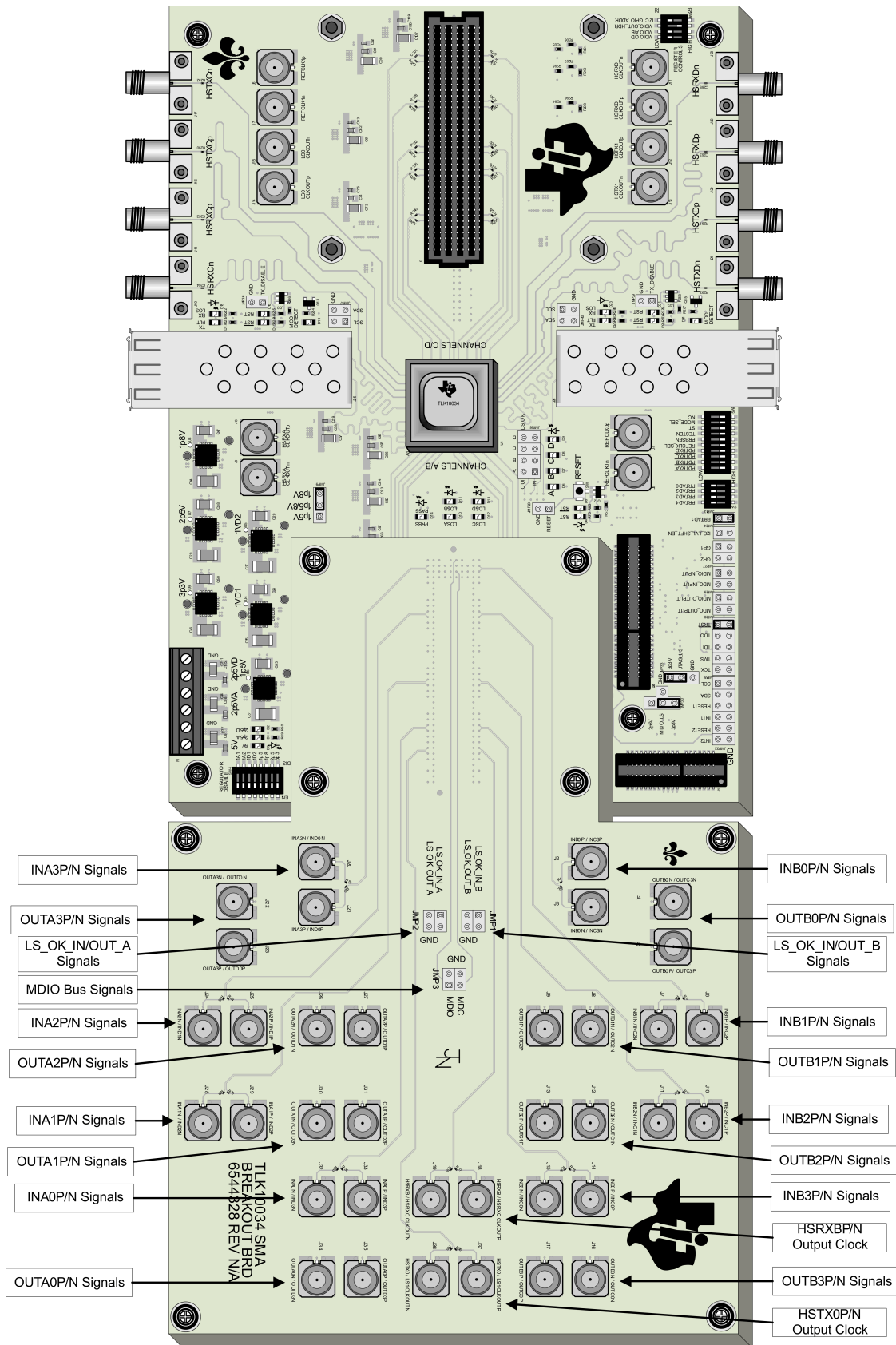

Figure 6. TLK10034 EVM Motherboard and SMA Breakout Board for Channels A/B

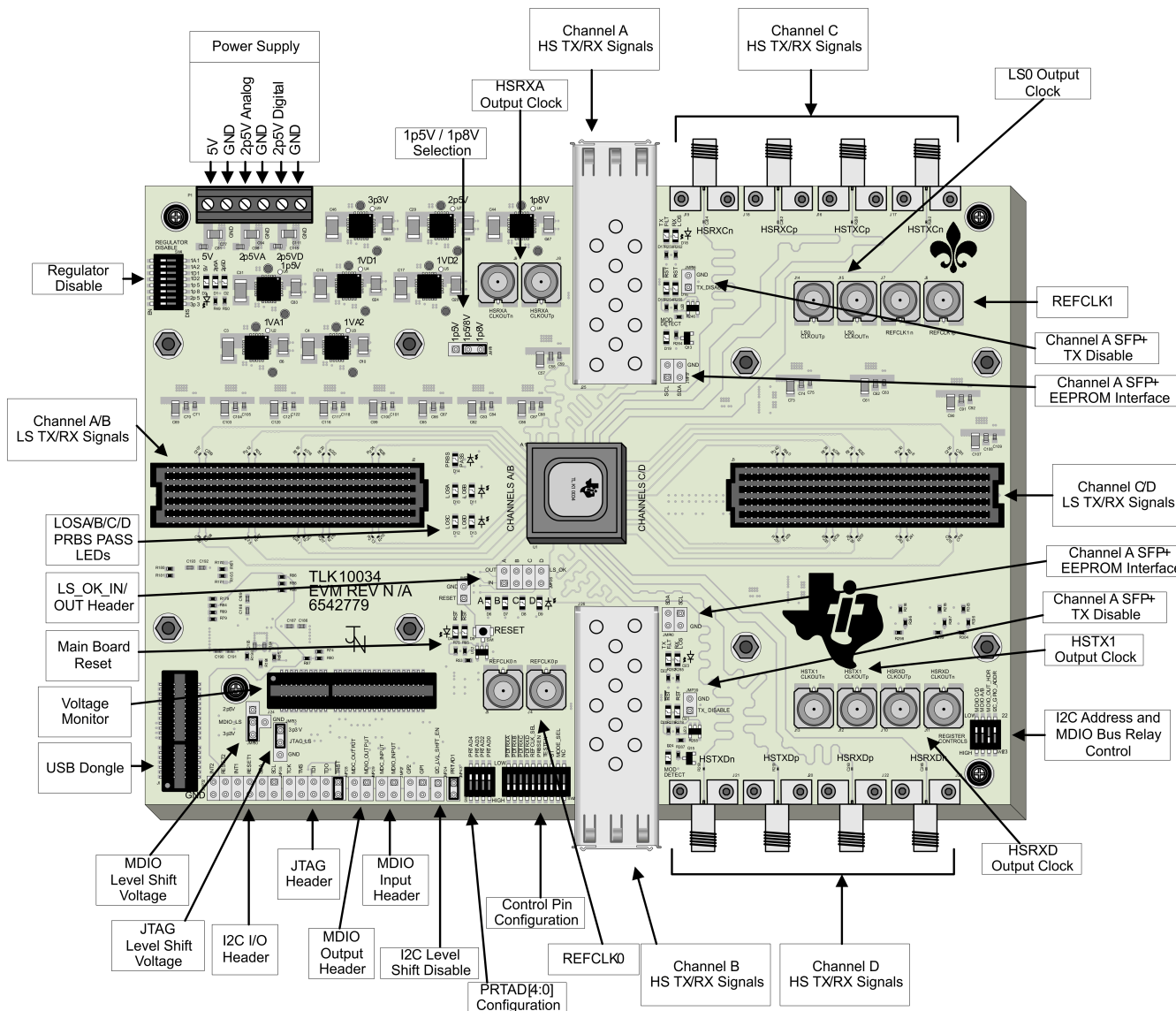

Figure 7. TLK10034 EVM Motherboard Features

11 TLK10034 EVM Motherboard Schematics

NOTES:

1. PLACE NET NAMES ON ALL JUMPERS AND HEADERS.
2. PLACE ALL PARTS OTHER THAN SMP CONNECTORS ON A 0 OR 90 DEGREE ORIENTATION.
3. SERIAL DATA SHOULD BE ROUTED AS SINGLE-ENDED 50 OHM TRANSMISSION LINES ON OUTSIDE LAYERS. ROUTING DISTANCE SHOULD BE 3 INCHES OR LESS.
4. USE ROGERS MATERIAL FOR OUTSIDE LAYERS AND FR4-370 MATERIAL FOR INSIDE LAYERS.
5. SERIAL AND REFCLK NETS MUST MATCH WITHIN +/- 0.5 MILS
6. MATCH DIFFERENTIAL TRACE WIDTHS OF SERIAL AND REFCLK LINES WITH SMP/SMA PADS.
7. PLACE TI LOGO IN TOP SIDE METAL

SCHEMATIC SHEET INDEX:

SHEET 01: TLK10034 EVM MOTHER BOARD COVER SHEET AND NOTES
 SHEET 02: 1P0V ANALOG REGULATORS
 SHEET 03: 1P5V, 1P8V, 2P5V, AND 3P3V REGULATORS
 SHEET 04: POWER DISTRIBUTION
 SHEET 05: VOLTAGE MONITORING
 SHEET 06: DEVICE POWER, GROUND, AND LOCAL DECOUPLING
 SHEET 07: GLOBAL AND CONTROL SIGNALS
 SHEET 08: USB, MDIO, JTAG, AND I2C INTERFACE
 SHEET 09: CLOCKS
 SHEET 10: CHANNEL A & B LOW SPEED DATA SIGNALS
 SHEET 11: CHANNEL C & D LOW SPEED DATA SIGNALS
 SHEET 12: CHANNEL A HIGH SPEED DATA SIGNALS
 SHEET 13: CHANNEL B HIGH SPEED DATA SIGNALS
 SHEET 14: CHANNEL C & D HIGH SPEED DATA SIGNALS
 SHEET 15: CHANNEL A & B BOARD TO BOARD CONNECTOR
 SHEET 16: CHANNEL C & D BOARD TO BOARD CONNECTOR



TEXAS INSTRUMENTS

SCHEMATIC TITLE
TLK10034 EVM MOTHER BOARD

PAGE TITLE
COVER PAGE AND NOTES

SIZE	DOCUMENT NUMBER	REV	SHEET
B	6542779	NA	1 of 16

Figure 8. TLK10034 EVM Schematic, Cover Page and Index (Sheet 1 of 16)

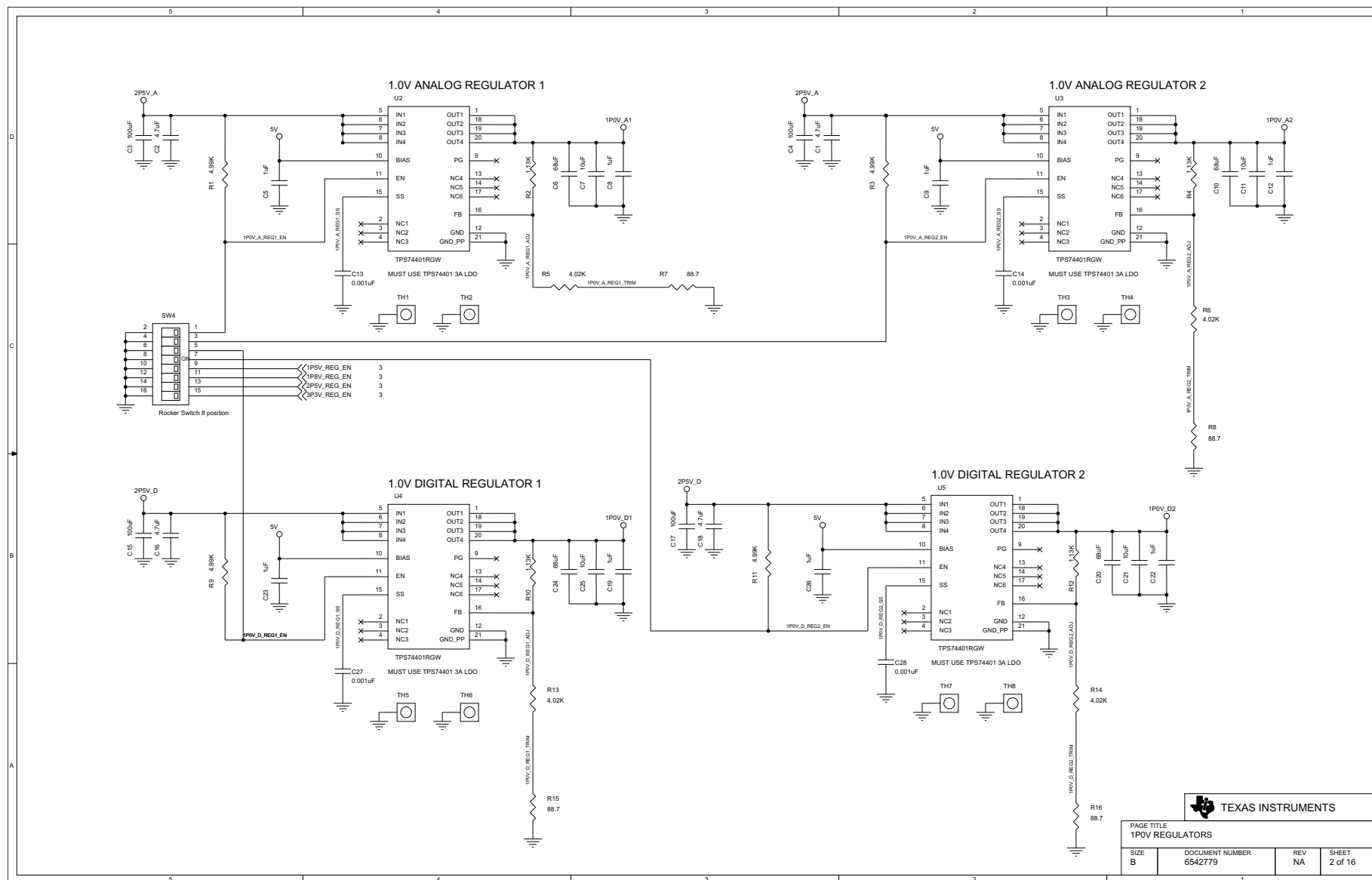

Figure 9. TLK10034 EVM Schematic, 1p0V Analog Regulators (Sheet 2 of 16)

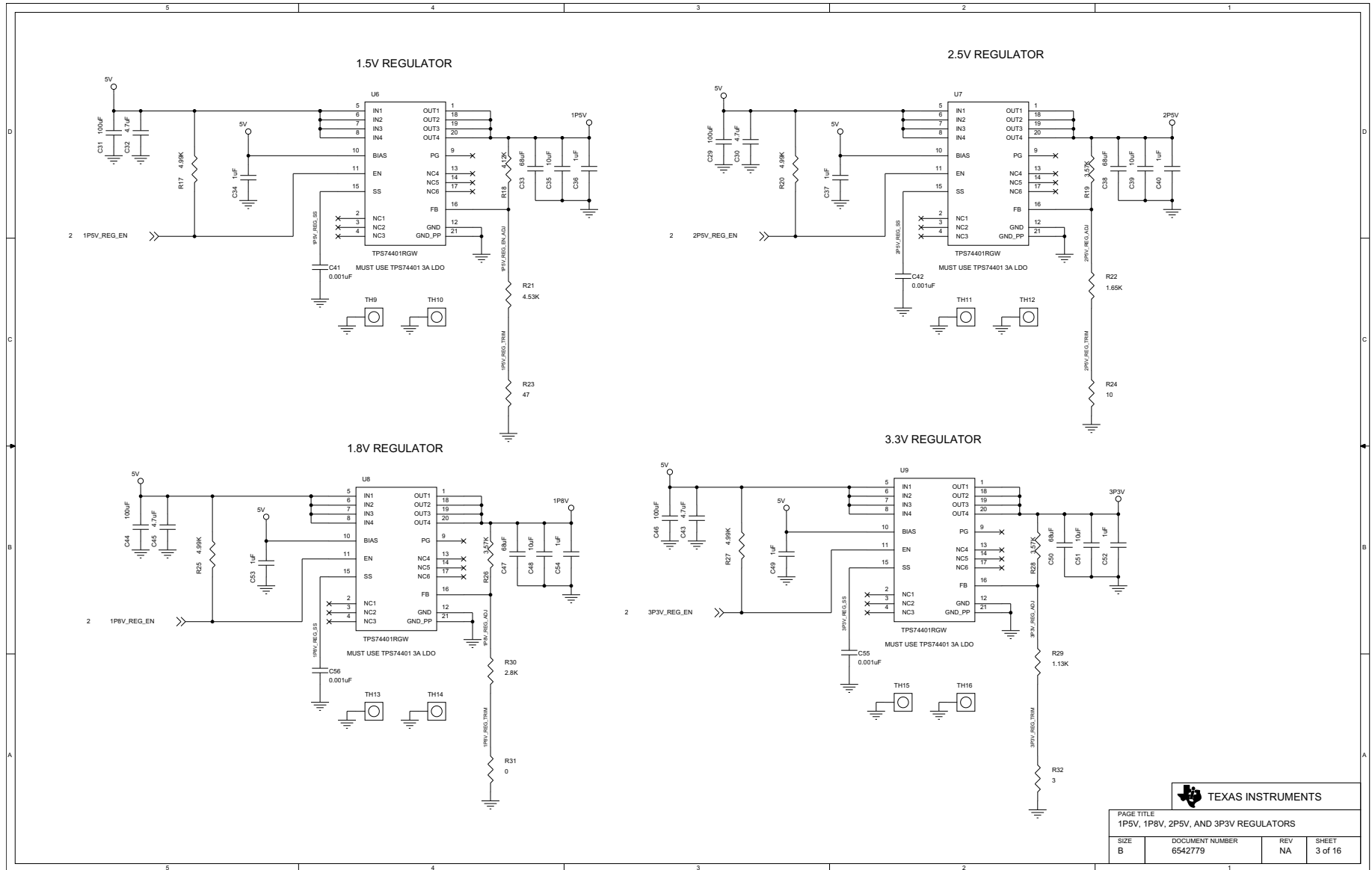

Figure 10. TLK10034 EVM Schematic, 1p5V, 1p8V, 2p5V, And 3p3V Regulators (Sheet 3 of 16)

PAGE TITLE			
1P5V, 1P8V, 2P5V, AND 3P3V REGULATORS			
SIZE		DOCUMENT NUMBER	
B		6542779	
REV		SHEET	
NA		3 of 16	

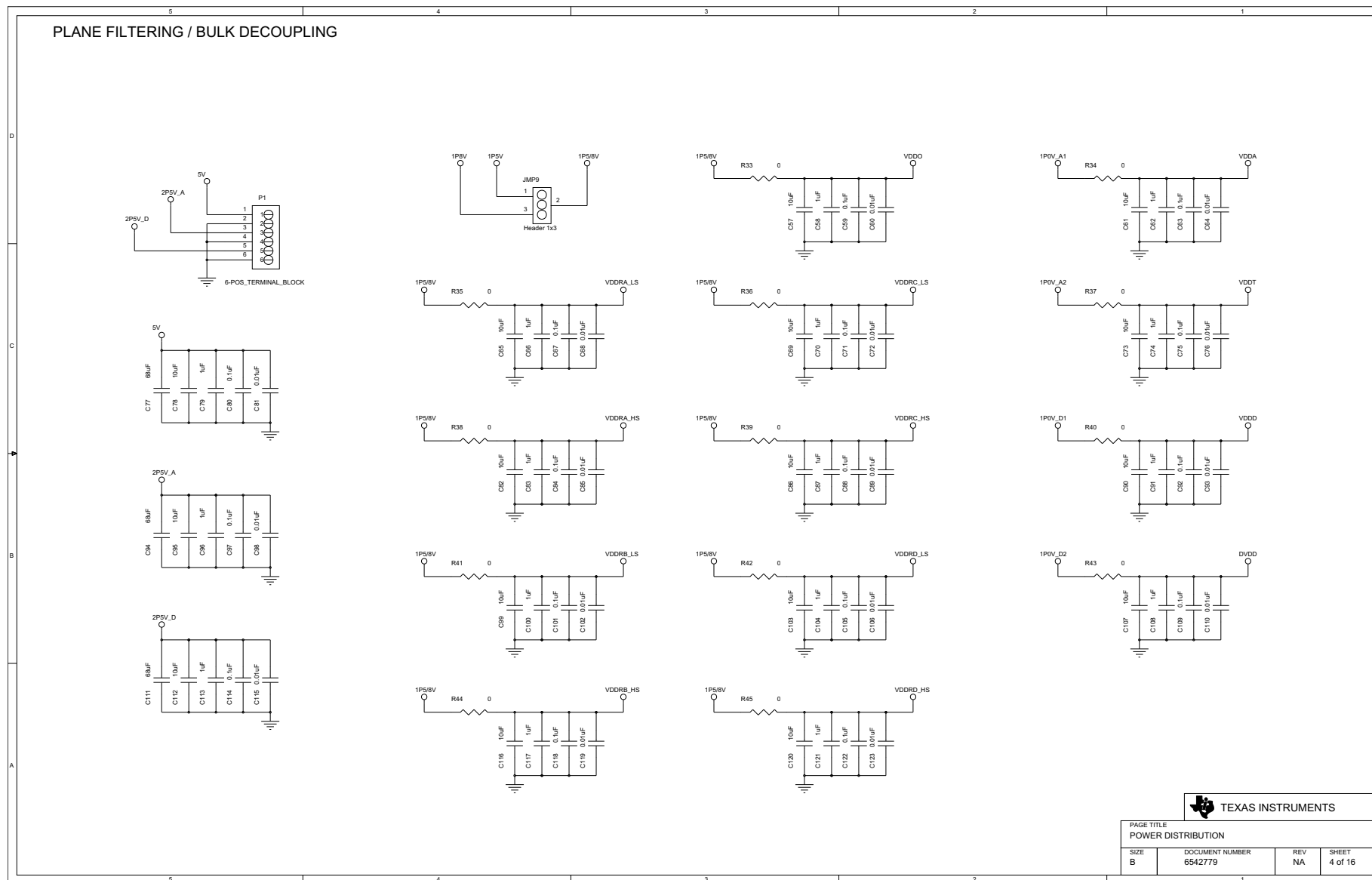

Figure 11. TLK10034 EVM Schematic, Power Distribution (Sheet 4 of 16)

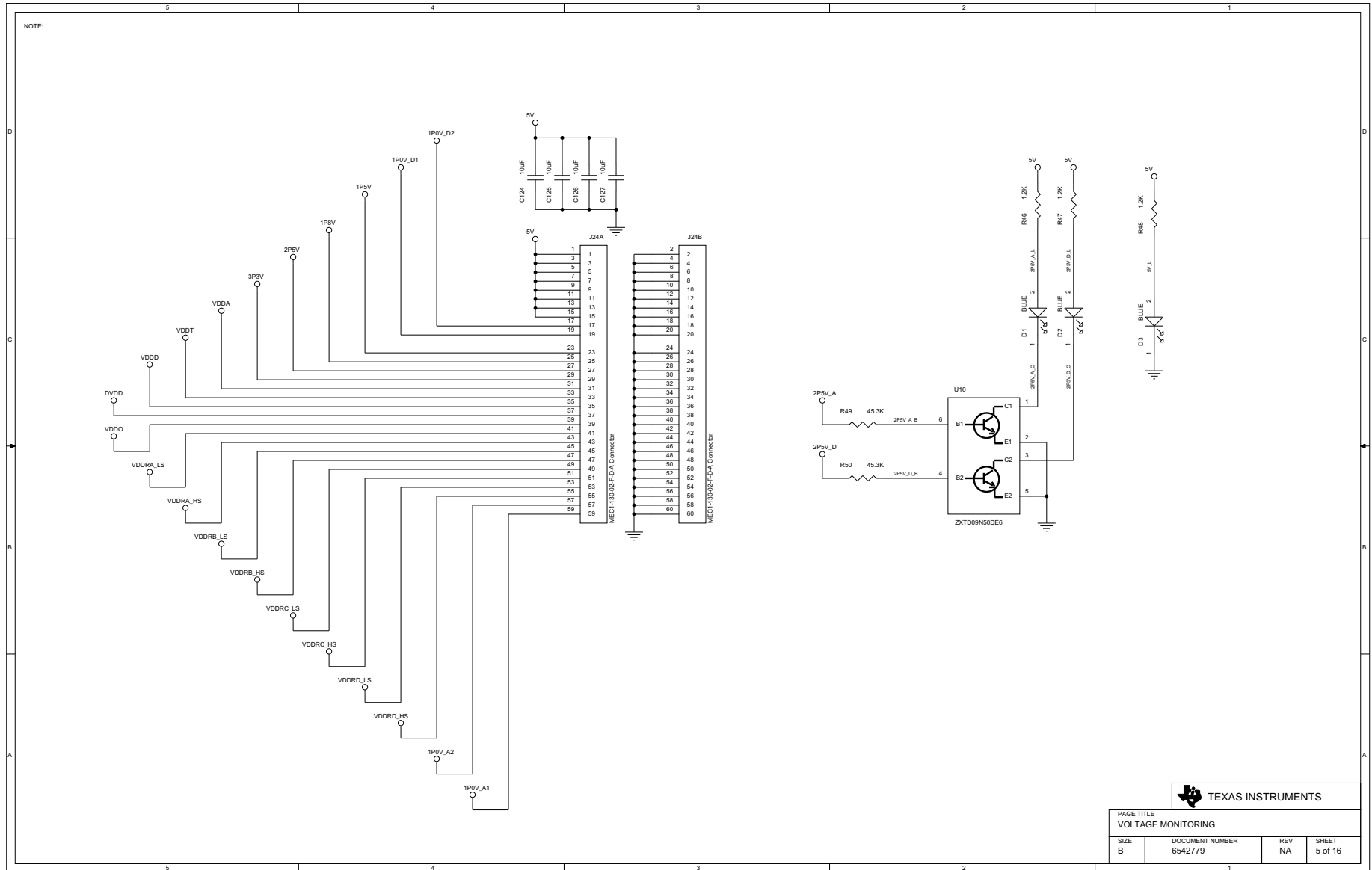

Figure 12. TLK10034 EVM Schematic, Voltage Monitoring (Sheet 5 of 16)

PAGE TITLE VOLTAGE MONITORING			
SIZE B	DOCUMENT NUMBER 6542779	REV NA	SHEET 5 of 16

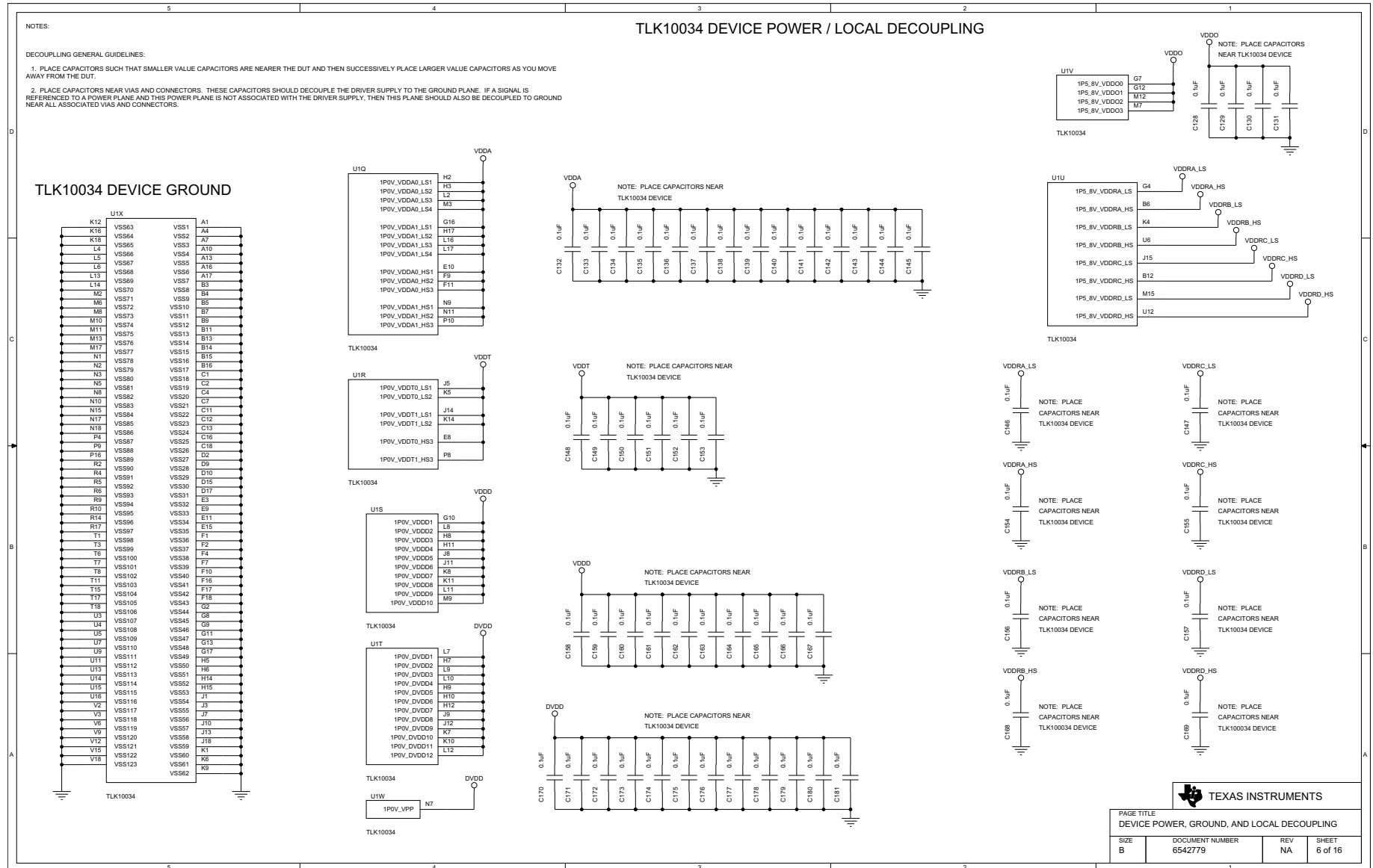
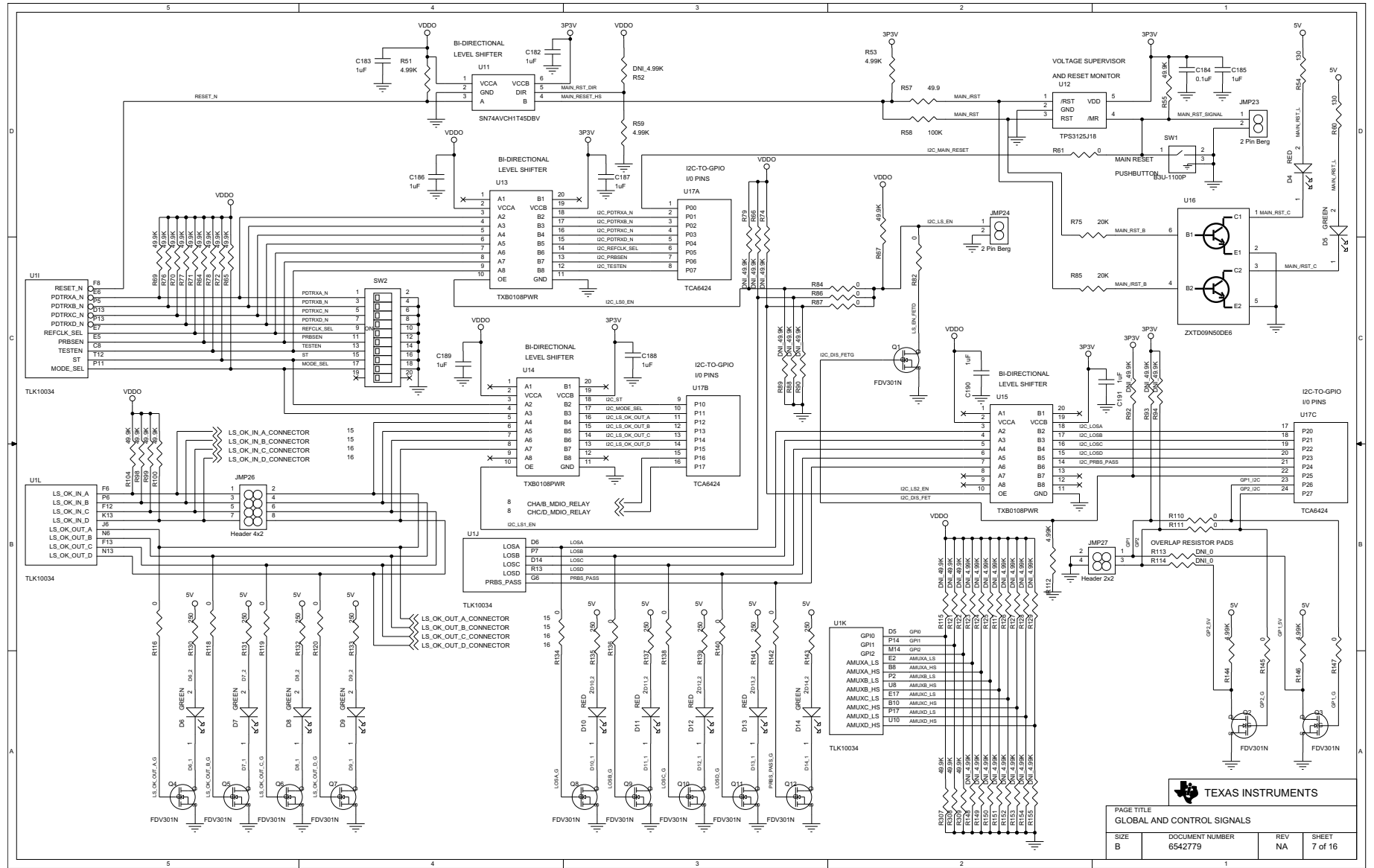

Figure 13. TLK10034 EVM Schematic, Device Power, Ground, and Local Decoupling (Sheet 6 of 16)



TEXAS INSTRUMENTS			
PAGE TITLE GLOBAL AND CONTROL SIGNALS			
SIZE B	DOCUMENT NUMBER 6542779	REV NA	SHEET 7 of 16

Figure 14. TLK10034 EVM Schematic, Global and Control Signals (Sheet 7 of 16)

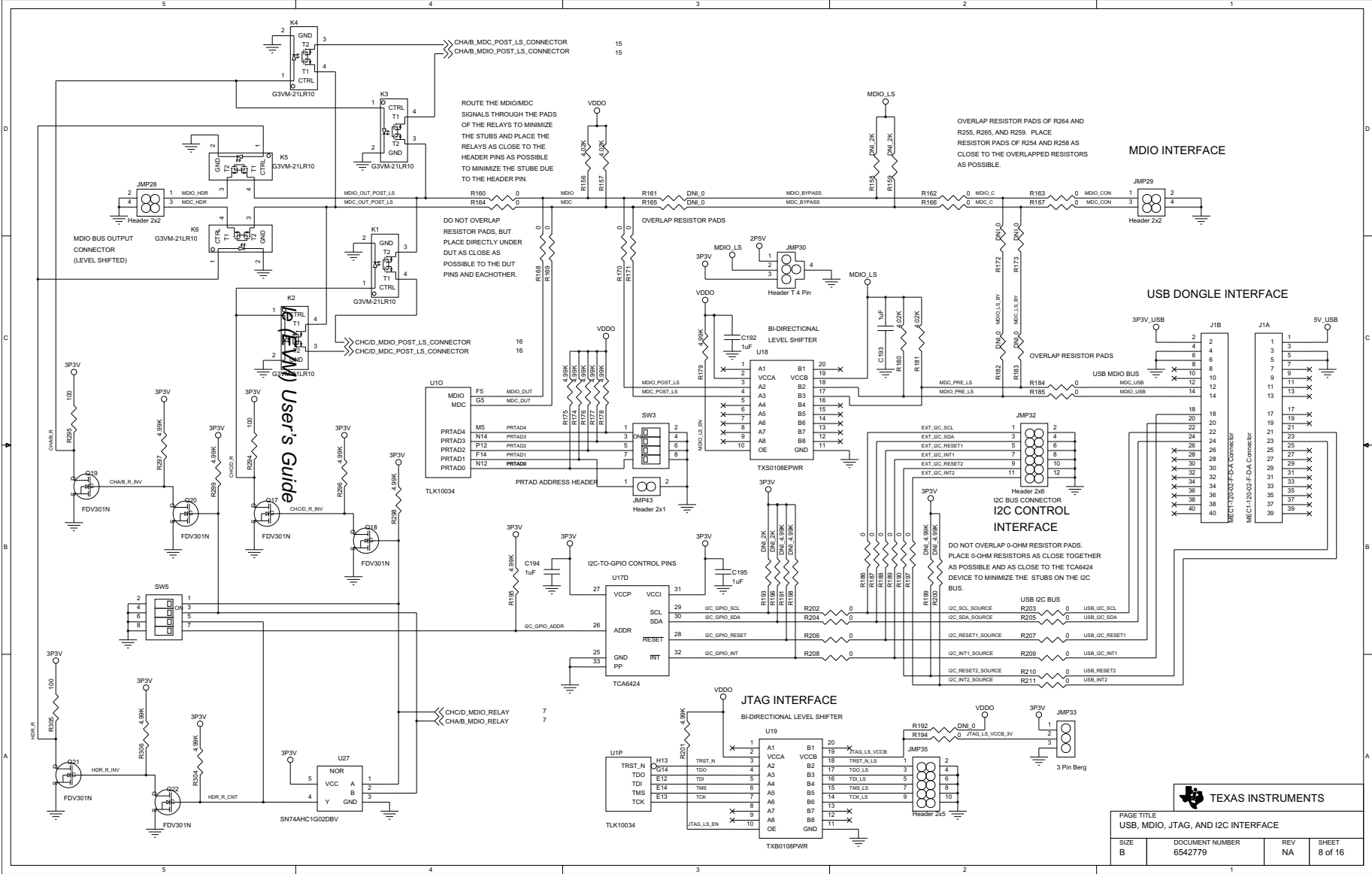

Figure 15. TLK10034 EVM Schematic, USB, MDIO, JTAG, and I2C Interface (Sheet 8 of 16)

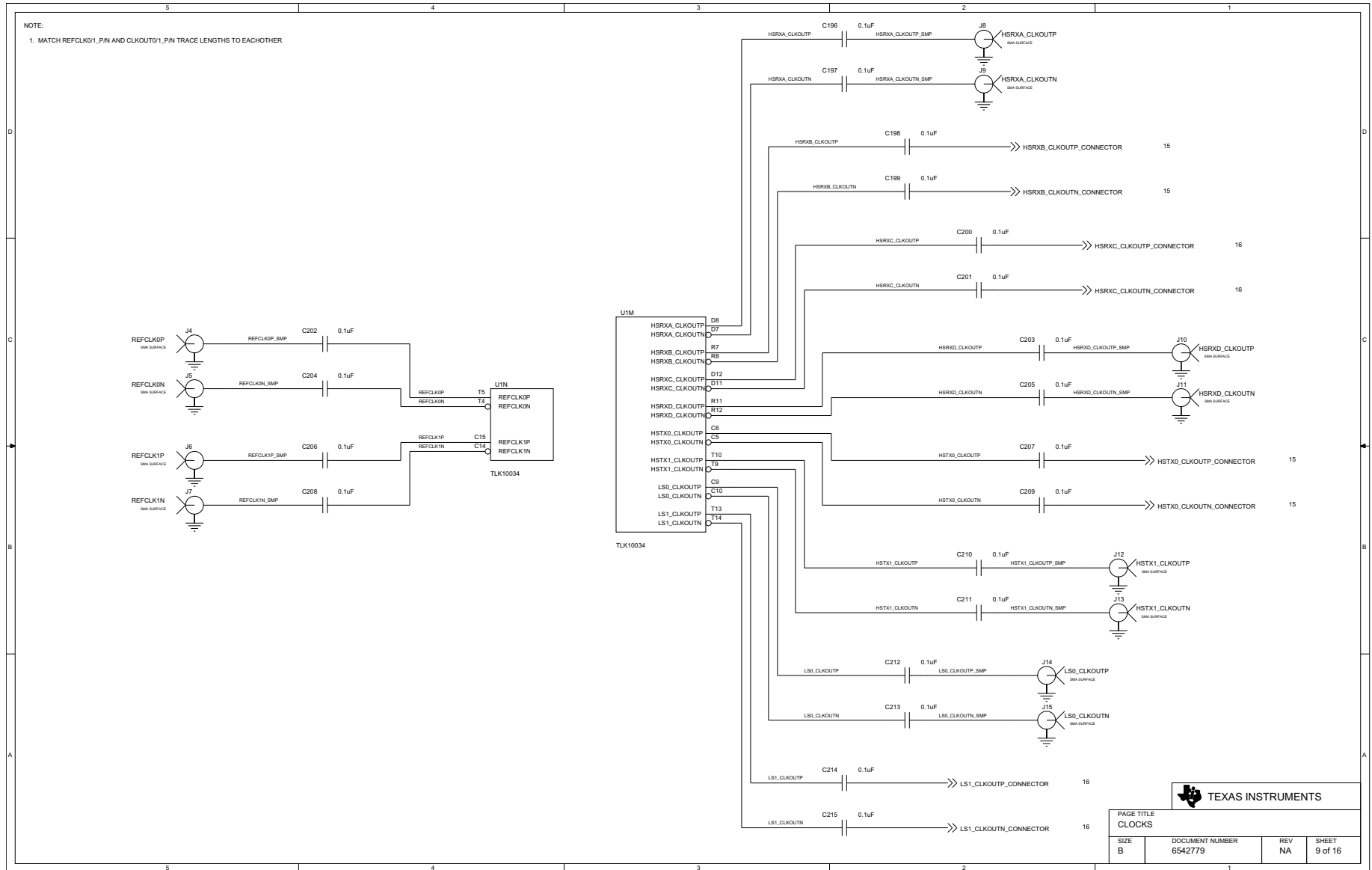

Figure 16. TLK10034 EVM Schematic, Clocks (Sheet 9 of 16)

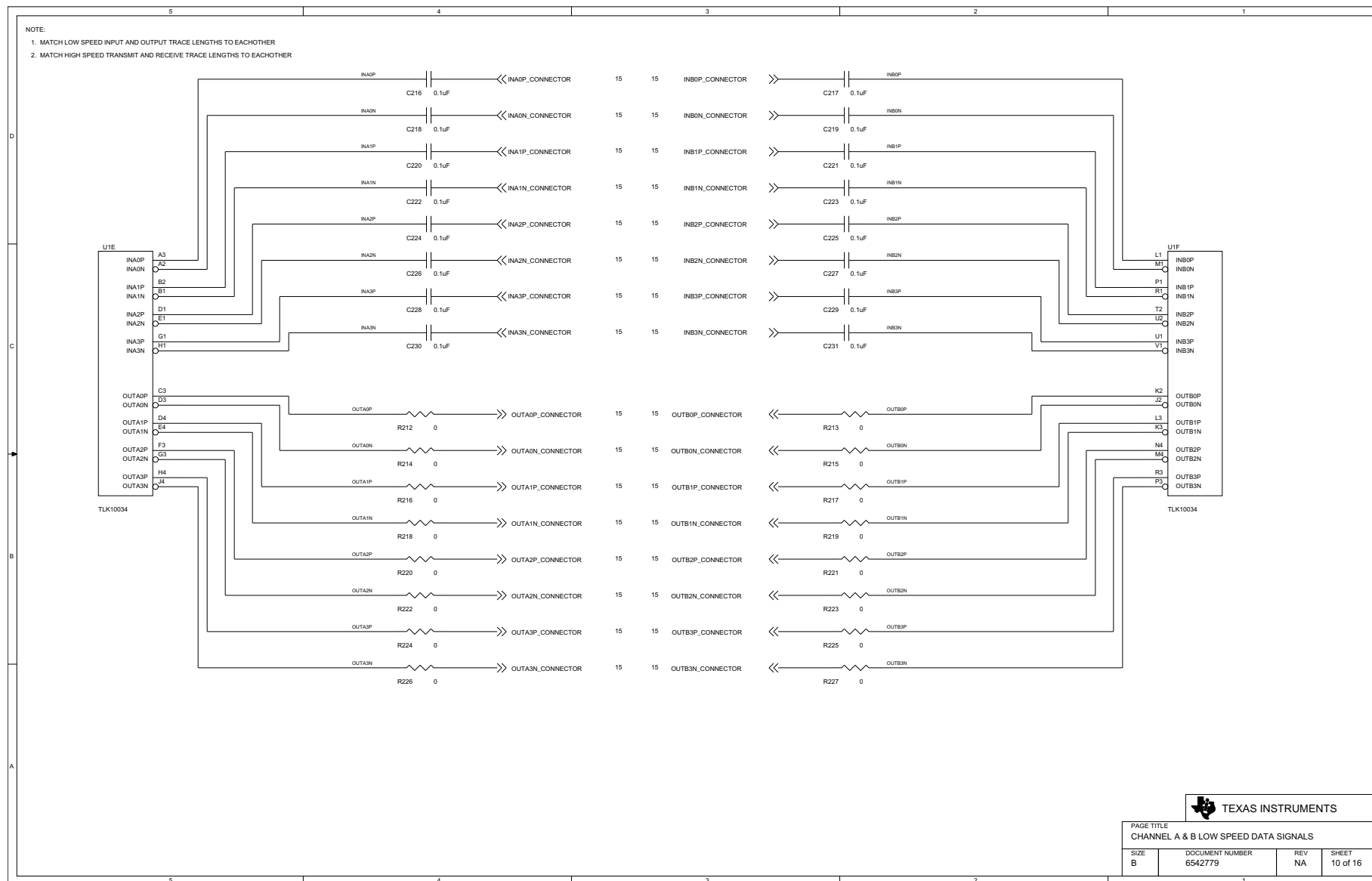

Figure 17. TLK10034 EVM Schematic, Channel A & B Low Speed Data Signals (Sheet 10 of 16)

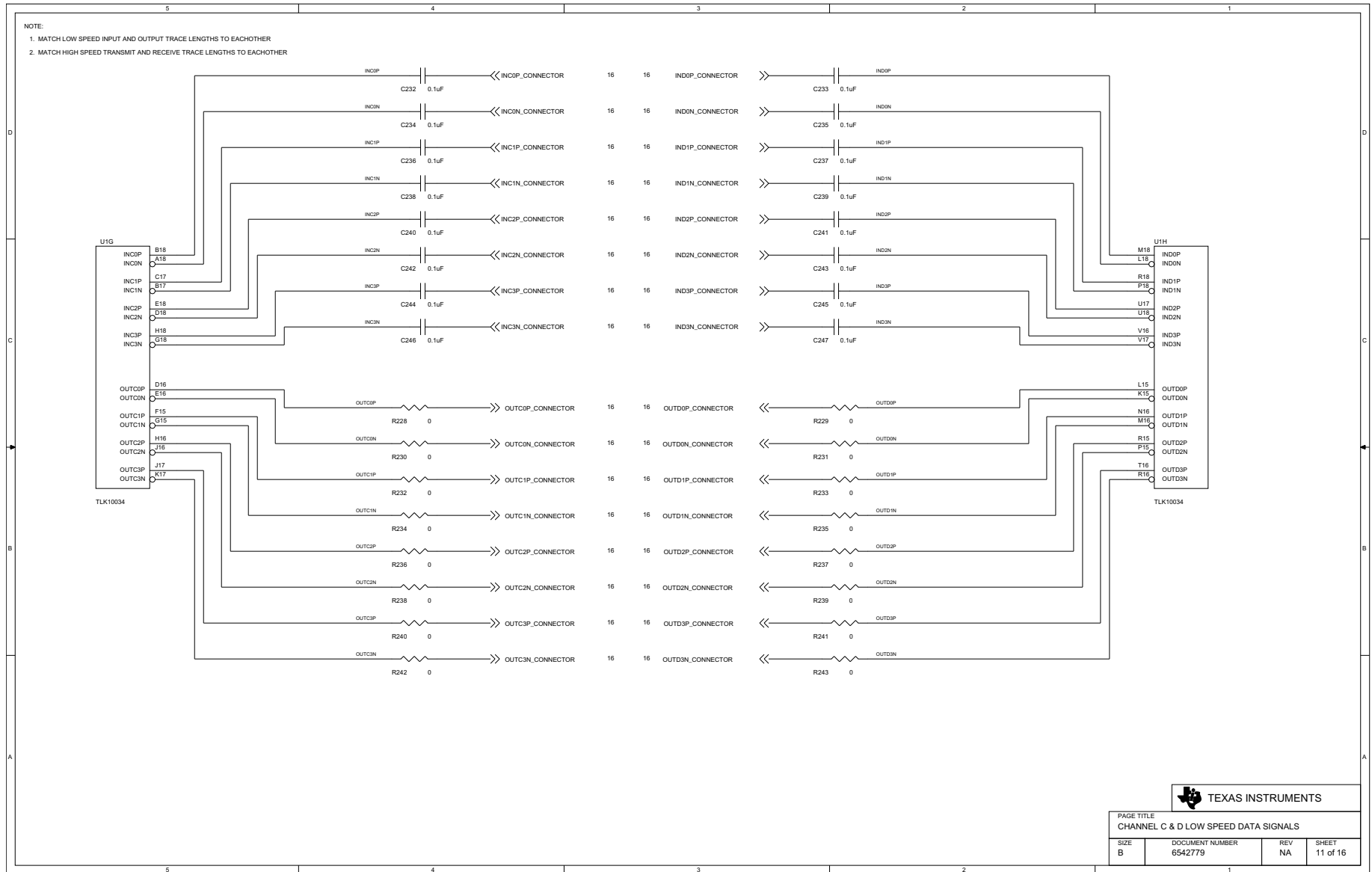

Figure 18. TLK10034 EVM Schematic, Channel C & D Low Speed Data Signals (Sheet 11 of 16)

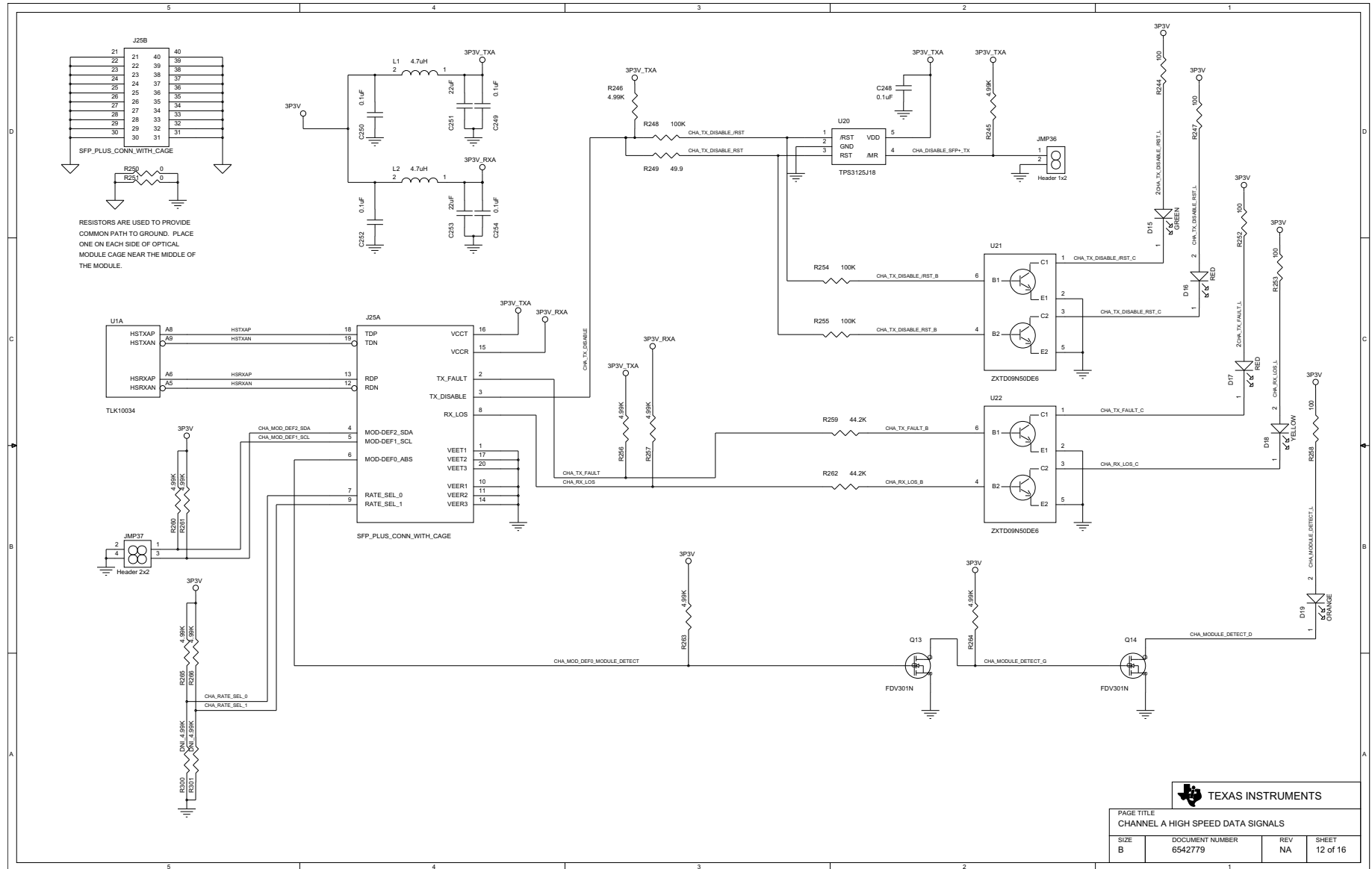

Figure 19. TLK10034 EVM Schematic, Channel A High Speed Data Signals (Sheet 12 of 16)

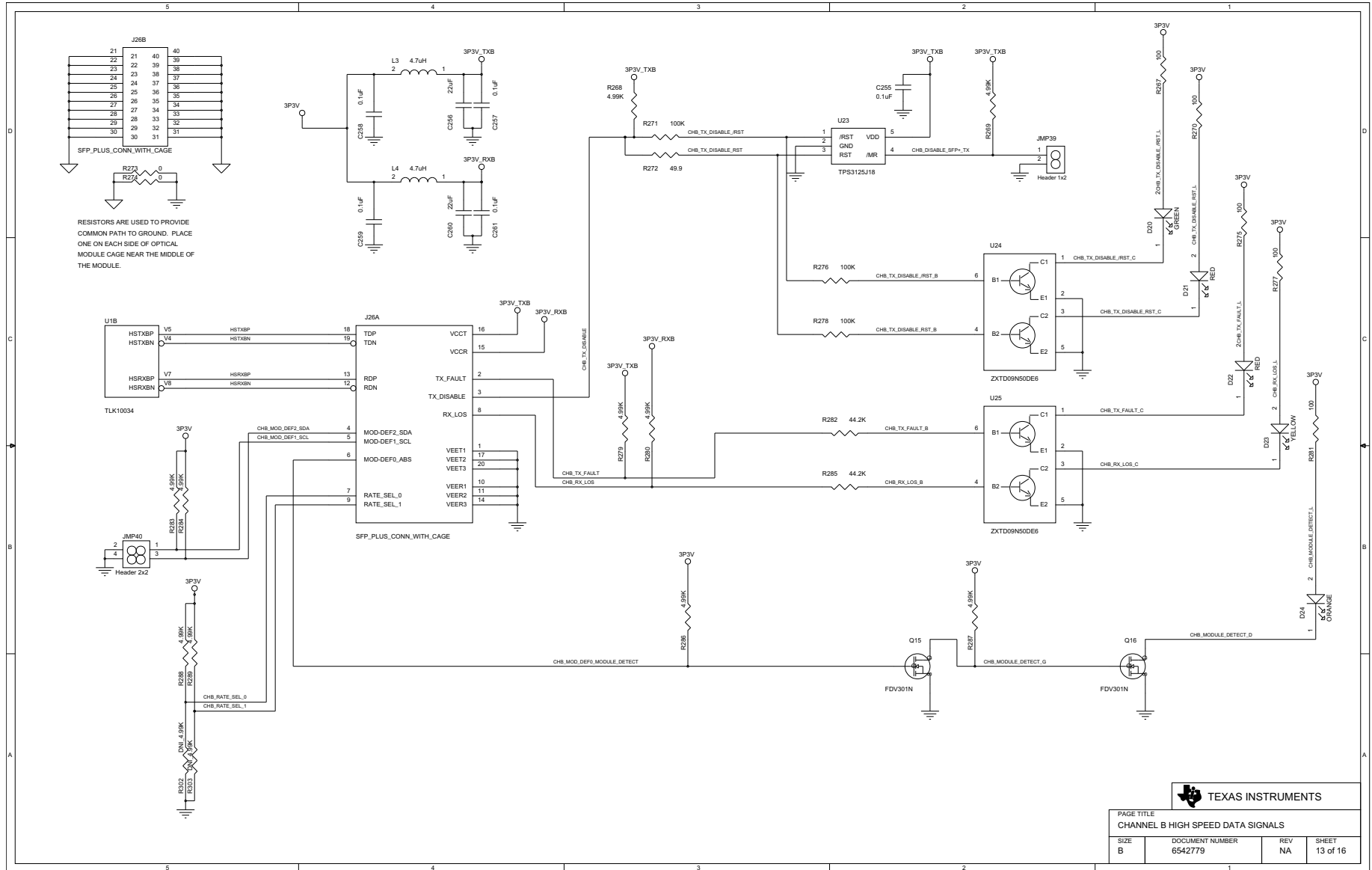

Figure 20. TLK10034 EVM Schematic, Channel B High Speed Data Signals (Sheet 13 of 16)

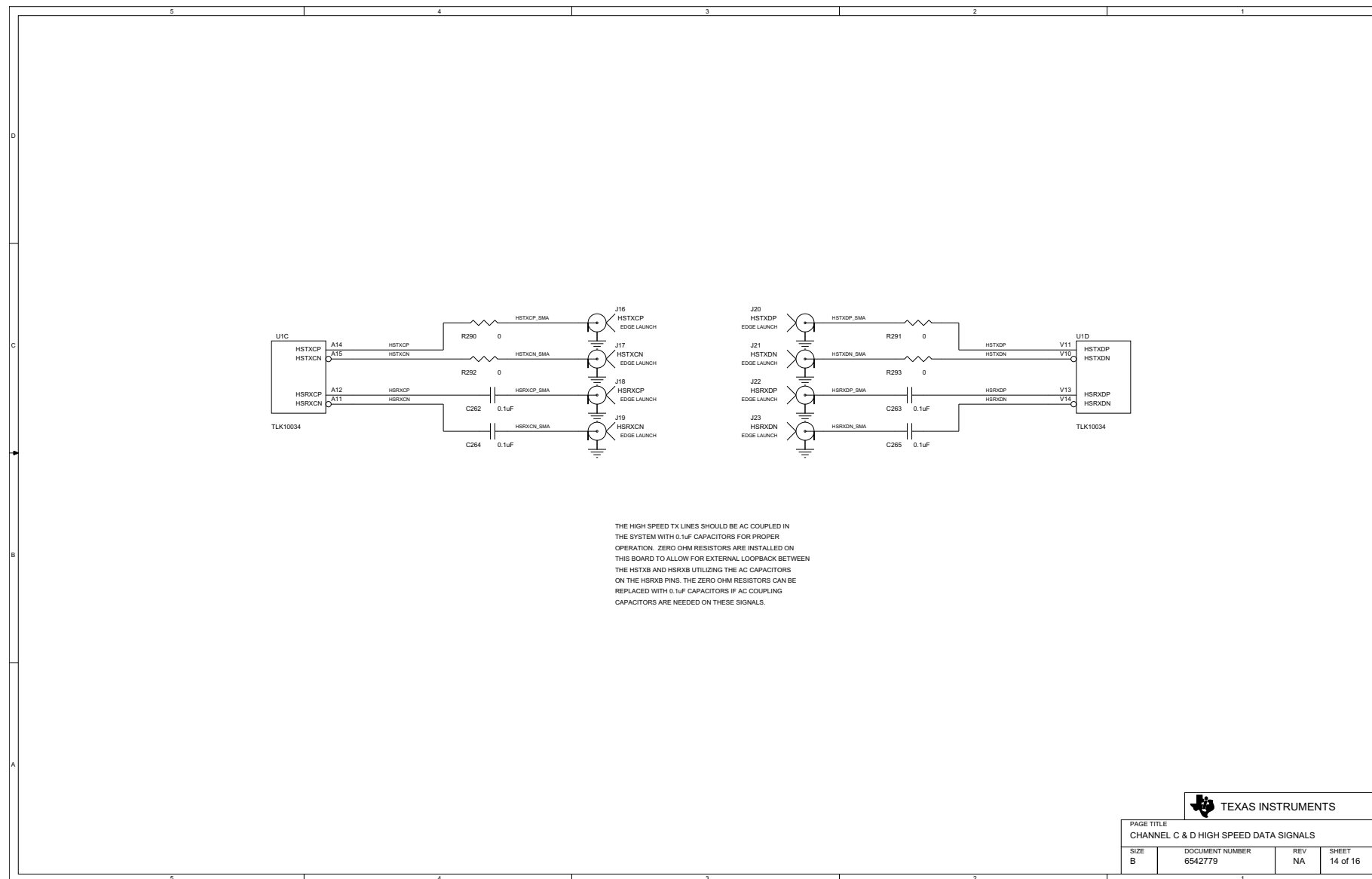

Figure 21. TLK10034 EVM Schematic, Channel C & D High Speed Data Signals (Sheet 14 of 16)

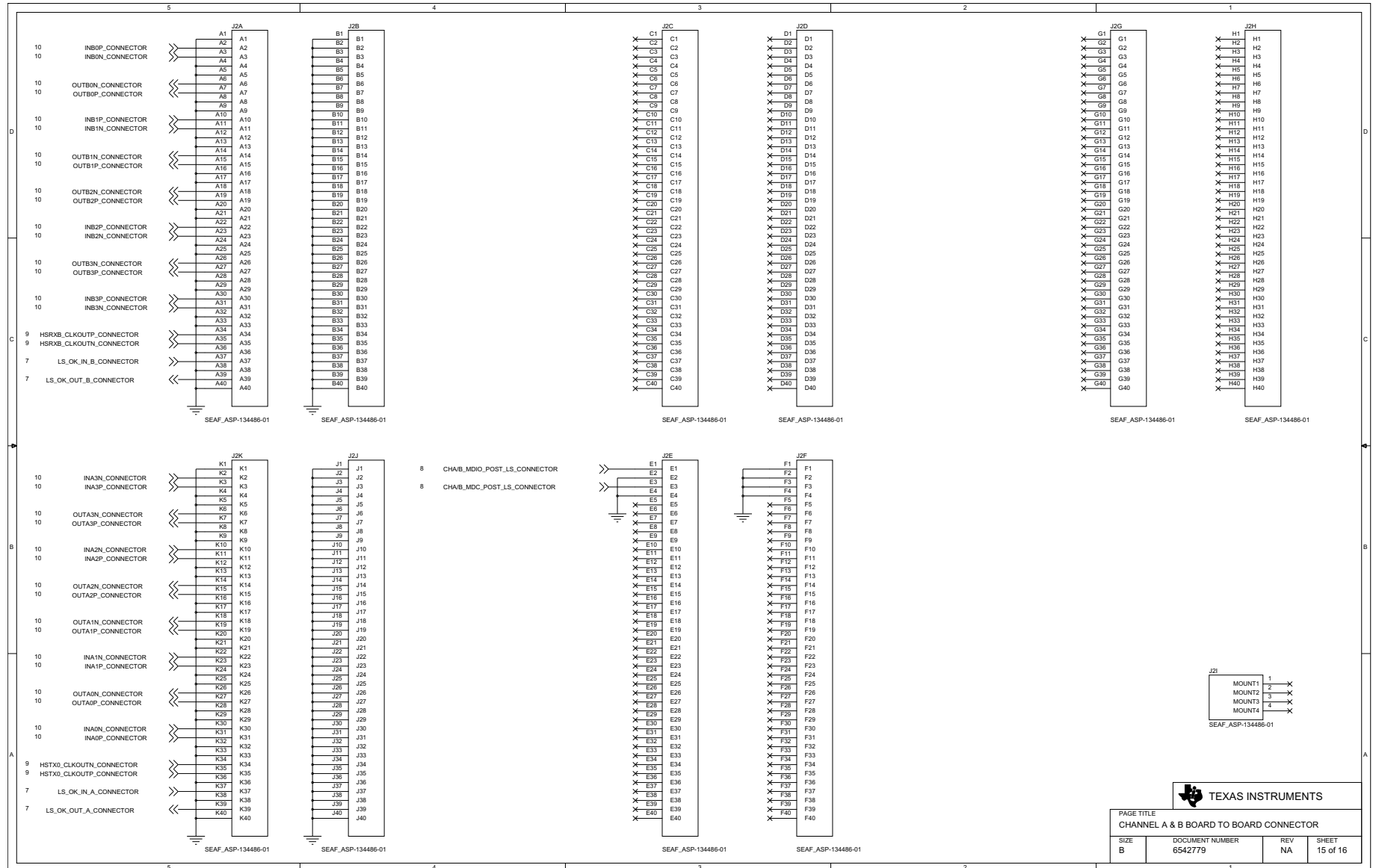

Figure 22. TLK10034 EVM Schematic, Channel A & B Board to Board Connector (Sheet 15 of 16)

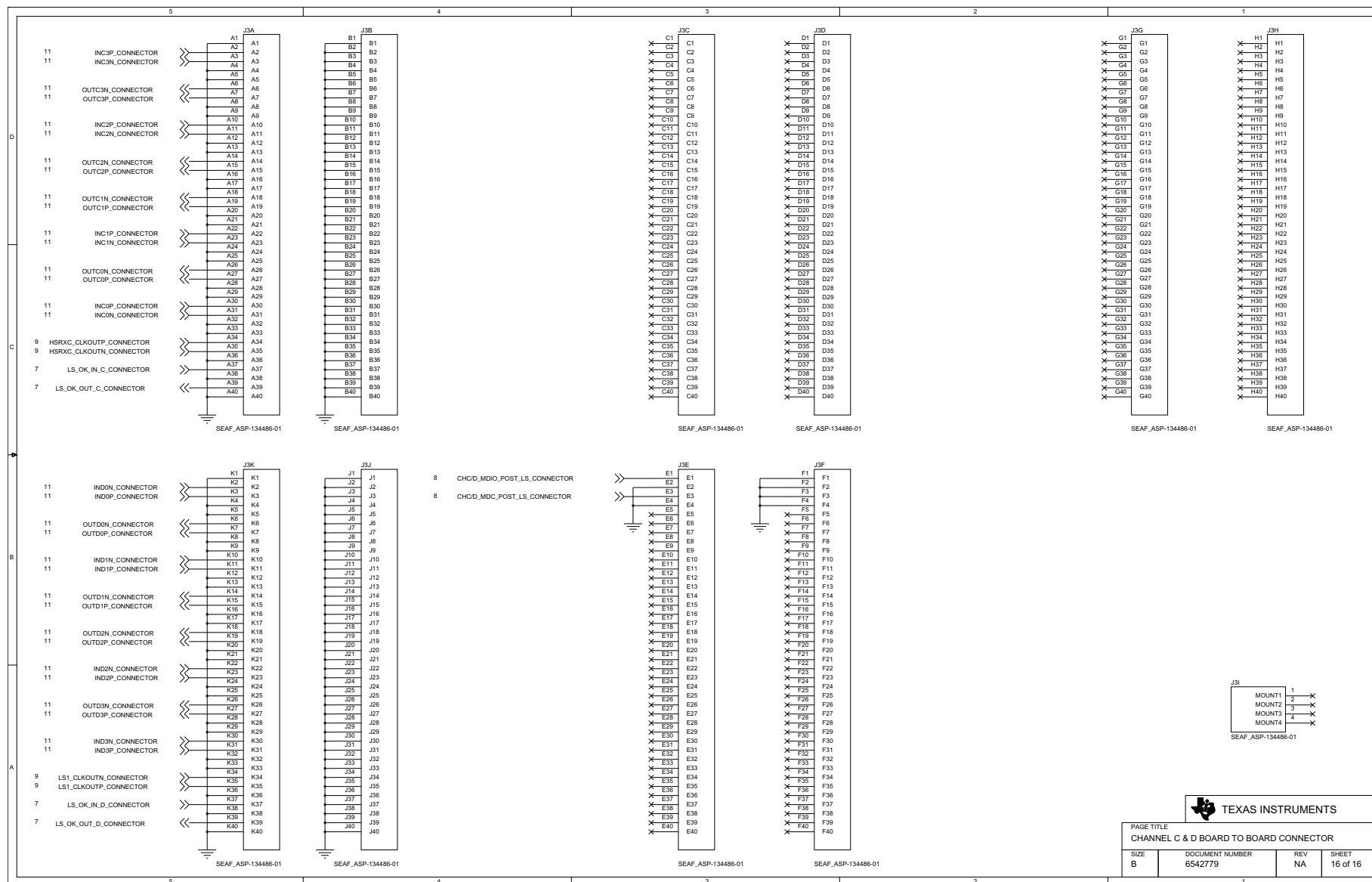

Figure 23. TLK10034 EVM Schematic, Channel C & D Board to Board Connector (Sheet 16 of 16)

12 TLK10034 EVM Motherboard Layout

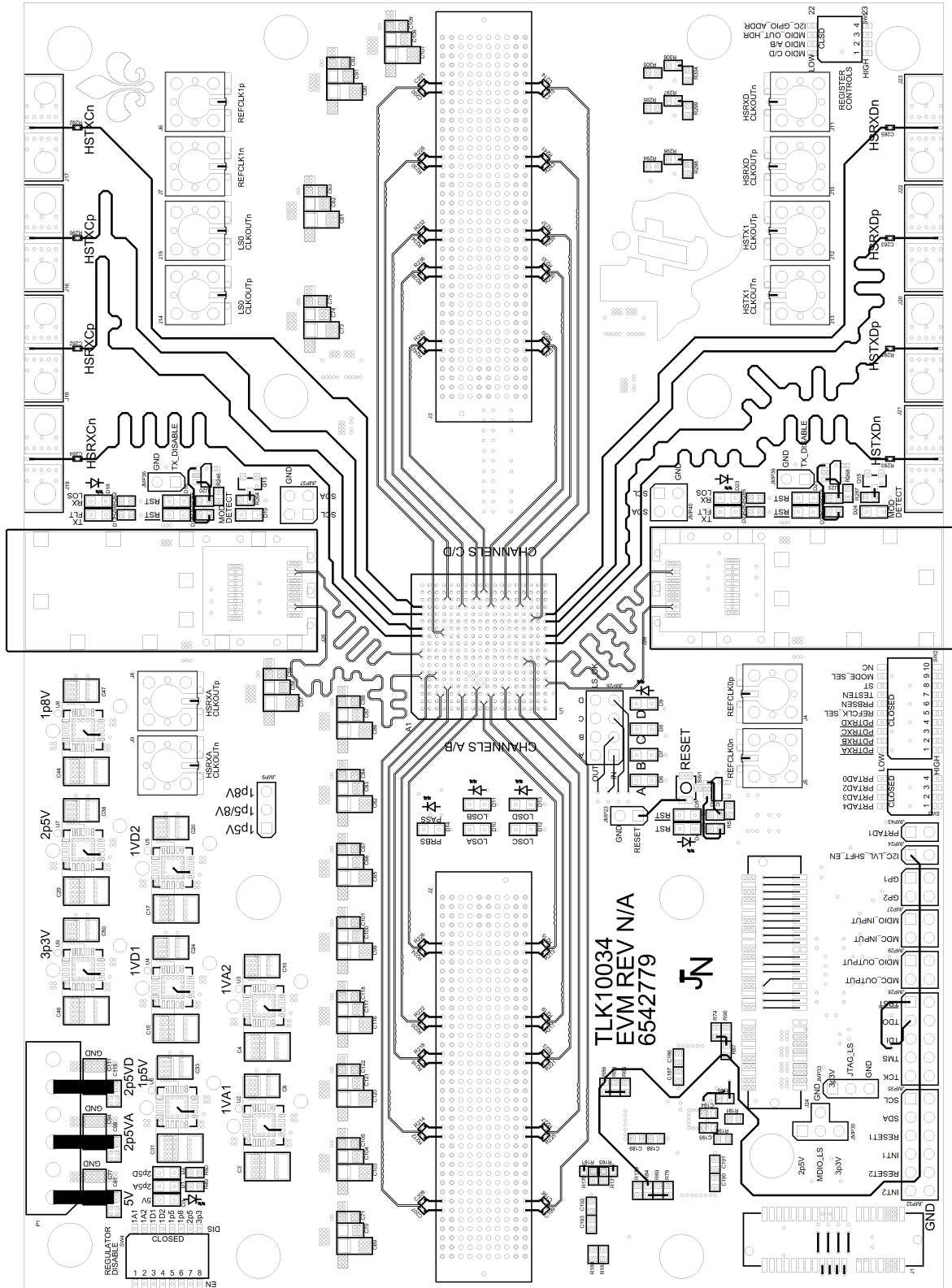

Figure 24. TLK10034 EVM Motherboard Layout, Top Signal (Layer 1)

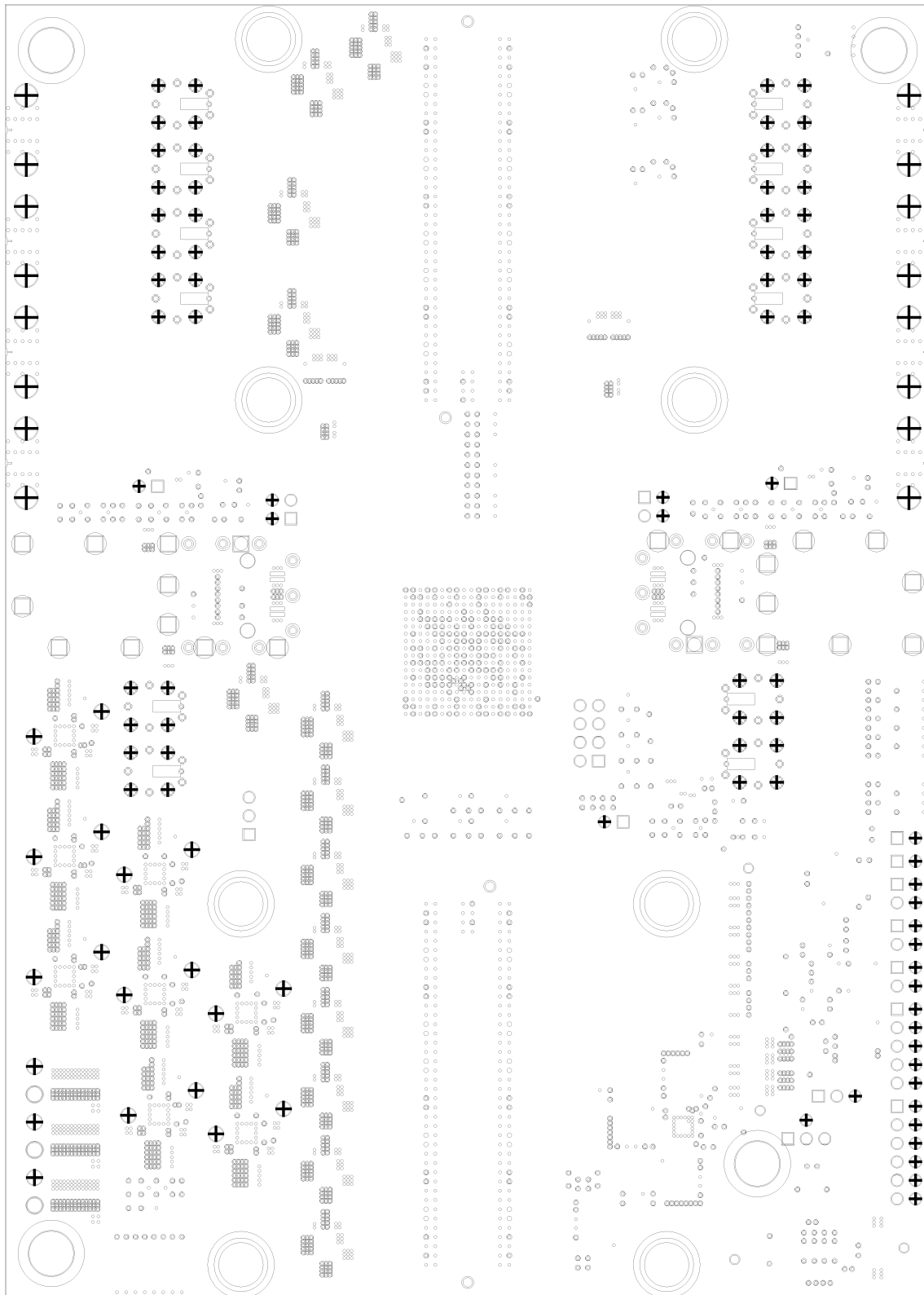

Figure 25. TLK10034 EVM Motherboard Layout, Internal Ground (Layer 2)

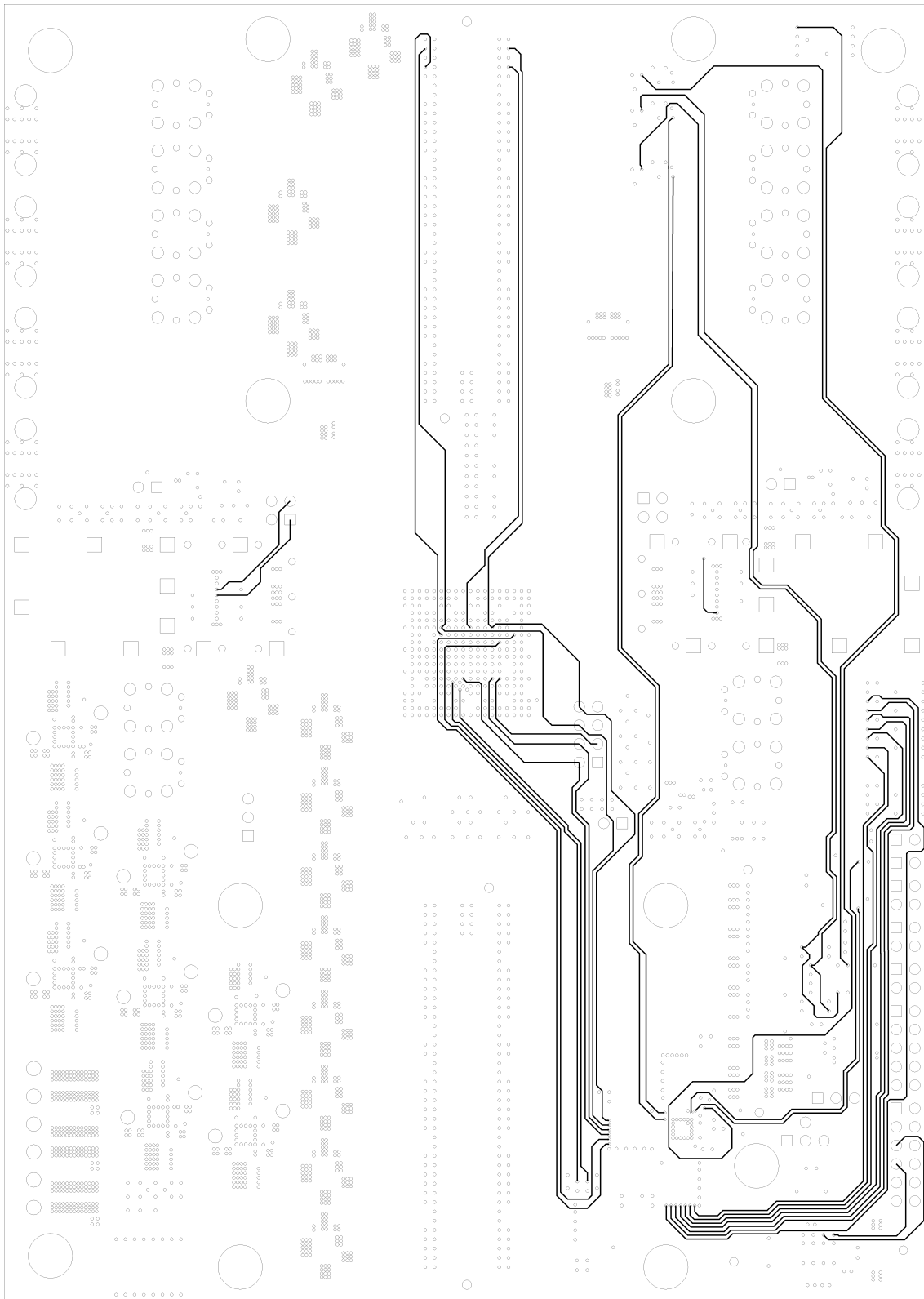

Figure 26. TLK10034 EVM Motherboard Layout, Internal Signal (Layer 3)

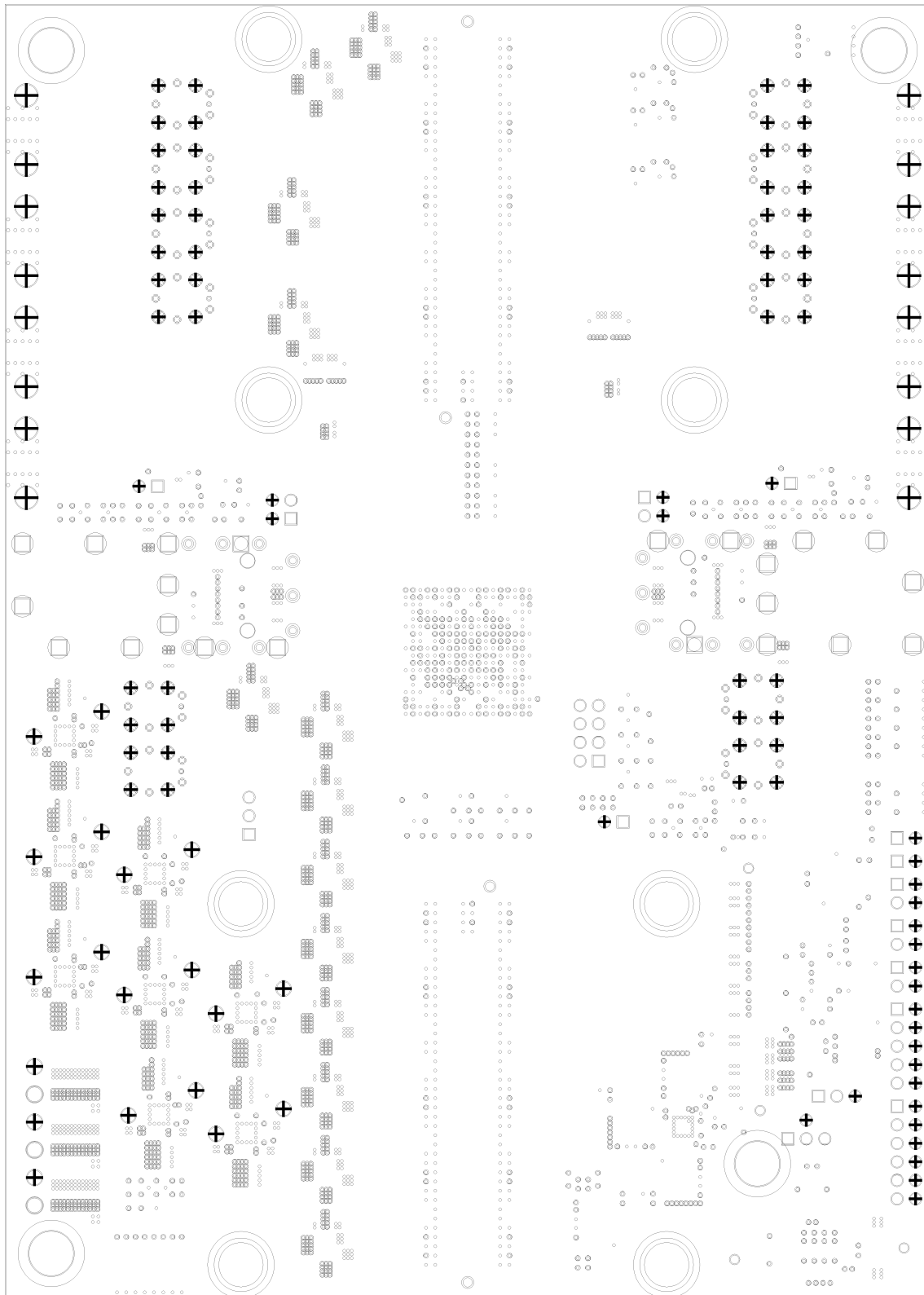

Figure 27. TLK10034 EVM Motherboard Layout, Internal Ground (Layers 6,8,11,13,15,17)

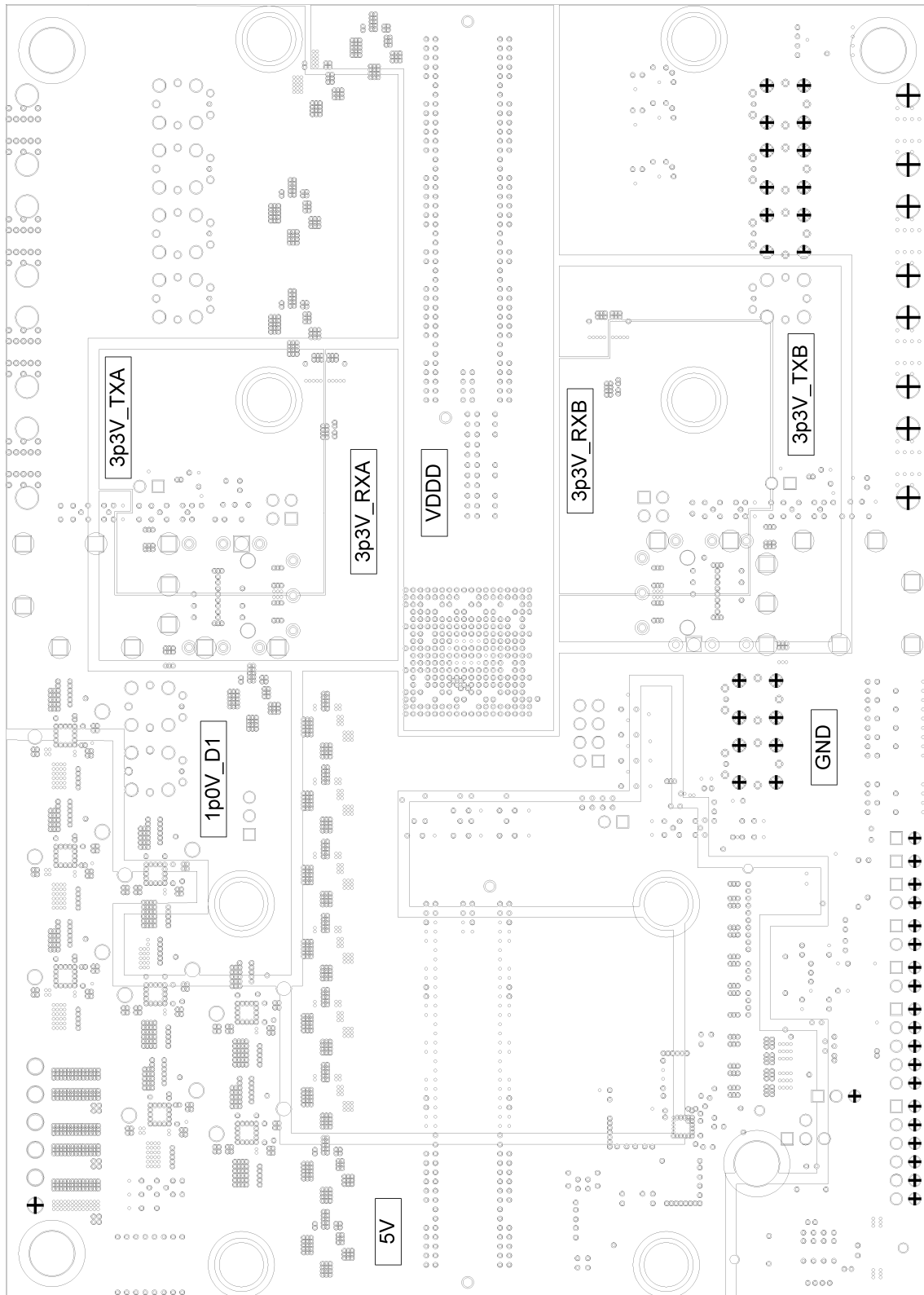

Figure 28. TLK10034 EVM Motherboard Layout, Internal Power (Layer 5)

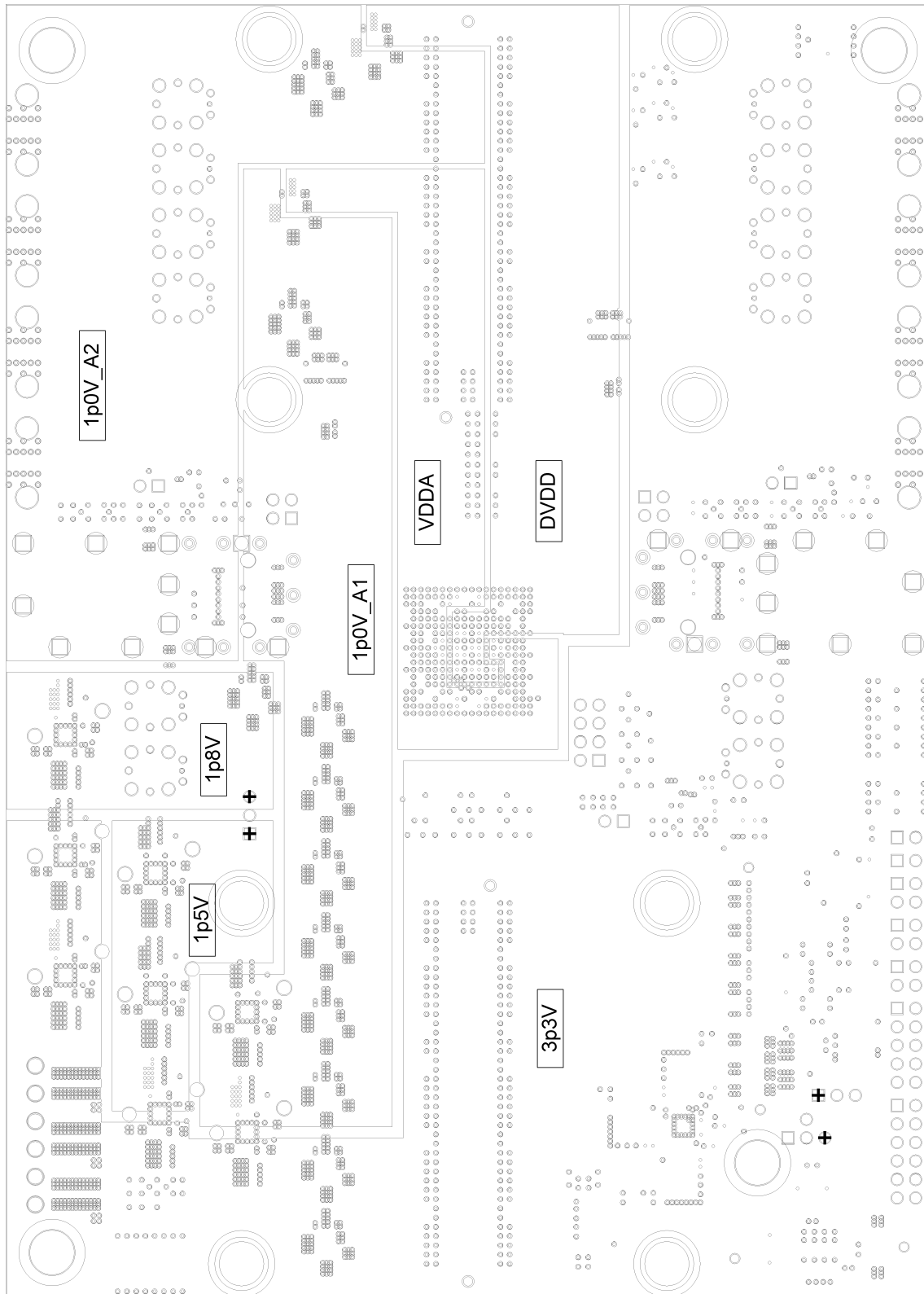

Figure 29. TLK10034 EVM Motherboard Layout, Internal Power (Layer 7)

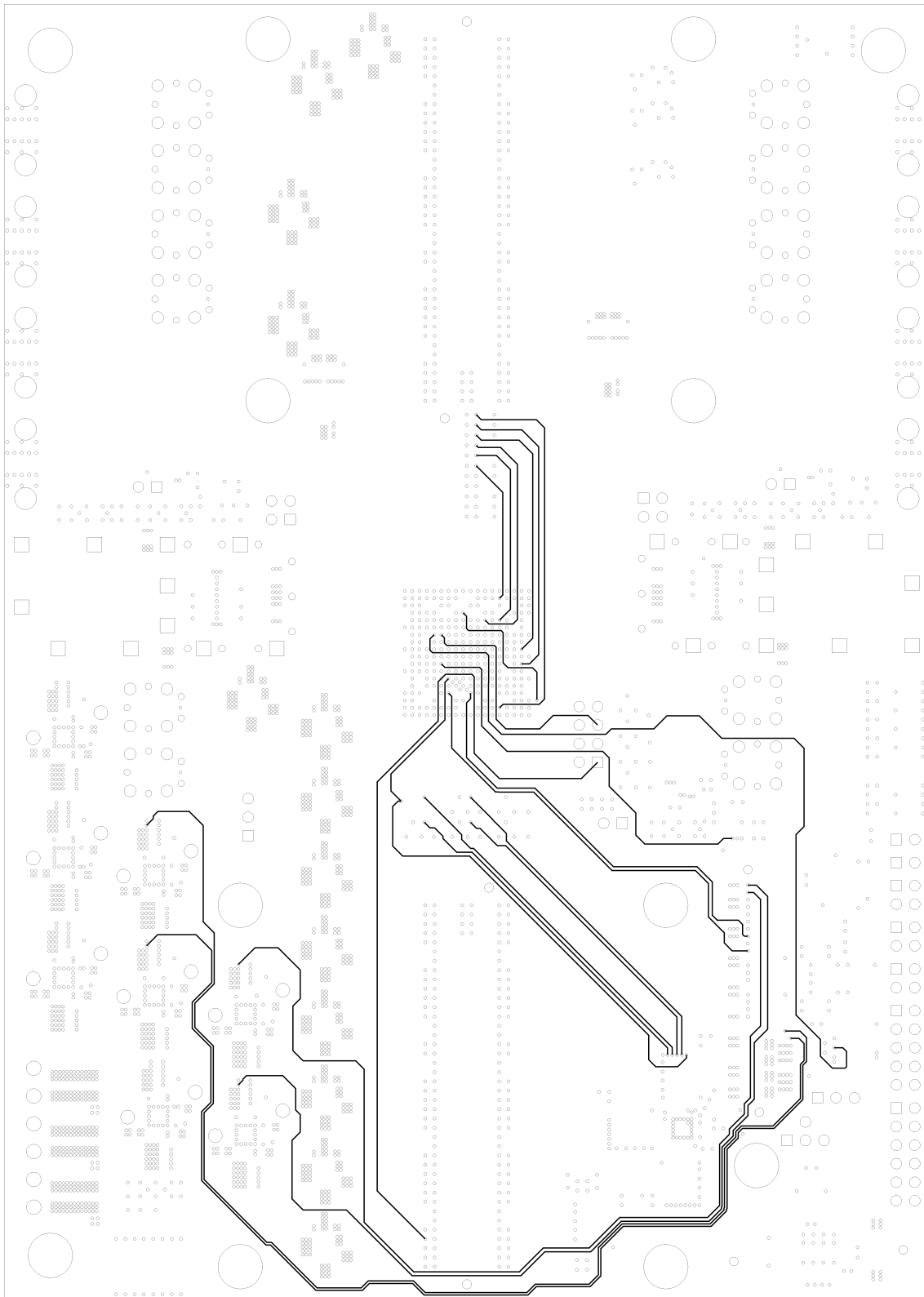

Figure 30. TLK10034 EVM Motherboard Layout, Internal Signal (Layer 9)

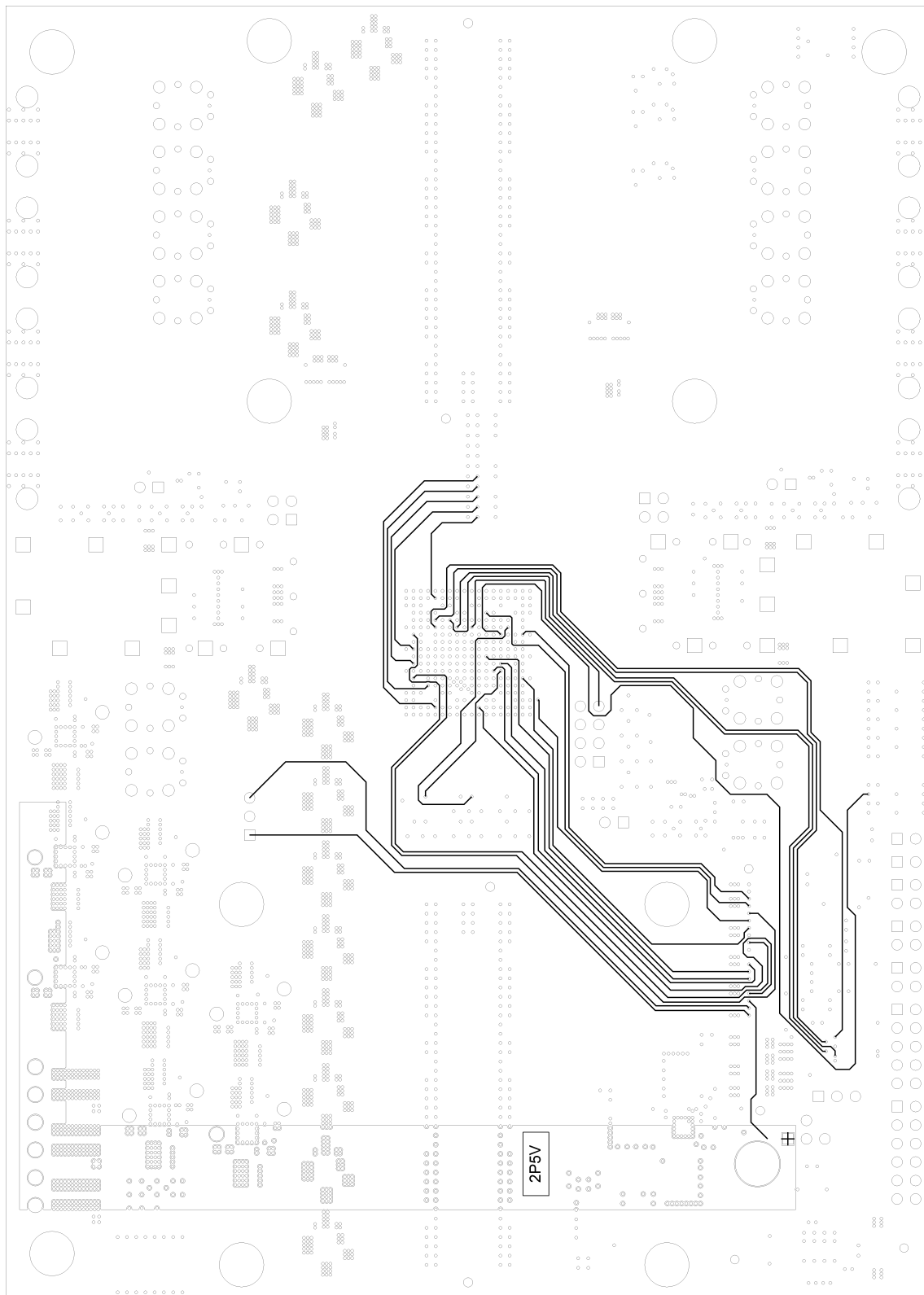

Figure 31. TLK10034 EVM Motherboard Layout, Internal Signal (Layer 10)

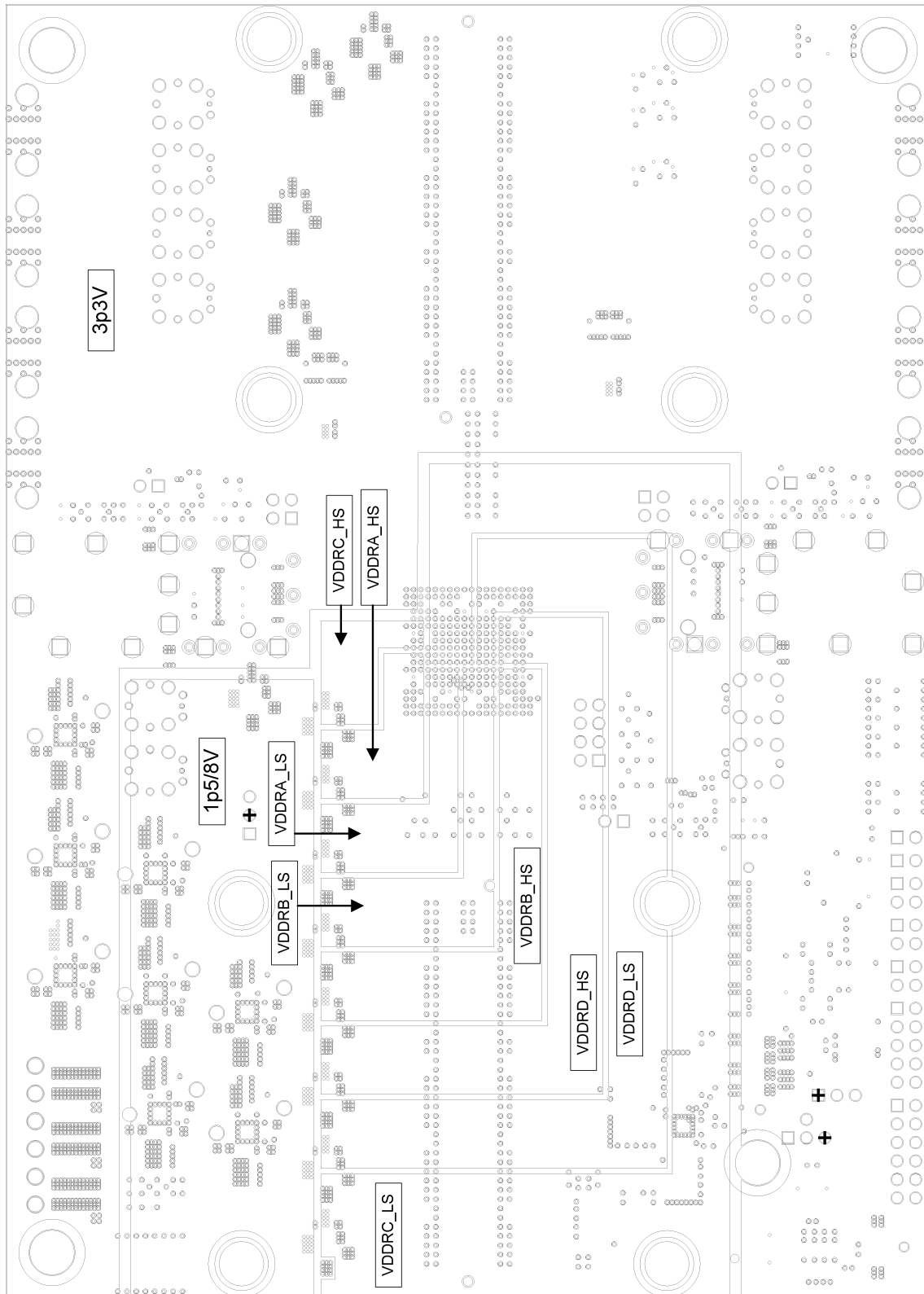

Figure 32. TLK10034 EVM Motherboard Layout, Internal Power (Layer 12)

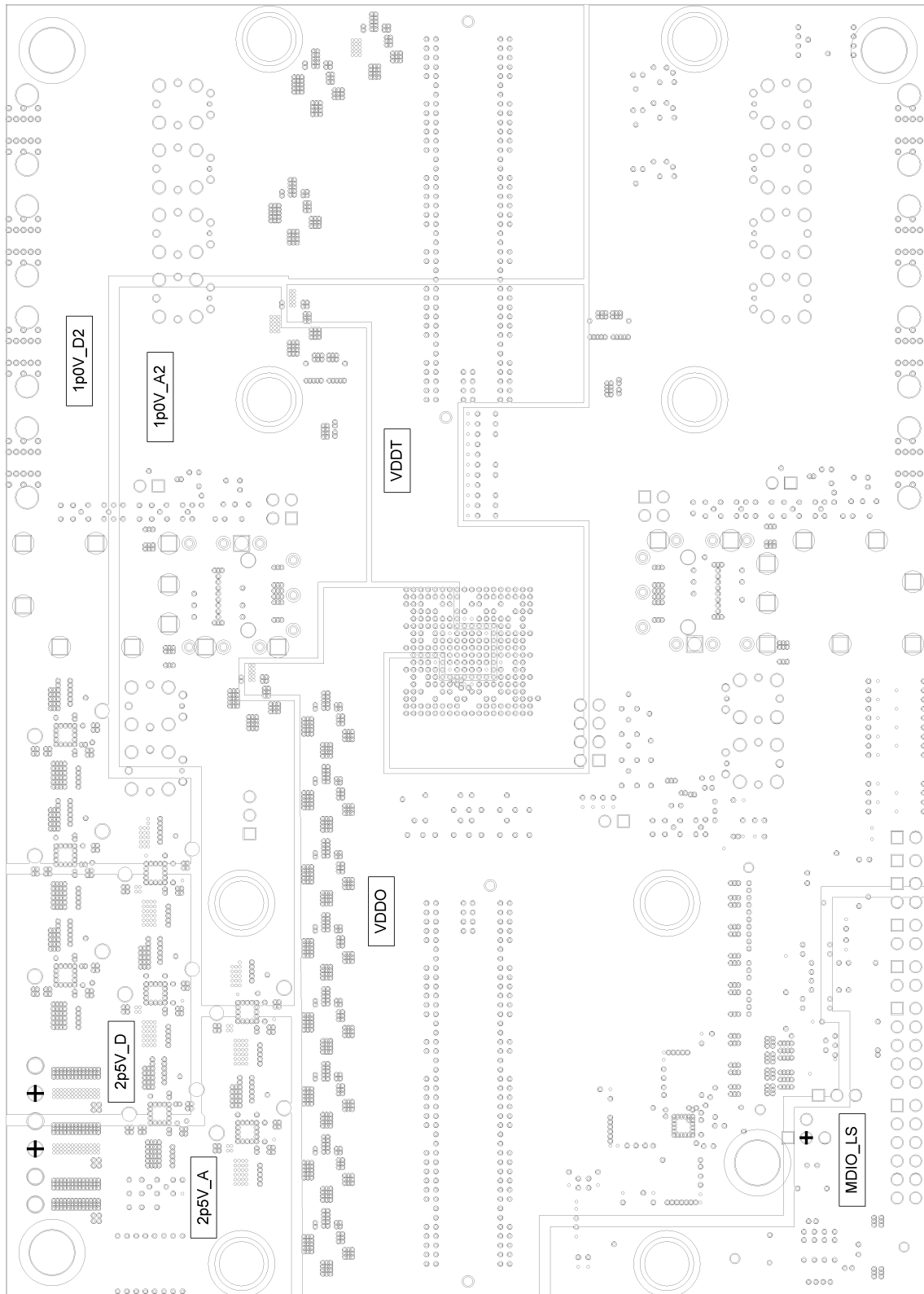

Figure 33. TLK10034 EVM Motherboard Layout, Internal Power (Layer 14)

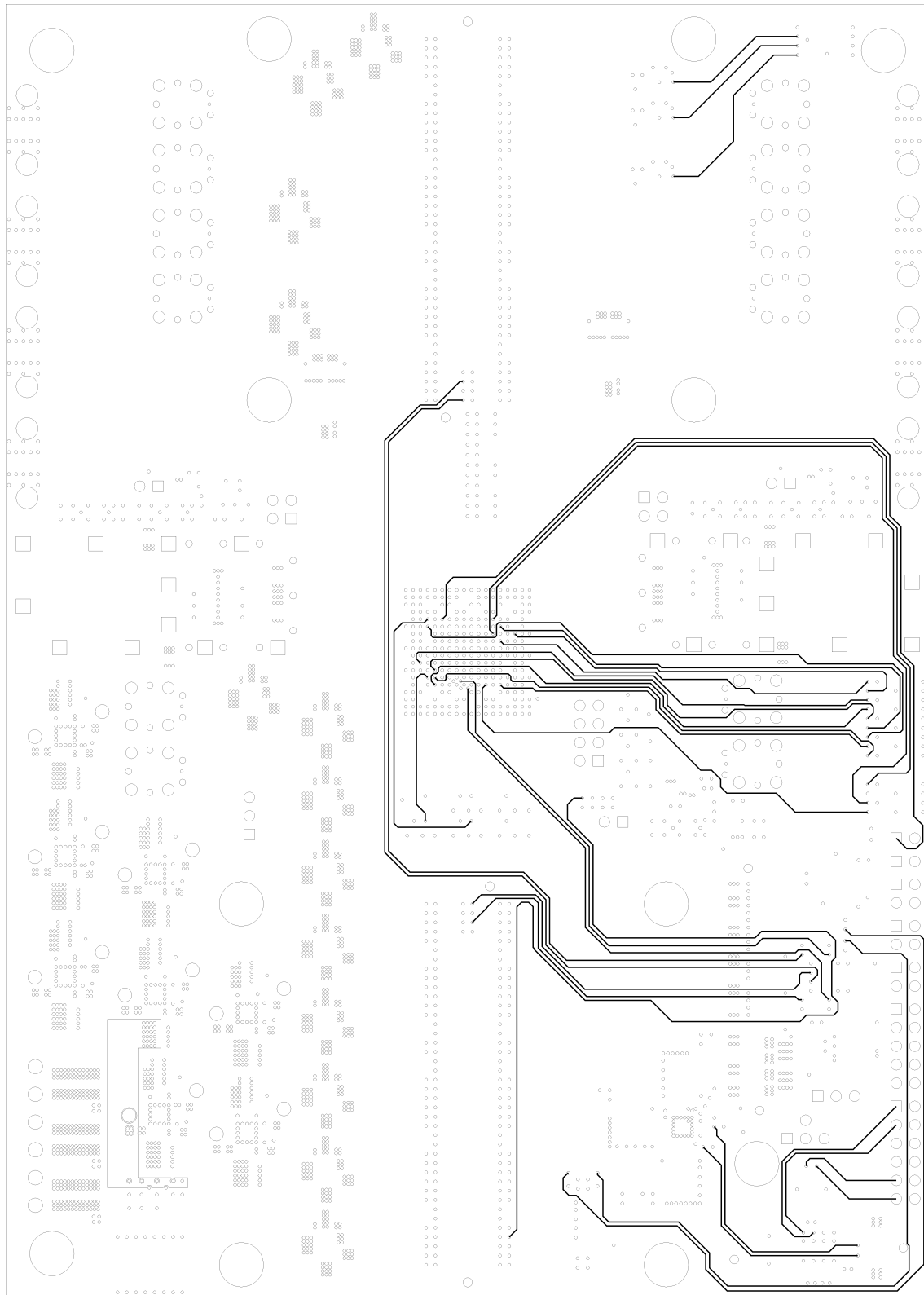

Figure 34. TLK10034 EVM Motherboard Layout, Internal Signal (Layer 16)

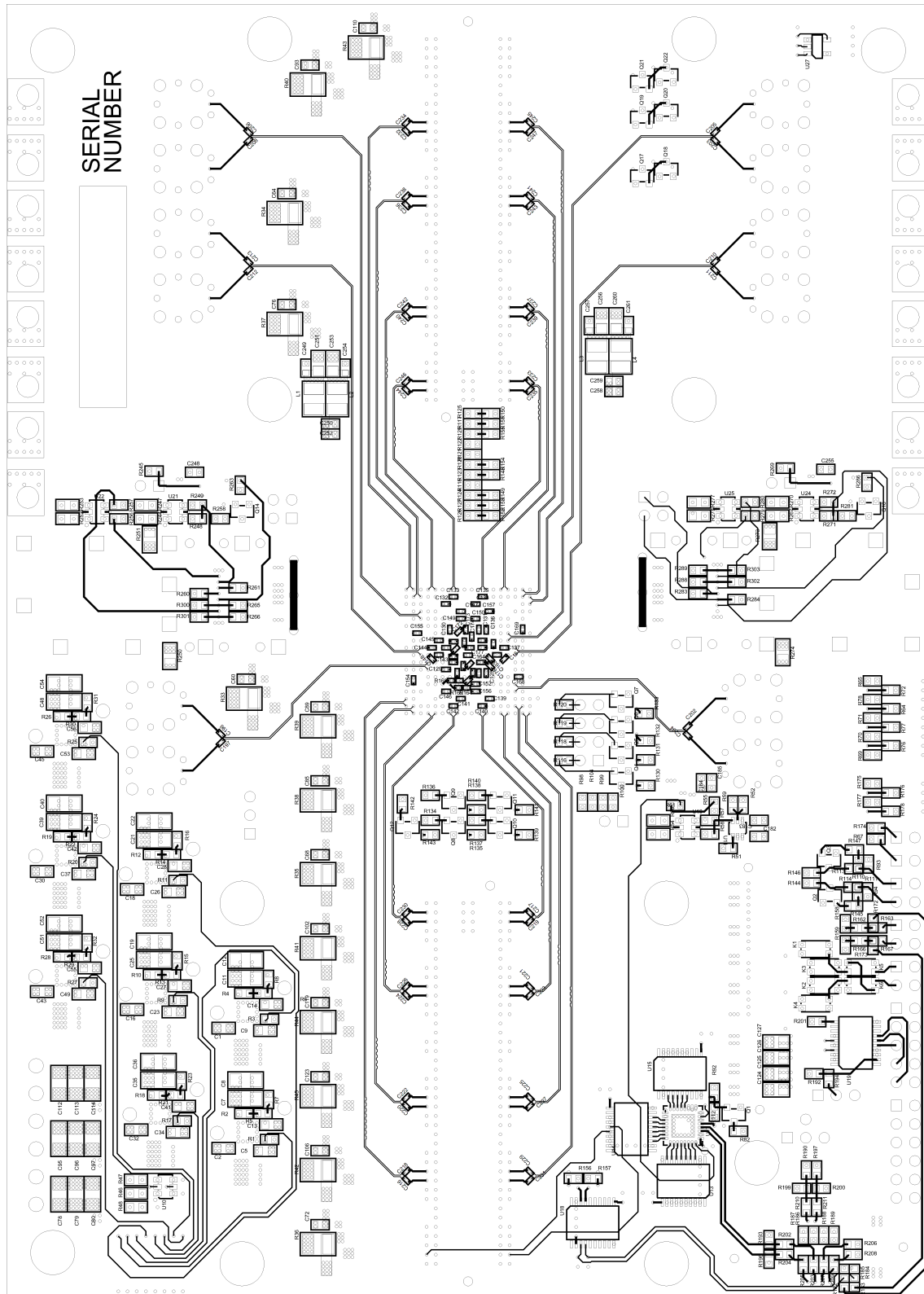

Figure 35. TLK10034 EVM Motherboard Layout, Bottom Signal (Layer 18 Top View)

Table 1. TLK10034 EVM Motherboard Layer Construction

Subclass Name	Type	Material	Thickness (MIL)	Dielectric Constant	Width (MIL)	Coupling Type / Spacing (MIL)
	SURFACE	AIR		1		
TOP	CONDUCTOR	COPPER	2	1	3.75 (Diff) 11.25 (Single)	Edge / 4.0 (Diff) None/None (Single)
	DIELECTRIC	Rogers	6.6	3.7		
L2_GND	PLANE	COPPER	1.2	1		
	DIELECTRIC	FR-4	8	4.5		
L3_SIG2	CONDUCTOR	COPPER	1.2	1	6.50 (Single)	None/None (Single)
	DIELECTRIC	FR-4	8	4.5		
L4_GND	PLANE	COPPER	1.2	1		
	DIELECTRIC	FR-4	5	4.5		
L5_PWR	CONDUCTOR	COPPER	1.2	1	6.50 (Single)	None/None (Single)
	DIELECTRIC	FR-4	5	4.5		
L6_GND	PLANE	COPPER	1.2	1		
	DIELECTRIC	FR-4	5	4.5		
L7_PWR	PLANE	COPPER	1.2	1		
	DIELECTRIC	FR-4	5	4.5		
L8_GND	PLANE	COPPER	1.2	1		
	DIELECTRIC	FR-4	5	4.5		
L9_SIG	CONDUCTOR	COPPER	1.2	1	6.50 (Single)	None/None (Single)
	DIELECTRIC	FR-4	5	4.5		
L10_SIG	CONDUCTOR	COPPER	1.2	1	6.50 (Single)	None/None (Single)
	DIELECTRIC	FR-4	5	4.5		
L11_GND	PLANE	COPPER	1.2	1		
	DIELECTRIC	FR-4	5	4.5		
L12_PWR	CONDUCTOR	COPPER	1.2	1	6.50 (Single)	None/None (Single)
	DIELECTRIC	FR-4	5	4.5		
L13_GND	PLANE	COPPER	1.2	1		
	DIELECTRIC	FR-4	5	4.5		
L14_PWR	PLANE	COPPER	1.2	1		
	DIELECTRIC	FR-4	5	4.5		
L15_GND	PLANE	COPPER	1.2	1		
	DIELECTRIC	FR-4	8	4.5		
L16_SIG	CONDUCTOR	COPPER	1.2	1	6.50 (Single)	None/None (Single)
	DIELECTRIC	FR-4	8	4.5		
L17_GND	PLANE	COPPER	1.2	1		
	DIELECTRIC	Rogers	6.6	3.7		
BOTTOM	CONDUCTOR	COPPER	2	1	3.75 (Diff) 11.25 (Single)	Edge / 4.0 (Diff) None/None (Single)
	SURFACE	AIR				

NOTE: The impedance is set at slightly less than 50 or 100 Ω on the traces to compensate for slight over-etching during the manufacturing process. The end impedance after etching should result in a 50- or 100- Ω impedance. Always consult with your board manufacturer for their process and design requirements, ensuring the desired impedance is achieved.

13 TLK10034 EVM SMA Breakout Board Schematics



	5	4	3	2	1																												
NOTES: 1. PLACE NET NAMES ON ALL JUMPERS AND HEADERS. 2. PLACE ALL PARTS OTHER THAN SMA CONNECTORS ON A 0 OR 90 DEGREE ORIENTATION. 3. SERIAL DATA SHOULD BE ROUTED AS 100 OHM DIFFERENTIALLY COUPLED OR SINGLE-ENDED 50 OHM TRANSMISSION LINES ON OUTSIDE LAYERS. ROUTING DISTANCE SHOULD BE 5 INCHES OR LESS. ALL OTHER DATA LINES SHOULD BE 50 OHM IMPEDIANCE ON INTERNAL OR EXTERNAL LAYERS. ROUTED POWER SHOULD BE A MINIMUM OF 40 MILS WIDE. 4. USE FR4-370 MATERIAL FOR ALL LAYERS. 5. SERIAL AND REFCLK NETS MUST MATCH WITHIN +/- 0.5 MILS 6. MATCH DIFFERENTIAL TRACE WIDTHS OF SERIAL AND REFCLK LINES WITH SMP/SMA PADS. 7. PLACE TI LOGO, BOARD NAME, JN COMBO LOGO, AND THE BOARD NUMBER IN TOP SIDE METAL.	<div style="border: 1px solid black; padding: 10px; width: fit-content; margin: auto;"> <p>SCHEMATIC SHEET INDEX:</p> <hr style="width: 50%; margin: 5px auto;"/> <p>SHEET 01: TLK10034 EVM SMA BREAKOUT DAUGHTER BOARD COVER SHEET AND NOTES</p> <p>SHEET 02: CHANNEL A/D SIGNALS</p> <p>SHEET 03: CHANNEL B/C SIGNALS</p> <p>SHEET 04: COMMON SIGNALS</p> </div>																																
<table border="1" style="width: 100%; border-collapse: collapse;"> <tr> <td colspan="4" style="text-align: center;"> TEXAS INSTRUMENTS</td> </tr> <tr> <td colspan="4" style="font-size: small;">SCHEMATIC TITLE</td> </tr> <tr> <td colspan="4" style="font-size: small;">TLK10034 EVM SMA BREAKOUT DAUGHTER BOARD</td> </tr> <tr> <td colspan="4" style="font-size: small;">PAGE TITLE</td> </tr> <tr> <td colspan="4" style="font-size: small;">COVER PAGE AND NOTES</td> </tr> <tr> <td style="font-size: x-small;">SIZE</td> <td style="font-size: x-small;">DOCUMENT NUMBER</td> <td style="font-size: x-small;">REV</td> <td style="font-size: x-small;">SHEET</td> </tr> <tr> <td style="font-size: x-small;">B</td> <td style="font-size: x-small;">6544328</td> <td style="font-size: x-small;">NA</td> <td style="font-size: x-small;">1 of 4</td> </tr> </table>	 TEXAS INSTRUMENTS				SCHEMATIC TITLE				TLK10034 EVM SMA BREAKOUT DAUGHTER BOARD				PAGE TITLE				COVER PAGE AND NOTES				SIZE	DOCUMENT NUMBER	REV	SHEET	B	6544328	NA	1 of 4					
 TEXAS INSTRUMENTS																																	
SCHEMATIC TITLE																																	
TLK10034 EVM SMA BREAKOUT DAUGHTER BOARD																																	
PAGE TITLE																																	
COVER PAGE AND NOTES																																	
SIZE	DOCUMENT NUMBER	REV	SHEET																														
B	6544328	NA	1 of 4																														
	5	4	3	2	1																												

Figure 36. TLK10034 EVM SMA Breakout Board Schematic, Sheet 1 Cover Page and Index

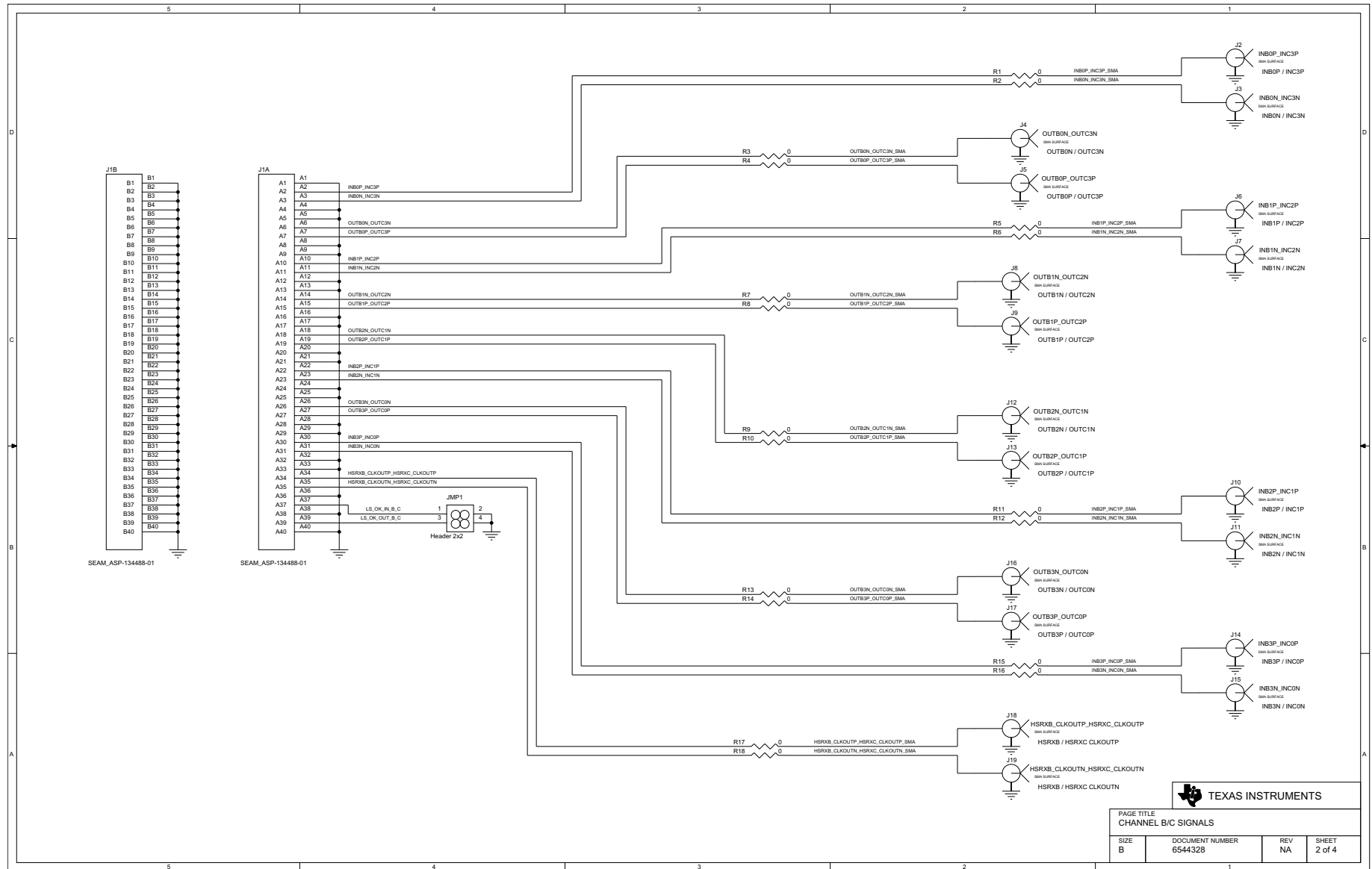

Figure 37. TLK10034 EVM SMA Breakout Board Schematic, Sheet 2 Channel B/C Signals

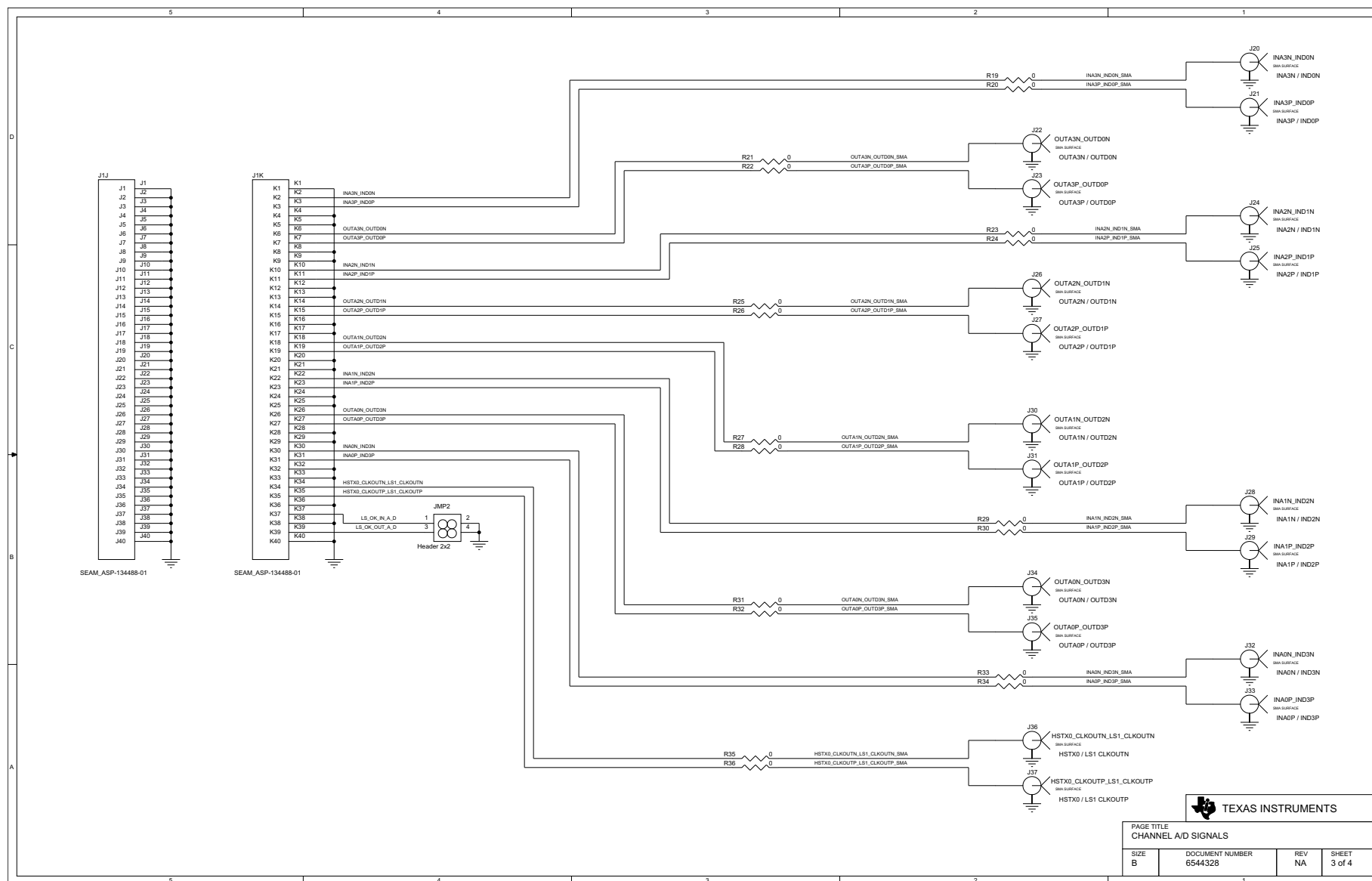

Figure 38. TLK10034 EVM SMA Breakout Board Schematic, Sheet 3 Channel A/D Signals

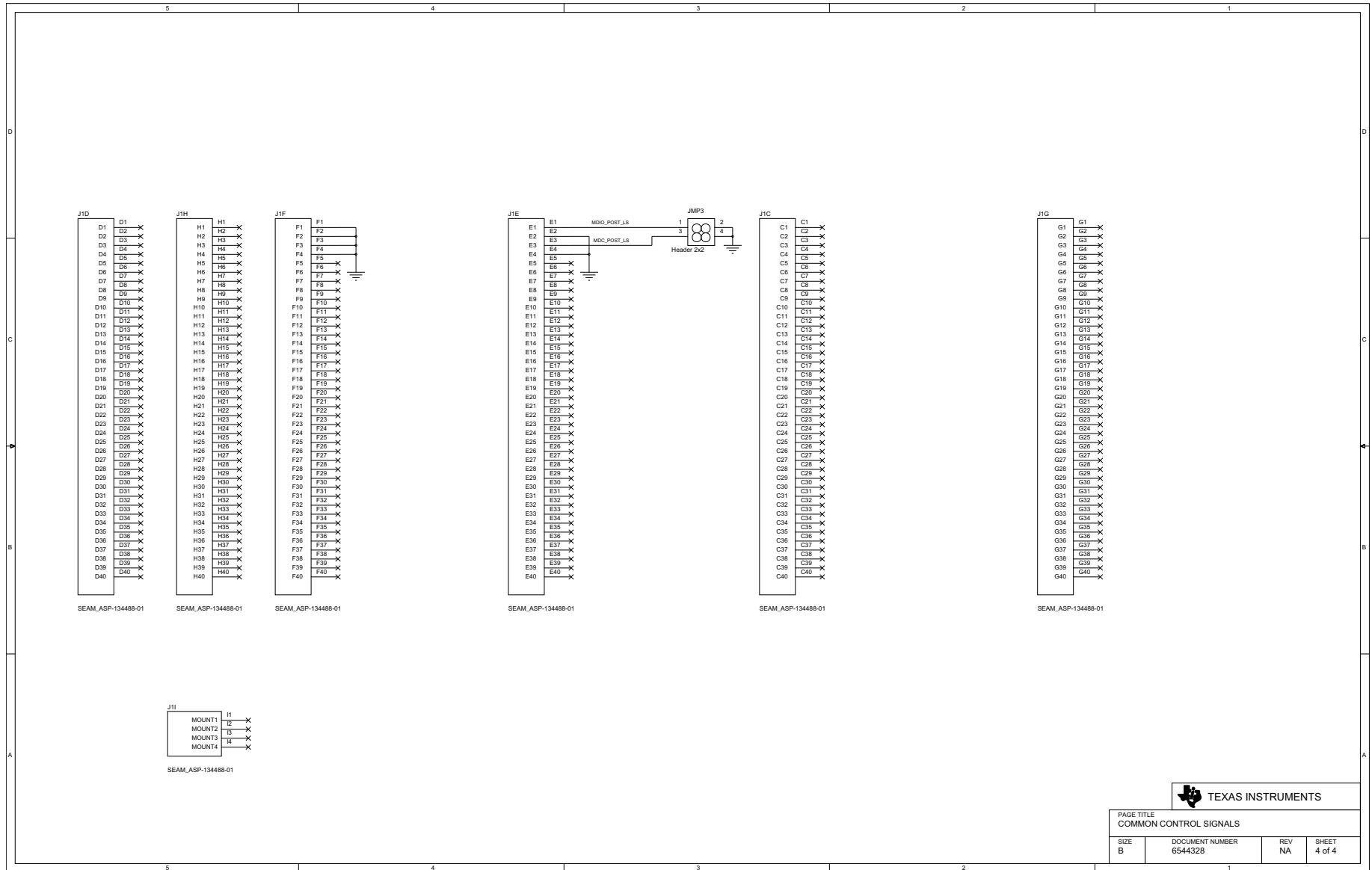

Figure 39. TLK10034 EVM SMA Breakout Board Schematic, Sheet 4 Common Control Signals

14 TLK10034 EVM SMA Breakout Board Layout

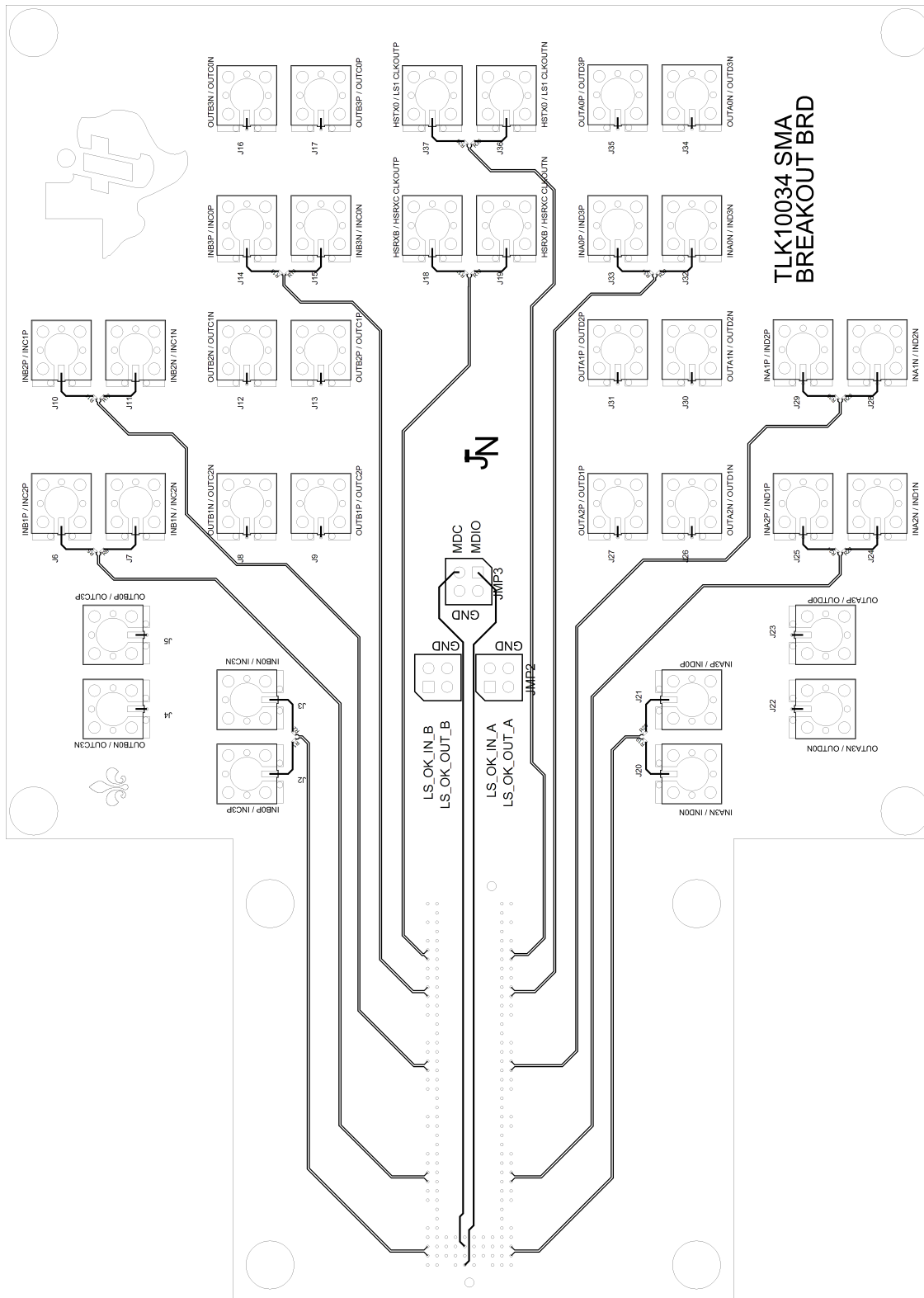

Figure 40. TLK10034 EVM SMA Breakout Board Layout, Top Signal (Layer 1)

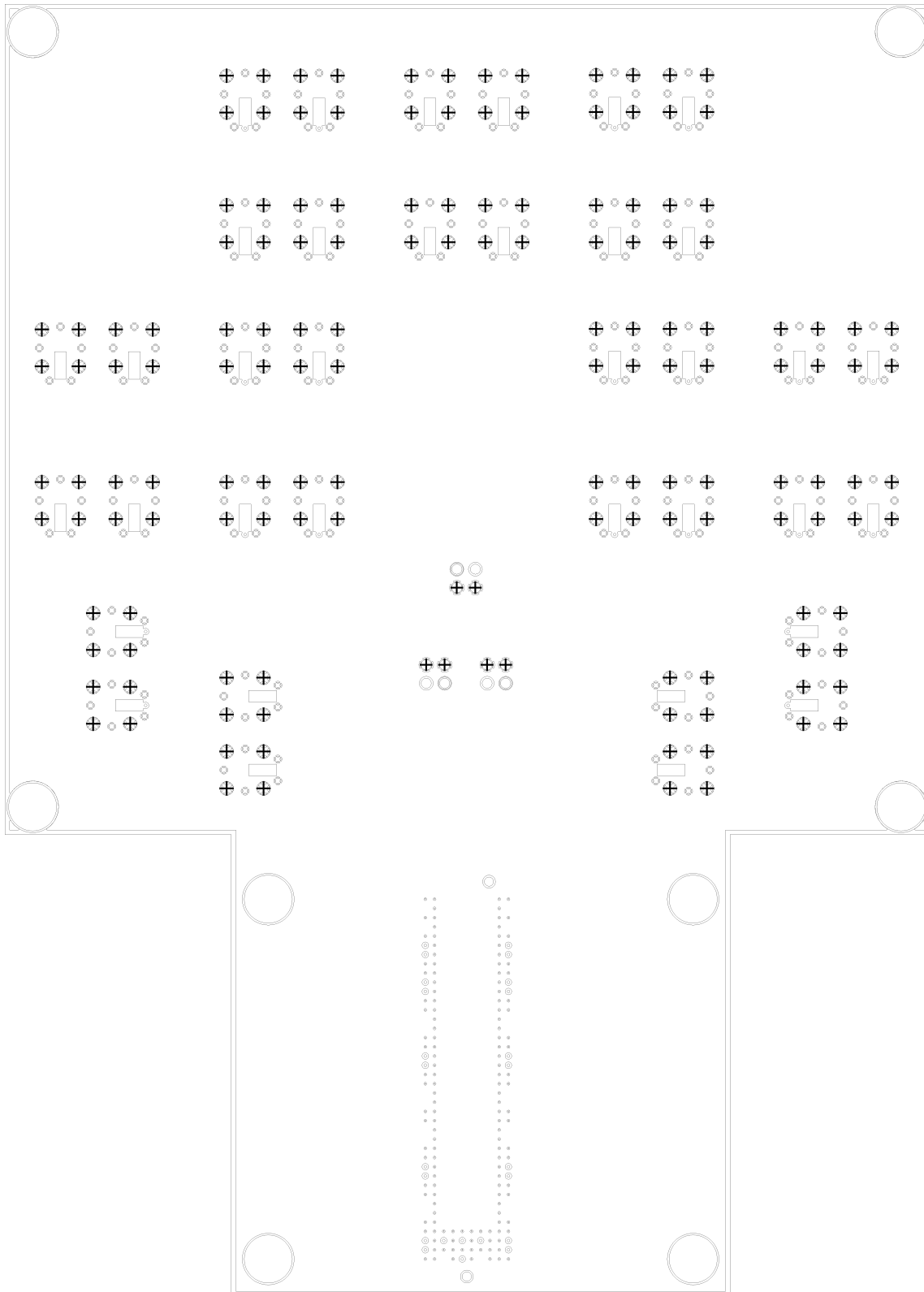

Figure 41. TLK10034 EVM SMA Breakout Board Layout, Internal Ground (Layer 2)

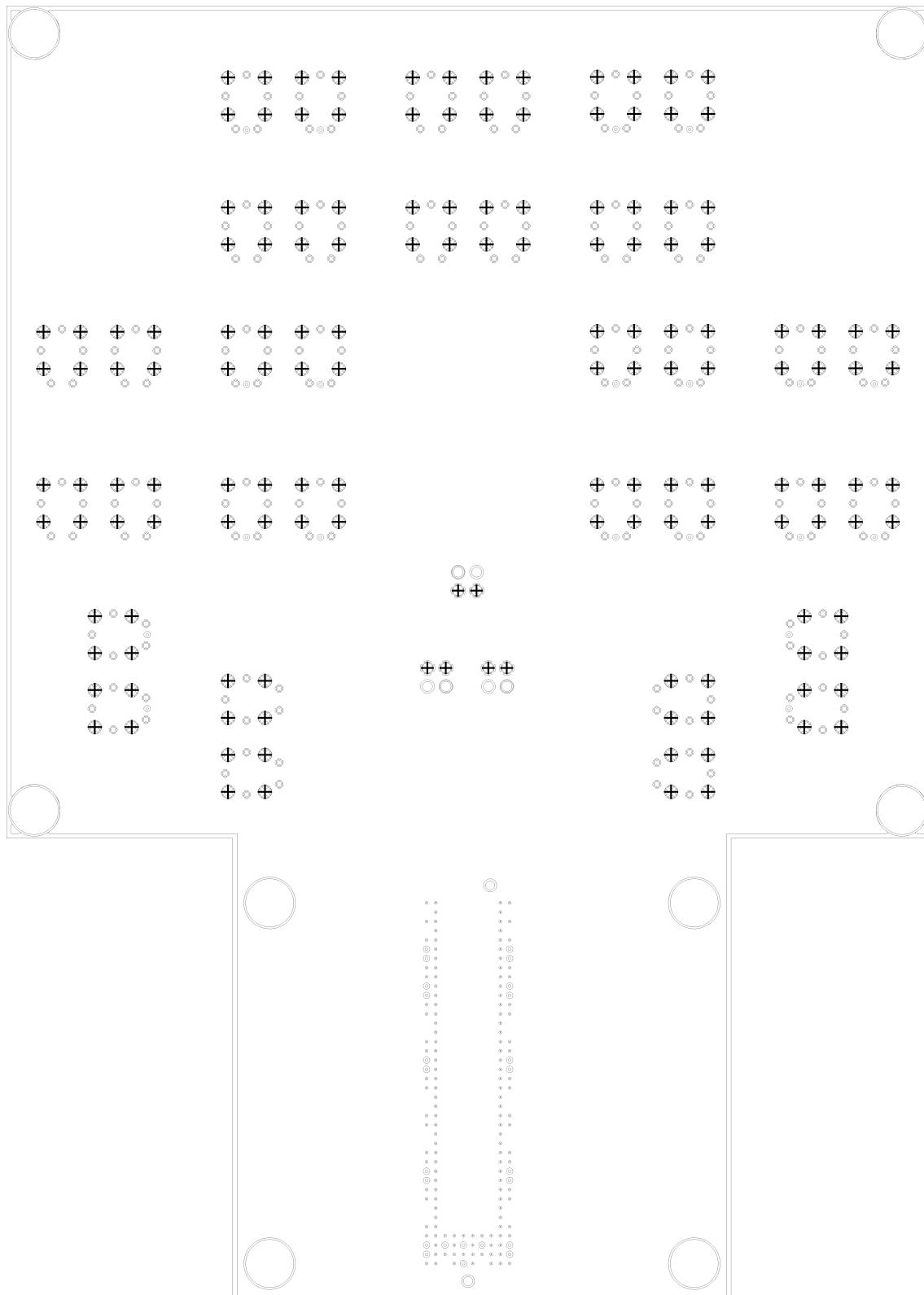

Figure 42. TLK10034 EVM SMA Breakout Board Layout, Internal GND (Layers 3,4,5)

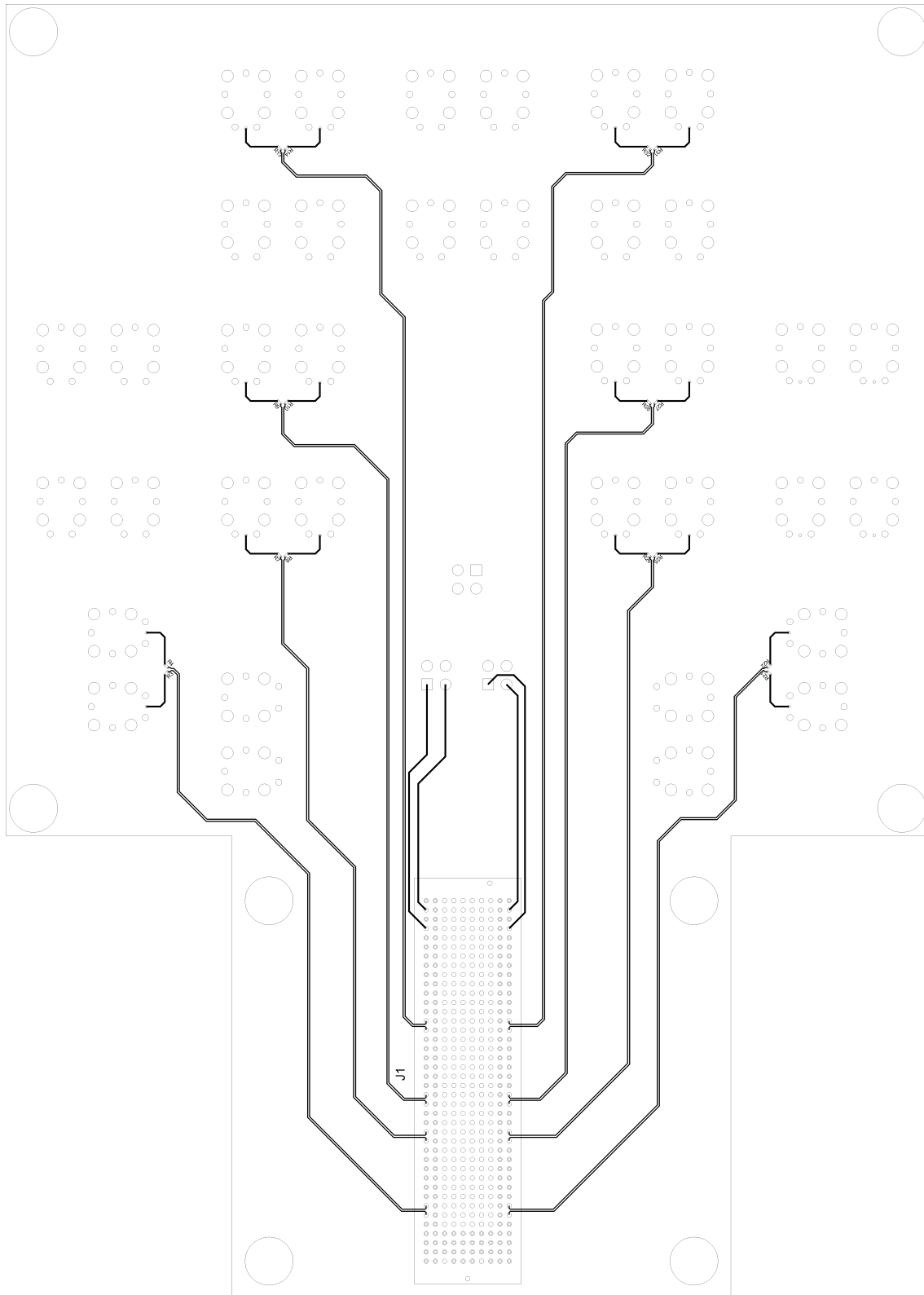

Figure 43. TLK10034 EVM SMA Breakout Board Layout, Bottom Signal (Layers 6)

Table 2. TLK10034 EVM SMA Breakout Board Layer Construction

Subclass Name	Type	Material	Thickness (MIL)	Dielectric Constant	Width (MIL)	Coupling Type / Spacing (MIL)
	SURFACE	AIR		1		
TOP	CONDUCTOR	COPPER	2	1	6.00 (Diff) 9.5 (Single)	Edge / 5.0 (Diff) None/None (Single)
	DIELECTRIC	FR-4	5	4.5		
L2_GND	PLANE	COPPER	1.2	1		
	DIELECTRIC	FR-4	20	4.5		
L3_GND	PLANE	COPPER	1.2	1	6.50 (Single)	None/None (Single)
	DIELECTRIC	FR-4	4	4.5		
L4_GND	PLANE	COPPER	1.2	1		
	DIELECTRIC	FR-4	20	4.5		
BOTTOM	CONDUCTOR	COPPER	2	1	6.00 (Diff) 9.5 (Single)	None/None (Single) Edge / 5.0 (Diff)
	SURFACE	AIR				

NOTE: The impedance is set at slightly less than 50 or 100 Ω on the traces to compensate for slight over-etching during the manufacturing process. The end impedance after etching should result in a 50- or 100- Ω impedance. Always consult with your board manufacturer for their process and design requirements, ensuring the desired impedance is achieved.

15 TLK10034 EVM Voltage-Monitor Board Schematics



NOTES: 1. PLACE NET NAMES ON ALL JUMPERS AND HEADERS. 2. PLACE ALL PARTS ON A 0 OR 90 DEGREE ORIENTATION. 3. VOLTAGE SENSE LINES SHOULD BE ROUTED AS WIDE AS POSSIBLE TO REDUCE IR DROP. 4. USE FR4-370 MATERIAL FOR ALL LAYERS. 5. PLACE TI LOGO IN TOP SIDE METAL 6. PCB MUST BE 0.062 INCHES THICK 7. MATES WITH SAMTEC CONNECTOR (MEC1-130-02-F-D-A)	<div style="border: 1px solid black; padding: 10px; width: fit-content; margin: auto;"> <h3 style="margin: 0;">SCHEMATIC SHEET INDEX:</h3> <p style="margin: 5px 0 0 20px;">SHEET 01: TLK10034 VOLTAGE MONITOR COVER SHEET AND NOTES</p> <p style="margin: 5px 0 0 20px;">SHEET 02: 1P0V_D1, 1P0V_D2, 2P5V, 3P3V LEDS</p> <p style="margin: 5px 0 0 20px;">SHEET 03: 1P5V AND 1P8V REG, AND VDDO LEDS</p> <p style="margin: 5px 0 0 20px;">SHEET 04: VDDA, VDDT, VDDD, AND DVDD LEDS</p> <p style="margin: 5px 0 0 20px;">SHEET 05: VDDRA_LS AND VDDRA_HS LEDS</p> <p style="margin: 5px 0 0 20px;">SHEET 06: VDDRB_LS AND VDDRB_HS LEDS</p> <p style="margin: 5px 0 0 20px;">SHEET 07: VDDRC_LS AND VDDRC_HS LEDS</p> <p style="margin: 5px 0 0 20px;">SHEET 08: VDDRD_LS AND VDDRD_HS LEDS</p> <p style="margin: 5px 0 0 20px;">SHEET 09: 1P0V_A1, 1P0V_A2, 5V LEDS</p> <p style="margin: 5px 0 0 20px;">SHEET 10: EDGE CONNECTOR AND DECOUPLING</p> </div>	<table border="1" style="width: 100%; border-collapse: collapse;"> <tr> <td colspan="4" style="text-align: center;"> TEXAS INSTRUMENTS</td> </tr> <tr> <td colspan="4" style="font-size: small;">SCHEMATIC TITLE</td> </tr> <tr> <td colspan="4" style="text-align: center;">TLK10034 VOLTAGE MONITOR BOARD</td> </tr> <tr> <td colspan="4" style="font-size: small;">PAGE TITLE</td> </tr> <tr> <td colspan="4" style="font-size: small;">COVER PAGE AND NOTES</td> </tr> <tr> <td style="font-size: x-small;">SIZE</td> <td style="font-size: x-small;">DOCUMENT NUMBER</td> <td style="font-size: x-small;">REV</td> <td style="font-size: x-small;">SHEET</td> </tr> <tr> <td style="text-align: center;">B</td> <td style="text-align: center;">6542127</td> <td style="text-align: center;">NA</td> <td style="text-align: center;">1 of 10</td> </tr> </table>	 TEXAS INSTRUMENTS				SCHEMATIC TITLE				TLK10034 VOLTAGE MONITOR BOARD				PAGE TITLE				COVER PAGE AND NOTES				SIZE	DOCUMENT NUMBER	REV	SHEET	B	6542127	NA	1 of 10
 TEXAS INSTRUMENTS																														
SCHEMATIC TITLE																														
TLK10034 VOLTAGE MONITOR BOARD																														
PAGE TITLE																														
COVER PAGE AND NOTES																														
SIZE	DOCUMENT NUMBER	REV	SHEET																											
B	6542127	NA	1 of 10																											

Figure 44. TLK10034 EVM Voltage Monitor Board Schematic, Sheet 1 Cover Page and Index

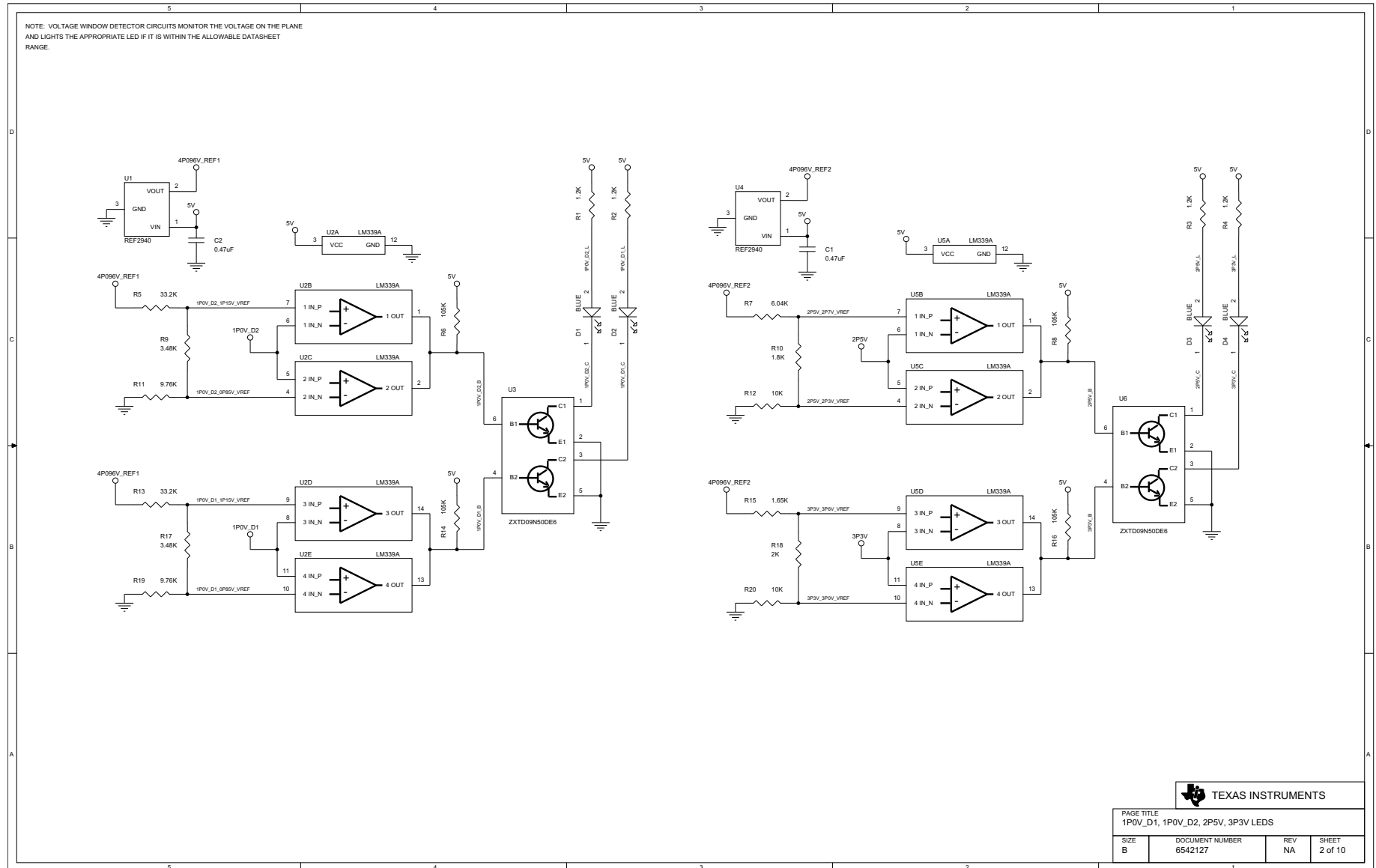

Figure 45. TLK10034 EVM Voltage Monitor Board Schematic, Sheet 2 1V_D1/D2, 2p5V, 3p3V LEDs

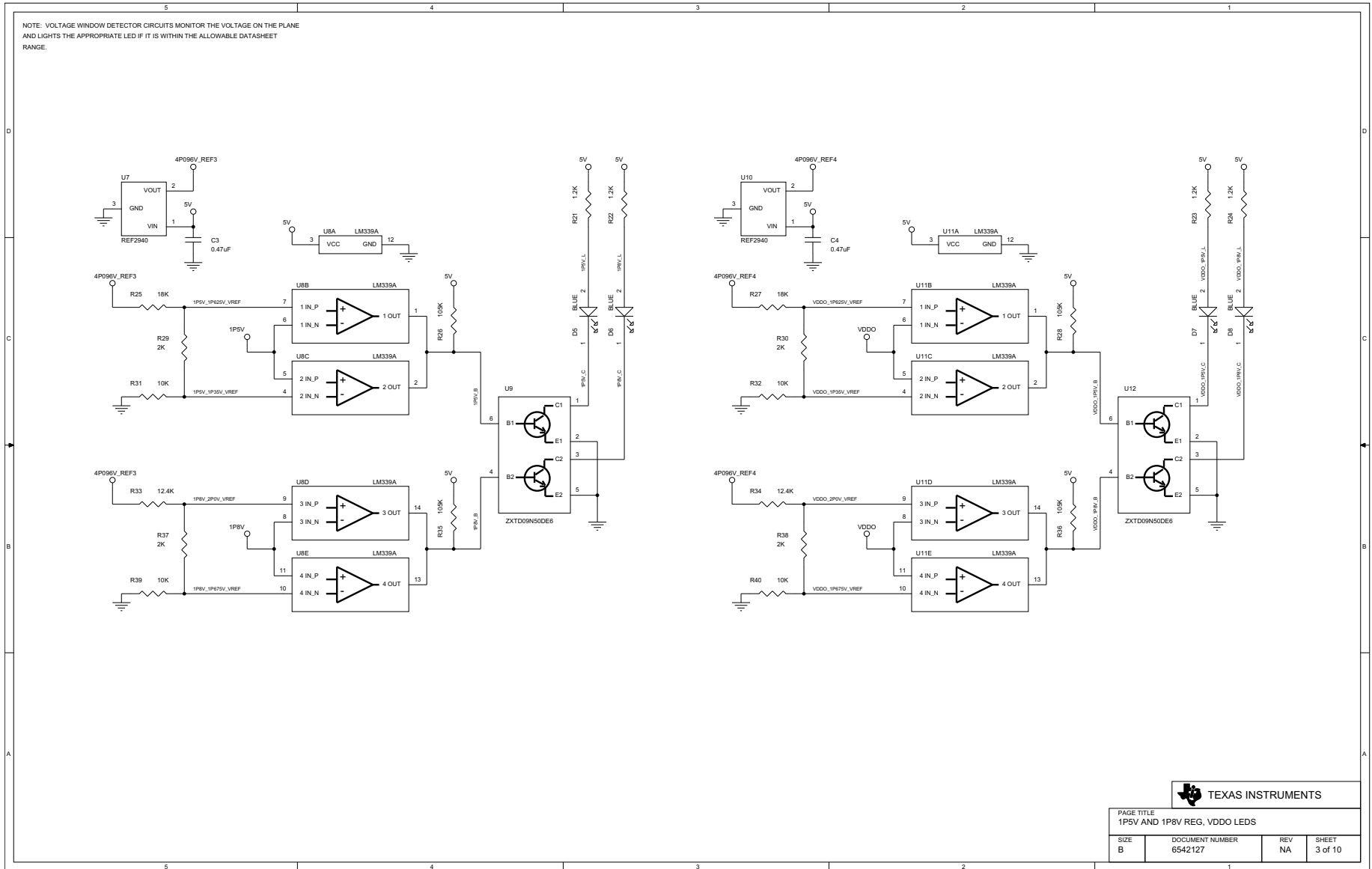

Figure 46. TLK10034 EVM Voltage Monitor Board Schematic, Sheet 3 1p5V, 1p8V, VDDO LEDs

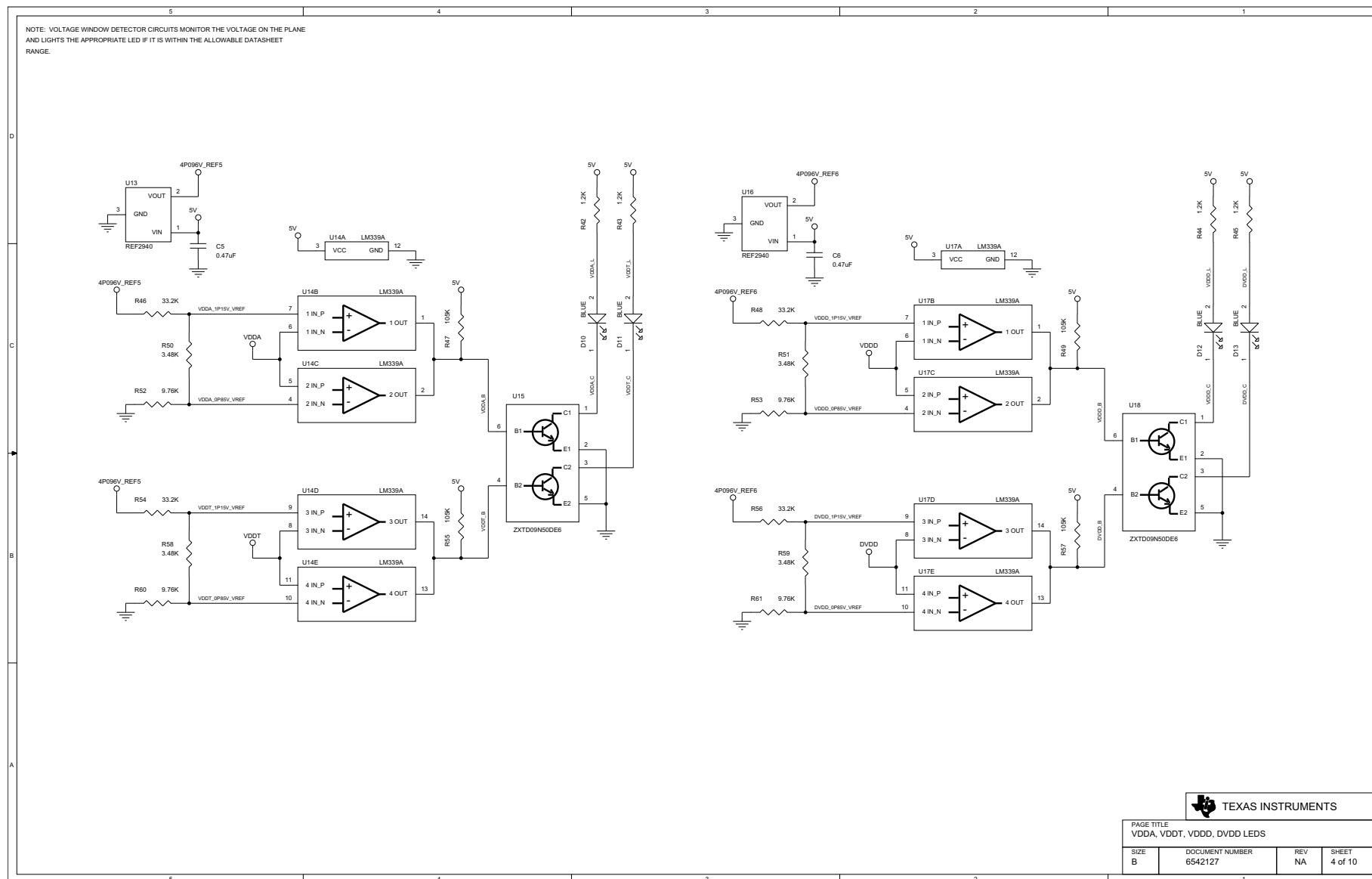

Figure 47. TLK10034 EVM Voltage Monitor Board Schematic, Sheet 4 VDDA, VDDT, VDDD, DVDD LEDs

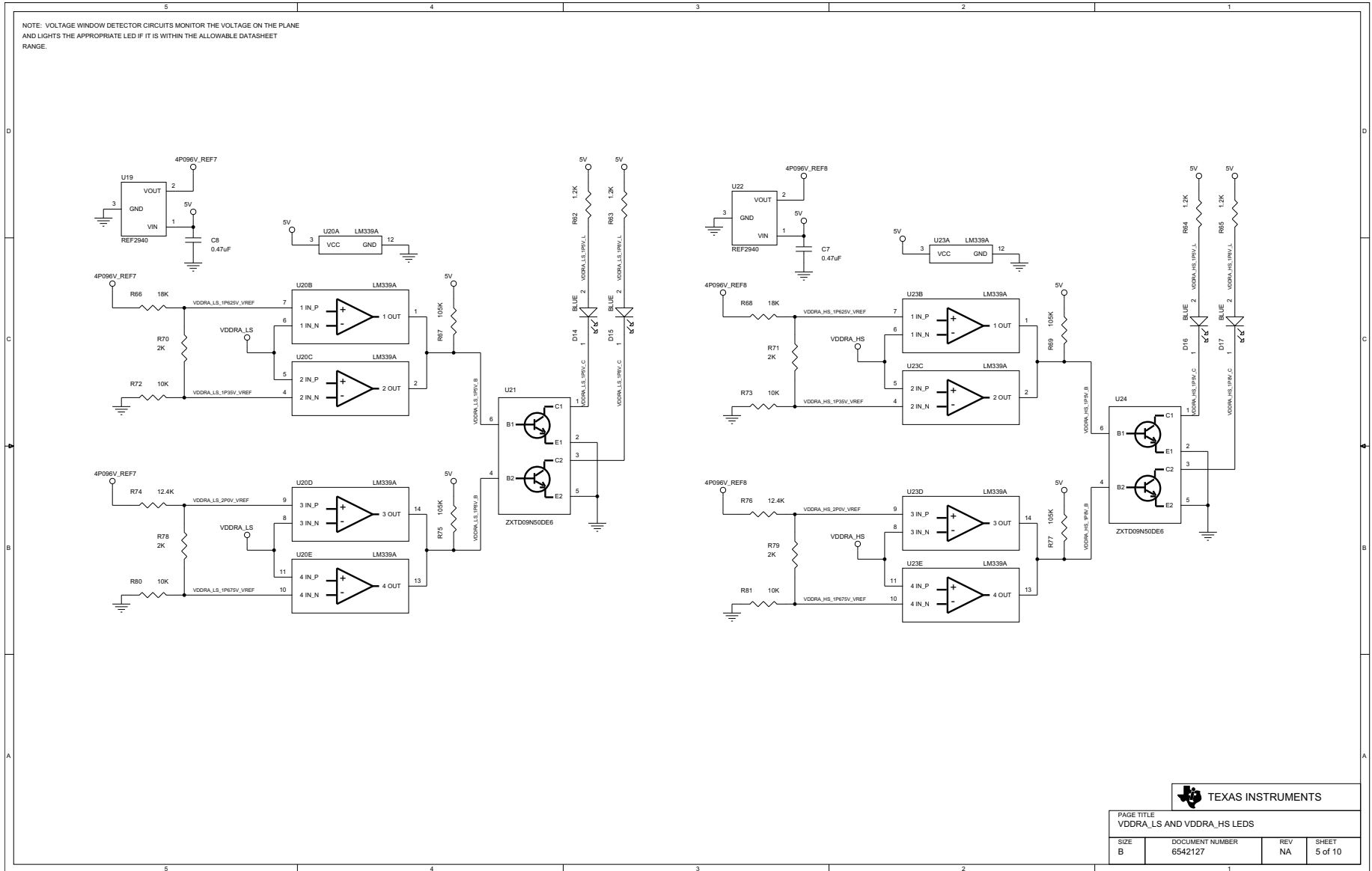

Figure 48. TLK10034 EVM Voltage Monitor Board Schematic, Sheet 5 VDDRA_LS/HS LEDs

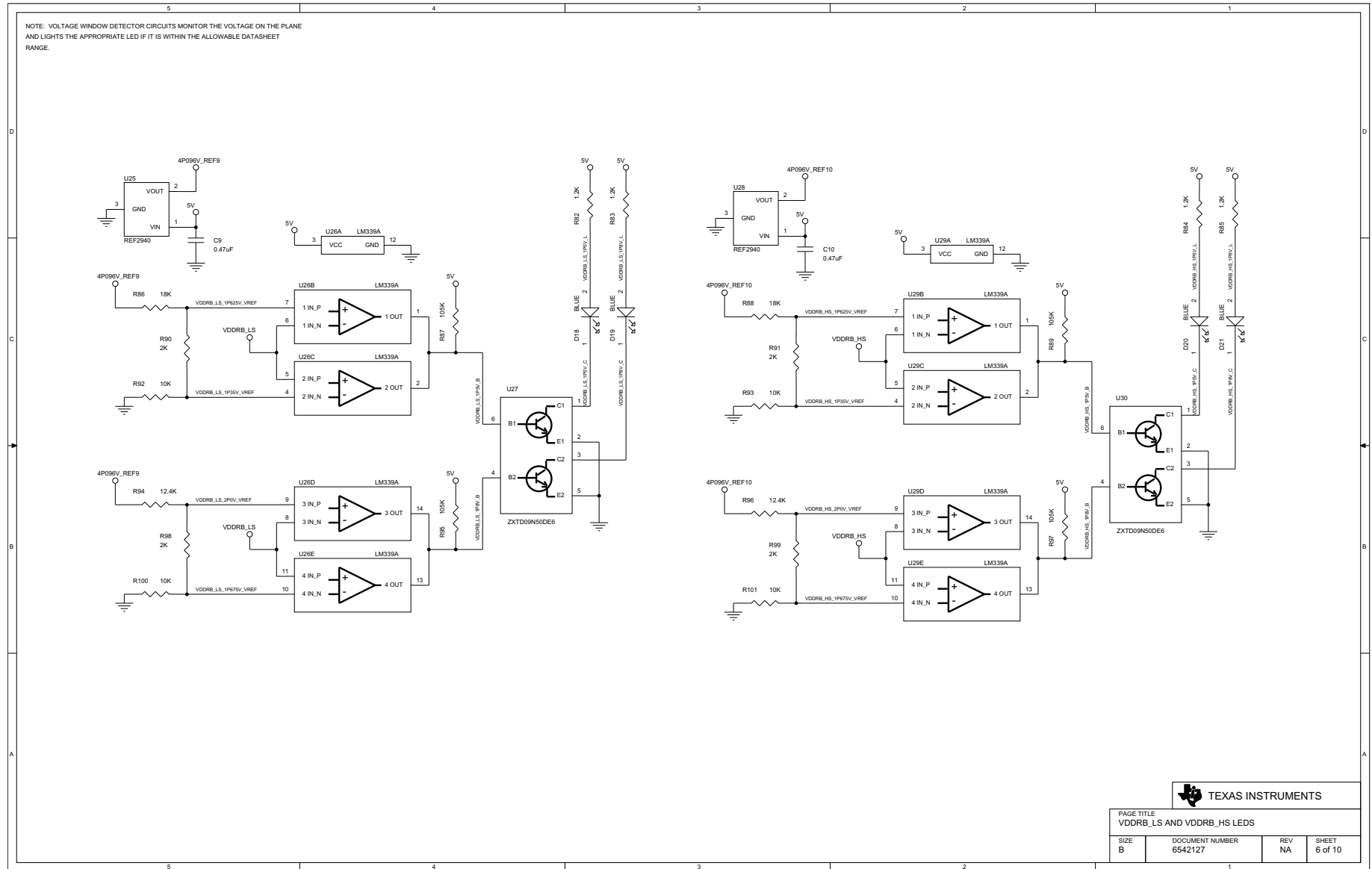

Figure 49. TLK10034 EVM Voltage Monitor Board Schematic, Sheet 6 VDDRB_LS/HS LEDs

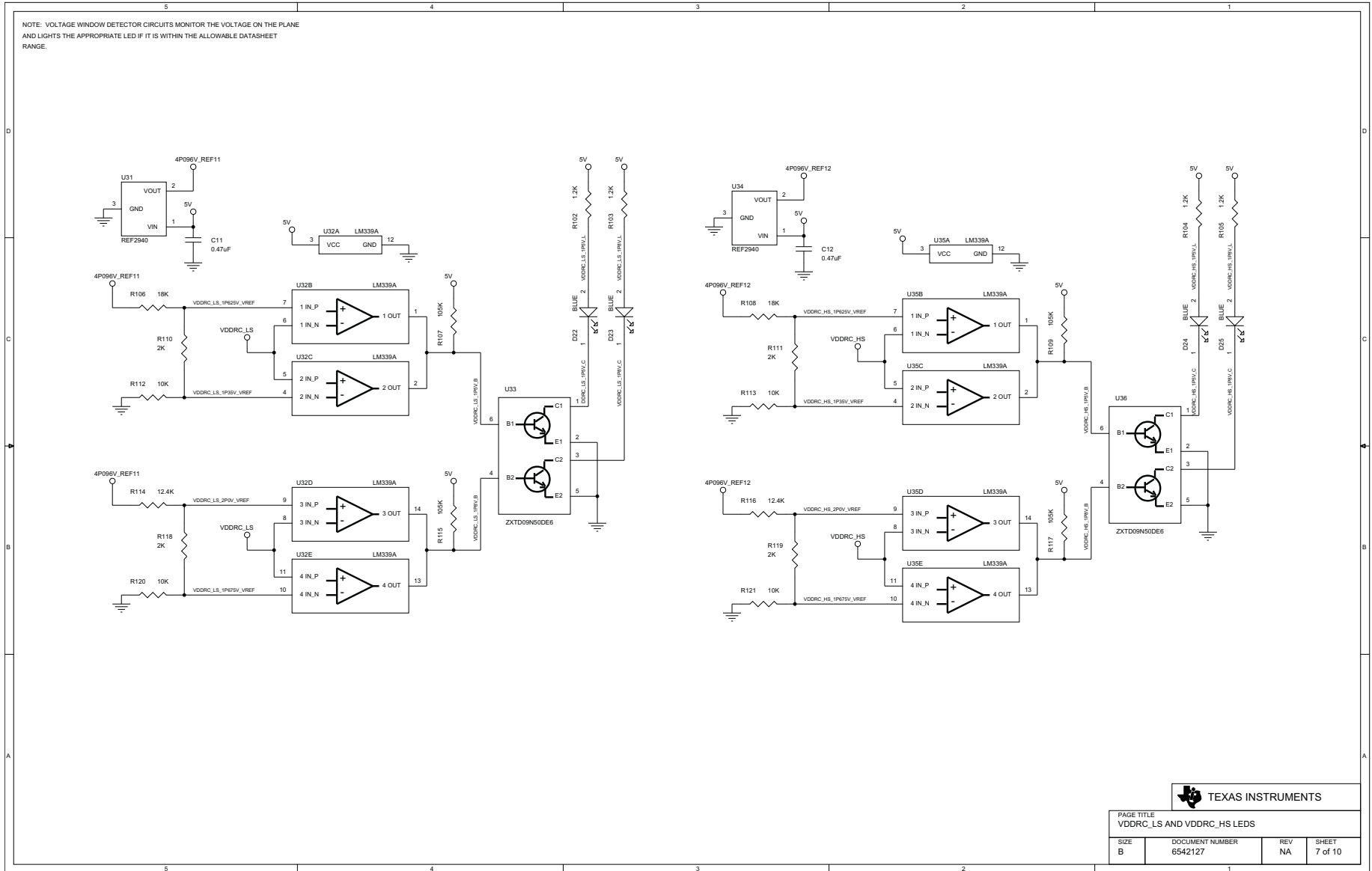

Figure 50. TLK10034 EVM Voltage Monitor Board Schematic, Sheet 7 VDDRC_LS/HS LEDs

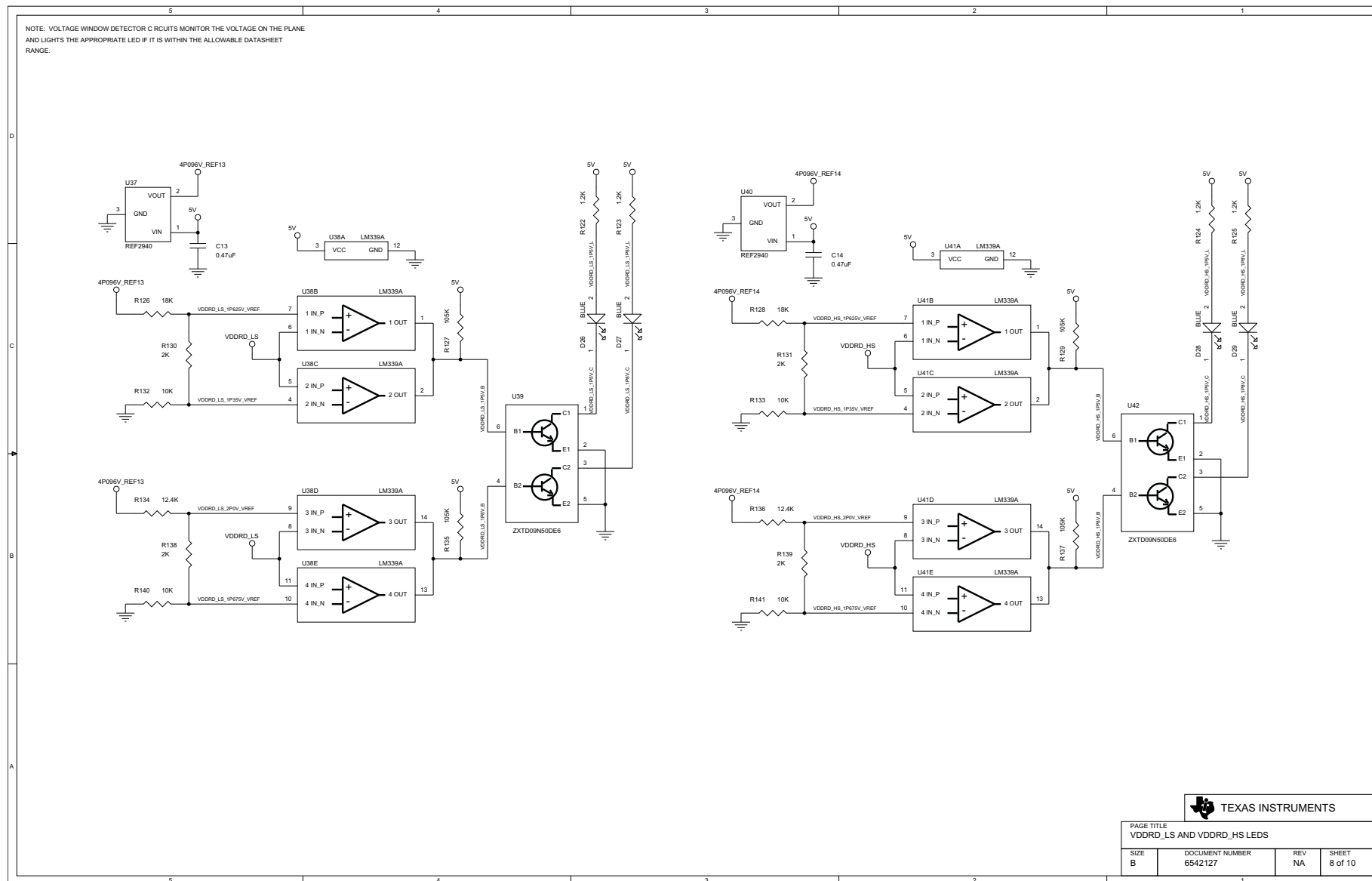

Figure 51. TLK10034 EVM Voltage Monitor Board Schematic, Sheet 8 VDDR_Ls/HS LEDs

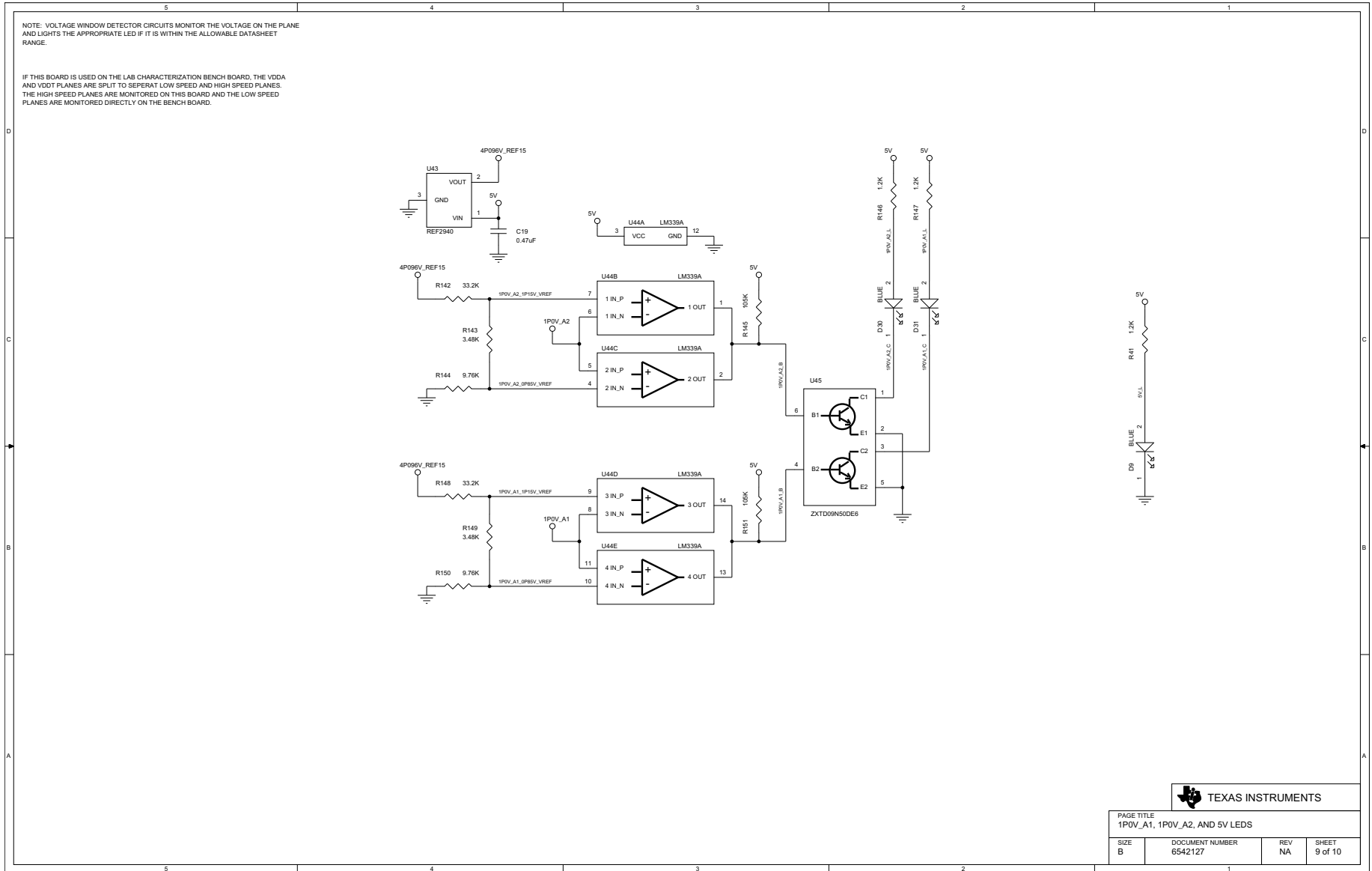

Figure 52. TLK10034 EVM Voltage Monitor Board Schematic, Sheet 9 2p5V_A/D, 5V LEDs

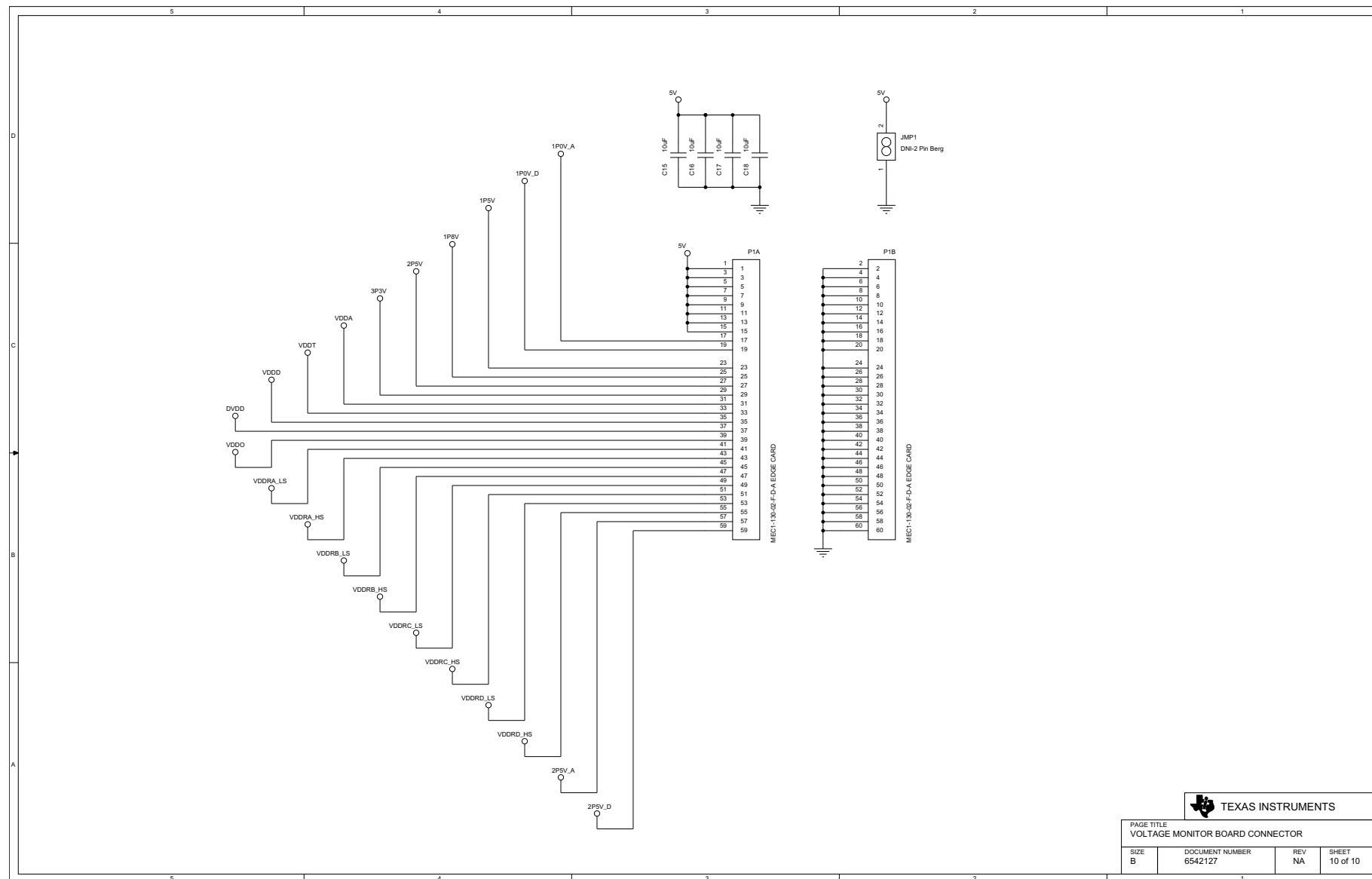

Figure 53. TLK10034 EVM Voltage Monitor Board Schematic, Sheet 10 Edge Connector

16 TLK10034 EVM Voltage Monitor Board Layout

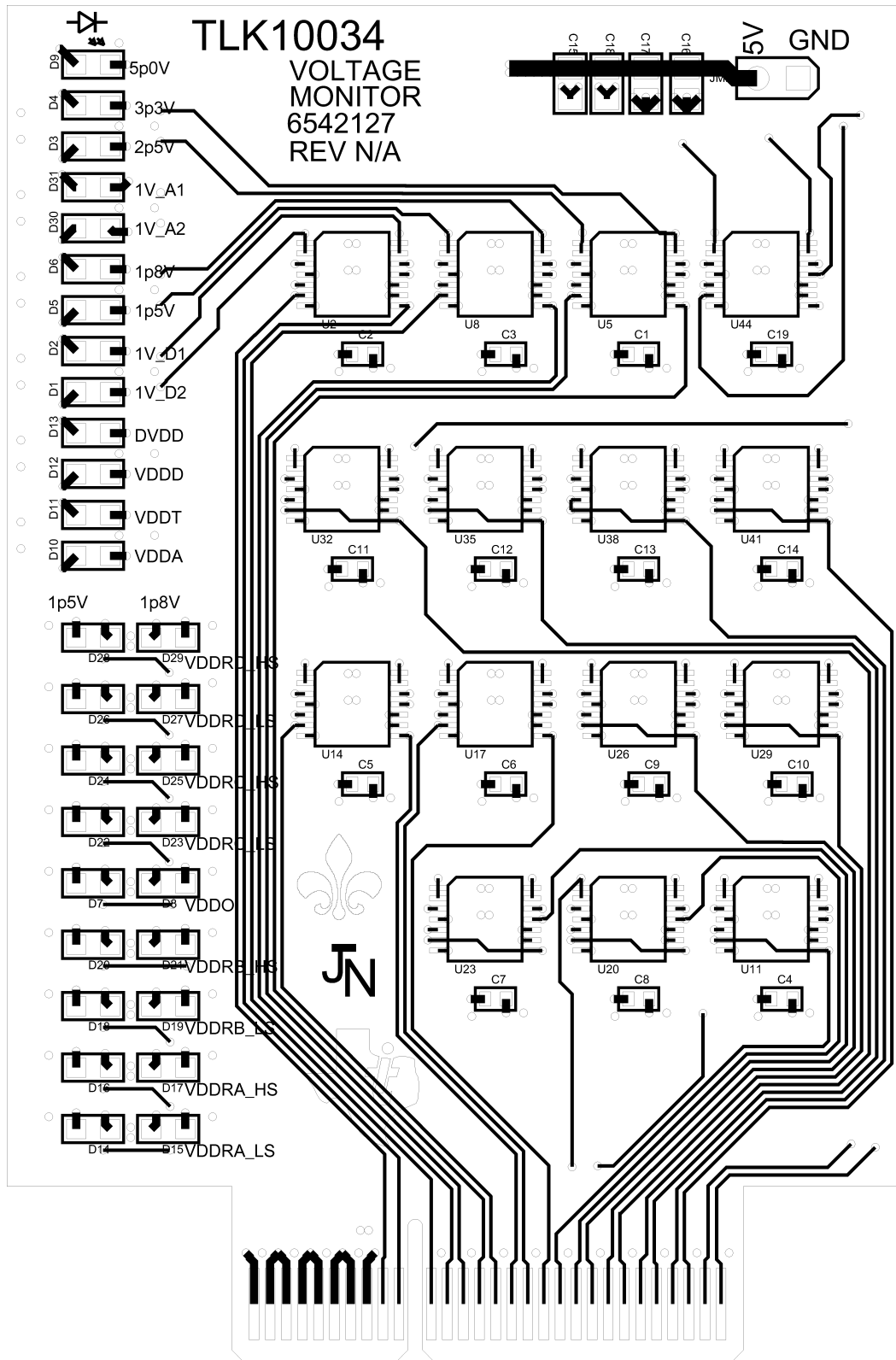

Figure 54. TLK10034 EVM Voltage Monitor Board Layout, Top Signal Layer

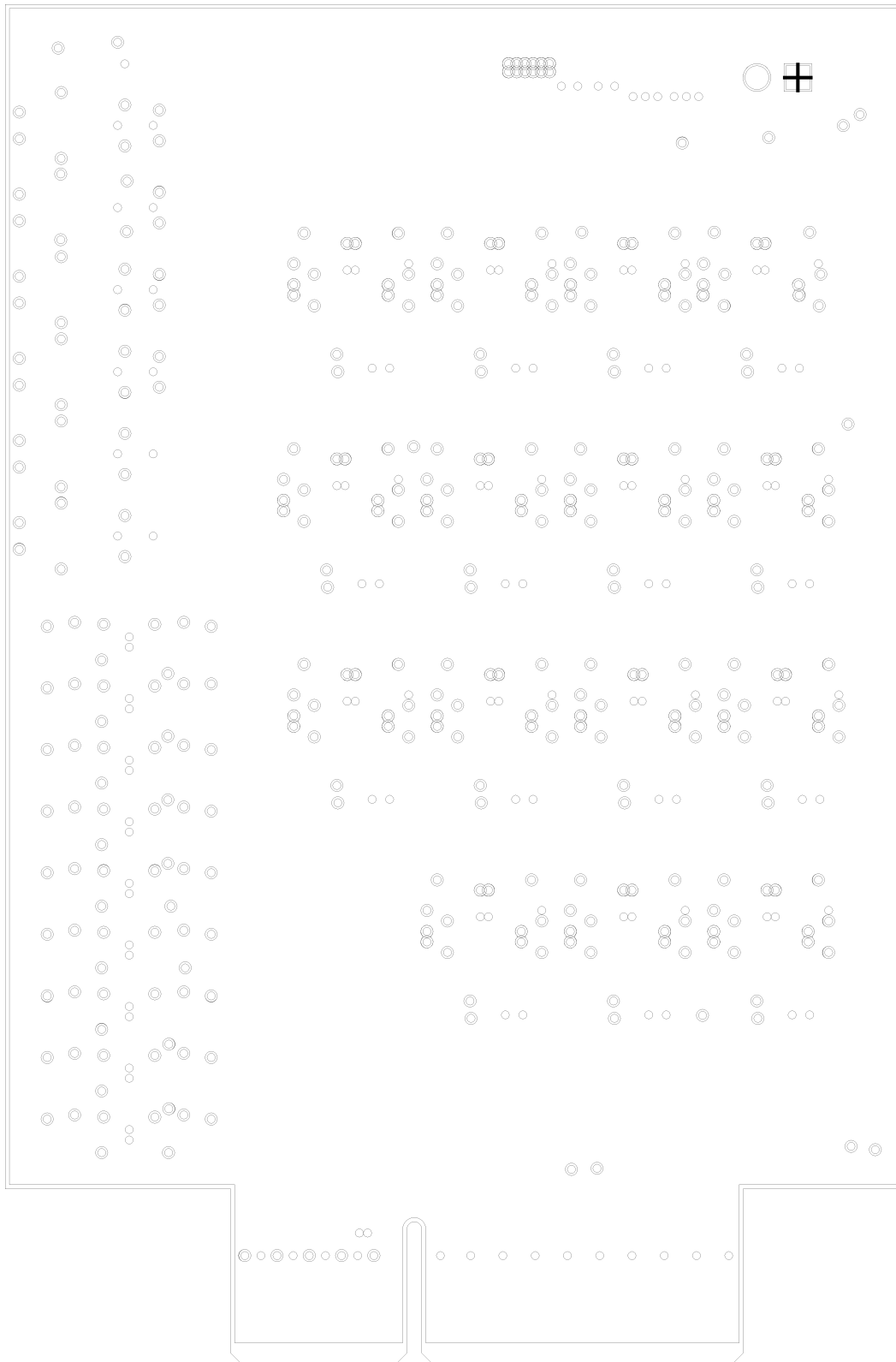

Figure 55. TLK10034 EVM Voltage Monitor Board Layout, Internal Ground (Layer 2)

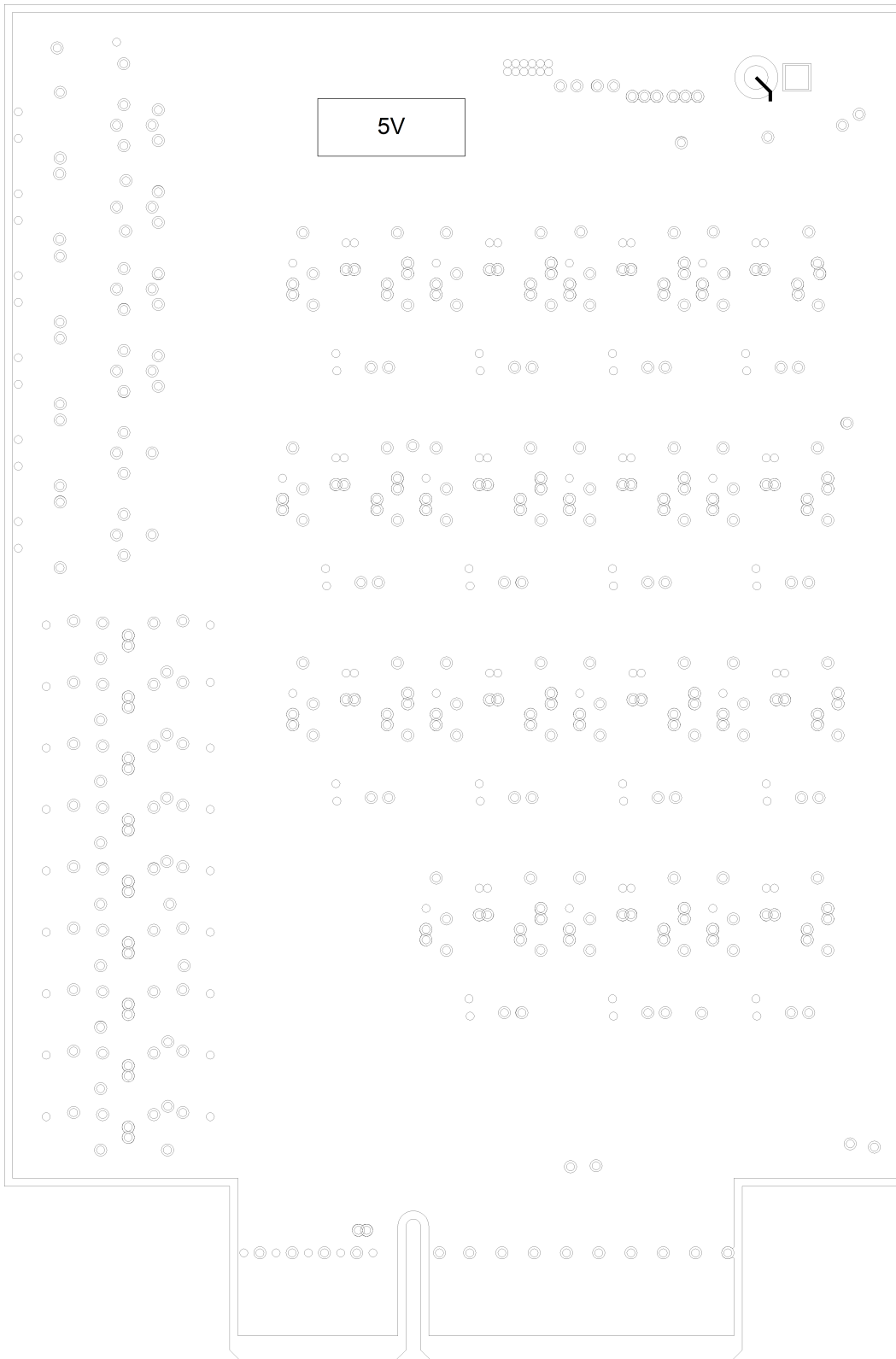

Figure 56. TLK10034 EVM Voltage Monitor Board Layout, Internal Power (Layer 3)

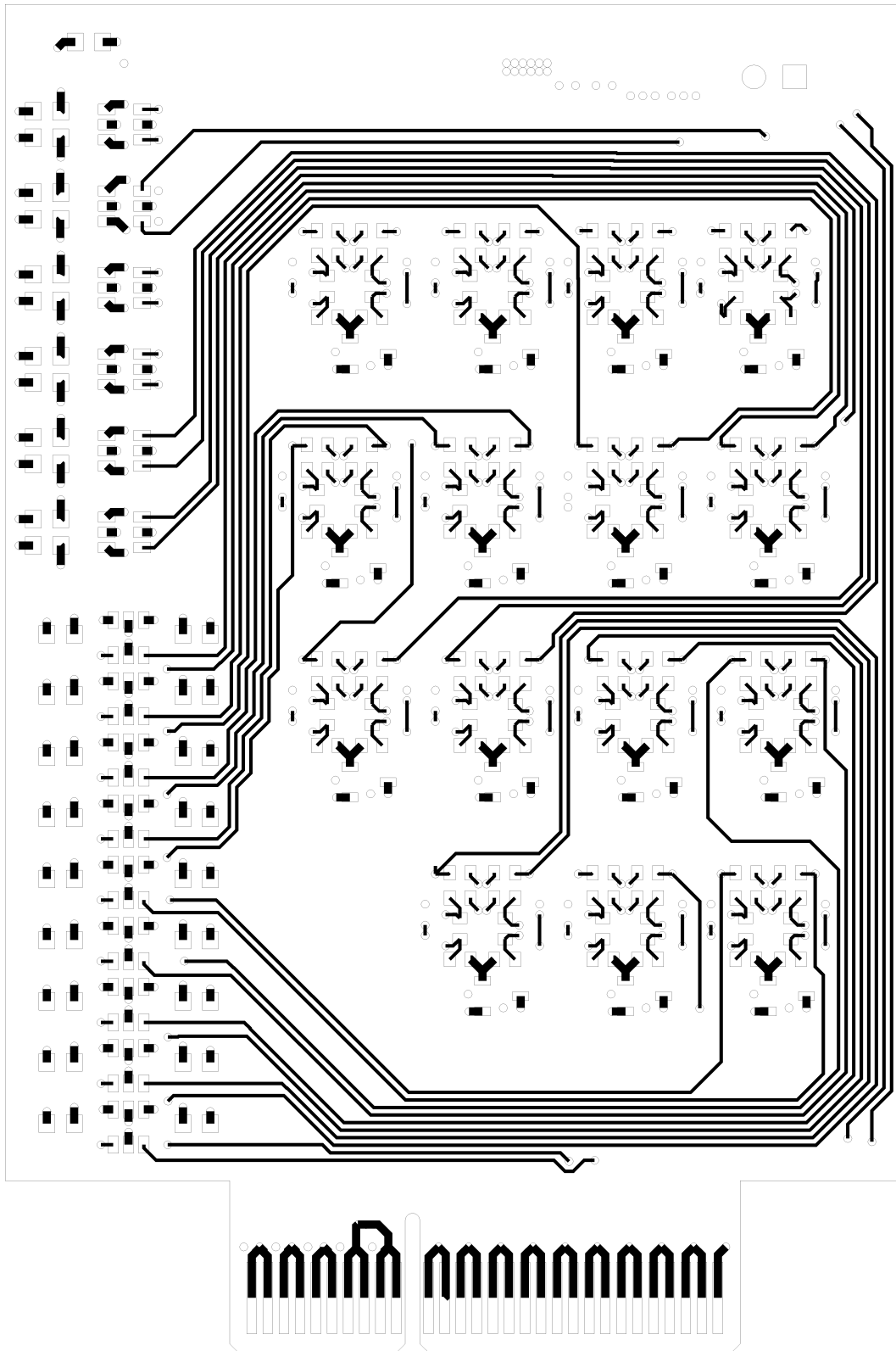

Figure 57. TLK10034 EVM Voltage Monitor Board Layout, Bottom Signal (Layer 4)

Table 3. TLK10034 EVM Voltage Monitor Board Layer Construction

Subclass Name	Type	Material	Thickness (MIL)	Dielectric Constant	Width (MIL)	Coupling Type / Spacing (MIL)
	SURFACE	AIR		1		
TOP	CONDUCTOR	COPPER	2	1	8.5 (Single)	None/None (Single)
	DIELECTRIC	FR-4	5	4.5		
L2_GND	PLANE	COPPER	1.2	1		
	DIELECTRIC	FR-4	45	4.5		
L3_PWR	PLANE	COPPER	1.2	1		
	DIELECTRIC	FR-4	5	4.5		
BOTTOM	CONDUCTOR	COPPER	2	1	8.5 (Single)	None/None (Single)
	SURFACE	AIR				

NOTE: The impedance is set at slightly less than 50 or 100 Ω on the traces to compensate for slight over-etching during the manufacturing process. The end impedance after etching should result in a 50- or 100- Ω impedance. Always consult with your board manufacturer for their process and design requirements, ensuring the desired impedance is achieved.

17 TLK10034 EVM USB Dongle Board Schematics



NOTES: 1. PLACE NET NAMES ON ALL JUMPERS AND HEADERS. 2. PLACE ALL PARTS ON A 0 OR 90 DEGREE ORIENTATION. 3. SERIAL DATA SHOULD BE ROUTED AS SINGLE-ENDED 50 OHM TRANSMISSION LINES ON OUTSIDE LAYERS. 4. USE FR4-370 MATERIAL FOR ALL LAYERS. 5. PCB MUST BE 0.062 IN THICK 6. MATES WITH SAMTEC CONNECTOR (MEC1-120-02-F-D-A)	<div style="border: 1px solid black; padding: 10px; width: fit-content; margin: auto;"> <p>SCHEMATIC SHEET INDEX:</p> <p>SHEET 01: CIF USB DONGLE COVER SHEET AND NOTES SHEET 02: SCHEMATIC</p> </div>	<table border="1" style="width: 100%; border-collapse: collapse;"> <tr> <td colspan="4" style="text-align: center;"> TEXAS INSTRUMENTS</td> </tr> <tr> <td colspan="4">SCHEMATIC TITLE</td> </tr> <tr> <td colspan="4">CIF USB DONGLE</td> </tr> <tr> <td colspan="4">PAGE TITLE</td> </tr> <tr> <td colspan="4">COVER PAGE AND NOTES</td> </tr> <tr> <td style="font-size: small;">SIZE</td> <td style="font-size: small;">DOCUMENT NUMBER</td> <td style="font-size: small;">REV</td> <td style="font-size: small;">SHEET</td> </tr> <tr> <td style="font-size: x-small;">B</td> <td style="font-size: x-small;">6542126</td> <td style="font-size: x-small;">NA</td> <td style="font-size: x-small;">1 of 2</td> </tr> </table>	 TEXAS INSTRUMENTS				SCHEMATIC TITLE				CIF USB DONGLE				PAGE TITLE				COVER PAGE AND NOTES				SIZE	DOCUMENT NUMBER	REV	SHEET	B	6542126	NA	1 of 2
 TEXAS INSTRUMENTS																														
SCHEMATIC TITLE																														
CIF USB DONGLE																														
PAGE TITLE																														
COVER PAGE AND NOTES																														
SIZE	DOCUMENT NUMBER	REV	SHEET																											
B	6542126	NA	1 of 2																											

Figure 58. TLK10034 EVM USB Dongle Board Schematic, Sheet 1 Cover Page and Index

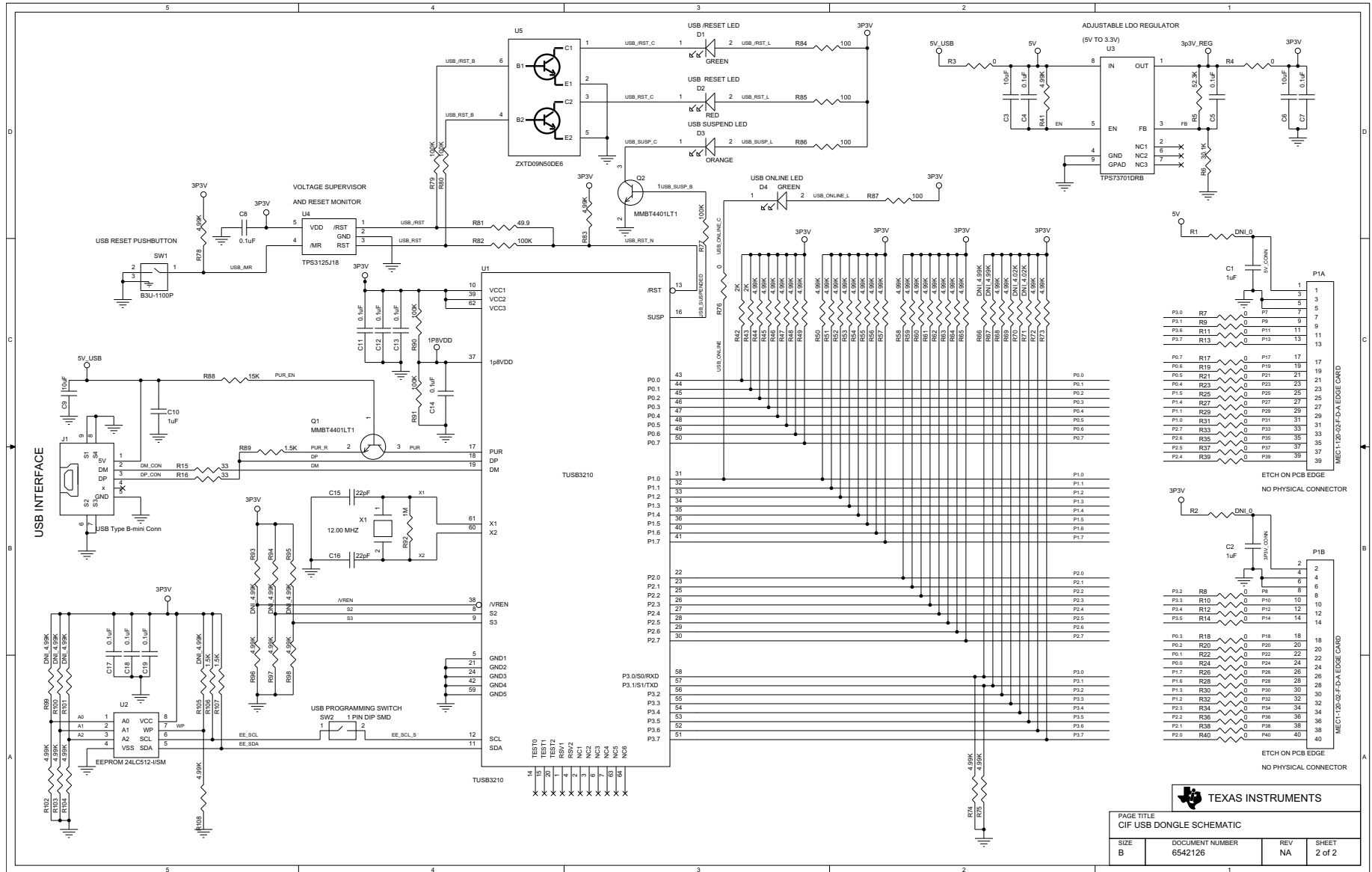

Figure 59. TLK10034 EVM USB Dongle Board Schematic, Sheet 2 Schematics

18 TLK10034 EVM USB Dongle Board Layout

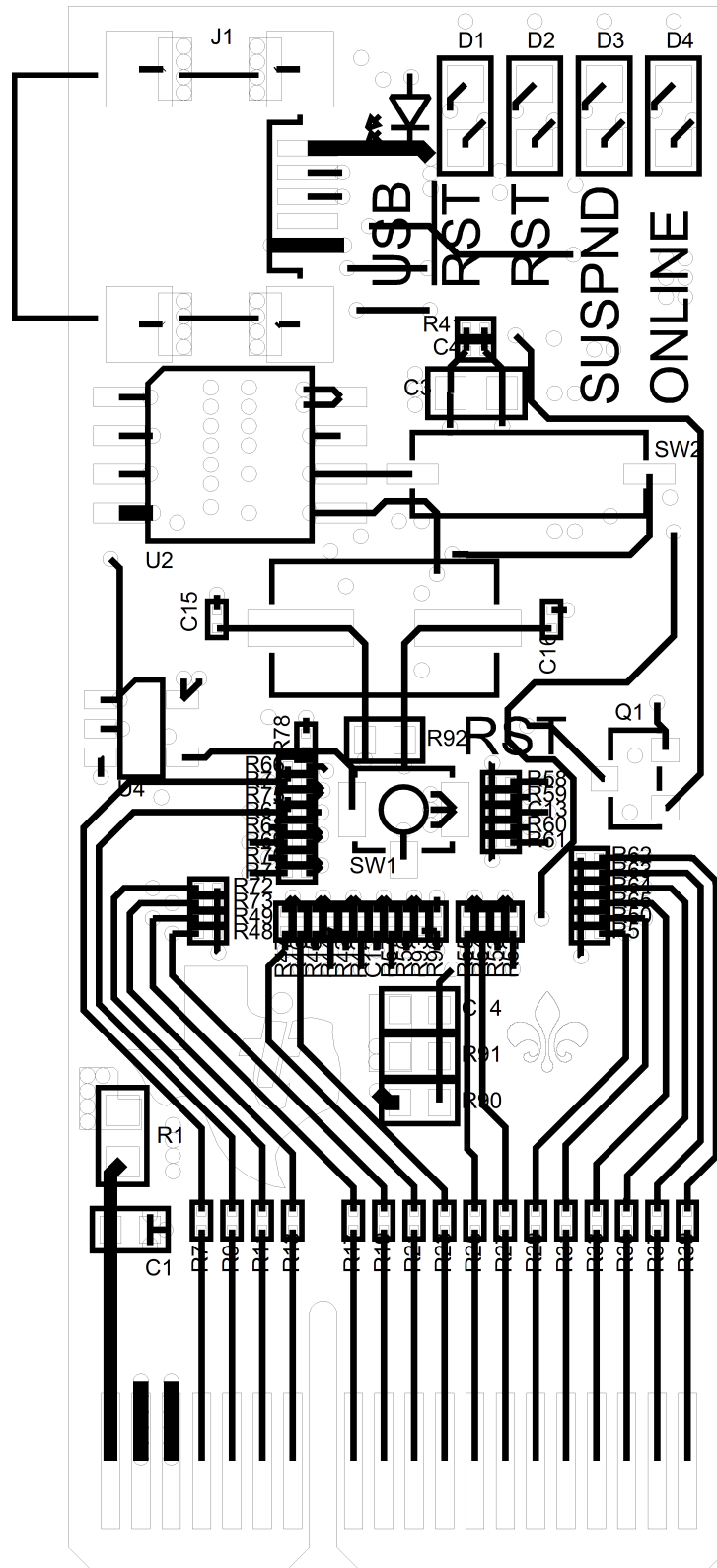

Figure 60. TLK10034 EVM USB Dongle Board Layout, Top Signal Layer

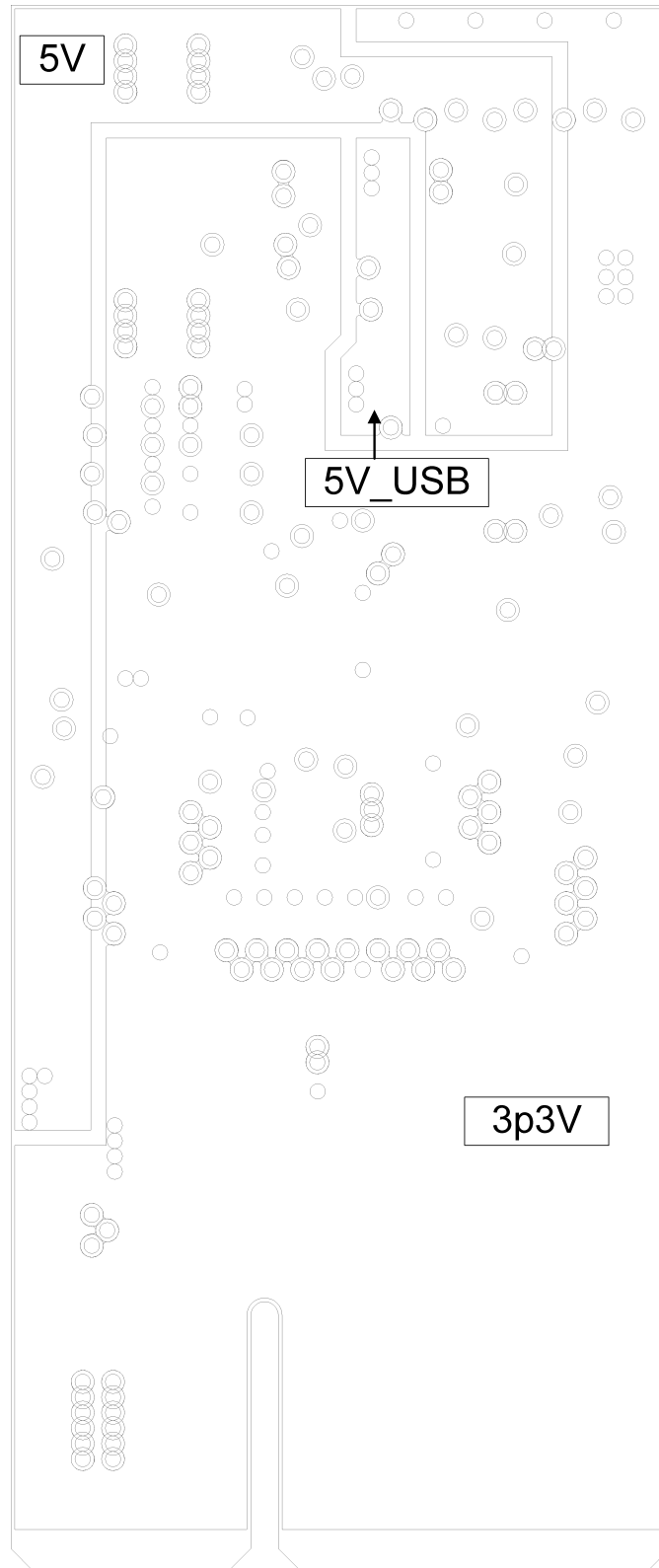

Figure 61. TLK10034 EVM USB Dongle Board Layout, Internal Power (Layer 2)

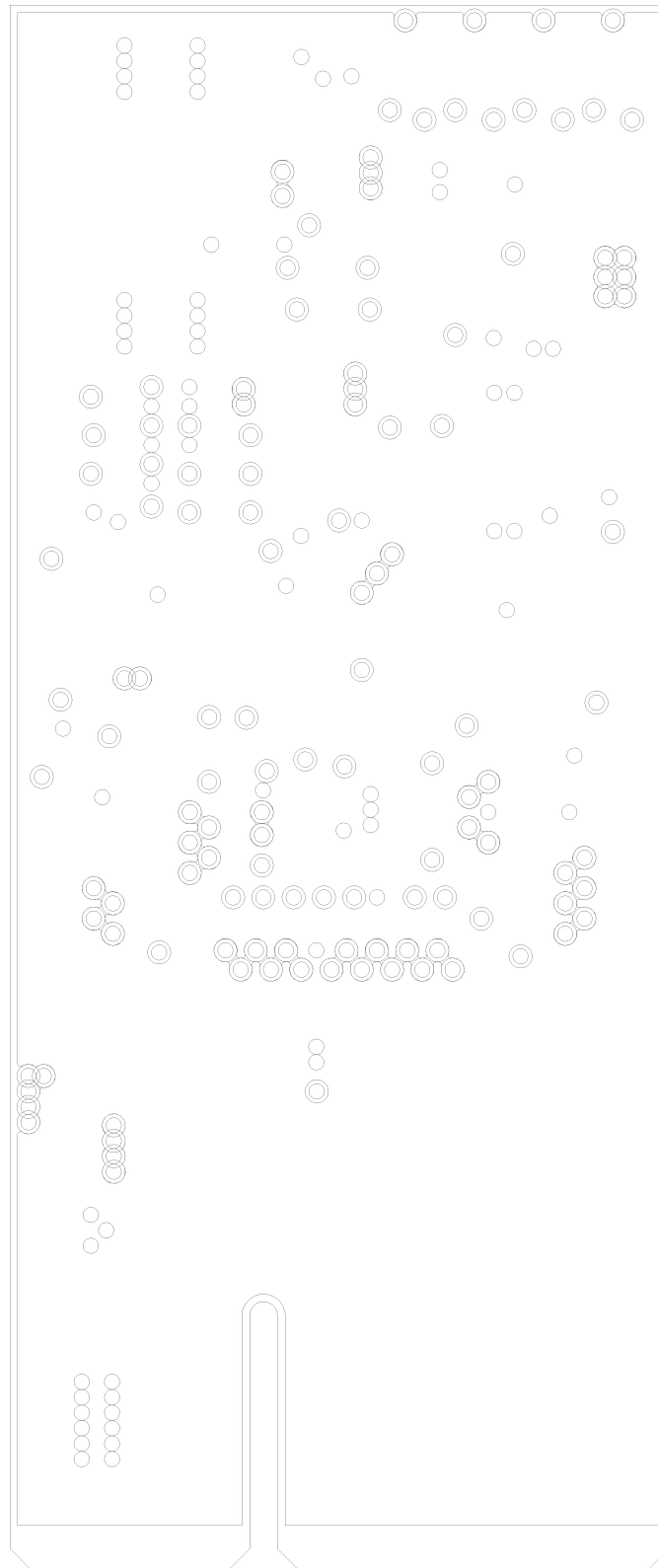

Figure 62. TLK10034 EVM USB Dongle Board Layout, Internal GND (Layer 3)

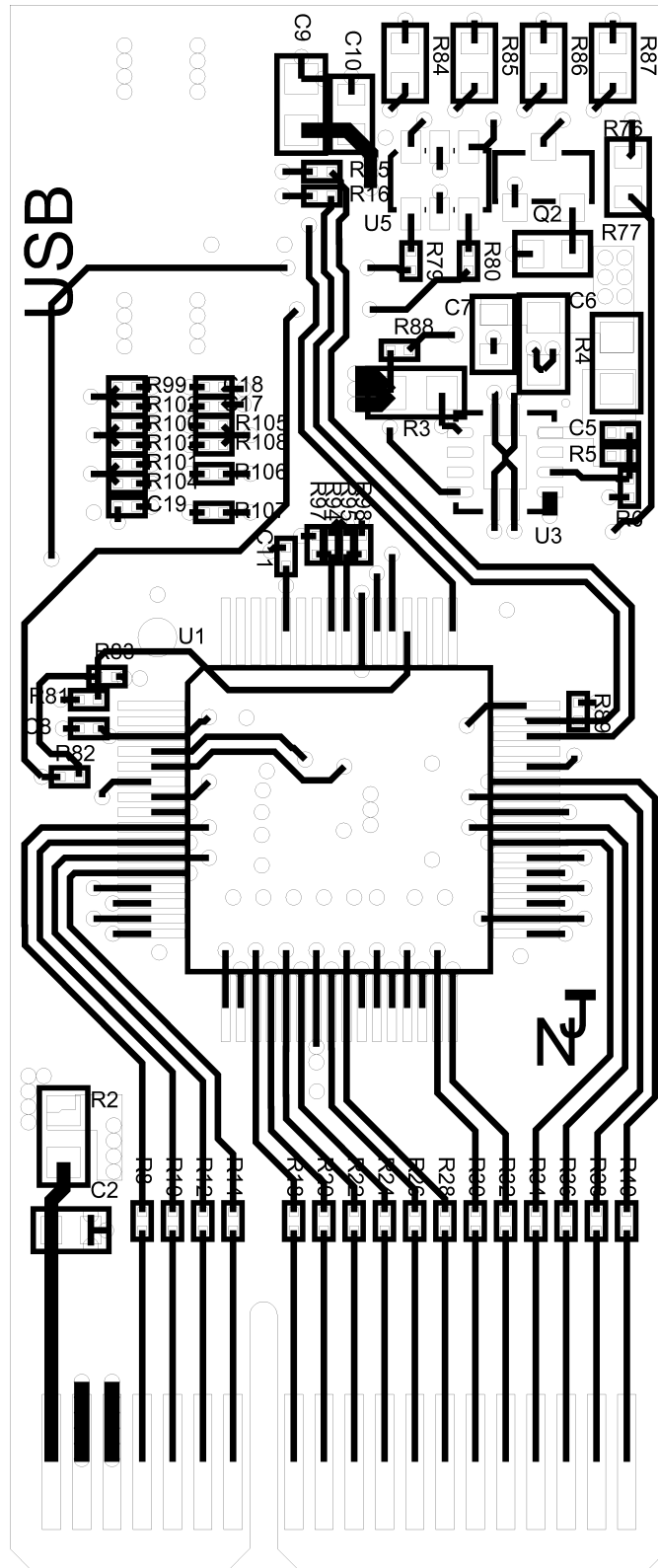

Figure 63. TLK10034 EVM USB Dongle Board Layout, Bottom Signal (Layer 4 Top View)

Table 4. TLK10034 EVM USB Dongle Board Layer Construction

Subclass Name	Type	Material	Thickness (MIL)	Dielectric Constant	Width (MIL)	Coupling Type / Spacing (MIL)
	SURFACE	AIR		1		
TOP	CONDUCTOR	COPPER	2	1	8.5 (Single)	None/None (Single)
	DIELECTRIC	FR-4	5	4.5		
L2_GND	PLANE	COPPER	1.2	1		
	DIELECTRIC	FR-4	45	4.5		
L3_PWR	PLANE	COPPER	1.2	1		
	DIELECTRIC	FR-4	5	4.5		
BOTTOM	CONDUCTOR	COPPER	2	1	8.5 (Single)	None/None (Single)
	SURFACE	AIR				

NOTE: The impedance is set at slightly less than 50 or 100 Ω on the traces to compensate for slight over-etching during the manufacturing process. The end impedance after etching should result in a 50- or 100- Ω impedance. Always consult with your board manufacturer for their process and design requirements, ensuring the desired impedance is achieved.

EVALUATION BOARD/KIT/MODULE (EVM) ADDITIONAL TERMS

Texas Instruments (TI) provides the enclosed Evaluation Board/Kit/Module (EVM) under the following conditions:

The user assumes all responsibility and liability for proper and safe handling of the goods. Further, the user indemnifies TI from all claims arising from the handling or use of the goods.

Should this evaluation board/kit not meet the specifications indicated in the User's Guide, the board/kit may be returned within 30 days from the date of delivery for a full refund. THE FOREGOING LIMITED WARRANTY IS THE EXCLUSIVE WARRANTY MADE BY SELLER TO BUYER AND IS IN LIEU OF ALL OTHER WARRANTIES, EXPRESSED, IMPLIED, OR STATUTORY, INCLUDING ANY WARRANTY OF MERCHANTABILITY OR FITNESS FOR ANY PARTICULAR PURPOSE. EXCEPT TO THE EXTENT OF THE INDEMNITY SET FORTH ABOVE, NEITHER PARTY SHALL BE LIABLE TO THE OTHER FOR ANY INDIRECT, SPECIAL, INCIDENTAL, OR CONSEQUENTIAL DAMAGES.

Please read the User's Guide and, specifically, the Warnings and Restrictions notice in the User's Guide prior to handling the product. This notice contains important safety information about temperatures and voltages. For additional information on TI's environmental and/or safety programs, please visit www.ti.com/esh or contact TI.

No license is granted under any patent right or other intellectual property right of TI covering or relating to any machine, process, or combination in which such TI products or services might be or are used. TI currently deals with a variety of customers for products, and therefore our arrangement with the user is not exclusive. TI assumes no liability for applications assistance, customer product design, software performance, or infringement of patents or services described herein.

REGULATORY COMPLIANCE INFORMATION

As noted in the EVM User's Guide and/or EVM itself, this EVM and/or accompanying hardware may or may not be subject to the Federal Communications Commission (FCC) and Industry Canada (IC) rules.

For EVMs **not** subject to the above rules, this evaluation board/kit/module is intended for use for ENGINEERING DEVELOPMENT, DEMONSTRATION OR EVALUATION PURPOSES ONLY and is not considered by TI to be a finished end product fit for general consumer use. It generates, uses, and can radiate radio frequency energy and has not been tested for compliance with the limits of computing devices pursuant to part 15 of FCC or ICES-003 rules, which are designed to provide reasonable protection against radio frequency interference. Operation of the equipment may cause interference with radio communications, in which case the user at his own expense will be required to take whatever measures may be required to correct this interference.

General Statement for EVMs including a radio

User Power/Frequency Use Obligations: This radio is intended for development/professional use only in legally allocated frequency and power limits. Any use of radio frequencies and/or power availability of this EVM and its development application(s) must comply with local laws governing radio spectrum allocation and power limits for this evaluation module. It is the user's sole responsibility to only operate this radio in legally acceptable frequency space and within legally mandated power limitations. Any exceptions to this are strictly prohibited and unauthorized by Texas Instruments unless user has obtained appropriate experimental/development licenses from local regulatory authorities, which is responsibility of user including its acceptable authorization.

For EVMs annotated as FCC – FEDERAL COMMUNICATIONS COMMISSION Part 15 Compliant

Caution

This device complies with part 15 of the FCC Rules. Operation is subject to the following two conditions: (1) This device may not cause harmful interference, and (2) this device must accept any interference received, including interference that may cause undesired operation.

Changes or modifications not expressly approved by the party responsible for compliance could void the user's authority to operate the equipment.

FCC Interference Statement for Class A EVM devices

This equipment has been tested and found to comply with the limits for a Class A digital device, pursuant to part 15 of the FCC Rules. These limits are designed to provide reasonable protection against harmful interference when the equipment is operated in a commercial environment. This equipment generates, uses, and can radiate radio frequency energy and, if not installed and used in accordance with the instruction manual, may cause harmful interference to radio communications. Operation of this equipment in a residential area is likely to cause harmful interference in which case the user will be required to correct the interference at his own expense.

FCC Interference Statement for Class B EVM devices

This equipment has been tested and found to comply with the limits for a Class B digital device, pursuant to part 15 of the FCC Rules. These limits are designed to provide reasonable protection against harmful interference in a residential installation. This equipment generates, uses and can radiate radio frequency energy and, if not installed and used in accordance with the instructions, may cause harmful interference to radio communications. However, there is no guarantee that interference will not occur in a particular installation. If this equipment does cause harmful interference to radio or television reception, which can be determined by turning the equipment off and on, the user is encouraged to try to correct the interference by one or more of the following measures:

- Reorient or relocate the receiving antenna.
- Increase the separation between the equipment and receiver.
- Connect the equipment into an outlet on a circuit different from that to which the receiver is connected.
- Consult the dealer or an experienced radio/TV technician for help.

For EVMs annotated as IC – INDUSTRY CANADA Compliant

This Class A or B digital apparatus complies with Canadian ICES-003.

Changes or modifications not expressly approved by the party responsible for compliance could void the user's authority to operate the equipment.

Concerning EVMs including radio transmitters

This device complies with Industry Canada licence-exempt RSS standard(s). Operation is subject to the following two conditions: (1) this device may not cause interference, and (2) this device must accept any interference, including interference that may cause undesired operation of the device.

Concerning EVMs including detachable antennas

Under Industry Canada regulations, this radio transmitter may only operate using an antenna of a type and maximum (or lesser) gain approved for the transmitter by Industry Canada. To reduce potential radio interference to other users, the antenna type and its gain should be so chosen that the equivalent isotropically radiated power (e.i.r.p.) is not more than that necessary for successful communication.

This radio transmitter has been approved by Industry Canada to operate with the antenna types listed in the user guide with the maximum permissible gain and required antenna impedance for each antenna type indicated. Antenna types not included in this list, having a gain greater than the maximum gain indicated for that type, are strictly prohibited for use with this device.

Cet appareil numérique de la classe A ou B est conforme à la norme NMB-003 du Canada.

Les changements ou les modifications pas expressément approuvés par la partie responsable de la conformité ont pu vider l'autorité de l'utilisateur pour actionner l'équipement.

Concernant les EVMs avec appareils radio

Le présent appareil est conforme aux CNR d'Industrie Canada applicables aux appareils radio exempts de licence. L'exploitation est autorisée aux deux conditions suivantes : (1) l'appareil ne doit pas produire de brouillage, et (2) l'utilisateur de l'appareil doit accepter tout brouillage radioélectrique subi, même si le brouillage est susceptible d'en compromettre le fonctionnement.

Concernant les EVMs avec antennes détachables

Conformément à la réglementation d'Industrie Canada, le présent émetteur radio peut fonctionner avec une antenne d'un type et d'un gain maximal (ou inférieur) approuvé pour l'émetteur par Industrie Canada. Dans le but de réduire les risques de brouillage radioélectrique à l'intention des autres utilisateurs, il faut choisir le type d'antenne et son gain de sorte que la puissance isotrope rayonnée équivalente (p.i.r.e.) ne dépasse pas l'intensité nécessaire à l'établissement d'une communication satisfaisante.

Le présent émetteur radio a été approuvé par Industrie Canada pour fonctionner avec les types d'antenne énumérés dans le manuel d'usage et ayant un gain admissible maximal et l'impédance requise pour chaque type d'antenne. Les types d'antenne non inclus dans cette liste, ou dont le gain est supérieur au gain maximal indiqué, sont strictement interdits pour l'exploitation de l'émetteur.

【Important Notice for Users of this Product in Japan】

This development kit is NOT certified as Confirming to Technical Regulations of Radio Law of Japan

If you use this product in Japan, you are required by Radio Law of Japan to follow the instructions below with respect to this product:

1. Use this product in a shielded room or any other test facility as defined in the notification #173 issued by Ministry of Internal Affairs and Communications on March 28, 2006, based on Sub-section 1.1 of Article 6 of the Ministry's Rule for Enforcement of Radio Law of Japan,
2. Use this product only after you obtained the license of Test Radio Station as provided in Radio Law of Japan with respect to this product, or
3. Use of this product only after you obtained the Technical Regulations Conformity Certification as provided in Radio Law of Japan with respect to this product. Also, please do not transfer this product, unless you give the same notice above to the transferee. Please note that if you could not follow the instructions above, you will be subject to penalties of Radio Law of Japan.

Texas Instruments Japan Limited
(address) 24-1, Nishi-Shinjuku 6 chome, Shinjuku-ku, Tokyo, Japan

<http://www.tij.co.jp>

【ご使用にあたっての注】

本開発キットは技術基準適合証明を受けておりません。

本製品のご使用に際しては、電波法遵守のため、以下のいずれかの措置を取っていただく必要がありますのでご注意ください。

1. 電波法施行規則第6条第1項第1号に基づく平成18年3月28日総務省告示第173号で定められた電波暗室等の試験設備でご使用いただく。
2. 実験局の免許を取得後ご使用いただく。
3. 技術基準適合証明を取得後ご使用いただく。

なお、本製品は、上記の「ご使用にあたっての注意」を譲渡先、移転先に通知しない限り、譲渡、移転できないものとします。

上記を遵守頂けない場合は、電波法の罰則が適用される可能性があることをご留意ください。

日本テキサス・インスツルメンツ株式会社
東京都新宿区西新宿6丁目24番1号
西新宿三井ビル

<http://www.tij.co.jp>

EVALUATION BOARD/KIT/MODULE (EVM) WARNINGS, RESTRICTIONS AND DISCLAIMERS

For Feasibility Evaluation Only, in Laboratory/Development Environments. Unless otherwise indicated, this EVM is not a finished electrical equipment and not intended for consumer use. It is intended solely for use for preliminary feasibility evaluation in laboratory/development environments by technically qualified electronics experts who are familiar with the dangers and application risks associated with handling electrical mechanical components, systems and subsystems. It should not be used as all or part of a finished end product.

Your Sole Responsibility and Risk. You acknowledge, represent and agree that:

1. You have unique knowledge concerning Federal, State and local regulatory requirements (including but not limited to Food and Drug Administration regulations, if applicable) which relate to your products and which relate to your use (and/or that of your employees, affiliates, contractors or designees) of the EVM for evaluation, testing and other purposes.
2. You have full and exclusive responsibility to assure the safety and compliance of your products with all such laws and other applicable regulatory requirements, and also to assure the safety of any activities to be conducted by you and/or your employees, affiliates, contractors or designees, using the EVM. Further, you are responsible to assure that any interfaces (electronic and/or mechanical) between the EVM and any human body are designed with suitable isolation and means to safely limit accessible leakage currents to minimize the risk of electrical shock hazard.
3. You will employ reasonable safeguards to ensure that your use of the EVM will not result in any property damage, injury or death, even if the EVM should fail to perform as described or expected.
4. You will take care of proper disposal and recycling of the EVM's electronic components and packing materials.

Certain Instructions. It is important to operate this EVM within TI's recommended specifications and environmental considerations per the user guidelines. Exceeding the specified EVM ratings (including but not limited to input and output voltage, current, power, and environmental ranges) may cause property damage, personal injury or death. If there are questions concerning these ratings please contact a TI field representative prior to connecting interface electronics including input power and intended loads. Any loads applied outside of the specified output range may result in unintended and/or inaccurate operation and/or possible permanent damage to the EVM and/or interface electronics. Please consult the EVM User's Guide prior to connecting any load to the EVM output. If there is uncertainty as to the load specification, please contact a TI field representative. During normal operation, some circuit components may have case temperatures greater than 60°C as long as the input and output are maintained at a normal ambient operating temperature. These components include but are not limited to linear regulators, switching transistors, pass transistors, and current sense resistors which can be identified using the EVM schematic located in the EVM User's Guide. When placing measurement probes near these devices during normal operation, please be aware that these devices may be very warm to the touch. As with all electronic evaluation tools, only qualified personnel knowledgeable in electronic measurement and diagnostics normally found in development environments should use these EVMs.

Agreement to Defend, Indemnify and Hold Harmless. You agree to defend, indemnify and hold TI, its licensors and their representatives harmless from and against any and all claims, damages, losses, expenses, costs and liabilities (collectively, "Claims") arising out of or in connection with any use of the EVM that is not in accordance with the terms of the agreement. This obligation shall apply whether Claims arise under law of tort or contract or any other legal theory, and even if the EVM fails to perform as described or expected.

Safety-Critical or Life-Critical Applications. If you intend to evaluate the components for possible use in safety critical applications (such as life support) where a failure of the TI product would reasonably be expected to cause severe personal injury or death, such as devices which are classified as FDA Class III or similar classification, then you must specifically notify TI of such intent and enter into a separate Assurance and Indemnity Agreement.

Mailing Address: Texas Instruments, Post Office Box 655303, Dallas, Texas 75265
Copyright © 2012, Texas Instruments Incorporated

EVALUATION BOARD/KIT/MODULE (EVM) ADDITIONAL TERMS

Texas Instruments (TI) provides the enclosed Evaluation Board/Kit/Module (EVM) under the following conditions:

The user assumes all responsibility and liability for proper and safe handling of the goods. Further, the user indemnifies TI from all claims arising from the handling or use of the goods.

Should this evaluation board/kit not meet the specifications indicated in the User's Guide, the board/kit may be returned within 30 days from the date of delivery for a full refund. THE FOREGOING LIMITED WARRANTY IS THE EXCLUSIVE WARRANTY MADE BY SELLER TO BUYER AND IS IN LIEU OF ALL OTHER WARRANTIES, EXPRESSED, IMPLIED, OR STATUTORY, INCLUDING ANY WARRANTY OF MERCHANTABILITY OR FITNESS FOR ANY PARTICULAR PURPOSE. EXCEPT TO THE EXTENT OF THE INDEMNITY SET FORTH ABOVE, NEITHER PARTY SHALL BE LIABLE TO THE OTHER FOR ANY INDIRECT, SPECIAL, INCIDENTAL, OR CONSEQUENTIAL DAMAGES.

Please read the User's Guide and, specifically, the Warnings and Restrictions notice in the User's Guide prior to handling the product. This notice contains important safety information about temperatures and voltages. For additional information on TI's environmental and/or safety programs, please visit www.ti.com/esh or contact TI.

No license is granted under any patent right or other intellectual property right of TI covering or relating to any machine, process, or combination in which such TI products or services might be or are used. TI currently deals with a variety of customers for products, and therefore our arrangement with the user is not exclusive. TI assumes no liability for applications assistance, customer product design, software performance, or infringement of patents or services described herein.

REGULATORY COMPLIANCE INFORMATION

As noted in the EVM User's Guide and/or EVM itself, this EVM and/or accompanying hardware may or may not be subject to the Federal Communications Commission (FCC) and Industry Canada (IC) rules.

For EVMs **not** subject to the above rules, this evaluation board/kit/module is intended for use for ENGINEERING DEVELOPMENT, DEMONSTRATION OR EVALUATION PURPOSES ONLY and is not considered by TI to be a finished end product fit for general consumer use. It generates, uses, and can radiate radio frequency energy and has not been tested for compliance with the limits of computing devices pursuant to part 15 of FCC or ICES-003 rules, which are designed to provide reasonable protection against radio frequency interference. Operation of the equipment may cause interference with radio communications, in which case the user at his own expense will be required to take whatever measures may be required to correct this interference.

General Statement for EVMs including a radio

User Power/Frequency Use Obligations: This radio is intended for development/professional use only in legally allocated frequency and power limits. Any use of radio frequencies and/or power availability of this EVM and its development application(s) must comply with local laws governing radio spectrum allocation and power limits for this evaluation module. It is the user's sole responsibility to only operate this radio in legally acceptable frequency space and within legally mandated power limitations. Any exceptions to this are strictly prohibited and unauthorized by Texas Instruments unless user has obtained appropriate experimental/development licenses from local regulatory authorities, which is responsibility of user including its acceptable authorization.

For EVMs annotated as FCC – FEDERAL COMMUNICATIONS COMMISSION Part 15 Compliant

Caution

This device complies with part 15 of the FCC Rules. Operation is subject to the following two conditions: (1) This device may not cause harmful interference, and (2) this device must accept any interference received, including interference that may cause undesired operation.

Changes or modifications not expressly approved by the party responsible for compliance could void the user's authority to operate the equipment.

FCC Interference Statement for Class A EVM devices

This equipment has been tested and found to comply with the limits for a Class A digital device, pursuant to part 15 of the FCC Rules. These limits are designed to provide reasonable protection against harmful interference when the equipment is operated in a commercial environment. This equipment generates, uses, and can radiate radio frequency energy and, if not installed and used in accordance with the instruction manual, may cause harmful interference to radio communications. Operation of this equipment in a residential area is likely to cause harmful interference in which case the user will be required to correct the interference at his own expense.

FCC Interference Statement for Class B EVM devices

This equipment has been tested and found to comply with the limits for a Class B digital device, pursuant to part 15 of the FCC Rules. These limits are designed to provide reasonable protection against harmful interference in a residential installation. This equipment generates, uses and can radiate radio frequency energy and, if not installed and used in accordance with the instructions, may cause harmful interference to radio communications. However, there is no guarantee that interference will not occur in a particular installation. If this equipment does cause harmful interference to radio or television reception, which can be determined by turning the equipment off and on, the user is encouraged to try to correct the interference by one or more of the following measures:

- Reorient or relocate the receiving antenna.
- Increase the separation between the equipment and receiver.
- Connect the equipment into an outlet on a circuit different from that to which the receiver is connected.
- Consult the dealer or an experienced radio/TV technician for help.

For EVMs annotated as IC – INDUSTRY CANADA Compliant

This Class A or B digital apparatus complies with Canadian ICES-003.

Changes or modifications not expressly approved by the party responsible for compliance could void the user's authority to operate the equipment.

Concerning EVMs including radio transmitters

This device complies with Industry Canada licence-exempt RSS standard(s). Operation is subject to the following two conditions: (1) this device may not cause interference, and (2) this device must accept any interference, including interference that may cause undesired operation of the device.

Concerning EVMs including detachable antennas

Under Industry Canada regulations, this radio transmitter may only operate using an antenna of a type and maximum (or lesser) gain approved for the transmitter by Industry Canada. To reduce potential radio interference to other users, the antenna type and its gain should be so chosen that the equivalent isotropically radiated power (e.i.r.p.) is not more than that necessary for successful communication.

This radio transmitter has been approved by Industry Canada to operate with the antenna types listed in the user guide with the maximum permissible gain and required antenna impedance for each antenna type indicated. Antenna types not included in this list, having a gain greater than the maximum gain indicated for that type, are strictly prohibited for use with this device.

Cet appareil numérique de la classe A ou B est conforme à la norme NMB-003 du Canada.

Les changements ou les modifications pas expressément approuvés par la partie responsable de la conformité ont pu vider l'autorité de l'utilisateur pour actionner l'équipement.

Concernant les EVMs avec appareils radio

Le présent appareil est conforme aux CNR d'Industrie Canada applicables aux appareils radio exempts de licence. L'exploitation est autorisée aux deux conditions suivantes : (1) l'appareil ne doit pas produire de brouillage, et (2) l'utilisateur de l'appareil doit accepter tout brouillage radioélectrique subi, même si le brouillage est susceptible d'en compromettre le fonctionnement.

Concernant les EVMs avec antennes détachables

Conformément à la réglementation d'Industrie Canada, le présent émetteur radio peut fonctionner avec une antenne d'un type et d'un gain maximal (ou inférieur) approuvé pour l'émetteur par Industrie Canada. Dans le but de réduire les risques de brouillage radioélectrique à l'intention des autres utilisateurs, il faut choisir le type d'antenne et son gain de sorte que la puissance isotrope rayonnée équivalente (p.i.r.e.) ne dépasse pas l'intensité nécessaire à l'établissement d'une communication satisfaisante.

Le présent émetteur radio a été approuvé par Industrie Canada pour fonctionner avec les types d'antenne énumérés dans le manuel d'usage et ayant un gain admissible maximal et l'impédance requise pour chaque type d'antenne. Les types d'antenne non inclus dans cette liste, ou dont le gain est supérieur au gain maximal indiqué, sont strictement interdits pour l'exploitation de l'émetteur.

【Important Notice for Users of this Product in Japan】

This development kit is NOT certified as Confirming to Technical Regulations of Radio Law of Japan

If you use this product in Japan, you are required by Radio Law of Japan to follow the instructions below with respect to this product:

1. Use this product in a shielded room or any other test facility as defined in the notification #173 issued by Ministry of Internal Affairs and Communications on March 28, 2006, based on Sub-section 1.1 of Article 6 of the Ministry's Rule for Enforcement of Radio Law of Japan,
2. Use this product only after you obtained the license of Test Radio Station as provided in Radio Law of Japan with respect to this product, or
3. Use of this product only after you obtained the Technical Regulations Conformity Certification as provided in Radio Law of Japan with respect to this product. Also, please do not transfer this product, unless you give the same notice above to the transferee. Please note that if you could not follow the instructions above, you will be subject to penalties of Radio Law of Japan.

Texas Instruments Japan Limited
(address) 24-1, Nishi-Shinjuku 6 chome, Shinjuku-ku, Tokyo, Japan

<http://www.tij.co.jp>

【ご使用にあたっての注】

本開発キットは技術基準適合証明を受けておりません。

本製品のご使用に際しては、電波法遵守のため、以下のいずれかの措置を取っていただく必要がありますのでご注意ください。

1. 電波法施行規則第6条第1項第1号に基づく平成18年3月28日総務省告示第173号で定められた電波暗室等の試験設備でご使用いただく。
2. 実験局の免許を取得後ご使用いただく。
3. 技術基準適合証明を取得後ご使用いただく。

なお、本製品は、上記の「ご使用にあたっての注意」を譲渡先、移転先に通知しない限り、譲渡、移転できないものとします。

上記を遵守頂けない場合は、電波法の罰則が適用される可能性があることをご留意ください。

日本テキサス・インスツルメンツ株式会社
東京都新宿区西新宿6丁目24番1号
西新宿三井ビル

<http://www.tij.co.jp>

EVALUATION BOARD/KIT/MODULE (EVM) WARNINGS, RESTRICTIONS AND DISCLAIMERS

For Feasibility Evaluation Only, in Laboratory/Development Environments. Unless otherwise indicated, this EVM is not a finished electrical equipment and not intended for consumer use. It is intended solely for use for preliminary feasibility evaluation in laboratory/development environments by technically qualified electronics experts who are familiar with the dangers and application risks associated with handling electrical mechanical components, systems and subsystems. It should not be used as all or part of a finished end product.

Your Sole Responsibility and Risk. You acknowledge, represent and agree that:

1. You have unique knowledge concerning Federal, State and local regulatory requirements (including but not limited to Food and Drug Administration regulations, if applicable) which relate to your products and which relate to your use (and/or that of your employees, affiliates, contractors or designees) of the EVM for evaluation, testing and other purposes.
2. You have full and exclusive responsibility to assure the safety and compliance of your products with all such laws and other applicable regulatory requirements, and also to assure the safety of any activities to be conducted by you and/or your employees, affiliates, contractors or designees, using the EVM. Further, you are responsible to assure that any interfaces (electronic and/or mechanical) between the EVM and any human body are designed with suitable isolation and means to safely limit accessible leakage currents to minimize the risk of electrical shock hazard.
3. You will employ reasonable safeguards to ensure that your use of the EVM will not result in any property damage, injury or death, even if the EVM should fail to perform as described or expected.
4. You will take care of proper disposal and recycling of the EVM's electronic components and packing materials.

Certain Instructions. It is important to operate this EVM within TI's recommended specifications and environmental considerations per the user guidelines. Exceeding the specified EVM ratings (including but not limited to input and output voltage, current, power, and environmental ranges) may cause property damage, personal injury or death. If there are questions concerning these ratings please contact a TI field representative prior to connecting interface electronics including input power and intended loads. Any loads applied outside of the specified output range may result in unintended and/or inaccurate operation and/or possible permanent damage to the EVM and/or interface electronics. Please consult the EVM User's Guide prior to connecting any load to the EVM output. If there is uncertainty as to the load specification, please contact a TI field representative. During normal operation, some circuit components may have case temperatures greater than 60°C as long as the input and output are maintained at a normal ambient operating temperature. These components include but are not limited to linear regulators, switching transistors, pass transistors, and current sense resistors which can be identified using the EVM schematic located in the EVM User's Guide. When placing measurement probes near these devices during normal operation, please be aware that these devices may be very warm to the touch. As with all electronic evaluation tools, only qualified personnel knowledgeable in electronic measurement and diagnostics normally found in development environments should use these EVMs.

Agreement to Defend, Indemnify and Hold Harmless. You agree to defend, indemnify and hold TI, its licensors and their representatives harmless from and against any and all claims, damages, losses, expenses, costs and liabilities (collectively, "Claims") arising out of or in connection with any use of the EVM that is not in accordance with the terms of the agreement. This obligation shall apply whether Claims arise under law of tort or contract or any other legal theory, and even if the EVM fails to perform as described or expected.

Safety-Critical or Life-Critical Applications. If you intend to evaluate the components for possible use in safety critical applications (such as life support) where a failure of the TI product would reasonably be expected to cause severe personal injury or death, such as devices which are classified as FDA Class III or similar classification, then you must specifically notify TI of such intent and enter into a separate Assurance and Indemnity Agreement.

Mailing Address: Texas Instruments, Post Office Box 655303, Dallas, Texas 75265
Copyright © 2012, Texas Instruments Incorporated

IMPORTANT NOTICE

Texas Instruments Incorporated and its subsidiaries (TI) reserve the right to make corrections, enhancements, improvements and other changes to its semiconductor products and services per JESD46, latest issue, and to discontinue any product or service per JESD48, latest issue. Buyers should obtain the latest relevant information before placing orders and should verify that such information is current and complete. All semiconductor products (also referred to herein as "components") are sold subject to TI's terms and conditions of sale supplied at the time of order acknowledgment.

TI warrants performance of its components to the specifications applicable at the time of sale, in accordance with the warranty in TI's terms and conditions of sale of semiconductor products. Testing and other quality control techniques are used to the extent TI deems necessary to support this warranty. Except where mandated by applicable law, testing of all parameters of each component is not necessarily performed.

TI assumes no liability for applications assistance or the design of Buyers' products. Buyers are responsible for their products and applications using TI components. To minimize the risks associated with Buyers' products and applications, Buyers should provide adequate design and operating safeguards.

TI does not warrant or represent that any license, either express or implied, is granted under any patent right, copyright, mask work right, or other intellectual property right relating to any combination, machine, or process in which TI components or services are used. Information published by TI regarding third-party products or services does not constitute a license to use such products or services or a warranty or endorsement thereof. Use of such information may require a license from a third party under the patents or other intellectual property of the third party, or a license from TI under the patents or other intellectual property of TI.

Reproduction of significant portions of TI information in TI data books or data sheets is permissible only if reproduction is without alteration and is accompanied by all associated warranties, conditions, limitations, and notices. TI is not responsible or liable for such altered documentation. Information of third parties may be subject to additional restrictions.

Resale of TI components or services with statements different from or beyond the parameters stated by TI for that component or service voids all express and any implied warranties for the associated TI component or service and is an unfair and deceptive business practice. TI is not responsible or liable for any such statements.

Buyer acknowledges and agrees that it is solely responsible for compliance with all legal, regulatory and safety-related requirements concerning its products, and any use of TI components in its applications, notwithstanding any applications-related information or support that may be provided by TI. Buyer represents and agrees that it has all the necessary expertise to create and implement safeguards which anticipate dangerous consequences of failures, monitor failures and their consequences, lessen the likelihood of failures that might cause harm and take appropriate remedial actions. Buyer will fully indemnify TI and its representatives against any damages arising out of the use of any TI components in safety-critical applications.

In some cases, TI components may be promoted specifically to facilitate safety-related applications. With such components, TI's goal is to help enable customers to design and create their own end-product solutions that meet applicable functional safety standards and requirements. Nonetheless, such components are subject to these terms.

No TI components are authorized for use in FDA Class III (or similar life-critical medical equipment) unless authorized officers of the parties have executed a special agreement specifically governing such use.

Only those TI components which TI has specifically designated as military grade or "enhanced plastic" are designed and intended for use in military/aerospace applications or environments. Buyer acknowledges and agrees that any military or aerospace use of TI components which have **not** been so designated is solely at the Buyer's risk, and that Buyer is solely responsible for compliance with all legal and regulatory requirements in connection with such use.

TI has specifically designated certain components which meet ISO/TS16949 requirements, mainly for automotive use. Components which have not been so designated are neither designed nor intended for automotive use; and TI will not be responsible for any failure of such components to meet such requirements.

Products

Audio	www.ti.com/audio
Amplifiers	amplifier.ti.com
Data Converters	dataconverter.ti.com
DLP® Products	www.dlp.com
DSP	dsp.ti.com
Clocks and Timers	www.ti.com/clocks
Interface	interface.ti.com
Logic	logic.ti.com
Power Mgmt	power.ti.com
Microcontrollers	microcontroller.ti.com
RFID	www.ti-rfid.com
OMAP Applications Processors	www.ti.com/omap
Wireless Connectivity	www.ti.com/wirelessconnectivity

Applications

Automotive and Transportation	www.ti.com/automotive
Communications and Telecom	www.ti.com/communications
Computers and Peripherals	www.ti.com/computers
Consumer Electronics	www.ti.com/consumer-apps
Energy and Lighting	www.ti.com/energy
Industrial	www.ti.com/industrial
Medical	www.ti.com/medical
Security	www.ti.com/security
Space, Avionics and Defense	www.ti.com/space-avionics-defense
Video and Imaging	www.ti.com/video

TI E2E Community

e2e.ti.com