



MP6650

Single-Phase, BLDC Motor Driver with Integrated Hall Sensor in a TSOT23-6 Package

DESCRIPTION

The MP6650 is a single-phase, brushless, DC motor driver with integrated power MOSFETs and a Hall-effect sensor. The device drives single-phase brushless DC fan motors with up to 2A of output current. The IC has a 3.3V to 18V input voltage range and input line reverse-voltage protection (RVP) to save the external diode on the supply line.

The device controls the rotational speed through the PWM signal on the PWM pin. It has a rotational speed detection feature and rotor lock fault indication on the FG/RD pin with an open-drain output. The output speed vs. the input duty curve can be configured easily for flexible use. To reduce audible fan driver noise and power loss, the MP6650 features a soft on/off phase transition and an automatic phase-lock function of the motor winding BEMF and current.

Full protection features include input over-voltage protection (OVP), under-voltage lockout (UVLO), rotor deadlock (RD) protection, thermal shutdown, and input reverse protection.

The MP6650 requires a minimal number of external components to save solution cost. It is available in TSOT23-6-L, TSOT23-6-R, TSOT23-6-SL, and TSOT23-6-RSL packages.

FEATURES

- Embedded Hall Sensor with High Sensitivity
- Wide 3.3V to 18V Operating Input Range
- Up to 2A Configurable Current Limit
- Integrated Power MOSFETs: Total 740mΩ (HS-FET and LS-FET)
- Configurable Speed Curve
- Built-In Adjustable Speed Curve Corner Setting
- Automatic Phase-Lock Detection of Winding BEMF and Current Zero-Crossing
- Soft On/Off Phase Transition
- Rotational Speed Indicator (FG) Signal
- 2kHz to 100kHz PWM Input Frequency Range
- Fixed 26kHz Output Switching Frequency
- Input Line Reverse Voltage Protection (RVP)
- Rotor Deadlock (RD) Protection
- Thermal Protection and Automatic Recovery
- Built-In Input OVP, UVLO, and Automatic Recovery
- Available in TSOT23-6-L, TSOT23-6-R, TSOT23-6-SL, and TSOT23-6-RSL Packages

APPLICATIONS

- CPU Fan for Personal Computers or Servers
- Brushless DC Motor

All MPS parts are lead-free, halogen-free, and adhere to the RoHS directive. For MPS green status, please visit the MPS website under Quality Assurance. "MPS", the MPS logo, and "Simple, Easy Solutions" are trademarks of Monolithic Power Systems, Inc. or its subsidiaries.

TYPICAL APPLICATION

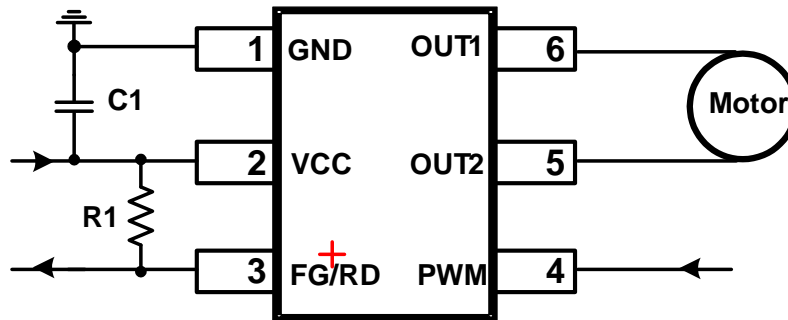

ORDERING INFORMATION

Part Number*	Package	Tape & Reel	Top Marking	MSL Rating
MP6650GJL-xxxx**	TSOT23-6-L	Normal	<i>See Below</i>	Level 1
MP6650GJR-xxxx**	TSOT23-6-R	Reverse		
MP6650GJS-xxxx**	TSOT23-6-SL	Normal		
MP6650GJSR-xxxx**	TSOT23-6-RSL	Reverse		

* For Tape & Reel, add suffix –Z (e.g. MP6650GJS–Z).

** “xxxx” is the configuration code identifier.

The four digits of the suffix (xxxx) can be a hexadecimal value between 0 and F.
Work with an MPS FAE to create this unique number, even if ordering the “0000” code.

TOP MARKING (MP6650GJL and MP6650GJR)

| BGJY

BGJ: Product code of MP6650GJL and MP6650GJR
Y: Year code

TOP MARKING (MP6650GJS and MP6650GJSR)

BGKY

LLL

BGK: Product code of MP6650GJS and MP6650GJSR
Y: Year code
LLL: Lot number

PACKAGE REFERENCE

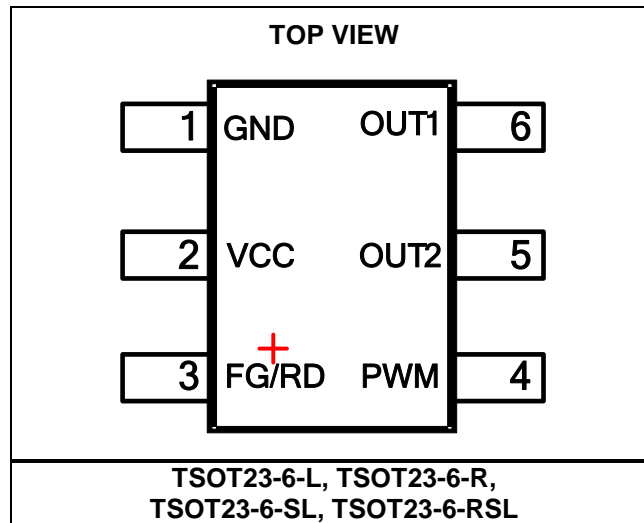

PIN FUNCTIONS

Pin #	Name	Description
1	GND	Ground.
2	VCC	Input voltage supply.
3	FG/RD	Speed indication or rotor lock fault indication output.
4	PWM	Rotational speed control PWM input. PWM 2kHz to 100kHz is recommended in normal operation. PWM is an internal pull-up with a resistance to the internal LDO.
5	OUT2	Motor driver output 2. OUT2 is connected to the mid-point of the internal N-channel MOSFET half-bridge.
6	OUT1	Motor driver output 1. OUT1 is connected to the mid-point of the internal N-channel MOSFET half-bridge.

ABSOLUTE MAXIMUM RATINGS ⁽¹⁾

VCC.....	±22V
VCC (less than 1µs)	25V
PWM, FG/RD, V _{OUT1/2}	-0.3V to +22.3V
Continuous power dissipation (T _A = 25°C) ⁽²⁾	1.25W
Junction temperature	150°C
Lead temperature	260°C
Storage temperature.....	-60°C to +150°C

ESD Rating

Human body model (HBM)	2000V
Charged device model (CDM).....	1000V

Recommended Operating Conditions ⁽³⁾

Supply voltage (VCC)	3.3V to 18V
Operating junction temp (T _J)	-40°C to +125°C

Thermal Resistance ⁽⁴⁾	θ_{JA}	θ_{JC}
TSOT23-6	100.....	55 ... °C/W

Notes:

- 1) Exceeding these ratings may damage the device.
- 2) The maximum allowable power dissipation is a function of the maximum junction temperature T_J (MAX), the junction-to-ambient thermal resistance θ_{JA}, and the ambient temperature T_A. The maximum allowable continuous power dissipation at any ambient temperature is calculated by P_D (MAX) = (T_J (MAX) - T_A) / θ_{JA}. Exceeding the maximum allowable power dissipation produces an excessive die temperature, causing the regulator to go into thermal shutdown. Internal thermal shutdown circuitry protects the device from permanent damage.
- 3) The device is not guaranteed to function based on EC tables outside of its operating conditions.
- 4) Measured on JESD51-7, 4-layer PCB.

ELECTRICAL CHARACTERISTICS

$V_{CC} = 12V$, $T_J = -40^{\circ}C$ to $+125^{\circ}C$, unless otherwise noted.

Parameters	Symbol	Condition	Min	Typ	Max	Units
Input UVLO rising threshold	V_{UVLO}			3	3.25	V
Input UVLO hysteresis				1		V
Operating supply current	I_{CC}			6.5	7.5	mA
Reverse supply current	I_{CCREV}	$V_{CC} = -18V$			1	mA
PWM input high voltage	V_{PWMH}		1.5			V
PWM input low voltage	V_{PWML}				0.4	V
PWM input internal pull-up resistance				41	50	k Ω
HS switch on resistance	R_{HSON}	$I_O = 100mA$, including reversed MOSFET, $T_J = 25^{\circ}C$		480	550	m Ω
LS switch on resistance	R_{LSON}	$I_O = 100mA$, $T_J = 25^{\circ}C$		260	320	m Ω
Over-current limit protection threshold	I_{OCP}			3		A
Output current limit	I_{LMT}	$SUCL = 11$	1.7	2	2.3	A
PWM output frequency	f_s	$T_J = 25^{\circ}C$	22.1	26	29.9	kHz
FG output low-level voltage	V_{FG_L}	$IFG/RD = 3mA$, $V_{PULL} = 5V$			0.35	V
FG leakage current					1	μA
OVP rising threshold	V_{OVP}		18.2	19.2	20.2	V
OVP hysteresis	V_{OVP_HYS}			0.9		V
Soft turn-on angle	θ_{SON_100}	PWM duty = 100%		22.5		$^{\circ}$
Soft turn-off angle	θ_{SOFF_100}	PWM duty = 100%		45		$^{\circ}$
Rotor lock detection time	t_{RD}		0.45	0.6	0.75	s
Operate point	B_{OP}			1	2	mT
Release point	B_{RP}		-2	-1		
Hysteresis for operate point and release point	B_{HYS}			2	4	
Symmetry for operate points and release point	B_{SYM}			0	0.4	
Thermal shutdown threshold ⁽⁵⁾				150		$^{\circ}C$
Thermal shutdown hysteresis ⁽⁵⁾				25		$^{\circ}C$

Note:

5) Guaranteed by design.

TYPICAL PERFORMANCE CHARACTERISTICS

$V_{CC} = 12V$, $T_A = 25^\circ C$, tested with fan unit, unless otherwise noted.

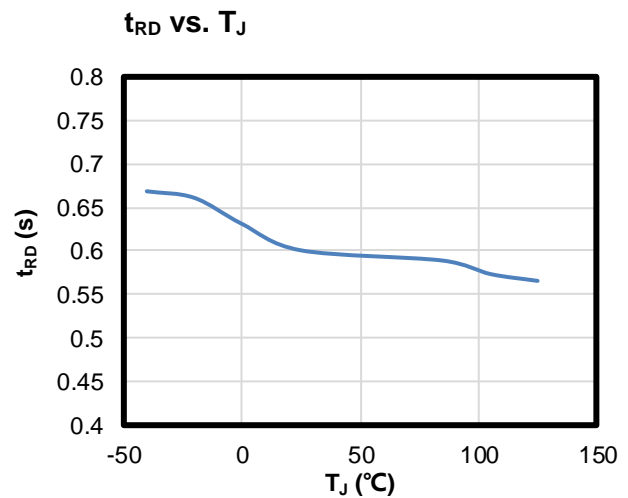
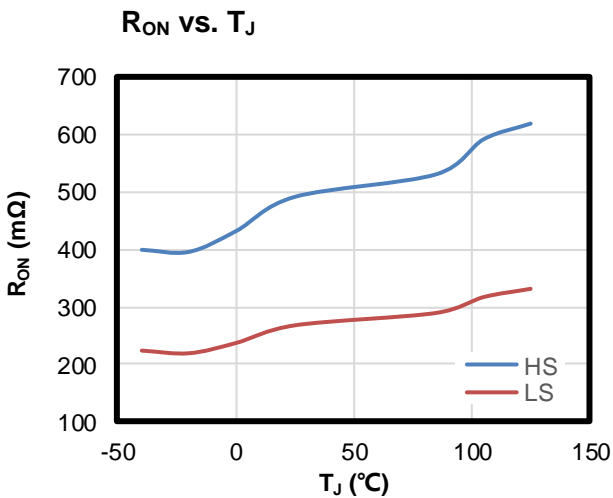
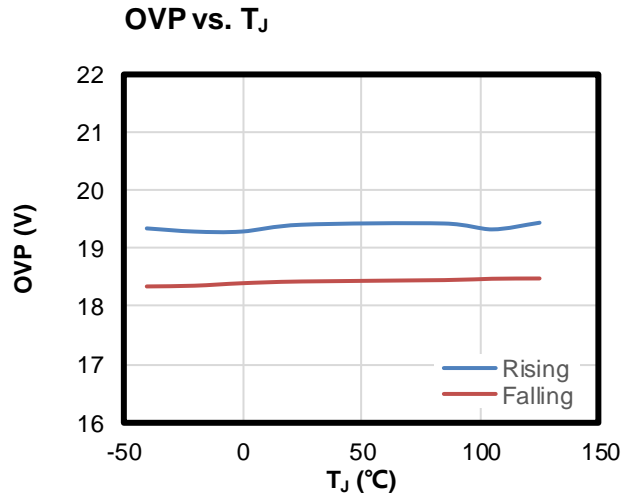
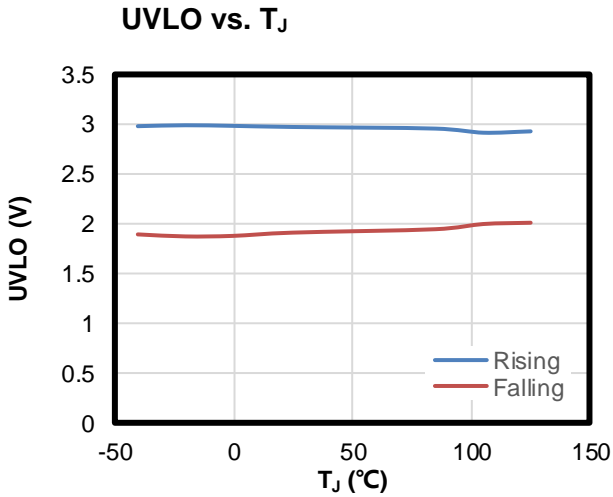
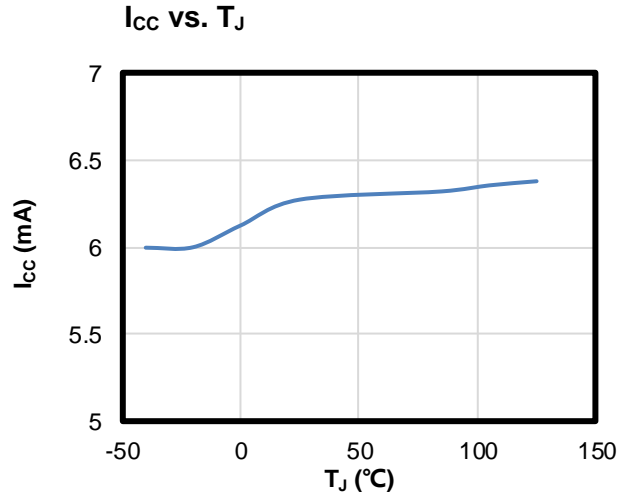
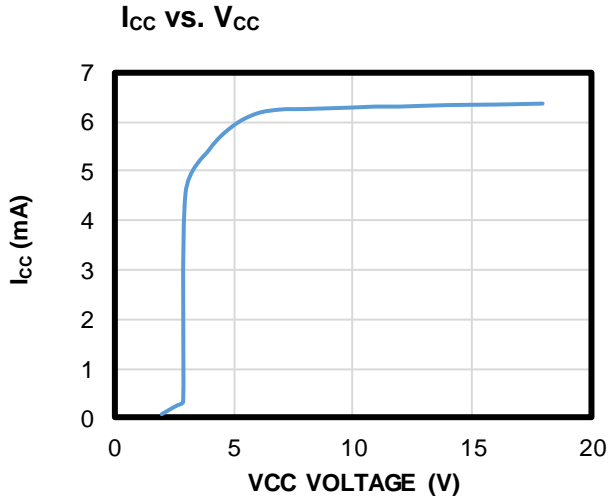

TYPICAL PERFORMANCE CHARACTERISTICS (continued)

$V_{CC} = 12V$, $T_A = 25^\circ C$, tested with fan unit, unless otherwise noted.

100% Duty Output

$V_{CC} = 12V$ DC, PWM = 25kHz, 100% duty

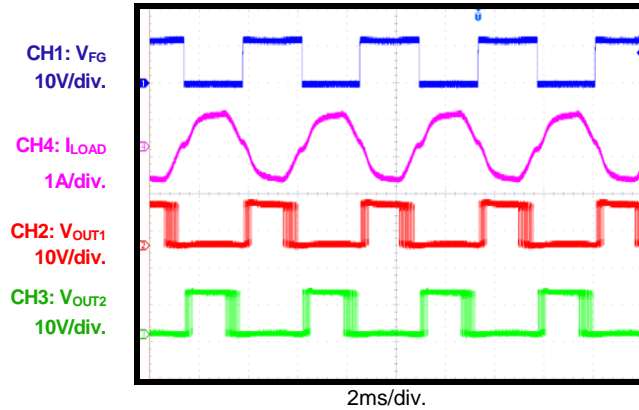
50% Duty Output

$V_{CC} = 12V$ DC, PWM = 25kHz, 50% duty

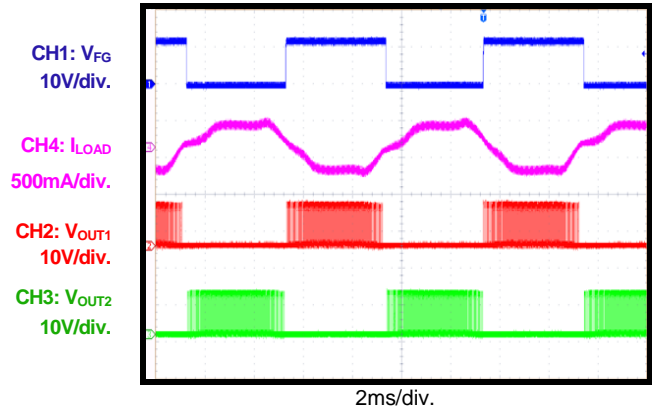
Switching Soft On and Soft Off

$V_{CC} = 12V$ DC, PWM = 5V DC,
soft on/off phase transition

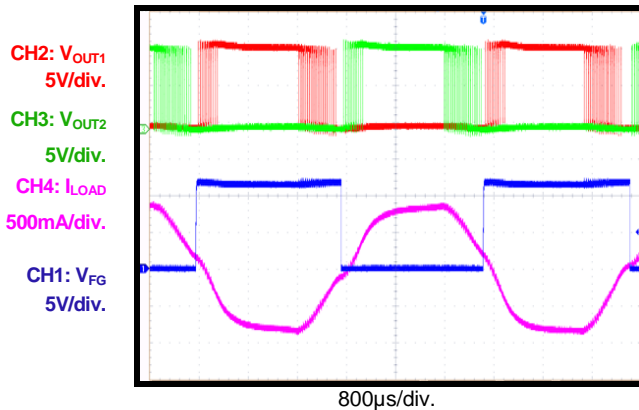
Enable Soft On and Soft Off

$V_{CC} = 12V$ DC, PWM = 5V DC,
soft on/off phase transition

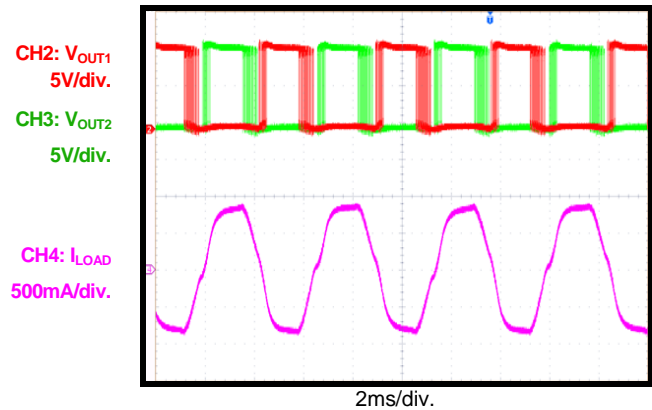
Disable Soft On and Soft Off

$V_{CC} = 12V$ DC, PWM = 5V DC,
soft on/off phase transition

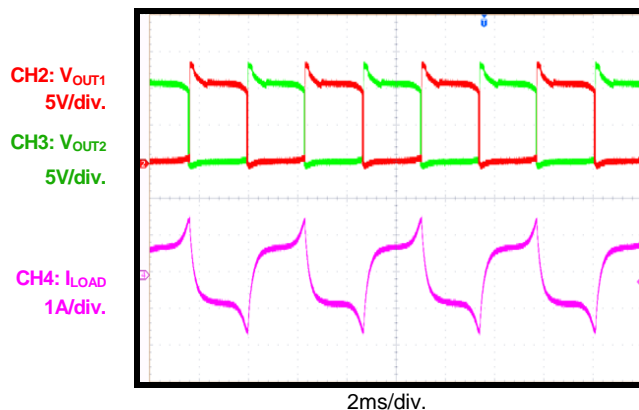
Start-Up with PWM

$V_{CC} = 12V$ DC, PWM = 0V to 5V DC

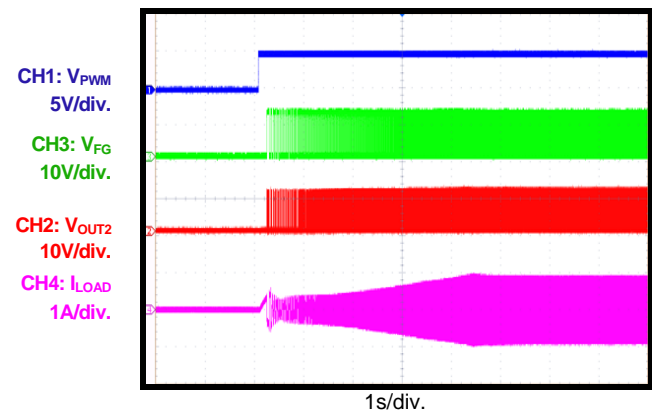

TYPICAL PERFORMANCE CHARACTERISTICS (continued)

$V_{CC} = 12V$, $T_A = 25^\circ C$, tested with fan unit, unless otherwise noted.

Shutdown with PWM

$V_{CC} = 12V$ DC, PWM = 5V to 0V DC

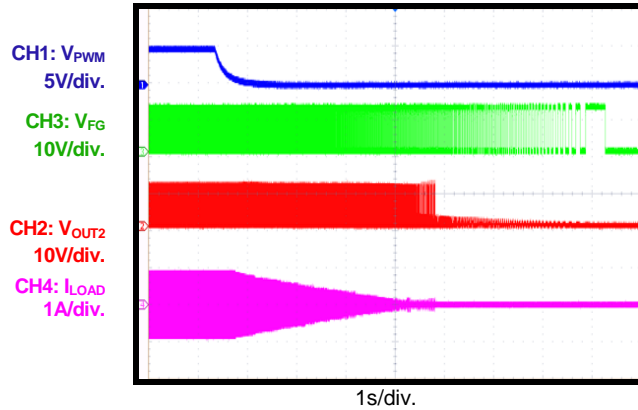
Start-Up with VCC

$V_{CC} = 0V$ to 12V DC, PWM = 5V DC

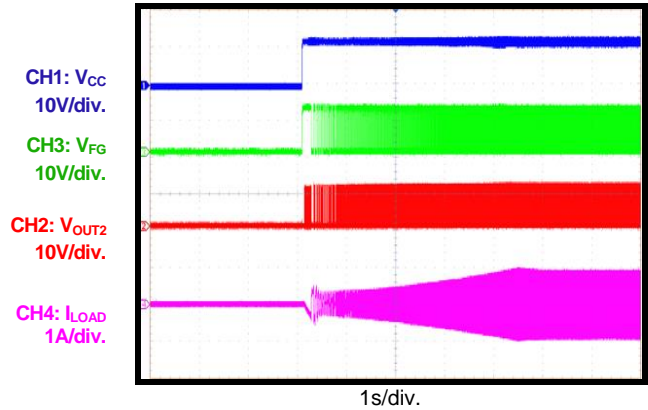
Shutdown with VCC

$V_{CC} = 12V$ to 0V DC, PWM = 5V DC

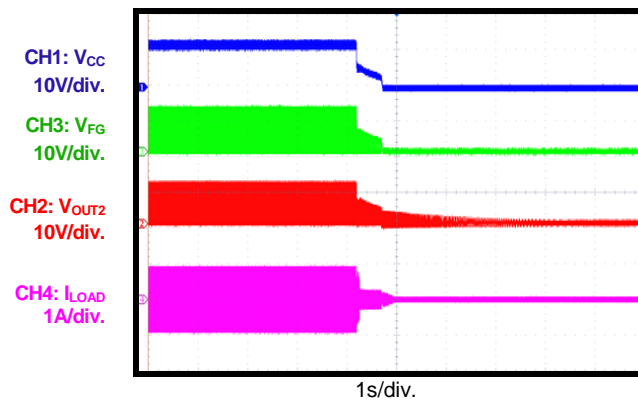
Rotor Lock and Release

$V_{CC} = 12V$ DC, PWM = 5V DC, lock rotor and release

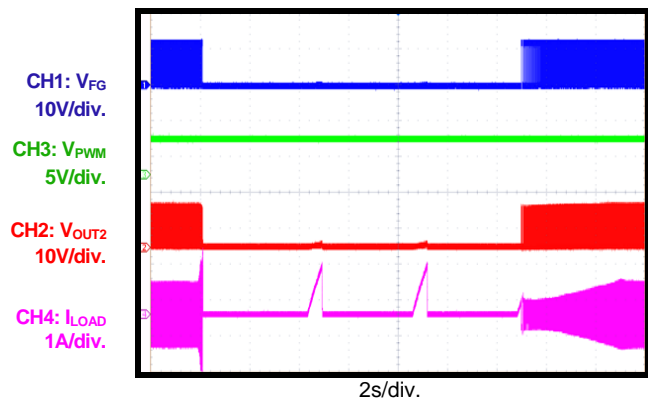
Rotor Lock and Release

$V_{CC} = 12V$ DC, PWM = 5V DC, lock rotor and release

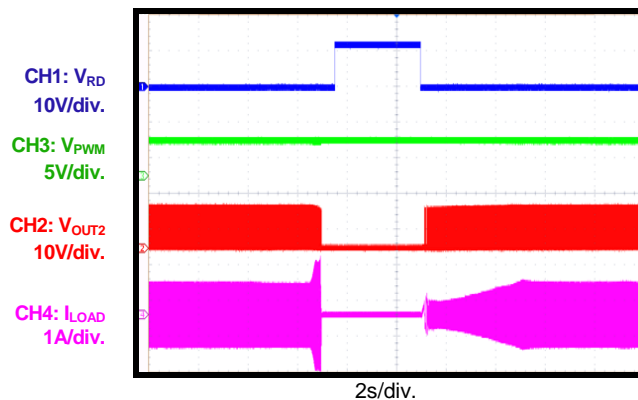
Over-Voltage Protection

$V_{CC} = 12V$ DC, 19.1V to 18.3V, PWM = 25kHz, 100% duty test with fan unit

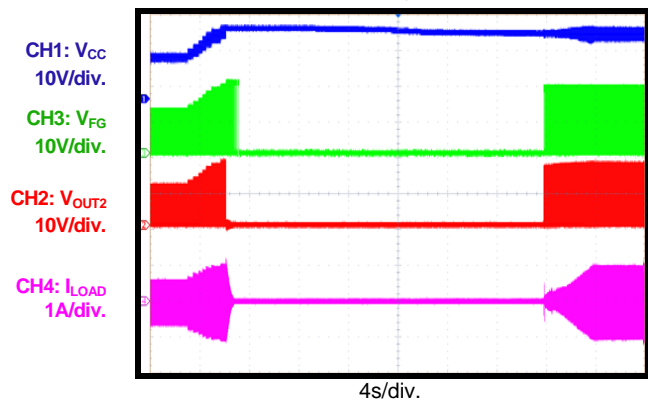

TYPICAL PERFORMANCE CHARACTERISTICS *(continued)*

$V_{CC} = 12V$, $T_A = 25^\circ C$, tested with fan unit, unless otherwise noted.

VCC Reverse Protection

$V_{CC} = 0V$ to $-18V$ DC to $0V$ to $+18V$ DC

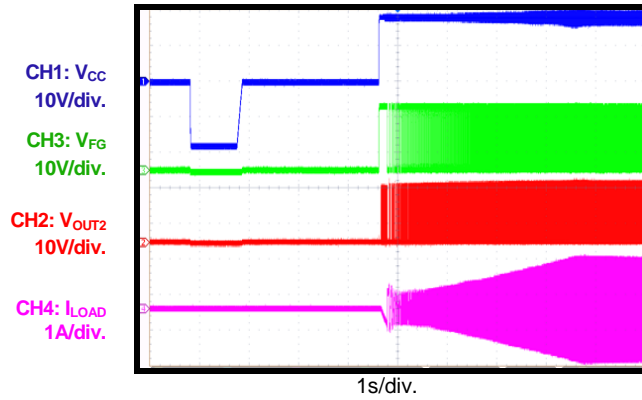

RPM Output vs. PWM Input Duty

$V_{CC} = 12V$ DC, PWM = 23.6kHz,

test with fan unit, default register setting

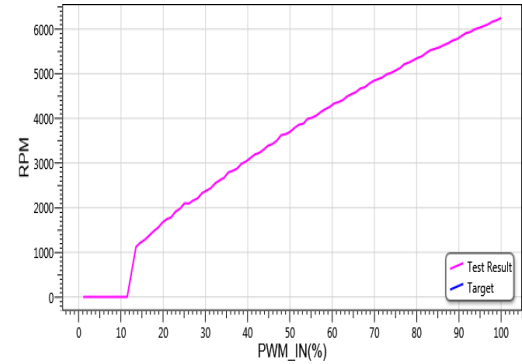

FUNCTIONAL BLOCK DIAGRAM

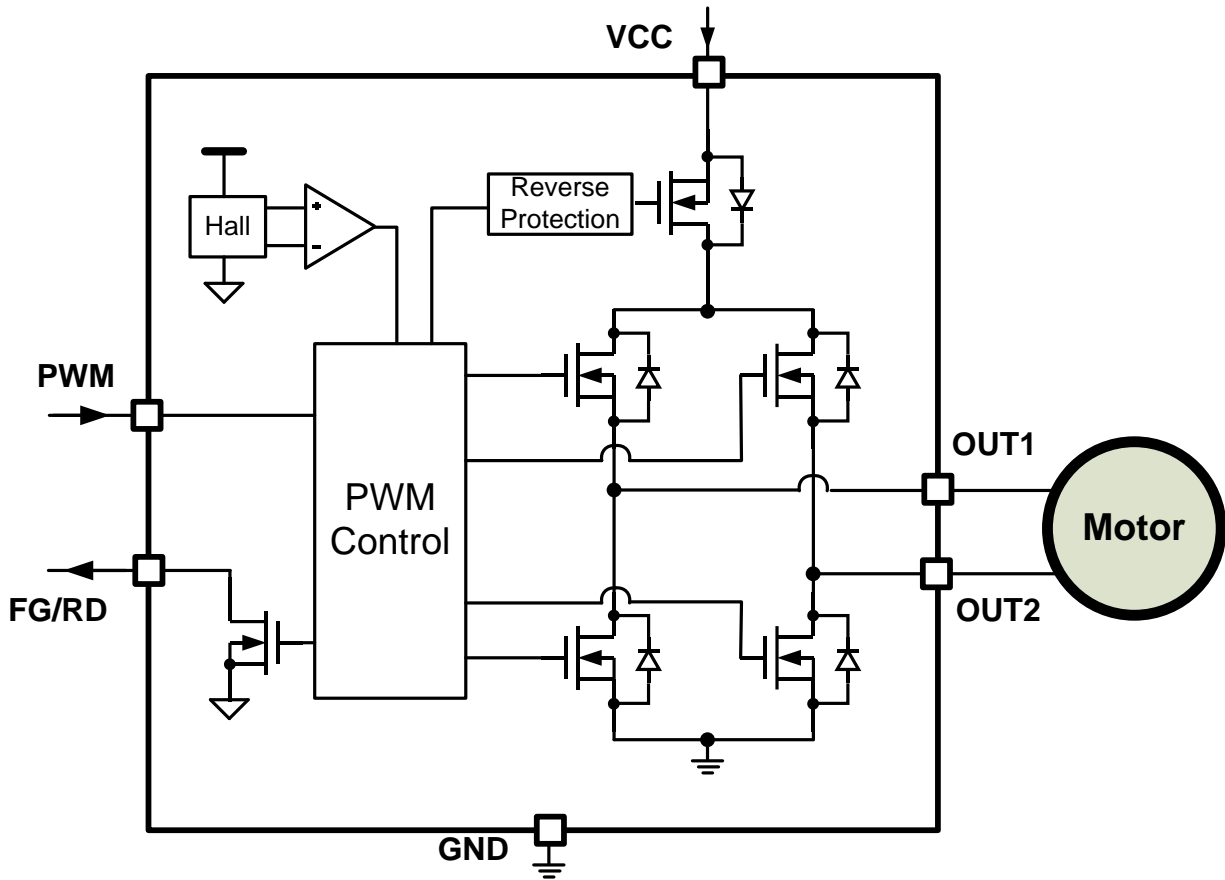

Figure 1: Functional Block Diagram

OPERATION

The MP6650 is a single-phase, brushless, DC motor driver with integrated power MOSFETs and a Hall-effect sensor.

Speed Control

The device is controlled using a pulse-width modulation (PWM) input interface that is compatible with industry-standard devices. The IC detects the PWM input signal duty cycle and linearly controls the H-bridge output duty cycle, so the fan speed increases as the input duty cycle increases.

The PWM input accepts a wide input frequency range of 2kHz to 100kHz, while the output frequency is maintained at 26kHz above the audible frequency range.

PWM Output Drive

The IC controls the H-bridge MOSFET switching to reduce speed variation and increase system efficiency (see Figure 2).

When the rotor magnet pole S approaches, the internal Hall sensor outputs high. When the rotor magnet pole N approaches, the internal Hall sensor outputs low. With this Hall signal, the IC enables a soft-on transition or soft-off transition to maintain a smooth current and reduce fan vibration.

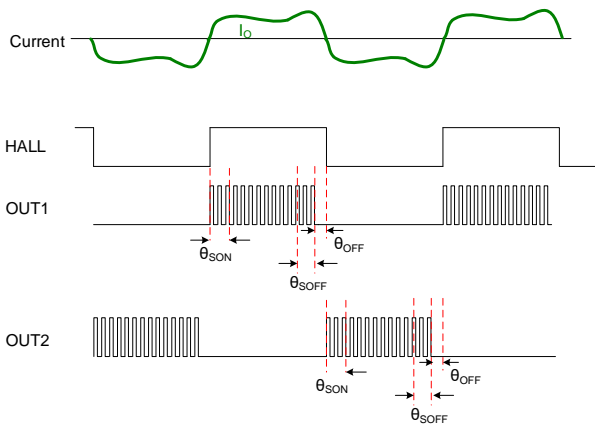

Figure 2: Timing Diagram

Soft Turn-On

During soft turn-on, OUT1 continues switching, and the duty cycle increases gradually from 0 to the target setting duty cycle in a maximum of 16 steps while OUT2 remains low. The soft-on angle lasts for 22.5 degrees when the output duty cycle is 100%, and the soft-on angle lasts

for 45 degrees when the output duty cycle is 12.5%. Interpolation between the two output duties is linear (see Figure 3).

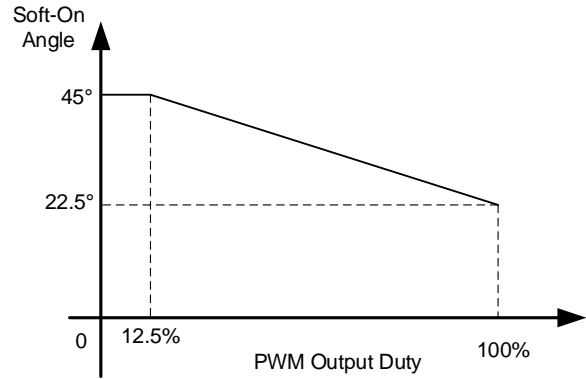

Figure 3: Soft-On Angle vs. Output Duty

Normal PWM Switching

While the PWM switches normally, OUT1 continues switching, and the duty cycle remains fixed at the target setting duty. OUT2 remains low.

Soft Turn-Off

During soft turn-off, OUT1 continues switching, and the duty cycle decreases gradually from the target setting duty cycle to 0 in a maximum of 16 steps while OUT2 remains low. The soft-off angle lasts for 45 degrees when the output duty cycle is 100%, and the soft-off angle lasts for 22.5 degrees when the output duty cycle is 12.5%. Interpolation between the two output duties is linear (see Figure 4).

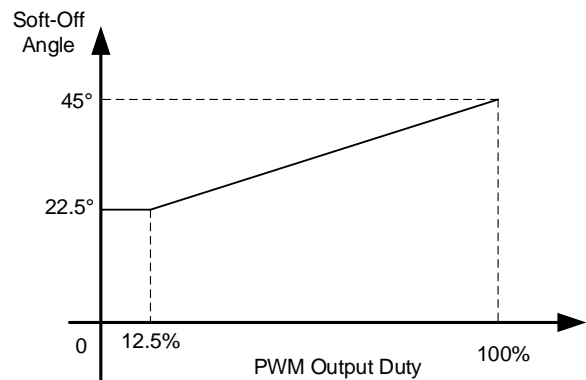

Figure 4: Soft-Off Angle vs. Output Duty

Off

During this time, OUT1 remains at high impedance, and OUT2 remains low. The time duration is adaptive from 0 degrees to 45 degrees. In steady state, this function block maintains the phase lock of the Hall output falling edge and winding current zero-crossing edge.

When the Hall output is at a low interval, the conducting phase changes, but the switching sequence remains the same.

PWM Input Starting Duty

The start-up duty of the PWM input is determined by the 14H register value set by the register. An example is below:

SPD_ZERO = 1, 14H = 0x20 (12.5%)

When the input duty is less than 12.5%, the fan maintains a zero speed. When the input duty is above 13.7% (hysteresis 1.2%), the fan starts rotating. The speed is based on the 00h to 08h duty cycle setting (see Figure 5).

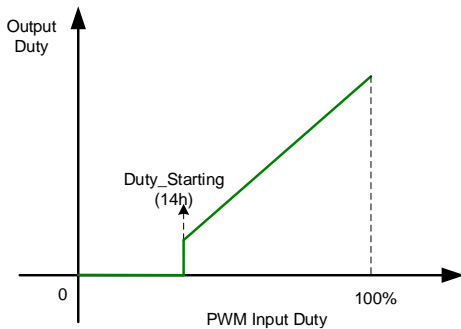

Figure 5: Configurable Speed Curve

SPD_ZERO = 0, 14H = 0x20 (12.5%)

When the input duty is less than 12.5%, the fan keeps a minimum PWM output duty cycle set by the 00h to 08h register setting (see Figure 6).

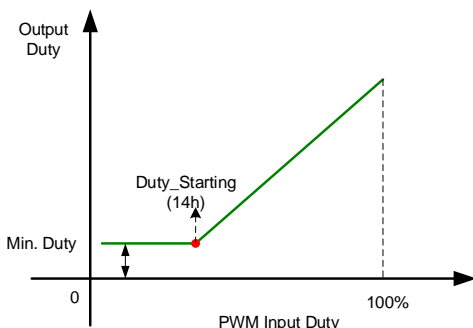

Figure 6: Configurable Speed Curve

Protection Circuits

The MP6650 is fully protected against over-voltage, under-voltage, over-current, and over-temperature events. It also has input reverse protection.

Over-Current Protection (OCP)

The MP6650 protects against internal overload and short circuit by detecting the current flowing through each MOSFET. If the current flowing through any MOSFET exceeds the over-current protection (OCP) threshold after about 1.5µs of blanking time, that MOSFET turns off immediately. After the lock-retry time delay (default 3.6s), the bridge re-enables automatically.

Overload Current Limit

During normal switching, if the current flowing through the high-side MOSFET (HS-FET) of the H-bridge exceeds the threshold set by the SUCR register bits after about 1.5µs of blanking time, the HS-FET turns off immediately. The HS-FET resumes switching in the next switching cycle. The overload current limit is configurable with 0.7A, 1.1A, 1.6A, or 2A. The default limit is 1.6A.

Thermal Shutdown

Thermal monitoring is also integrated into the MP6650. If the die temperature exceeds 150°C, the MOSFETs of the switching half-bridge turn off. Once the die temperature drops to a safe temperature, operation resumes automatically.

Under-Voltage Lockout (UVLO)

If at any time V_{CC} falls below the under-voltage lockout (UVLO) threshold voltage, all circuitry in the device disables, and the internal logic resets. Operation resumes when V_{CC} rises above the UVLO threshold.

Rotor Deadlock Protection (RD)

The MP6650 detects the internal Hall signal and outputs a deadlock indication signal to the FG/RD pin if the FGRD bit is set to 11. If the IC cannot see the Hall signal edge change during the 0.6s detection time, the low-side MOSFETs of the H-bridge turn on. After 1.8s, 2.4s, 3s, or 3.6s of lock-retry time (depending on the RLOCK_SEL bit's setting), the IC attempts to start up again automatically. FG/RD pin outputs again only after three Hall signal edges are

detected after the rotor lock condition is released (see Figure 7).

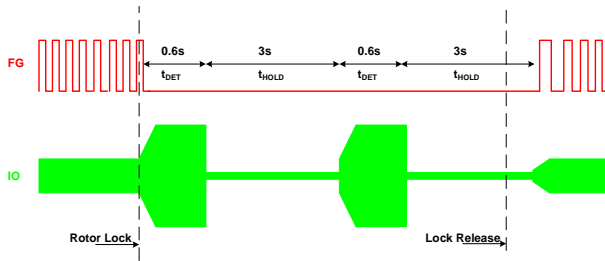

Figure 7: Rotor Deadlock Protection

Rotor Speed Indication (FG)

The device outputs a Hall detection signal to the FG/RD pin as speed indication. The output signal frequency can be optional for 100% or 50% of the internal Hall sensor output frequency. FG/RD pin is an open drain, and requires a pull-up resistor in the application.

Over-Voltage Protection (OVP)

If V_{CC} exceeds the over-voltage threshold (19.2V), the IC turns off the two HS-FETs and turns on the two low-side MOSFETs (LS-FET) until V_{CC} drops below 18.3V. Then the IC resumes normal operation.

Input Reverse Connection Protection

If the input line is reverse-connected to V_{CC} and GND, the IC detects the fault condition automatically and shuts down to avoid damage.

Soft-Start Time

To reduce the input rush current when the duty changes, the MP6650 initiates a soft start to ramp up/down PWM input reference smoothly. This soft duty changing time is either 2.6s or the default 5.2s, and is selectable by the TSS bit.

Test Mode and Factory Mode

To program the internal register, the MP6650 has a test mode. In this test mode, all internal registers can be read/write. After completing the design, the register value can be programmed to the non-volatile memory. The non-volatile memory can be programmed twice. Refer to MPS Phase Fan Driver GUI Software for easy parameter changes and memory programming.

REGISTER MAP

Add	Type	D7	D6	D5	D4	D3	D2	D1	D0
00H-08H	OTP/REG	PWMO[7:0]							
09H	OTP/REG	PROG[1:0]		Reserved					
0AH	OTP/REG	FGRD[1:0]		RPMS[2:0]			TSS	SUCL[1:0]	
0BH	OTP/REG	FG	TM	SPD_ZERO	Reserved				
0DH	OTP/REG		SOFTEN	RD_HL	Reserved				
0FH	OTP/REG		PLEN	RLOCK_SEL[1:0]		Reserved			
10H	REG	Reserved					FM	Reserved	
14H	OTP/REG	DUTY_STARTING[7:0]							

Register Table 1-9

Addr: 0x00 to 0x08					
Bit	Bit Name	Access	Addr	Default	Description
7:0	PWMO	OTP/REG	0x00	0x1F	Output duty cycle lookup table.
			0x01	0x1F	
			0x02	0x3F	
			0x03	0x5F	
			0x04	0x7F	
			0x05	0x9F	
			0x06	0xBF	
			0x07	0xDF	
			0x08	0xFF	

Register Table 10

Addr: 0x09				
Bit	Bit Name	Access	Default	Description
7:6	PROG	OTP/REG	00	Indication of OTP flash. 00: Not programmed 01: Programmed once 10: Programmed twice
5:0	Reserved			

Register Table 11

Addr: 0x0A				
Bit	Bit Name	Access	Default	Description
7:6	FGRD	OTP/REG	00	FG or RD output selection. 00: FG 01: 1/2 x FG 11: RD
5:3	RPMS	OTP/REG	011	Minimum speed supported. This setting influences the internal clock's calculation. A higher value leads to higher calculation resolution. 000: 50rpm 001: 100rpm 010: 200rpm 011: 400rpm 100: 800rpm 101: 1600rpm 110: 3200rpm
2	TSS	OTP/REG	1	PWM input duty soft-start time. 1: 5.2s 0: 2.6

1:0	SUCL	OTP/REG	10	Current limit. Default is 1.6A. 00: 0.7A 01: 1.1A 10: 1.6A 11: 2A
-----	------	---------	----	---

Register Table 12

Addr: 0x0B				
Bit	Bit Name	Access	Default	Description
7	FG	REG	0	FG signal indication bit (read-only).
6	TM	REG	0	Test mode indication (read-only). In test mode, turn on all functions except for the OTP flash block. 0: Normal operation 1: Test mode
5	SPD_ZERO	OTP/REG	1	Zero speed enable bit 1: Enabled 0: Disabled
4:0	Reserve			

Register Table 13

Addr: 0x0D				
Bit	Bit Name	Access	Default	Description
7	Reserved			
6	SOFTEN	OTP/REG	1	Soft switching function enable bit. 1: Soft function enable 0: Soft function disable
5	RD_HL	OTP/REG	0	RD polarity set when rotor is locked. Default is 0. 0: RD high when locked 1: RD low when locked
4:0	Reserved			

Register Table 14

Addr: 0x0F				
Bit	Bit Name	Access	Default	Description
7	Reserved			
6	PLLEN	OTP/REG	1	Load current zero-crossing PLL function enable bit. 1: Enabled 0: Disabled. Recommended for applications where input current is below 100mA
5:4	RLOCK_SEL	OTP/REG	11	Rotor lock-retry time to detect time ratio selection. 00: 1:3 (0.6s/1.8s) 01: 1:4 (0.6s/2.4s) 10: 1:5 (0.6s/3.0s) 11: 1:6 (0.6s/3.6s)
3:0	Reserved			

Register Table 15

Addr: 0x14				
Bit	Bit Name	Access	Default	Description
7:0	DUTY_ STARTING	OTP/REG	20H	PWM input starting duty cycle. FFH: 100% 00H: 0%

APPLICATION INFORMATION

Selecting the Input Capacitor

Place an input capacitor (C1) near VCC to maintain a stable input voltage and reduce input switching voltage noise and ripple. The input capacitor impedance must be low at the switching frequency. Ceramic capacitors with X7R dielectrics are recommended due to their low ESR characteristics.

Ensure that the ceramic capacitance is based on the voltage rating. The DC bias voltage and value can lose as much as 50% of its capacitance at its rated voltage rating. Leave enough voltage rating margin when selecting the component. For applications requiring less than 500mA, a 0.22 μ F to 1 μ F ceramic capacitor is sufficient. If required, add an additional, large electrolytic capacitor to absorb inductor energy.

Input Snubber

Because the input capacitor charges and discharges energy during the phase transition soft switching, the input current has switching cycle ringing. If required, add a 2 Ω resistor in series with the capacitor as an R-C.

Hall Sensor Position

The Hall sensor cell is located in the lower-left corner of the package (see Figure 8).

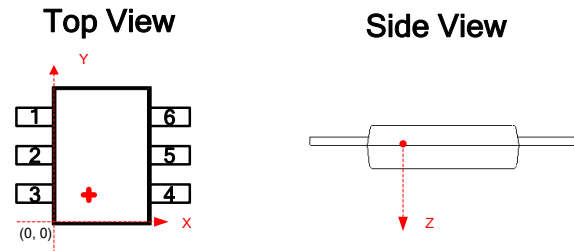

(X, Y, Z) = (540 μ m, 508 μ m, 80 μ m)

Figure 8: Hall Sensor Position

Input Clamping Circuits

High voltage spikes may be caused by back-EMF energy stored in the rotor, typically for high-current and inertia fans. It is recommended to add an input clamping TVS circuit. An SOD-323 package usually suffices. If an input clamping TVS circuit is needed, see the Typical Application Circuit section on page 19 for circuit details. For <300mA, <8cm fans, these circuits are usually not needed.

TYPICAL APPLICATION CIRCUIT

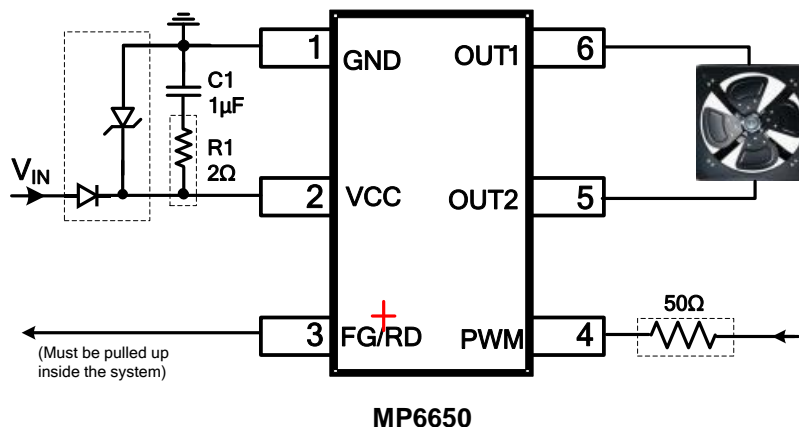
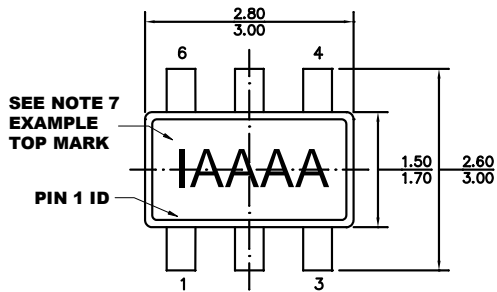

Figure 9: Typical Application Circuit for 12V VCC Input

PACKAGE INFORMATION

TSOT23-6-L



TOP VIEW

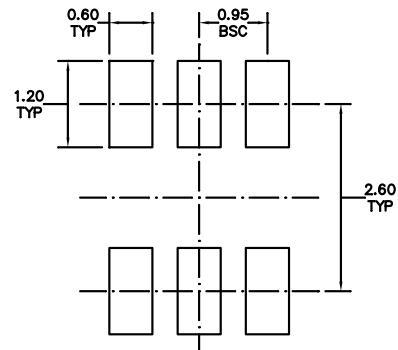

RECOMMENDED LAND PATTERN

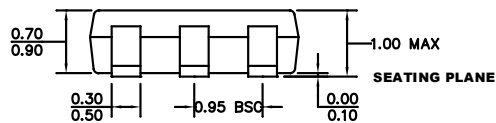

FRONT VIEW

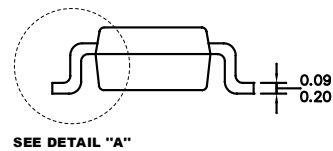

SIDE VIEW

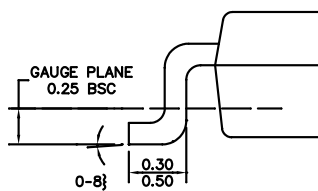

DETAIL "A"

NOTE:

- 1) ALL DIMENSIONS ARE IN MILLIMETERS.
- 2) PACKAGE LENGTH DOES NOT INCLUDE MOLD FLASH, PROTRUSION, OR GATE BURR.
- 3) PACKAGE WIDTH DOES NOT INCLUDE INTERLEAD FLASH OR PROTRUSION.
- 4) LEAD COPLANARITY (BOTTOM OF LEADS AFTER FORMING) SHALL BE 0.10 MILLIMETERS MAX.
- 5) DRAWING CONFORMS TO JEDEC MO-193, VARIATION AB.
- 6) DRAWING IS NOT TO SCALE.
- 7) PIN 1 IS LOWER-LEFT PIN WHEN READING TOP MARK FROM LEFT TO RIGHT (SEE EXAMPLE TOP MARK).

PACKAGE INFORMATION

TSOT23-6-R

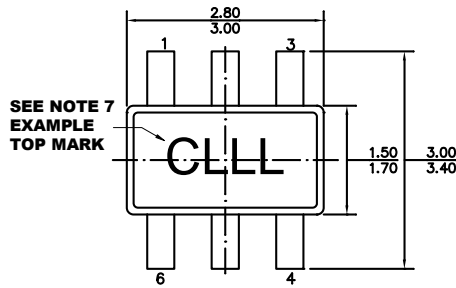

TOP VIEW

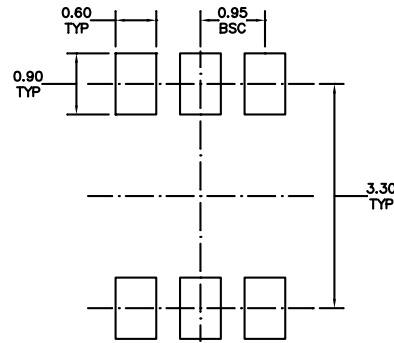

RECOMMENDED LAND PATTERN

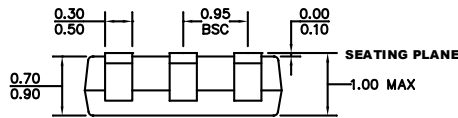

FRONT VIEW

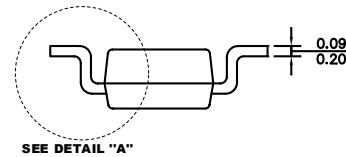

SIDE VIEW

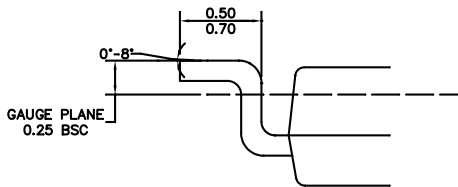

DETAIL "A"

NOTE:

- 1) ALL DIMENSIONS ARE IN MILLIMETERS.
- 2) PACKAGE LENGTH DOES NOT INCLUDE MOLD FLASH, PROTRUSION, OR GATE BURR.
- 3) PACKAGE WIDTH DOES NOT INCLUDE INTERLEAD FLASH OR PROTRUSION.
- 4) LEAD COPLANARITY (BOTTOM OF LEADS AFTER FORMING) SHALL BE 0.10 MILLIMETERS MAX.
- 5) DRAWING REFERENCE TO JEDEC MO-193.
- 6) DRAWING IS NOT TO SCALE.
- 7) PIN 1 IS UPPER-LEFT PIN WHEN READING TOP MARK FROM LEFT TO RIGHT (SEE EXAMPLE TOP MARK).

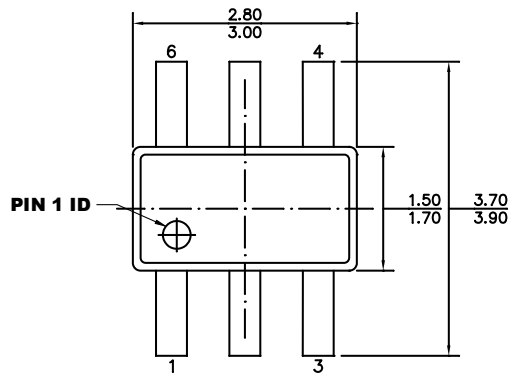
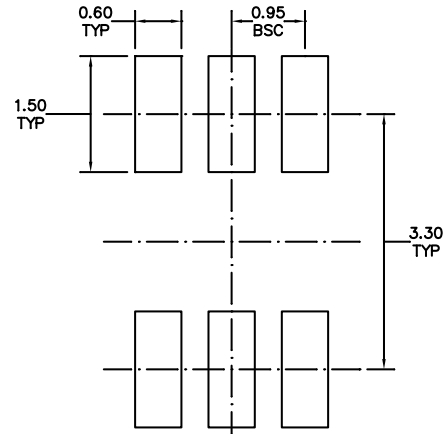
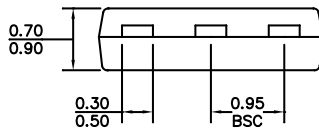
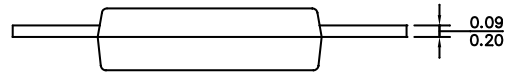
PACKAGE INFORMATION
TSOT23-6-SL

TOP VIEW

RECOMMENDED LAND PATTERN

FRONT VIEW

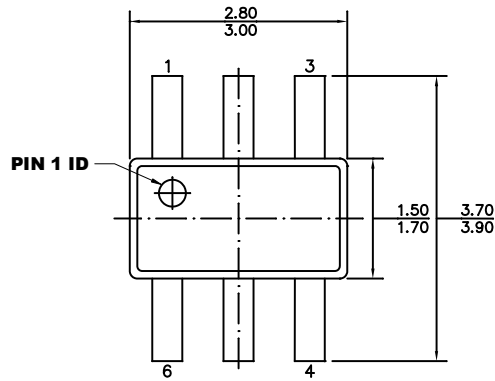
SIDE VIEW
NOTE:

- 1) ALL DIMENSIONS ARE IN MILLIMETERS.
- 2) PACKAGE LENGTH DOES NOT INCLUDE MOLD FLASH, PROTRUSION, OR GATE BURR.
- 3) PACKAGE WIDTH DOES NOT INCLUDE INTERLEAD FLASH OR PROTRUSION.
- 4) LEAD COPLANARITY (BOTTOM OF LEADS AFTER FORMING) SHALL BE 0.10 MILLIMETERS MAX.
- 5) DRAWING REFERENCE IS JEDEC MO-193.
- 6) DRAWING IS NOT TO SCALE.

PACKAGE INFORMATION

TSOT23-6-RSL



TOP VIEW

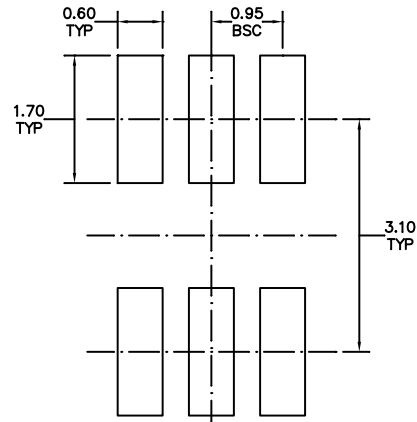

RECOMMENDED LAND PATTERN

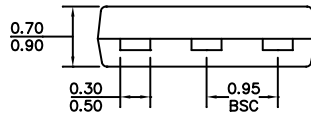

FRONT VIEW

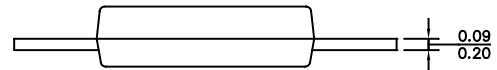

SIDE VIEW

NOTE:

- 1) ALL DIMENSIONS ARE IN MILLIMETERS.
- 2) PACKAGE LENGTH DOES NOT INCLUDE MOLD FLASH, PROTRUSION, OR GATE BURR.
- 3) PACKAGE WIDTH DOES NOT INCLUDE INTERLEAD FLASH OR PROTRUSION.
- 4) LEAD COPLANARITY (BOTTOM OF LEADS AFTER FORMING) SHALL BE 0.10 MILLIMETERS MAX.
- 5) DRAWING REFERENCE IS JEDEC MO-193.
- 6) DRAWING IS NOT TO SCALE.

CARRIER INFORMATION

TSOT23-6-L and TSOT23-6-SL

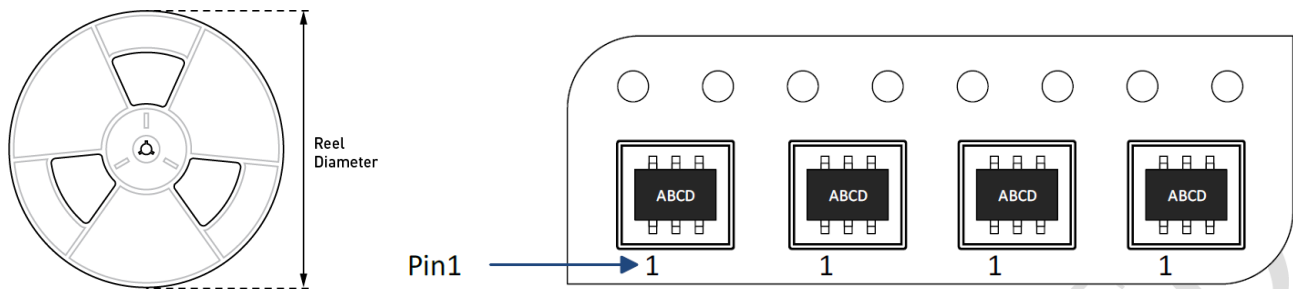

TSOT23-6-R and TSOT23-6-RSL

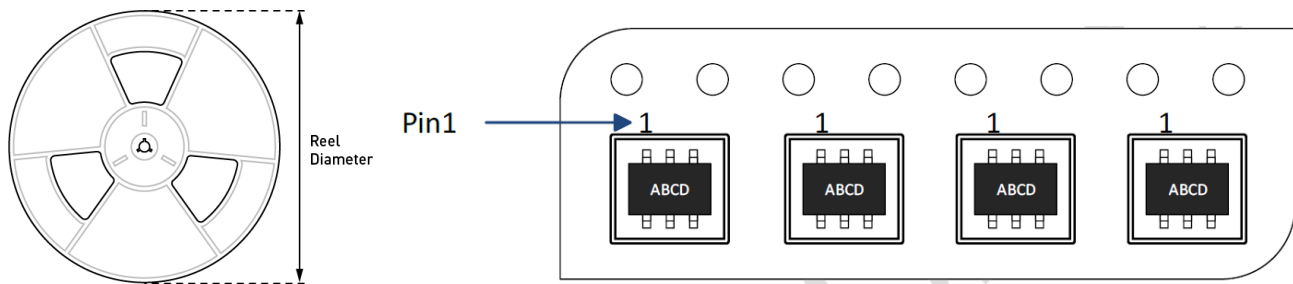

Part Number	Package Description	Quantity/Reel	Quantity/Tube	Reel Diameter	Carrier Tape Width	Carrier Tape Pitch
MP6650GJL-Z	TSOT23-6-L	5000	N/A	13in	12mm	8mm
MP6650GJS-Z	TSOT23-6-SL	5000	N/A	13in	12mm	8mm
MP6650GJR-Z	TSOT23-6-R	5000	N/A	13in	12mm	8mm
MP6650GJSR-Z	TSOT23-6-RSL	5000	N/A	13in	12mm	8mm

Notice: The information in this document is subject to change without notice. Users should warrant and guarantee that third-party Intellectual Property rights are not infringed upon when integrating MPS products into any application. MPS will not assume any legal responsibility for any said applications.