

**Leaded common mode choke coil**  
**PLT10HN□□□□□□P0B Reference Specification**

**1. Scope**

This reference specification applies to Leaded common mode choke coil PLT10HN Series.

**2. Part Numbering**

(Ex.) PLT 10H N 401 100 P 0 B  
 Product ID Type Application Common Mode Rated Winding Dimension Packaging  
 Impedance Zc Current Mode code

**3. Rating**

Customer Part Number	MURATA Part Number	Common Mode Impedance Zc (at10MHz) Typ.	Rated Voltage	Withstand Voltage	* Rated Current	DC Resistance (Rdc)	Insulation Resistance (I.R.)	Inductance (L)
	PLT10HN401100P0B	400Ω	100V (DC)	250V (DC)	10A	3.6mΩ ±0.5mΩ	10MΩ min.	6μH min.
	PLT10HN101150P0B	100Ω	300V (DC)	750V (DC)	15A	1.8mΩ ±0.5mΩ	10MΩ min.	2.0μH min.
	PLT10HN450180P0B	45Ω	300V (DC)	750V (DC)	18A	1.3mΩ ±0.5mΩ	10MΩ min.	0.8μH min.

- Operating Temperature range (Product temperature; Self- temperature rise is included) : -55°C~+125°C
- Storage Temperature range : -55°C~+125°C

\* Rated Current is derated as below figure depending on the operating temperature.

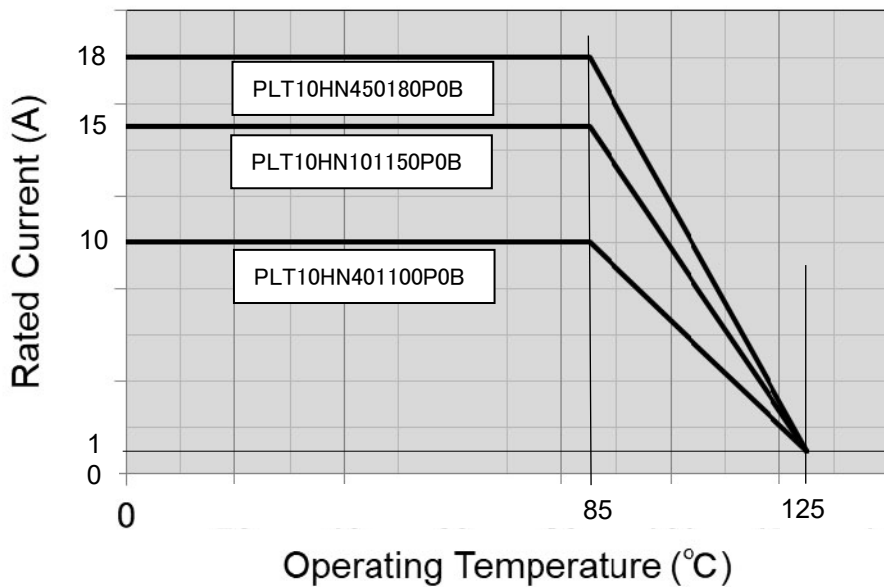

**4. Standard Testing Conditions**

< Unless otherwise specified >

Temperature: Ordinary Temp.15 °C to 35 °C  
 Humidity: Ordinary Humidity 25 %(RH) to 85 %(RH)

< In case of doubt >

Temperature: 20 °C ± 2 °C  
 Humidity: 60 %(RH) to 70 %(RH)  
 Atmospheric pressure: 86 kPa to 106 kPa

**5. Dimension**

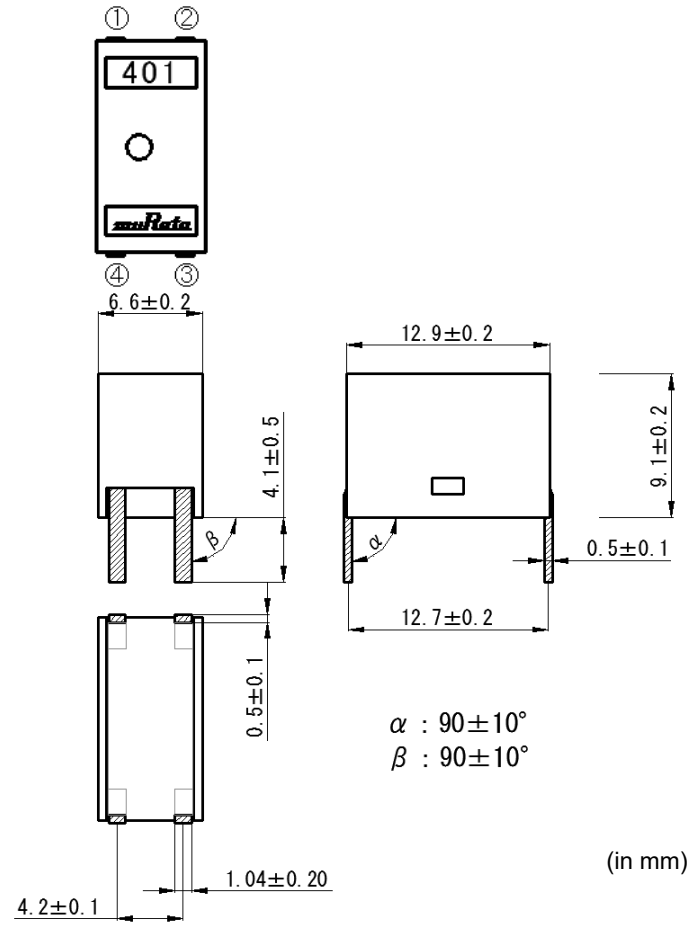

**■Equivalent Circuit**

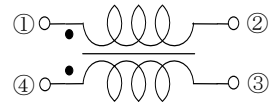

No Polarity

**■Unit Mass (Typical value)**

2.1g

: Electrode

**■Terminal Layout (Bottom Figure)**

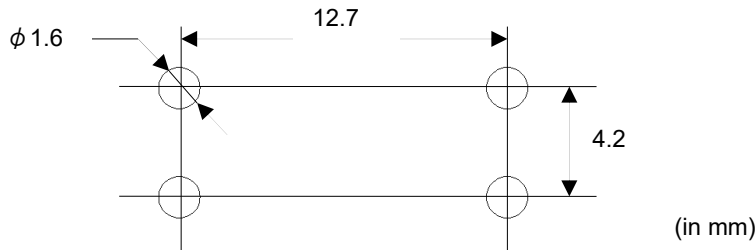

**6. Marking**

- (1)Manufacturer Identification : (*muRata*)
- (2)Parts Number : Common Mode Impedance Zc
  - PLT10HN401100P0B : ( **401** )
  - PLT10HN101150P0B : ( **101** )
  - PLT10HN450180P0B : ( **450** )

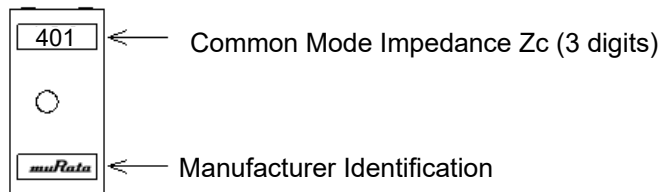

# Reference Only

## 7. Electrical Performance

No.	Item	Specification	Test method
7.1	Common Mode Impedance (Zc) Typ.	Meet item 3	Measuring Frequency: 10MHz (ref.item 10) Measuring Equipment: KEYSIGHT 4294A or the equivalent Use a cable / connector of 50Ω impedance.
7.2	Withstand Voltage	Products shall not be damaged.	Voltage: Rated Voltage×250% (ref.item 10) Time:1~5s Measuring current: 10mA max.
7.3	Insulation Resistance (I.R.)	Meet item 3	Voltage: Rated Voltage (ref.item 10) Time: 30s max. Measuring current: 10mA max Measuring Equipment: KEYSIGHT 4339A or the equivalent
7.4	DC Resistance (Rdc)	Meet item 3	Measuring method: four-terminal method (ref.item 10)
7.5	Inductance (L)	Meet item 3	Measuring Frequency:1±0.1kHz (ref.item 10) Voltage: 1V (rms) max. Measuring Equipment: KEYSIGHT 4284A or the equivalent

## 8. Mechanical performance

No.	Item	Specification	Test Method				
8.1	Appearance and Dimensions	Meet Item 5	Visual Inspection and measured with Slide Calipers.				
8.2	Marking	Marking is able to be read. (ref.item 5)	Visual Inspection				
8.3	Solderability	The electrodes shall be at least 90% covered with new solder coating.	Flux : Ethanol solution of rosin,25(wt)% Solder : Sn-3.0Ag-0.5Cu Pre-heating : 150°C±10°C, 60s Solder Temperature : 245°C±5°C Immersion Time : 3s±1s				
8.4	Resistance to soldering heat (Reflow)	Table 1 <table border="1" style="width: 100%; border-collapse: collapse;"> <tr> <td style="width: 50%;">Appearance</td> <td>No damage</td> </tr> <tr> <td>Inductance change (%ΔL)</td> <td>within ±15%</td> </tr> </table>	Appearance	No damage	Inductance change (%ΔL)	within ±15%	Solder : Sn-3.0Ag-0.5Cu Pre-heating: 150°C~180°C, 90s±30s Peak: 270°C±5°C, 10s Reflow times: 1 time
Appearance	No damage						
Inductance change (%ΔL)	within ±15%						
8.5	Vibration	<table border="1" style="width: 100%; border-collapse: collapse;"> <tr> <td style="width: 50%;">Insulation Resistance (I.R.)</td> <td>Meet item 3</td> </tr> <tr> <td>Withstand Voltage</td> <td>Products shall not be damaged.</td> </tr> </table>	Insulation Resistance (I.R.)	Meet item 3	Withstand Voltage	Products shall not be damaged.	It shall be soldered on the substrate. Oscillation Frequency: 10Hz to 2000Hz to 10Hz for 20 min Total Amplitude: 3.0mm or Acceleration amplitude 196 m / s <sup>2</sup> whichever is smaller. Testing Time: A period of 4 hours in each of 3 mutually perpendicular directions. (Total 12 h)
Insulation Resistance (I.R.)	Meet item 3						
Withstand Voltage	Products shall not be damaged.						

## 9. Environmental Performance

It shall be soldered on the substrate.

No.	item	specification	test method				
9.1	heat shock	Meet Table 2 <u>Table 2</u>	1 cycle : 1 step : -55 °C(+0 °C,-3 °C) / 30min(+3min,-0min) 2 step : 125 °C (+3°C,-0 °C) / 30min(+3min,-0min) Total of 100 cycles Then measured after exposure in the room condition for 48h± 4h.				
		<table border="1" style="width: 100%; border-collapse: collapse;"> <tr> <td style="width: 50%;">Appearance</td> <td style="width: 50%;">No damage</td> </tr> <tr> <td>Inductance change (% ΔL)</td> <td>Within ±20%</td> </tr> </table>		Appearance	No damage	Inductance change (% ΔL)	Within ±20%
		Appearance		No damage			
Inductance change (% ΔL)	Within ±20%						
<table border="1" style="width: 100%; border-collapse: collapse;"> <tr> <td style="width: 50%;">Insulation Resistance (I.R.)</td> <td style="width: 50%;">Meet item 3</td> </tr> <tr> <td>Withstand Voltage</td> <td>Products shall not be damaged.</td> </tr> </table>	Insulation Resistance (I.R.)	Meet item 3	Withstand Voltage	Products shall not be damaged.			
Insulation Resistance (I.R.)	Meet item 3						
Withstand Voltage	Products shall not be damaged.						
9.2	Humidity life		Temperature: 85°C±2°C Humidity : 80~85%(RH) Voltage: Rated Voltage Time: 1000+48/-0 h Then measured after exposure in the room condition for 48±4 h				
9.3	Heat life		125°C ±2 °C Voltage: Rated Voltage×200% Time: 1000+48/-0h Then measured after exposure in the room condition for 48±4 h				

## 10. Measuring Terminal

(When measuring and supplying the voltage, the following terminal is applied.)

No.	Item	Measuring terminal
10.1	Inductance (L) DC Resistance (Rdc)	
10.2	Withstand voltage Insulation Resistance (I.R.) Humidity life Heat life	
10.3	Common Mode Impedance(Zc)	

## 11. Measuring method for common mode impedance.

Measured common mode impedance may be included measurement error due to stray capacitance, residual inductance of test fixture.

To correct this error, the common mode impedance should be calculate as follows;

- (1) Measure admittance of the fixture(opened),  $G_o$   $B_o$ .
- (2) Measure impedance of the fixture(shorted),  $R_s$   $X_s$ .
- (3) Measure admittance of the specimen,  $G_m$   $B_m$ .
- (4) Calculate corrected impedance  $|Z|$  using the formula below.

$$|Z| = (R_x^2 + X_x^2)^{1/2}$$

Where

$$R_x = \frac{G_m - G_o}{(G_m - G_o)^2 + (B_m - B_o)^2} - R_s$$

$$X_x = \frac{-(B_m - B_o)}{(G_m - G_o)^2 + (B_m - B_o)^2} - X_s$$

## 12. P.C.B., Flux, Solder and Soldering condition

Test shall be done using P.C.B., Flux, Solder and Soldering condition which are specified in item 16 except the case of being specified special condition.

### 13. Common Mode Impedance (Zc) frequency characteristics (typical)

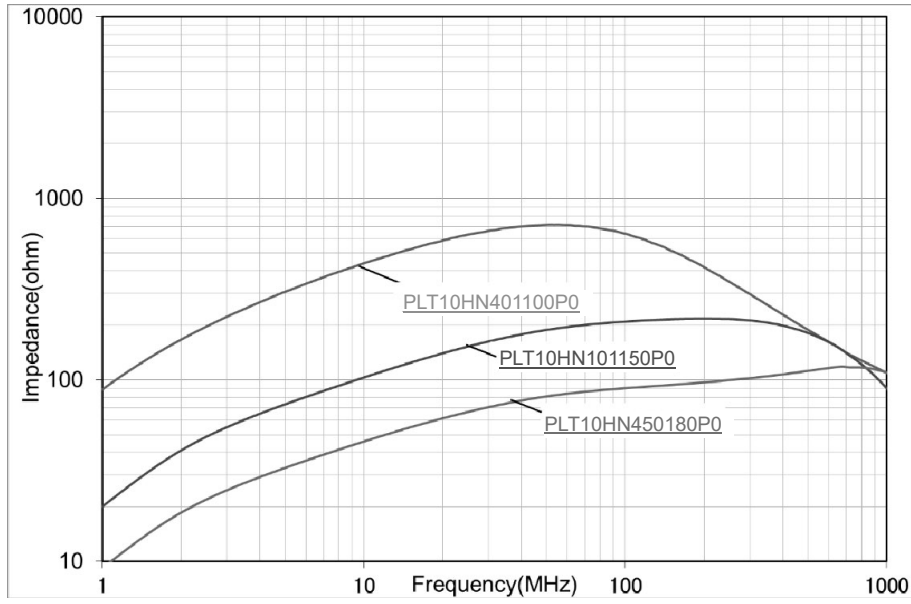

### 14. Specification of Packaging

#### 14.1 Packing Quantity

Individual packaging
100pcs

#### 14.2. Packing Method

IC foam of the stuck products on are placed in an Individual packaging.  
 A quantity in an Outer packaging is depending on a quantity of an order.



In some cases , omit the Buffer material and/or Currugated cardboard.



**16. Notice**

Products can only be soldered with reflow.  
 This product is designed for solder mounting.  
 Please consult us in advance for applying other mounting method such as conductive adhesive.

**16.1 Flux and Solder**

Flux	Use rosin-based flux. Do not use highly acidic flux (with chlorine content exceeding 0.2(wt)%) Do not use water soluble flux.
Solder	Use Sn-3.0Ag-0.5Cu solder

Other flux (except above) please contact us for details, then use.

**16.2 Soldering**

(1) Standard flow soldering profile.

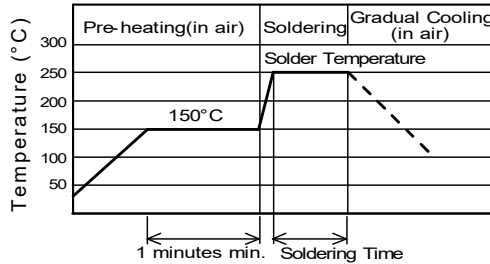

Solder Temperature	Soldering Time
250 ~ 260 °C	4 ~ 6 s

- (2) Resistance to soldering iron goes in the following condition that tip temperature is 350 °C max. and soldering time is 5 s max.
- (3) Products and the leads should not be subjected to any mechanical stress during soldering process. (and also while subjected to the equivalent high temperature.)

(1) Solder paste printing for reflow soldering

- Standard thickness of solder paste should be 150 to 200 μm.
- Incidentally, depending on the reflow condition and the way of heat conduction, the solder would not wet up the terminal, being possible to lead to not enough connection between terminals and lands on the circuit board / open circuit in the circuit board. In case of use, always evaluate this part in your products with actual use condition.
- For the solder paste printing pattern, use standard land dimensions.
- For the resist and copper foil pattern, use standard land dimensions.
- Use Sn-3.0Ag-0.5Cu solder

**16.3 Cleaning Conditions**

Products shall be cleaned on the following conditions.

- (1) Cleaning temperature shall be limited to 60 °C max. (40 °C max. for IPA.)
- (2) Ultrasonic cleaning shall comply with the following conditions, with avoiding the resonance phenomenon at the mounted products and P.C.B.  
 Power : 20W / l max.      Frequency : 28kHz to 40kHz      Time : 5 minutes max.
- (3) Cleaner
  - 1. Cleaner
    - Isopropyl alcohol (IPA)
  - 2. Aqueous agent
    - Higher Alcohol Type      (PINE ALPHA ST-100S)
- (4) There shall be no residual flux and residual cleaner after cleaning.  
 In the case of using aqueous agent, products shall be dried completely after rinse with de-ionized water in order to remove the cleaner.
- (5) The surface of products may become dirty whitely after cleaning.  
 But there is no deterioration on mechanical, electrical characteristics and reliability.
- (6) Other cleaning  
 Please contact us.

**16.4 Operating Environment**

Do not use this product under the following environmental conditions, on deterioration of the Insulation Resistance and/or corrosion of Inner Electrode may result from the use.

- (1) In the corrodible atmosphere (acidic gas, alkaline gas, chlorine, sulfur gas, organic gas and etc.)
- (2) In the atmosphere where liquid such as organic solvent, may splash on the products.
- (3) In the atmosphere where the temperature / humidity changes rapidly and it is easy to dew.
- (4) In the atmosphere where the product is covered with dust or is subjected to salty breeze.

## 16.5 Storage Conditions

### (1)Storage period

Use the products within 12 months after delivered.

Solderability should be checked if this period is exceeded.

### (2)Storage conditions

• Products should be stored in the warehouse on the following conditions.

Temperature: -10°C to 40°C

Humidity: 15% to 85% relative humidity

No rapid change on temperature and humidity

• Don't keep products in corrosive gases such as sulfur, chlorine gas or acid, or it may cause oxidization of electrode, resulting in poor solderability.

• Products should be stored on the palette for the prevention of the influence from humidity, dust and so on.

• Products should be stored in the warehouse without heat shock, vibration, direct sunlight and so on.

• Avoid storing the product by itself bare (i.e.exposed directly to air).

### (3)Delivery

Care should be taken when transporting or handling product to avoid excessive vibration or mechanical shock.

## 17. Note

(1)Please make sure that your product has been evaluated in view of your specifications with our product being mounted to your product.

(2)You are requested not to use our product deviating from the reference specifications.

(3)The contents of this reference specification are subject to change without advance notice.

Please approve our product specifications or transact the approval sheet for product specifications before ordering.