



53C350K

53 Series Industrial Potentiometer, Conductive Plastic Element, Solder lug Terminals, 2 W Power Rating, 50 kOhm Resistance Value

Representative photograph, actual product appearance may vary.

Due to regional agency approval requirements, some products may not be available in your area. Please contact your regional Honeywell office regarding your product of choice.

Features

- Robust nickel-plated brass shaft and bushings
- Conductive plastic element
- Linear taper
- 25,000 cycle rotational life

Typical Applications

- Manual controls (throttle, joystick)
- Electric vehicles
- Personal mobility
- Off-road vehicles
- Welding and heating
- Telecommunications

Description

The 53 Series is an economical potentiometer made with a rugged construction. It offers a 2 watt power rating and the benefits of a conductive plastic element. It is available in a special construction that accepts a rotary switch (purchased separately).



53C350K

53 Series Industrial Potentiometer, Conductive Plastic Element, Solder lug Terminals, 2 W Power Rating, 50 kOhm Resistance Value

Product Specifications	
Potentiometer Type	Industrial
Element Type	Conductive Plastic
Terminal Type	Solder lug
Power Rating	2 W
Resistance Value	50 kOhm
Resistance Tolerance	± 10 %
Linearity	± 5 %
Bushing Thread	9,53 mm [0.375 in] x 32 NEF-2A
Bushing length	9,53 mm [0.375 in]
Bushing Type	Standard
Shaft Diameter	6,35 mm [0.25 in]
Shaft length	22,23 mm [0.875 in]
Shaft Ending	Slotted
Body	27.8 mm [1.094 in] diameter max. except at terminal standoff
Electrical Taper	Linear
Operating Temperature	-55 °C to 120 °C [-67 °F to 248 °F]
Working Voltage (Max.)	500 V
Rotational Life	25000 cycles
Mechanical Rotation	312°
Availability	Global
Series Name	53 Series
UNSPSC Code	4111363300
UNSPSC Commodity	4111363300 Potentiometers

Honeywell

53C350K

53 Series Industrial Potentiometer, Conductive Plastic Element, Solder lug Terminals, 2 W Power Rating, 50 kOhm Resistance Value

For Reference Only

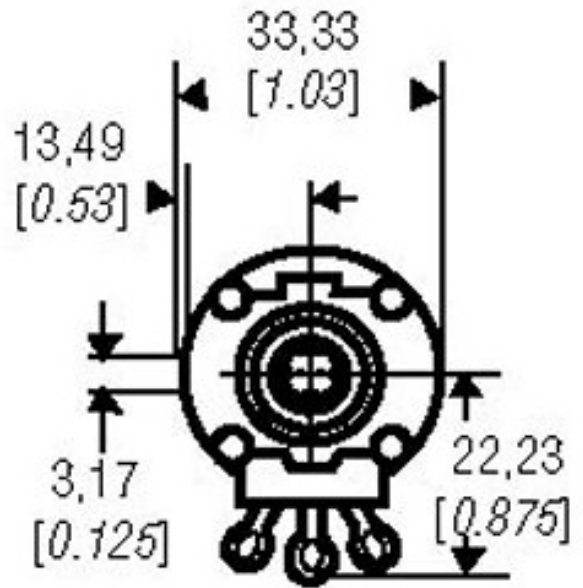
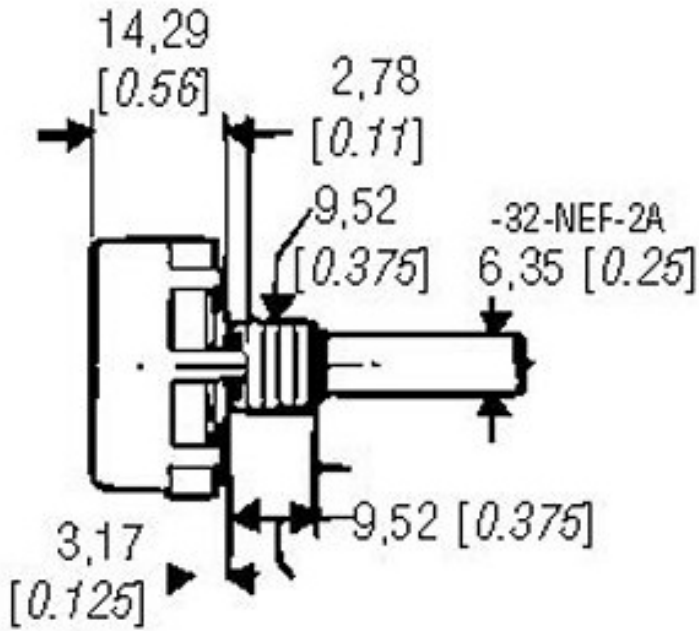

Honeywell

53C350K

53 Series Industrial Potentiometer, Conductive Plastic Element, Solder lug Terminals, 2 W Power Rating, 50 kOhm Resistance Value

⚠ WARNING

PERSONAL INJURY

DO NOT USE these products as safety or emergency stop devices, or in any other application where failure of the product could result in personal injury.

Failure to comply with these instructions could result in death or serious injury.

WARNING

MISUSE OF DOCUMENTATION

- The information presented in this product sheet (or catalog) is for reference only. DO NOT USE this document as product installation information.
- Complete installation, operation and maintenance information is provided in the instructions supplied with each product.

Failure to comply with these instructions could result in death or serious injury.

© Copyright Honeywell Inc. 1998-2004 All rights reserved.