

ISL8277MEVAL1Z

User's Manual: Evaluation Board

Industrial Analog and Power

ISL8277MEVAL1Z

Evaluation Board

UG115
Rev.0.00
Jul 28, 2017

1. Overview

The [ISL8277M](#) is a 25A step-down DC/DC power supply module with an integrated digital PWM controller, synchronous power switches, an inductor, and passives. Only bulk input and output capacitors are needed to finish the design. The 25A of continuous output current can be delivered without the need for airflow or a heatsink. The ISL8277M uses ChargeMode™ control architecture, which responds to a transient load within a single switching cycle.

The ISL8277MEVAL1Z evaluation board is a 3inx4.5in 4-layer FR4 board with 2oz. copper in all layers. This evaluation board comes with a placeholder for pin-strap resistors to adjust output voltage, switching frequency, input Undervoltage Lockout (UVLO) protection threshold, and device PMBus address. More configuration such as soft-start and fault limits can be easily programmed or changed via a PMBus compliant serial bus interface.

The ZLUSBEVAL3Z (USB to PMBus adapter) is provided with this evaluation board, which connects the evaluation board to a PC to activate the PMBus communication interface. The PMBus command set is accessed by using the PowerNavigator™ evaluation software from a PC running Microsoft Windows.

1.1 Key Features

- V_{IN} range of 4.5V to 14V, V_{OUT} adjustable from 0.6V to 5V
- Programmable V_{OUT} , margining, UV/OV, I_{OUT} limit, soft-start/stop, sequencing, and external synchronization
- Monitor: V_{IN} , V_{OUT} , I_{OUT} , temperature, duty cycle, switching frequency, and faults
- ChargeMode control tunable with PMBus
- Mechanical switch for enable and power-good LED indicator

1.2 Specifications

This board has been configured and optimized for the following operating conditions:

- $V_{IN} = 5V$ to 12V
- $V_{OUT} = 1.2V$
- $I_{MAX} = 25A$
- $f_{SW} = 533kHz$
- Peak efficiency: >91% at 50% load
- ASCR gain = 250, ASCR residual = 90
- On/off delay = 5ms, On/off ramp time = 5ms

1.3 Ordering Information

Part Number	Description
ISL8277MEVAL1Z	ISL8277M evaluation board (also included: ZLUSBEVAL3Z adapter, USB cable)

1.4 Related Literature

- For a full list of related documents, visit our website
- [ISL8277M](#) product page

1.5 Recommended Equipment

- DC power supply with minimum 15V/20A sourcing capacity
- Electronic load capable of sinking current up to 25A
- Digital multimeters (DMMs)
- Oscilloscope with higher than 100MHz bandwidth

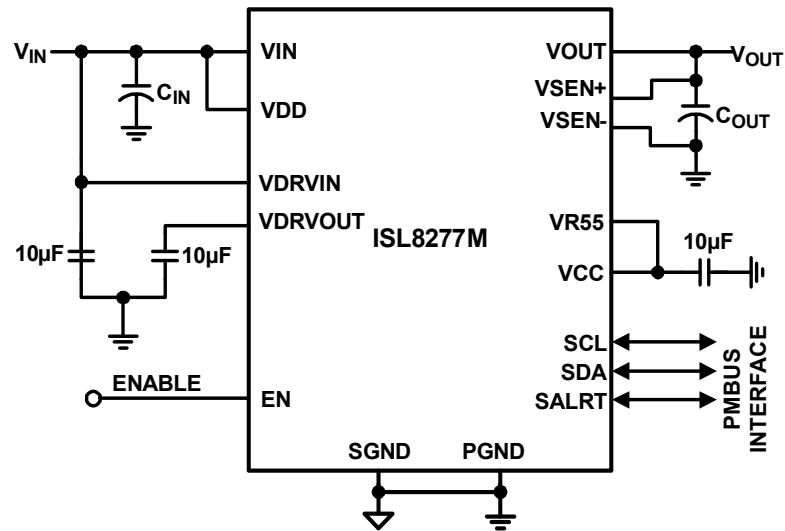

Figure 1. Block Diagram

2. Functional Description

The ISL8277MEVAL1Z provides all circuitry required to evaluate the features of the ISL8277M. A majority of the features of the ISL8277M, such as compensation-free ChargeMode control, soft-start delay and ramp times, supply sequencing, and voltage margining are available on this evaluation board. For sequencing evaluation, the board can be connected to any Intersil digital module evaluation board that supports the Digital-DC™ (DDC) bus.

[Figure 2 on page 7](#) shows an image of the ISL8277MEVAL1Z evaluation board.

2.1 Operating Range

By default, the ISL8277MEVAL1Z is configured to operate at $V_{OUT} = 1.2V$, $f_{SW} = 533kHz$. V_{IN} ranges are from 4.5V to 12V. The board can also support a wider operating range to meet the requirements of specific applications. The V_{OUT} can be adjusted from 0.6V to 5V. Load current range is from 0A to 25A. Note that, for continuous operation at 25A, airflow across the board may be needed. The f_{SW} and output voltage can also be tuned. However, to ensure sufficient stability margins, switching frequency and output capacitors can only be selected using the “ISL8277M Design Guide Matrix and Output Voltage Response” table in the [ISL8277M](#) datasheet.

If input voltage is less than 5.3V, tie the VCC test point directly to VIN or to a separate 5V power supply for normal operation and best efficiency.

The ISL8277MEVAL1Z is capable of handling a 0A to 25A output current transient, in which the slew rate is less than 2A/ μs , such as electronic load. If the slew rate exceeds the 2A/ μs , then it may be necessary to increase the output capacitance or change VOUT_OV_FAULT_LIMIT and VOUT_UV_FAULT_LIMIT values for proper operation (refer to [“PMBus Option” on page 5](#)).

If external synchronization is used, connect the SYNC test point to the external clock. Note that the external clock signal should be active before the module is enabled.

2.2 PMBus Operation

The ISL8277M uses the PMBus protocol. The PMBus functionality can be controlled through the ZLUSBEVAL3Z dongle from a PC running the PowerNavigator evaluation software on Windows XP or Windows 7 operating systems.

Install the evaluation software from the website: www.intersil.com/powernavigator

For board operation, connect the included ZLUSBEVAL3Z dongle to the 6-pin male connector labeled as “PMBus DONGLE IN”. Connect the desired load and an appropriate power supply to the input and connect the included USB cable to the PC running the PowerNavigator evaluation software. Set the ENABLE switch to “DISABLE” before turning on the power.

The evaluation software allows modification of all ISL8277M PMBus parameters. The ISL8277M device on the board has been preconfigured as described in this document, but the user can modify the operating parameters through the evaluation software or by loading a predefined set-up from a configuration file. A sample [“Configuration File” on page 13](#) is provided and can be copied to a text editor to make desired changes.

The ENABLE switch can then be moved to “ENABLE” and the ISL8277MEVAL1Z board can be tested. Alternately, the PMBus ON_OFF_CONFIG and OPERATION commands can be used from the PowerNavigator GUI.

2.3 Quick Start Guide

2.3.1 Pin-Strap Option

ISL8277MEVAL1Z can be configured in Pin-Strap mode with standard 1% 0603 resistors. The PMBus interface is not required to evaluate ISL8277M in Pin-Strap mode. Output voltage (V_{OUT}), switching frequency (f_{SW}), input undervoltage protection (UVLO) threshold, and the device PMBus address can be changed by populating the recommended resistors at placeholders provided in the evaluation board. By default, the evaluation board is programmed to regulate at $V_{OUT} = 1.2V$, $f_{SW} = 533kHz$, $UVLO = 4.5V$, and PMBus address = 28h. Follow these steps to evaluate ISL8277M in Pin-Strap mode.

- (1) Set the ENABLE switch to “DISABLE”.
- (2) Connect a load to the VOUT lug connectors (J8 and J9).
- (3) Connect a power supply to the VIN connectors (J1 and J2). Make sure the power supply is not enabled when making the connection.
- (4) Turn the power supply on.
- (5) Set the ENABLE switch to “ENABLE”.
- (6) Measure 1.2V V_{OUT} at probe points TP9 and TP13.
- (7) Observe switching frequency of 533kHz at probe point labeled VSWH (TP8).
- (8) To change the V_{OUT} , disconnect the board from the setup and populate with a 1% standard 0603 resistor at R_6 placeholder location on bottom layer. Refer to the “Output Voltage Resistor Settings” table in the [ISL8277M](#) datasheet for recommended values. By default, V_{OUT_MAX} is set 110% of V_{OUT} set by pin-strap resistor.
- (9) To change the switching frequency, disconnect the board from the set up and populate with a 1% standard 0603 resistor at R_2 placeholder location on bottom layer. Refer to the “Switching Frequency Resistor Settings” table in the [ISL8277M](#) datasheet for recommended values.
- (10) To change the UVLO, disconnect the board from the set up and populate with a 1% standard 0603 resistor at R_7 placeholder location on bottom layer. Refer to the “UVLO Resistor Settings” table in the [ISL8277M](#) datasheet for recommended values.

2.3.2 PMBus Option

ISL8277MEVAL1Z can be evaluated for all features using the provided ZLUSBEVAL3Z dongle and PowerNavigator evaluation software. Follow these steps to evaluate ISL8277M with the PMBus option.

- (1) Install the PowerNavigator software.
- (2) Set the ENABLE switch to “DISABLE”.
- (3) Connect a load to the VOUT lug connectors (J8 and J9).
- (4) Connect a power supply to the VIN connectors (J1 and J2). Make sure the power supply is not enabled when making the connection.
- (5) Turn the power supply on.
- (6) Connect the ZLUSBEVAL3Z dongle (USB to PMBus adapter) to ISL8277MEVAL1Z board to the 6-pin male connector labeled as “PMBus DONGLE IN”.
- (7) Connect the supplied USB cable from the computer through USB to the ZLUSBEVAL3Z dongle.
- (8) Launch the PowerNavigator software.
- (9) Set the ENABLE switch to “ENABLE”.
- (10) Monitor and configure the ISL8277MEVAL1Z board using PMBus commands in the evaluation software.
- (11) PowerNavigator tutorial videos are available at Intersil website. www.intersil.com/powernavigator
- (12) For sequencing via Digital-DC Bus (DDC) or to evaluate multiple Intersil digital power products using a single ZLUSBEVAL3Z dongle, ISL8277M can be daisy chained with other digital power evaluation boards. The PMBus address can be changed by placing a 1% standard 0603 resistor at the R_5 placeholder location on the bottom layer. Refer to the “SMBus Address Resistor Selection” table in the [ISL8277M](#) datasheet for recommended values.

3. PCB Layout Guidelines

To achieve stable operation, low losses, and good thermal performance some layout considerations are necessary.

The key features of the ISL8277MEVAL1Z layout are:

- Establish separate SGND plane and PGND plane, then connect SGND to PGND plane in the middle layer. For making connections between SGND/PGND on the top layer and other layers, use multiple vias for each pin to connect to inner SGND/PGND layer. Do not connect SGND directly to PGND on a top layer. Connecting SGND directly to PGND without establishing SGND plane will bypass the decoupling capacitor at internal reference supplies, making controller susceptible to noise.
- Place enough ceramic capacitors between VIN and PGND, VOUT and PGND, and bypass capacitors between VDD and the ground plane, as close to the module as possible to minimize high frequency noise.
- Use large copper areas for power path (VIN, PGND, and VOUT) to minimize conduction loss and thermal stress. Also, use multiple vias to connect the power planes in different layers. Extra ceramic capacitors at VIN and VOUT can be placed on the bottom layer under VIN and VOUT pads when multiple vias are used for connecting copper pads on top and bottom layers.
- Connect differential remote sensing traces to the regulation point to achieve a tight output voltage regulation. Route a trace from VSEN+ and VSEN- to the point-of-load where the tight output voltage is desired. Avoid routing any sensitive signal traces, such as the VSENSE signal near VSWH pads.
- For noise sensitive applications, it is recommended to connect VSWH pads only on the top layer; however, thermal performance will be sacrificed. External airflow might be required to keep module heat at desired level. For applications where switching noise is less critical, excellent thermal performance can be achieved in this power module by increasing the copper mass attached to the VSWH pad. To increase copper mass on the VSWH node, create copper islands in the middle and bottom layers under the VSWH pad and connect them to the top layer with multiple vias. Make sure to shield those copper islands with a PGND layer to avoid any interference to noise sensitive signals.

3.1 Thermal Considerations and Current Derating

Board layout is very critical to make the module operate safely and deliver maximum allowable power. To work in high temperature environments and carry large currents, the board layout needs to be carefully designed to maximize thermal performance. To achieve this, select enough trace width, copper weight, and the proper connectors.

This evaluation board is designed for running 25A at room temperature without additional cooling systems needed. However, if the output voltage is increased or the board is operated at elevated temperatures, then the available current is derated. Refer to the derated current curves in the [ISL8277M](#) datasheet to determine the maximum output current the evaluation board can supply. θ_{JA} is measured by inserting thermocouple inside the module to measure peak junction temperature.

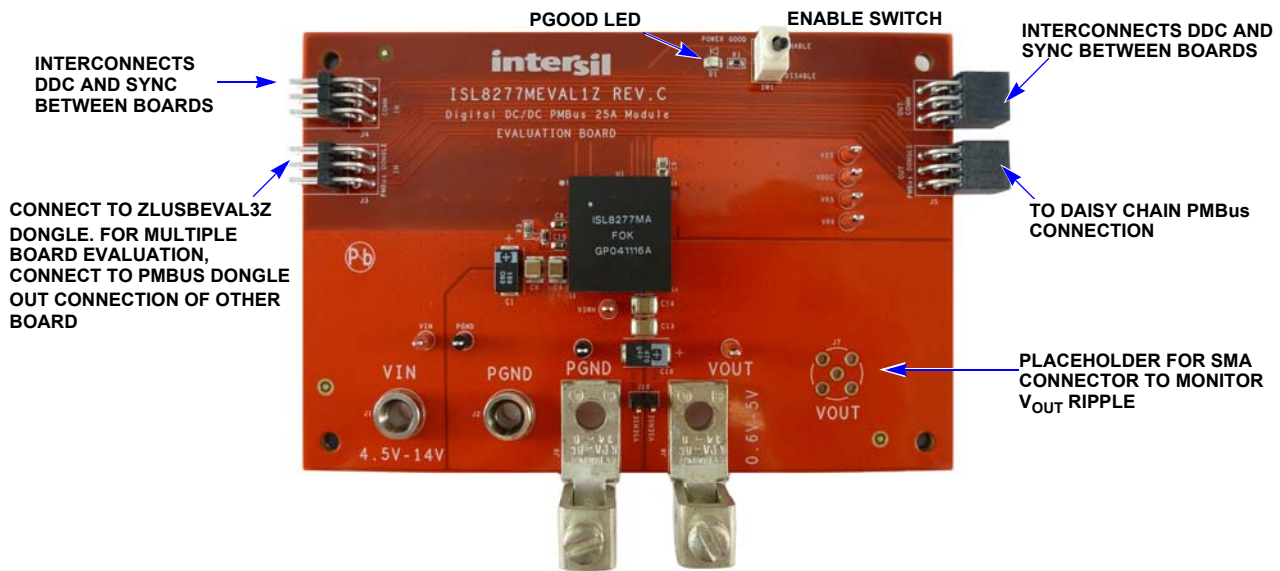

Figure 2. ISL8277MEVAL1Z Evaluation Board (Top Side)



Figure 3. ISL8277MEVAL1Z Evaluation Board (Bottom Side)

3.3 Bill of Materials

Qty	Reference Designator	Description	Manufacturer	Manufacturer Part
1		PWB-PCB, ISL8277MEVAL1Z, REVC, ROHS	SHENZHEN MULTILAYER PCB TECHNOLOGY CO., LTD	ISL8277MEVAL1ZREVCPCB
3	C4, C5, C6	CAP, SMD, 1210, 22 μ F, 25V, 10%, X7R, ROHS	MURATA	GRM32ER71E226KE15L
1	C17	CAP, SMD, 0402, 1 μ F, 6.3V, 10%, X5R, ROHS	PANASONIC	ECJ-0EB0J105K
2	C7, C8	CAP, SMD, 0603, 10 μ F, 16V, 10%, X5R, ROHS	MURATA	GRM188R61C106KAALD
1	C10	CAP, SMD, 0603, 4.7 μ F, 16V, 10%, X5R, ROHS	VENKEL	C0603X5R160-475KNE
0	C3	CAP, SMD, 0603, DNP-PLACE HOLDER, ROHS		
1	C9	CAP, SMD, 0805, 10 μ F, 25V, 10%, X5R, ROHS	TDK	C2012X5R1E106K
4	C11, C12, C13, C14	CAP, SMD, 1210, 100 μ F, 6.3V, 10%, X5R, ROHS	AVX	12106D107KAT2A
2	C1, C2	CAP-POSCAP, SMD, 7.3x4.3, 150 μ F, 16V, 20%, 50m Ω , ROHS	SANYO/PANASONIC	16TQC150MYF
2	C15, C16	CAP-POSCAP, SMD, 7.3x4.3, 470 μ F, 4V, 20%, 12m Ω , ROHS	PANASONIC/SANYO	4TPE470MCL
7	TP1, TP4-TP9	CONN-MINI TEST PT, VERTICAL, RED, ROHS	KEYSTONE	5000
2	TP2, TP13	CONN-MINI TEST PT, VERTICAL, BLK, ROHS	KEYSTONE	5001
2	J1, J2	CONN-JACK, MINI BANANA, 0.175 PLUG, NICKEL/BRASS, ROHS	KEYSTONE	575-4
1	J10	CONN-HEADER, 1x2, BRKAWY 1x36, 2.54mm, ROHS	BERG/FCI	68000-236HLF
2	J5, J6	CONN-SOCKET STRIP, TH, 2x3, 2.54mm, TIN, R/A, ROHS	SAMTEC	SSQ-103-02-T-D-RA
2	J3, J4	CONN-HEADER, 2x3, BRKAWY, 2.54mm, TIN, R/A, ROHS	SAMTEC	TSW-103-08-T-D-RA
1	D1	LED, SMD, 0805, GREEN, CLEAR, 10mcd, 2.1V, 20mA, 570nm, ROHS	CHICAGO MINIATURE	CMD17-21VGC/TR8
1	U1	IC-25A DC/DC, PWR MODULE, 40P, HDA, 17x19, ROHS	INTERSIL	ISL8277MAIRZ
1	Q1	TRANSISTOR, N-CHANNEL, 3LD, SOT-23, 60V, 115mA, ROHS	DIODES, INC.	2N7002-7-F
0	R2, R5, R6, R7, R8	RESISTOR, SMD, 0603, 0.1%, MF, DNP-PLACE HOLDER		
4	R3, R9, R10, R14	RES, SMD, 0603, 0 Ω , 1/10W, TF, ROHS	VENKEL	CR0603-10W-000T
1	R12	RES, SMD, 0603, 1k, 1/10W, 1%, TF, ROHS	PANASONIC	ERJ-3EKF1001V
2	R1, R11	RES, SMD, 0603, 10k, 1/10W, 1%, TF, ROHS	VENKEL	CR0603-10W-1002FT
1	R4	RES, SMD, 0603, 4.7k, 1/10W, 1%, TF, ROHS	YAGEO	9C06031A4701FKHFT
1	R15	RES, SMD, 0603, 4.99k, 1/10W, 1%, TF, ROHS	PANASONIC	ERJ-3EKF4991V
1	R13	RES, SMD, 1206, 200 Ω , 1/4W, 1%, TF, ROHS	PANASONIC	ERJ-8ENF2000V
1	SW1	SWITCH-TOGGLE, THRU-HOLE, SPDT, 5P, ROHS	ITT CANNON	GT11MCBE
2	J8, J9	HWWARE, MTG, CABLE TERMINAL, 6-14AWG, LUG&SCREW, ROHS	BERG/FCI	KPA8CTP

Qty	Reference Designator	Description	Manufacturer	Manufacturer Part
4	BOTTOM FOUR CORNERS	BUMPONS, 0.44inW x 0.20inH, DOMETOP, BLACK	3M	SJ-5003SPBL
1	PLACE ASSY IN BAG	BAG, STATIC, 5x8, ZIPLOC, ROHS	INTERSIL	212403-013
0	J7	DO NOT POPULATE OR PURCHASE		
1	AFFIX TO BACK OF PCB	LABEL-DATE CODE_LINE 1: YRWK/REV#, LINE 2: BOM NAME	INTERSIL	LABEL-DATE CODE

3.4 ISL8277MEVAL1Z Board Layout

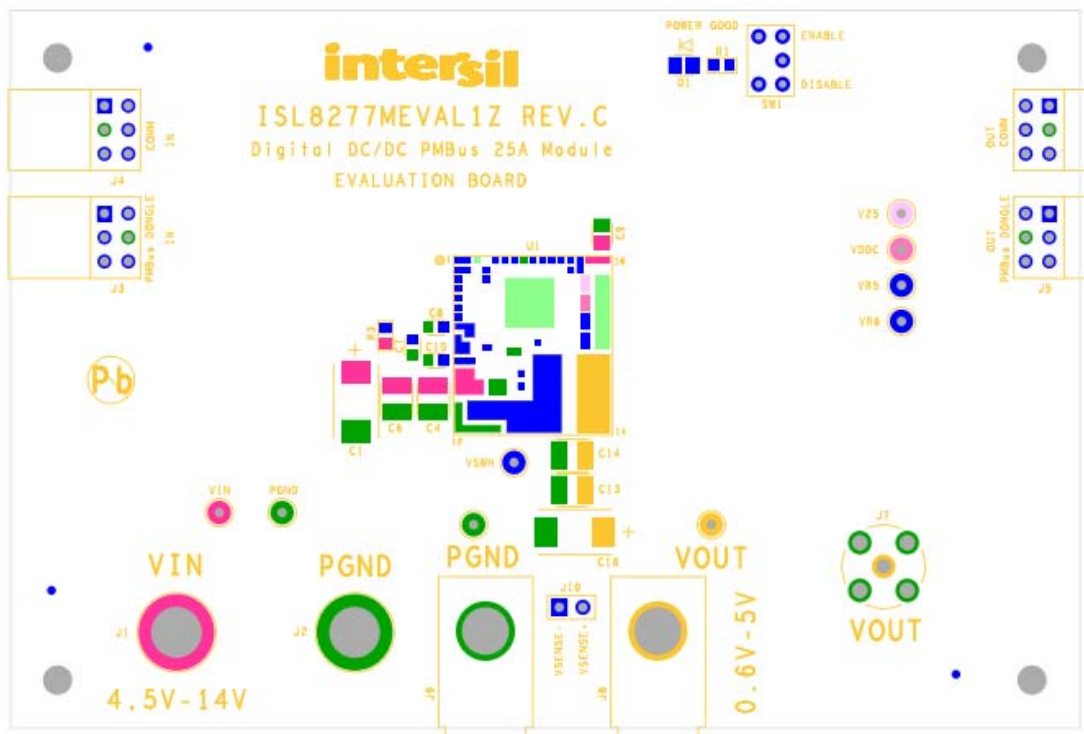

Figure 5. PCB - Top Silk Screen

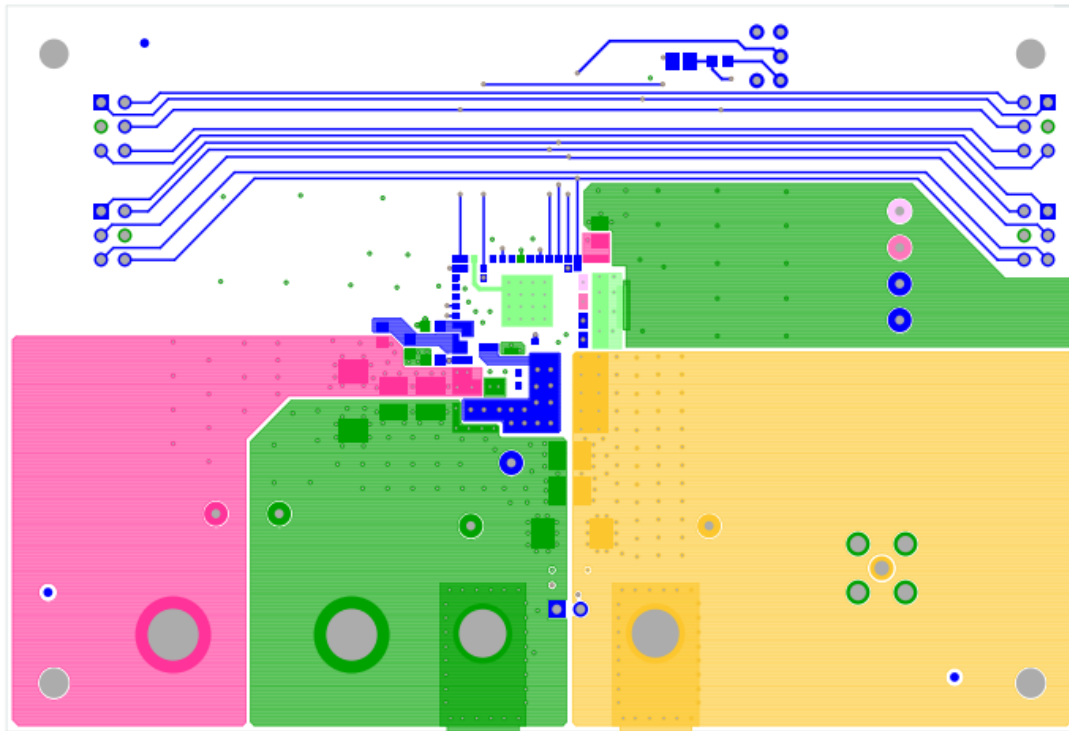

Figure 6. PCB - Top Layer

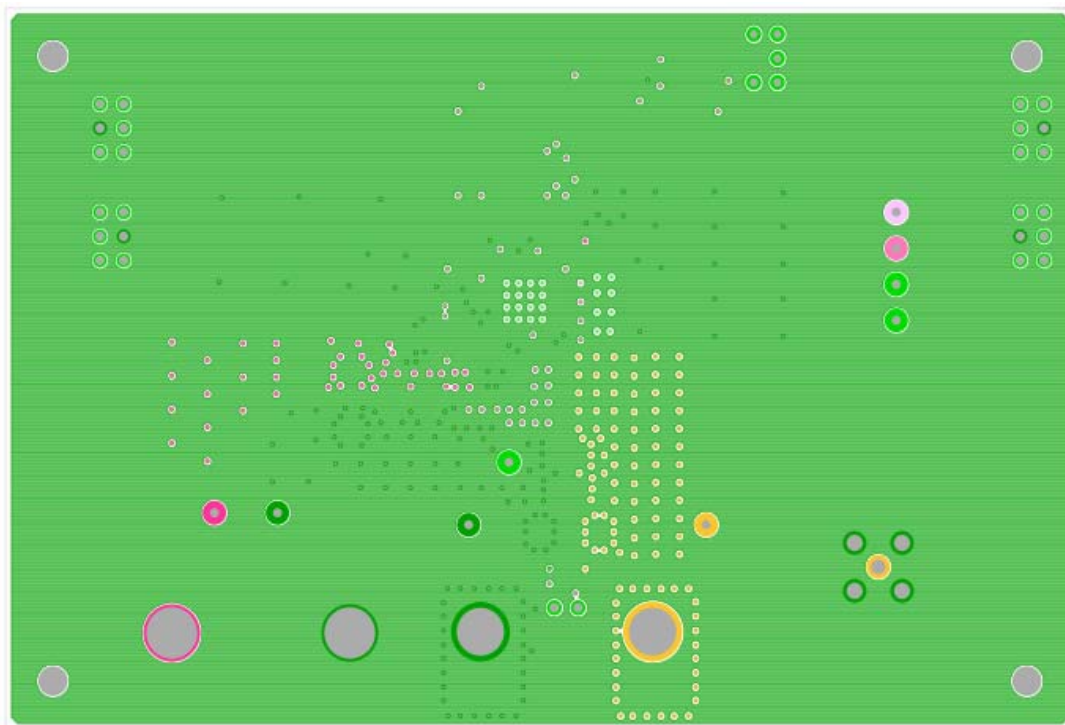

Figure 7. PCB - Inner Layer - Layer 2 (Top View)

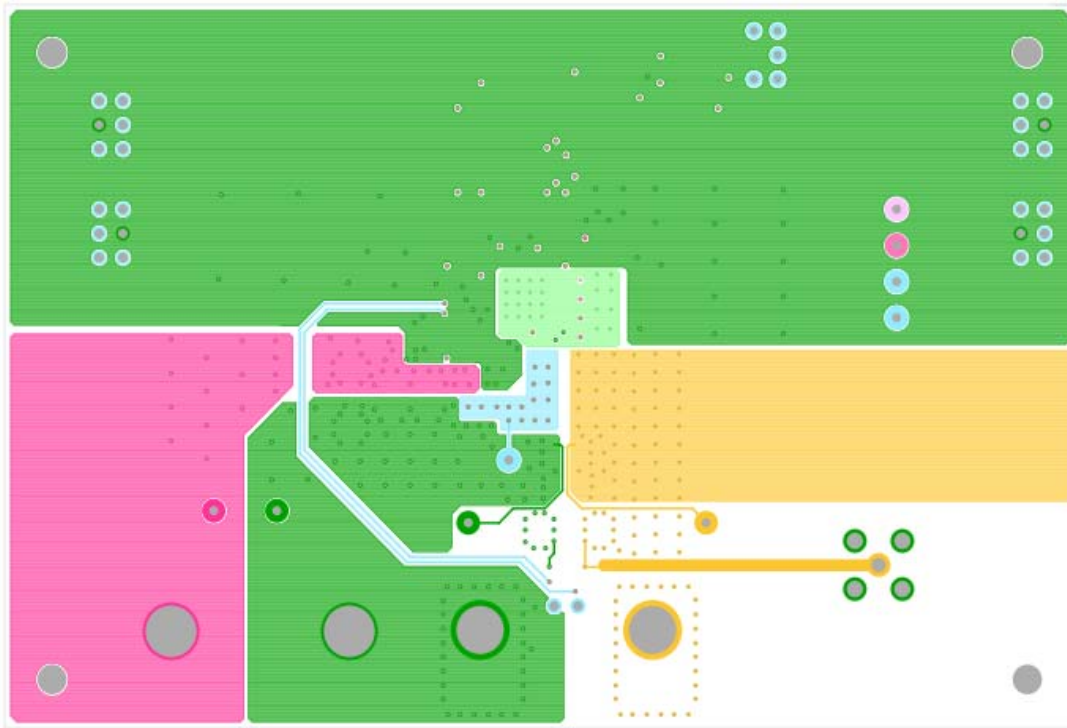

Figure 8. PCB - Inner Layer - Layer 3 (Top View)

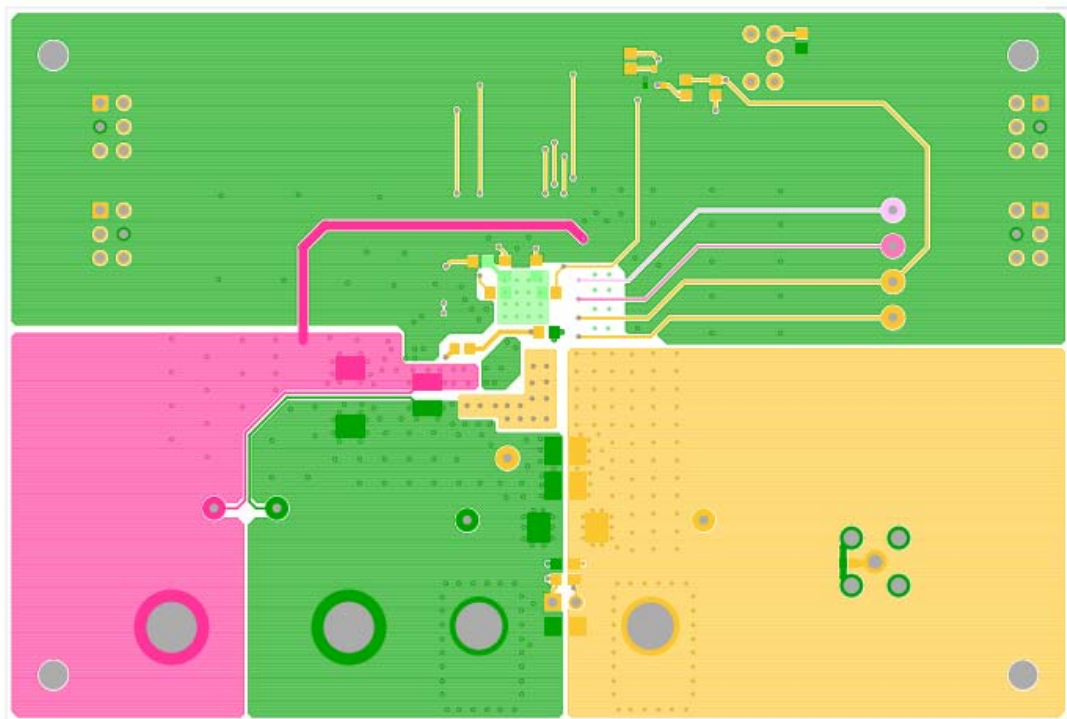

Figure 9. PCB - Bottom Layer (Bottom View)

4. Configuration File

Sample configuration file for the ISL8277M module. Copy and paste (from RESTORE_FACTORY TO ### End User Store) to a text editor and save it as Confile_file_name.txt. The # symbol is used for a comment line. The following settings are already loaded to ISL8277M module as factory defaults.

```

RESTORE_FACTORY
STORE_USER_ALL
### Begin User Store
RESTORE_USER_ALL
ON_OFF_CONFIG          0x1A
VOUT_COMMAND           0x2666          # 1.2 V
VOUT_CAL_OFFSET        0x0000          # 0 V
VOUT_MAX                0x2A3C          # 1.32 V
VOUT_MARGIN_HIGH       0x2851          # 1.26 V
VOUT_MARGIN_LOW        0x247A          # 1.14 V
VOUT_TRANSITION_RATE   0xBA00          # 1 mV/us
VOUT_DROOP              0x0000          # 0 mV/A
INTERLEAVE             0x0000
IOUT_CAL_GAIN           0xB380          # 0.875 mV/A
IOUT_CAL_OFFSET        0x0000          # 0 A
VOUT_OV_FAULT_LIMIT    0x2C28          # 1.38 V
VOUT_OV_FAULT_RESPONSE 0x80
VOUT_OV_WARN_LIMIT     0x2A3C          # 1.32 V
VOUT_UV_FAULT_LIMIT    0x20A3          # 1.02 V
VOUT_UV_FAULT_RESPONSE 0x80
VOUT_UV_WARN_LIMIT     0x228F          # 1.08 V
IOUT_OC_FAULT_LIMIT    0xDBC0          # 30 A
IOUT_UC_FAULT_LIMIT    0xDC3F          # -30.031 A
OT_FAULT_LIMIT         0xEBE8          # 125 °C
OT_FAULT_RESPONSE      0x80
OT_WARN_LIMIT          0xEB70          # 110 °C
UT_WARN_LIMIT          0xDC40          # -30 °C
UT_FAULT_LIMIT         0xE530          # -45 °C
UT_FAULT_RESPONSE      0x80
POWER_GOOD_ON          0x228F          # 1.08 V
TON_DELAY              0xCA80          # 5 ms
TON_RISE               0xCA80          # 5 ms
TOFF_DELAY             0xCA80          # 5 ms
TOFF_FALL              0xCA80          # 5 ms
ISENSE_CONFIG          0x05
USER_CONFIG            0x00
DDC_CONFIG             0x08          # 8 null
POWER_GOOD_DELAY       0xCA00          # 4 ms
ASCR_CONFIG            0x015A00FA      # ASCR Gain=250, Residual=90
SEQUENCE               0x0000
TRACK_CONFIG           0x00
DDC_GROUP              0x00000000
LEGACY_FAULT_GROUP    0x00000000          # 0 null
MFR_IOUT_OC_FAULT_RESPONSE 0x80
MFR_IOUT_UC_FAULT_RESPONSE 0x80
MFR_VMON_OV_FAULT_LIMIT 0xCB00          # 6 V
MFR_VMON_UV_FAULT_LIMIT 0xCA00          # 4 V
FREQUENCY_SWITCH       0x0215          # 533 kHz
VIN_OV_FAULT_LIMIT     0xD3A0          # 14.5 V
VIN_OV_FAULT_RESPONSE  0x80
VIN_OV_WARN_LIMIT     0xD343          # 13.047 V
VIN_UV_WARN_LIMIT     0xCA79          # 4.945 V
VIN_UV_FAULT_LIMIT     0xCA40          # 4.5 V
VIN_UV_FAULT_RESPONSE  0x80
MFR_ID
MFR_MODEL
MFR_REVISION
MFR_LOCATION
MFR_DATE
MFR_SERIAL
USER_DATA_00
DDC_ENG                0x0A5A
SYNC_CONFIG            0x00
STORE_USER_ALL
### End User Store

```

5. Measured Data

The following data was acquired using an ISL8277MEVAL1Z evaluation board.

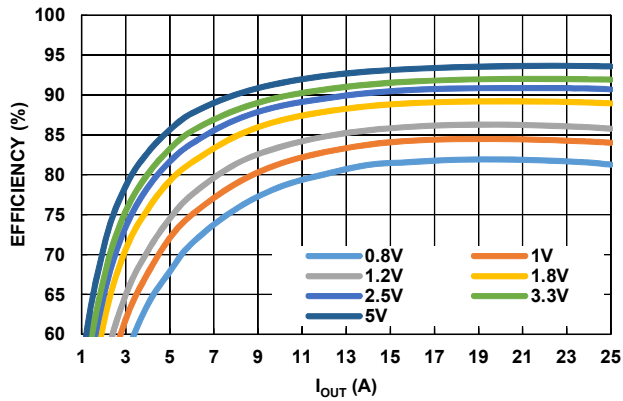

Figure 10. Efficiency vs Output Current at $V_{IN} = 12V$, $f_{SW} = 533kHz$ for Various Output Voltages

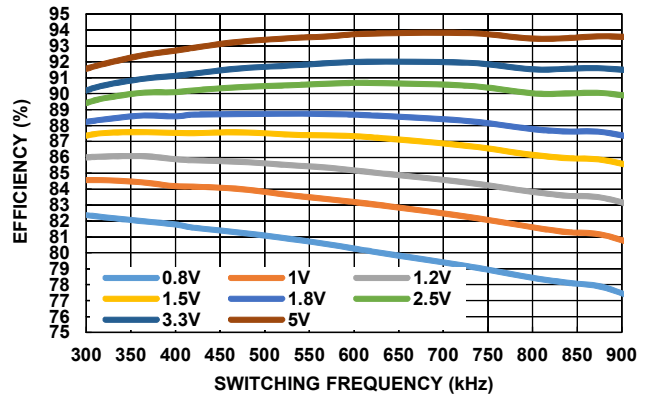

Figure 11. Efficiency vs Switching Frequency at $V_{IN} = 12V$, $I_{OUT} = 25A$ for Various Output Voltages

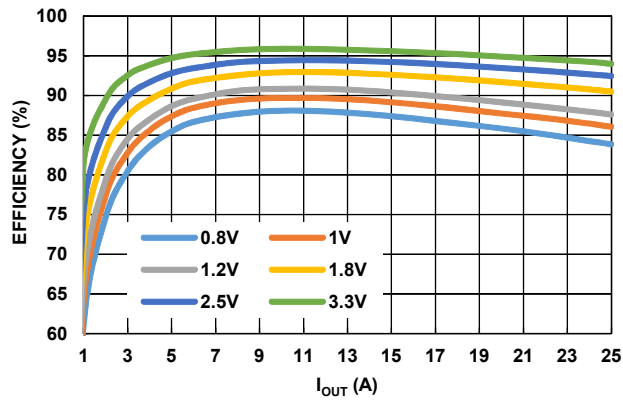

Figure 12. Efficiency vs Output Current at $V_{IN} = 5V$, $f_{SW} = 533kHz$ for Various Output Voltages

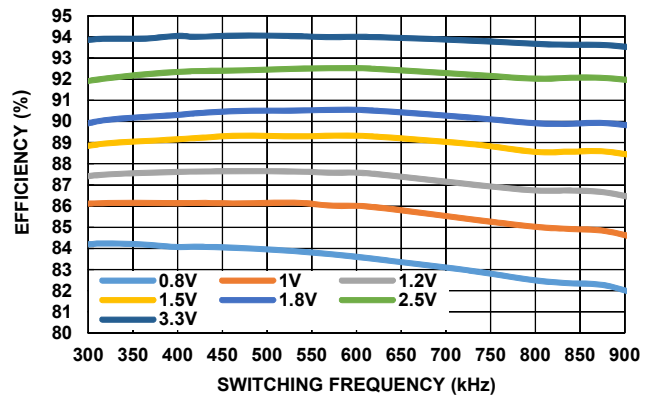

Figure 13. Efficiency vs Switching Frequency at $V_{IN} = 5V$, $I_{OUT} = 25A$ for Various Output Voltages

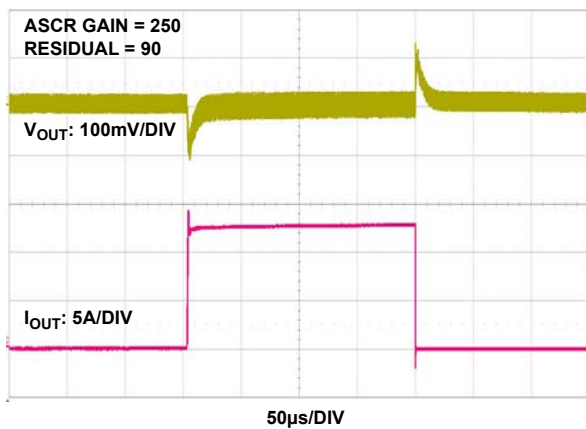

Figure 14. $12V_{IN}$ to $1.2V_{OUT}$ Transient Response, $f_{SW} = 533kHz$, $C_{OUT} = 4x100µF$ Ceramic + $2x470µF$ POSCAP

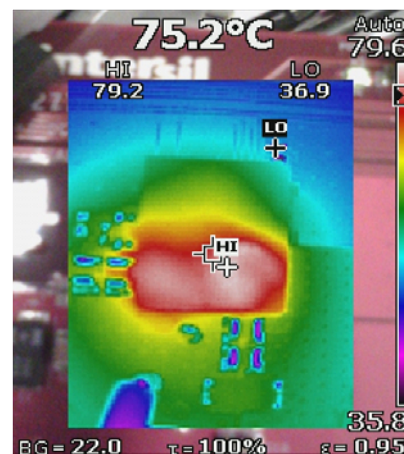

Figure 15. Thermal Image, $12V_{IN}$ to $1V_{OUT}$, $I_{OUT} = 25A$, $T_A = 25°C$, $f_{SW} = 550kHz$, No Air Flow

6. Revision History

Rev.	Date	Description
0.00	Jul 28, 2017	Initial release

© Copyright Intersil Americas LLC 2017. All Rights Reserved.
All trademarks and registered trademarks are the property of their respective owners.

Intersil Corporation reserves the right to make changes in circuit design, software and/or specifications at any time without notice. Accordingly, the reader is cautioned to verify that the document is current before proceeding.

For information regarding Intersil Corporation and its products, see www.intersil.com

ISL8277MEVAL1Z