

### ■回路図 CIRCUIT

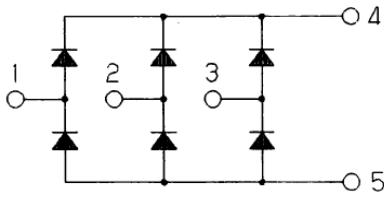

### ■外形寸法図 OUTLINE DRAWING

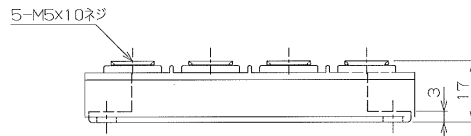
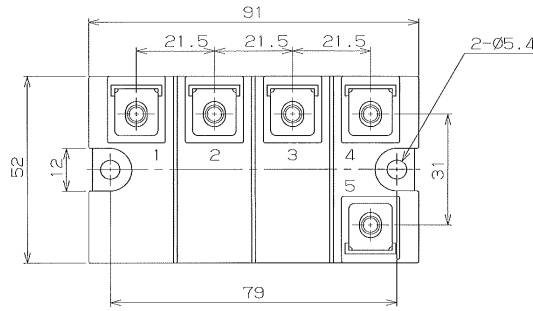

Dimension: [mm]

### ■最大定格 Maximum Ratings

項目 Parameter	記号 Symbol	耐圧クラス Grade		単位 Unit
		PT100KN16		
くり返しピーク逆電圧 Repetitive Peak Reverse Voltage	*1 V <sub>RRM</sub>	1600		V
非くり返しピーク逆電圧 Non Repetitive Peak Reverse Voltage	*1 V <sub>RSM</sub>	1700		V

項目 Parameter	記号 Symbol	条件 Conditions	定格値 Max. Rated Value	単位 Unit	
平均出力電流 Average Rectified Output Current	I <sub>O(AV)</sub>	三相全波整流 3-Phase Full Wave Rectified T <sub>c</sub> =T <sub>t</sub> =125°C (T <sub>c</sub> : 測定点チップ直下 / T <sub>t</sub> : Terminal)	100	A	
サージ順電流 Surge Forward Current	*1 I <sub>FSM</sub>	50Hz 正弦半波, 1サイクル, 非くり返し Half Sine Wave, 1Pulse, Non-Repetitive	1200	A	
電流二乗時間積 I Squared t	*1 I <sup>2</sup> t	2~10ms	7200	A <sup>2</sup> s	
動作接合温度範囲 Operating Junction Temperature Range	T <sub>jw</sub>		-40 ~ +150	°C	
保存温度範囲 Storage Temperature Range	T <sub>stg</sub>		-40 ~ +125	°C	
絶縁耐圧 Isolation Voltage	Viso	端子-ベース間, AC 1分間 Terminal to Base, AC 1min.	2500	V	
締付トルク Mounting Torque	ベース部 Mounting	F サマルコバウド塗布 Greased	M5	2.4 ~ 2.8	N・m
	主端子部 Terminal		M5	2.4 ~ 2.8	N・m

### ■電気的特性 Electrical Characteristics

項目 Parameter	記号 Symbol	条件 Conditions	特性値 (最大) Maximum Value	単位 Unit
ピーク逆電流 Peak Reverse Current	*1 I <sub>RM</sub>	T <sub>j</sub> =150°C, V <sub>RM</sub> =V <sub>RRM</sub>	7	mA
ピーク順電圧 Peak Forward Voltage	*1 V <sub>FM</sub>	T <sub>j</sub> =25°C, I <sub>FM</sub> =100A	1.23	V
熱抵抗 Thermal Resistance	R <sub>th(j-c)</sub>	接合部-ケース間 (トルク: T <sub>c</sub> 測定点チップ直下) Junction to Case, Total	0.07	°CW
接触熱抵抗 Thermal Resistance	R <sub>th(c-f)</sub>	ケース-フィン間 (トルク), サマルコバウド塗布 Case to Fin, Total, Greased	0.06	°CW

質量 --- 約 210g  
Approximate Weight

\*1: 1アーム当りの値 Value Per 1 Arm.

順電圧特性  
FORWARD CURRENT VS. VOLTAGE

PT100KN16 (Per 1 Arm.)

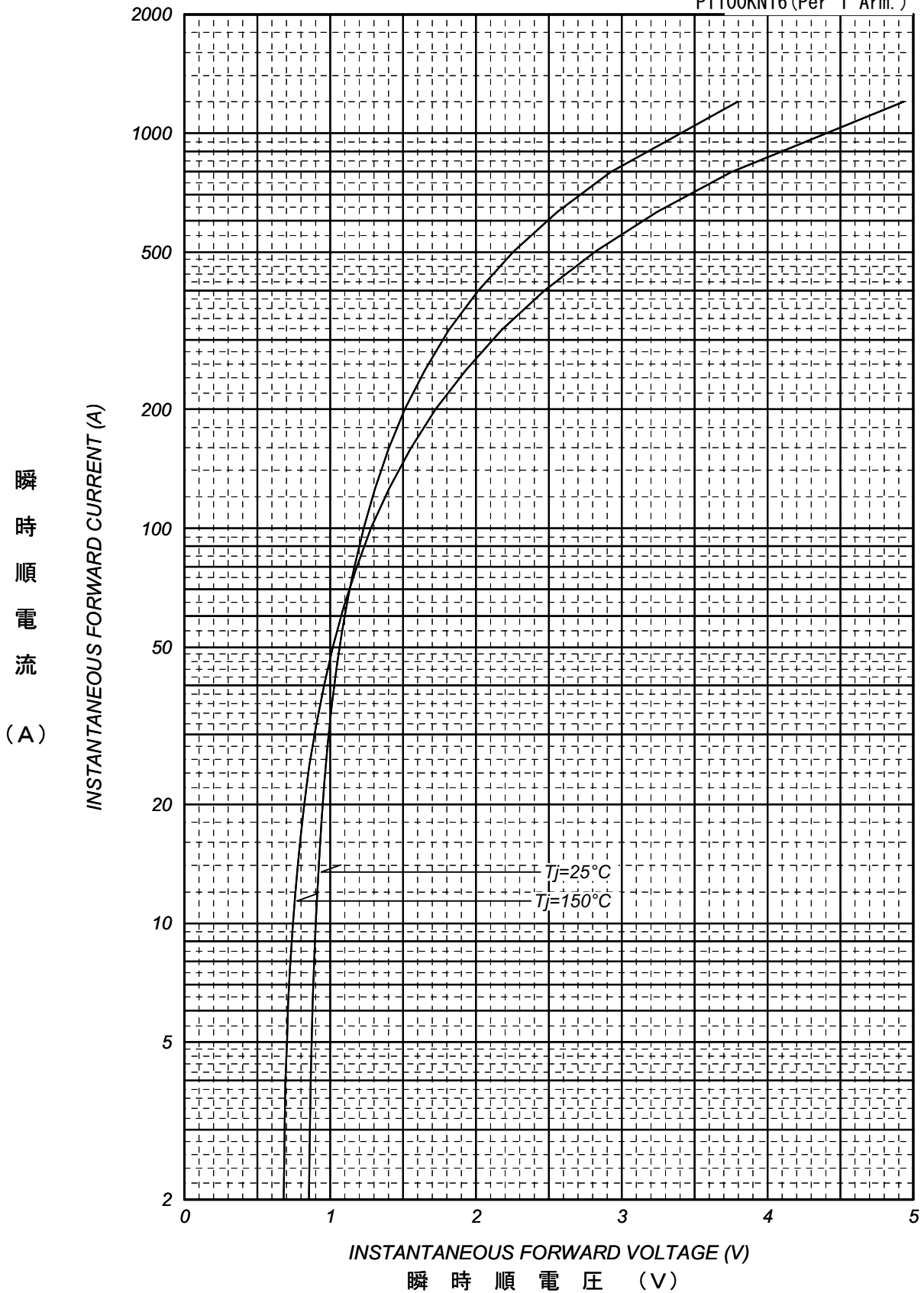

平均順電力損失特性  
AVERAGE FORWARD POWER DISSIPATION

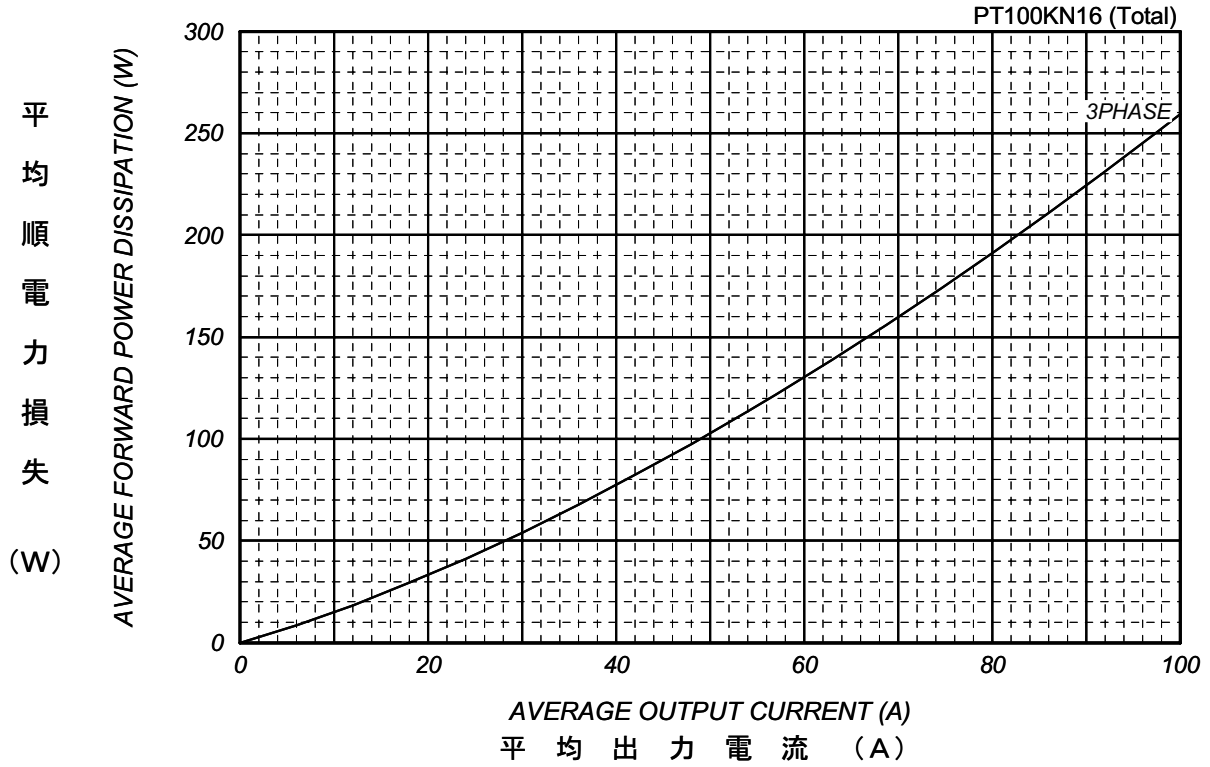

平均出力電流 - ケース温度定格  
AVERAGE OUTPUT CURRENT VS. CASE TEMPERATURE

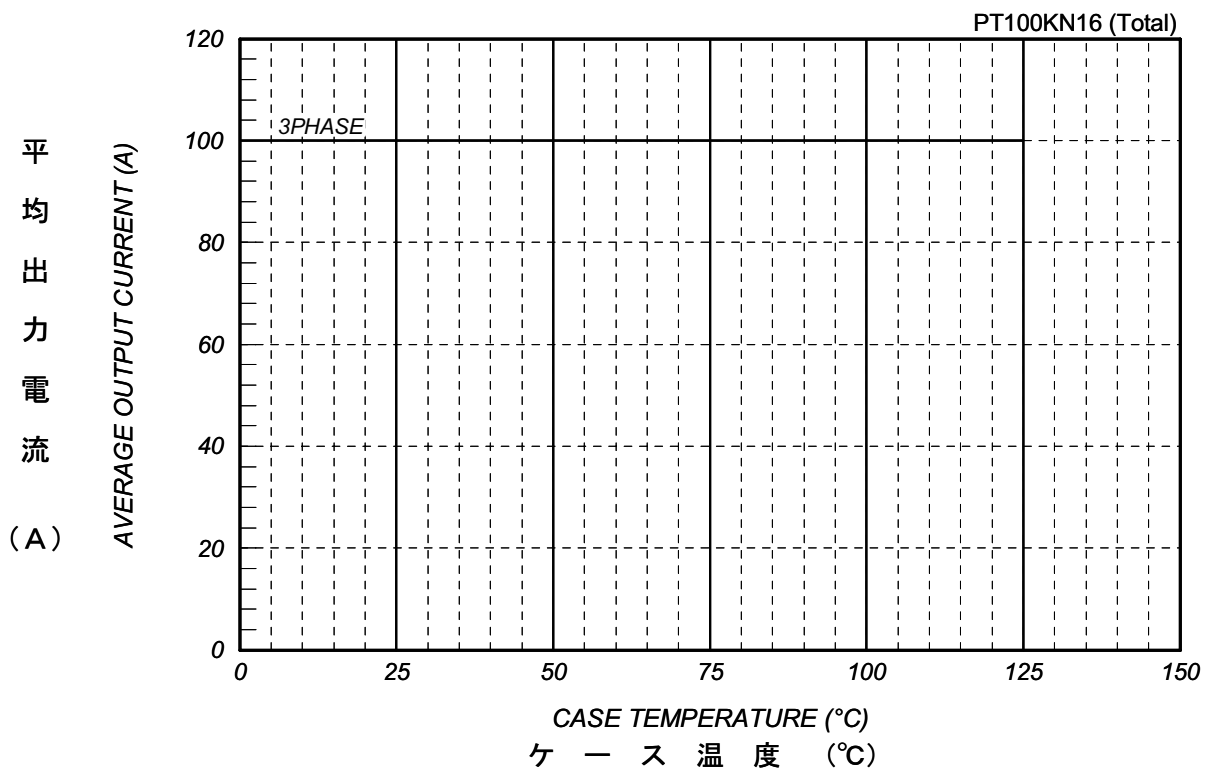

サージ順電流定格  
SURGE CURRENT RATINGS

f=50Hz, Half Sine Wave, Non-Repetitive, Tj=150°C

PT100KN16 (Per 1 Arm.)

サ  
ー  
ジ  
順  
電  
流  
(A)

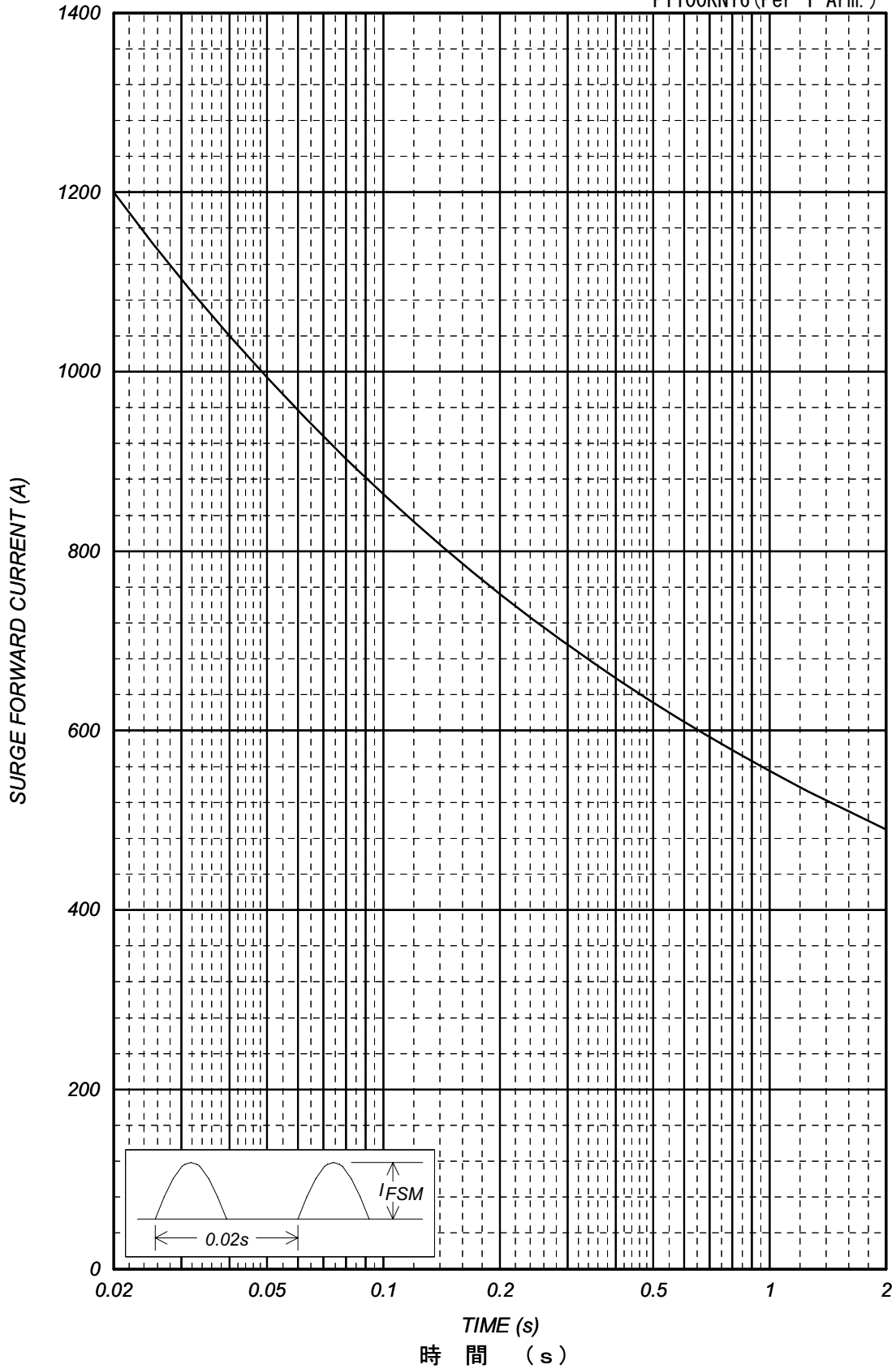

過渡熱抵抗特性  
Transient Thermal Impedance

