

USB-1608G Series

16-Bit High-Speed Multifunction DAQ Devices



USB-1608G Series provides eight differential or 16 single-ended analog inputs, two analog outputs (USB-1608GX-2AO), 8 digital I/O, and one counter input.

Features

- 16-bit high-speed USB devices
- Acquisition rates up to 500 kS/s
- 8 differential (DIFF) or 16 single-ended (SE) analog inputs
- Up to 2 analog outputs
- 8 digital I/O
- Two 32-bit counter inputs
- One timer output
- OEM version available

Supported Operating Systems

- Windows® 11/10/8/7/
Vista®XP 32/64-bit
- Linux®
- Android™

Overview

USB-1608G Series devices are low-cost, high-speed, analog and digital I/O USB devices. All of these devices offer up to eight DIFF or 16 SE analog inputs, eight digital I/O channels, two counter inputs, and one timer output.

The USB-1608GX-2AO standard and OEM version offers two, 16-bit analog output channels with DAC rates up to 500 kS/s.

Analog Input

USB-1608G Series devices provide 16-bit analog inputs that are software-selectable as eight DIFF or 16 SE inputs. These devices also support input ranges of ± 10 V, ± 5 V, ± 2 V, and ± 1 V that are software-selectable per channel.

Analog Output (USB-1608GX-2AO only)

The USB-1608GX-2AO standard/OEM board has two 16-bit analog outputs that can be updated at a rate of 250 kS/s per channel; one output can be updated at a rate of 500 kS/s. The output range is fixed at ± 10 V.

Trigger Input

USB-1608G Series devices have an external digital trigger input. The trigger mode is software-selectable for edge- or level-sensitive mode. You can configure edge-sensitive mode for either rising or falling edge. In level-sensitive mode, you can configure for either high or low level. The default setting at power up is edge-sensitive, rising edge.

Retrigger Mode

Users can set up repetitive analog input trigger events. The trigger is automatically re-armed after it is activated. The A/D trigger count (the number of samples you want per trigger) is configurable with software.

Digital I/O

Eight bidirectional digital I/O lines are individually configurable for input or output. The DIO terminals can detect the state of any TTL-level input. Users can configure for pull-up (+5 V) or pull-down (0 V) with an onboard jumper.

Counter Input

Two 32-bit event counters are provided to count TTL pulses. The counters accept inputs of up to 20 MHz.

Timer Output

The PWM timer output generates a pulse output with a programmable frequency in the range of 0.0149 Hz to 32 MHz. The timer output parameters are software-selectable.

USB-1608G Series Selection Chart

Model	Analog Inputs	Sample Rate (max)	Analog Outputs	Signal I/O	USB Cable and SW CD
USB-1608G	16 SE/8 DIFF	250 kS/s	0	Screw Terminal	✓
USB-1608GX	16 SE/8 DIFF	500 kS/s	0	Screw Terminal	✓
USB-1608GX-2AO	16 SE/8 DIFF	500 kS/s	2	Screw Terminal	✓
USB-1608G-OEM	16 SE/8 DIFF	250 kS/s	0	Header	–
USB-1608GX-OEM	16 SE/8 DIFF	500 kS/s	0	Header	–
USB-1608GX-2AO-OEM	16 SE/8 DIFF	500 kS/s	2	Header	–

USB-1608G Series

Overview



USB-1608G Series Block Diagram

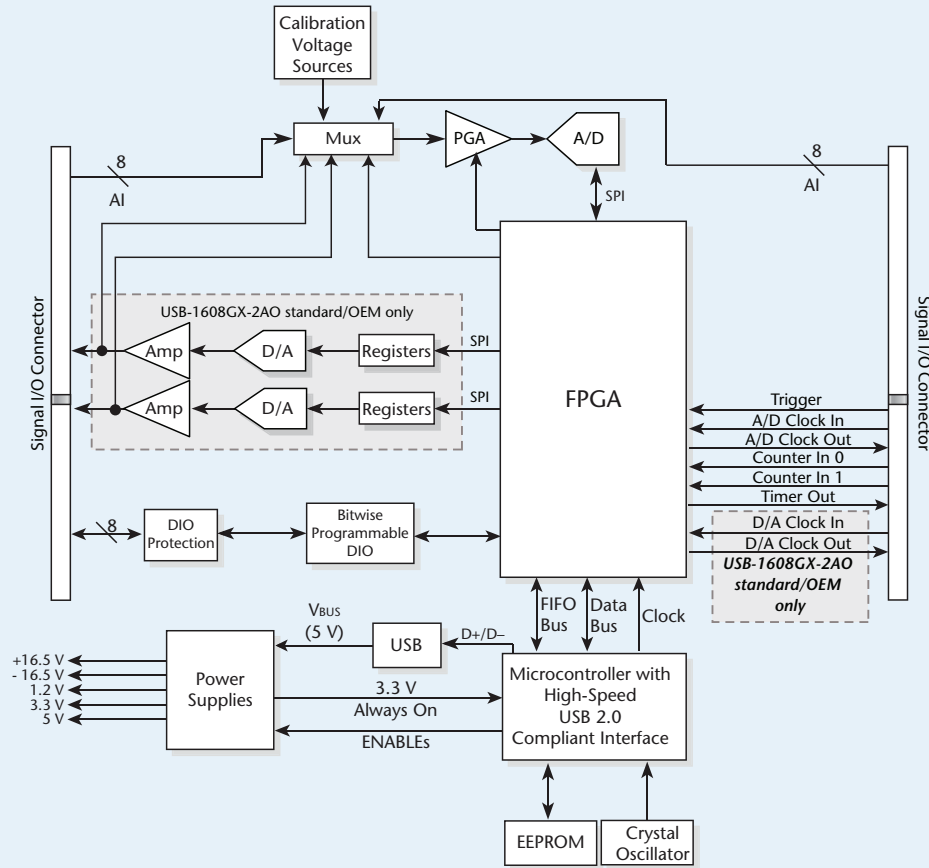

Clock Output

The AI clock pin outputs the signal from the internal clock.

Calibration

The USB-1608G Series is factory-calibrated using a NIST-traceable calibration process. Specifications are guaranteed for one year.

The USB-1608G Series also supports field calibration for users to calibrate the device locally with the InstaCal utility.

USB-1608G Series OEM Versions

OEM versions have board-only form factors with header connectors for OEM and embedded applications (no case, CD, or USB cable included). All devices can be further customized to meet customer needs.

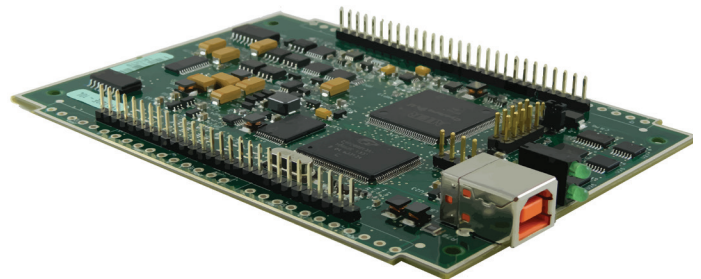

The OEM versions have the same specifications as the standard devices, but come in a board-only form factor with header connectors instead of screw terminals.





USB-1608G Series

Software

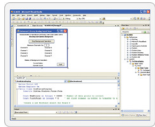

Software Support

USB-1608G Series devices are supported by the software in the table below.

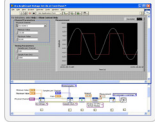
Ready-to-Run Applications	
DAQami™	 <p>Data acquisition companion software with drag-and-drop interface that is used to acquire, view, and log data, and generate signals. DAQami can be configured to log analog, digital, and counter channels, and to view that data in real-time or post-acquisition on user-configurable displays. Logged data can be exported for use in Excel® or MATLAB®. Windows OS</p> <p>DAQami is included with the free MCC DAQ Software bundle. Install DAQami and try the fully-functional software for 30 days. After 30 days, all features except for data logging and data export will continue to be available – data logging and data export features can be unlocked by purchasing the software.</p>
InstaCal™	 <p>An interactive installation, configuration, and test utility for MCC hardware. Windows OS</p> <p>InstaCal is included with the free MCC DAQ Software bundle.</p>
TracerDAQ™ and TracerDAQ Pro	 <p>Virtual strip chart, oscilloscope, function generator, and rate generator applications used to generate, acquire, analyze, display, and export data. Supported features may vary by hardware. The Pro version provides enhanced features. Windows OS</p> <p>TracerDAQ is included with the free MCC DAQ Software bundle.</p> <p>TracerDAQ Pro is available as a purchased software download.</p>
General-Purpose Programming Support	
Universal Library™ (UL) for Windows	 <p>Library for developing applications in C, C++, VB, C# .Net, VB .Net, and Python on Windows. The UL for Windows is included with the free MCC DAQ Software bundle. The UL Python API for Windows is available on GitHub (https://github.com/mccdaq/mcculw).</p>
UL for Linux®	 <p>Library for developing applications in C, C++, and Python on Linux. UL for Linux is available on GitHub (https://github.com/mccdaq/uldaq). Open-source, third-party Linux drivers are also available for supported MCC devices.</p>
UL for Android™	 <p>Library of Java classes for programmers who develop apps for Android-based mobile devices. UL for Android communicates with select MCC DAQ devices. Supports Android project development on Windows, Linux, Mac OS X.</p> <p>UL for Android is included with the free MCC DAQ Software bundle.</p>
Application-Specific Programming Support	
ULx for NI LabVIEW™	 <p>A comprehensive library of VIs and example programs for NI LabVIEW that is used to develop custom applications that interact with most MCC devices. Windows OS</p> <p>ULx for NI LabVIEW is included with the free MCC DAQ Software bundle.</p>
DASYLab®	 <p>Icon-based data acquisition, graphics, control, and analysis software that allows users to create complex applications in minimal time without text-based programming. Windows OS</p> <p>DASYLab is available as a purchased software download. An evaluation version is available for 28 days.</p>
MATLAB® driver	 <p>High-level language and interactive environment for numerical computation, visualization, and programming. The Mathworks Data Acquisition Toolbox™ allows users to acquire data from most MCC PCI and USB devices.</p> <p>Visit www.MathWorks.com for more information about the Data Acquisition Toolbox.</p>

USB-1608G Series

Specifications



Specifications

These specifications apply to both standard and OEM versions unless noted.

Analog Input

A/D converter type: Successive approximation
 ADC resolution: 16 bits
 Number of channels: 8 DIFF, 16 SE; software-selectable
 Input voltage range: ± 10 V, ± 5 V, ± 2 V, ± 1 V; software-selectable per channel
Absolute maximum input voltage
 CHx relative to AGND: ± 25 V max (power on); ± 15 V max (power off)
 Input Impedance: 1 G Ω (power on); 820 Ω (power off)
 Input bias current: ± 10 nA
 Input bandwidth, all input ranges, small signal (-3 dB)
 USB-1608G: 750 kHz
 USB-1608GX/1608GX-2AO: 870 kHz
 Input capacitance: 60 pF
Maximum working voltage (signal + common mode)
 ± 10 V range: ± 10.2 V max relative to AGND
 ± 5 V range: ± 10.2 V max relative to AGND
 ± 2 V range: ± 9.5 V max relative to AGND
 ± 1 V range: ± 9.0 V max relative to AGND

Common mode rejection ratio
 $f_{IN} = 60$ Hz, all input ranges: 86 dB
 Crosstalk
 Adjacent differential mode channels, DC to 100 kHz: -75 dB
 Input coupling: DC
 Sampling rate (software-selectable)
 USB-1608G: 0.0149 Hz to 250 kHz
 USB-1608GX/1608GX-2AO: 0.0149 Hz to 500 kHz
 Trigger source: TRIG (refer to "External Trigger" on page 5)
 Sample clock source: Internal A/D clock or external A/D clock (AICKI terminal)
Burst mode: Software-selectable using the internal A/D clock; always enabled when using the external clock (AICKI terminal)
 USB-1608G: 4 μ s
 USB-1608GX/1608GX-2AO: 2 μ s
Throughput
 Software paced: 33 to 4000 S/s typ, system dependent
 Hardware paced
 USB-1608G: 250 kS/s max
 USB-1608GX/1608GX-2AO: 500 kS/s max
 Channel gain queue: Up to 16 elements; software-selectable range for each channel
 Warm-up time: 15 minutes min

Analog Input DC Voltage Measurement						
All Values are (\pm)						
Range	Gain Error (% of Reading)	Offset Error (μ V)	INL Error (% of Range)	Absolute Accuracy at Full Scale (μ V)	Gain Temperature Coefficient (% reading/ $^{\circ}$ C)	Offset Temperature Coefficient (μ V/ $^{\circ}$ C)
± 10 V	0.024	915	0.0076	4075	0.0014	47
± 5 V	0.024	686	0.0076	2266	0.0014	24
± 2 V	0.024	336	0.0076	968	0.0014	10
± 1 V	0.024	245	0.0076	561	0.0014	5

Noise Performance*		
Range	Counts	LSBrms
± 10 V	6	0.91
± 5 V	6	0.91
± 2 V	7	1.06
± 1 V	9	1.36

* For the peak-to-peak noise distribution test, a differential input channel is connected to AGND at the input terminal block, and 32,000 samples are acquired at the maximum rate available at each setting.

Settling Time**			
USB-1608G			
Range	4 μ s settling accuracy (% FSR)	6 μ s settling accuracy (% FSR)	10 μ s settling accuracy (% FSR)
± 10 V	0.0061	0.0031	0.0015
± 5 V	0.0061	0.0031	0.0015
± 2 V	0.0061	0.0031	0.0015
± 1 V	0.0061	0.0031	0.0015
USB-1608GX/1608GX-2AO			
Range	2 μ s settling accuracy (% FSR)	4 μ s settling accuracy (% FSR)	9 μ s settling accuracy (% FSR)
± 10 V	0.1251	0.0031	0.0015
± 5 V	0.0687	0.0031	0.0015
± 2 V	0.0687	0.0031	0.0015
± 1 V	0.0687	0.0031	0.0015

** Settling time is defined as the expected accuracy after one conversion when switching from a channel with a DC input at one extreme of full scale to another channel with a DC input at the other extreme of full scale. Both input channels are configured for the same input range.

Analog Output (USB-1608GX-2AO only)

Number of channels: 2 (leave unused AOUTx output channels disconnected)
 Resolution: 16 bits
 Output range: ± 10 V (calibrated)
Output transient
 Host computer is reset, powered on, suspended, or a reset command is issued to the device
 Duration: 500 μ s
 Amplitude: 2 V pk-pk
 Powered off
 Duration: 10 ms
 Amplitude: 7 V peak
 Differential non-linearity: ± 0.25 LSB typ; ± 1 LSB max
Output current
 AOUTx: ± 3.5 mA max
Output short-circuit protection
 AOUTx connected to AGND: Unlimited duration
Output coupling: DC
Power on and reset state
 DACs cleared to zero-scale: 0 V, ± 50 mV (AOUTx defaults to 0 V when the host is reset, powered on, suspended, or a reset command is issued to the device)
Output noise: 30 μ Vrms
 Trigger source: TRIG (refer to "External Trigger" on page 5)
 Sample clock source: Internal D/A clock or external D/A clock (AOCKI terminal)
Output update rate: 500 kHz/number of channels in the scan
Settling Time
 To rated accuracy, 10 V step: 40 μ s
 Slew rate: 9 V/ μ s
Throughput
 Software paced: 33 S/s to 4000 S/s typ, system-dependent
 Hardware paced: 500 kS/s max, system-dependent

USB-1608G Series

Specifications



Calibrated Absolute Accuracy

Range: ± 10 V
Absolute accuracy (\pm LSB): 16.0

Calibrated Absolute Accuracy Components

Range: ± 10 V
% of reading: ± 0.0183
Offset (\pm mV): 1.831
Offset Tempco (μ V/ $^{\circ}$ C): 12.7
Gain Tempco (ppm of range/ $^{\circ}$ C): 13

Analog Output Relative Accuracy

Range: ± 10 V
Relative accuracy (INL): 4.0 typ

Analog Input/Output Calibration

Recommended Warm-up Time: 15 minutes min
Calibration method: Self-calibration (firmware)
Calibration interval: 1 year (factory calibration)
AI calibration reference

+5 V, ± 2.5 mV max (actual measured values stored in EEPROM)
Tempco: 5 ppm/ $^{\circ}$ C max
Long term stability: 15 ppm/1000 hours

AOUTx calibration procedure (USB-1608GX-2AO only)

The AOUTx terminals are internally routed to the AI circuit. For best results, disconnect AOUTx connections at the terminal block before calibrating.

Digital I/O

Digital type: CMOS
Number of I/O: 8
Configuration: Bit-configurable as input (power on default) or output
Pull-up configuration: 47 k Ω resistors configurable as pull-up/down (default) via internal jumper (W1).
Digital I/O transfer rate (system-paced): 33 to 8000 port reads/writes or single bit reads/writes per second typ, system dependent.
Input high voltage: 2.0 V min, 5.5 V absolute max
Input low voltage: 0.8 V max, -0.5 V absolute min, 0 V recommended min
Output high voltage: 4.4 V min (IOH = -50 μ A), 3.76 V min (IOH = -2.5 mA)
Output low voltage: 0.1 V max (IOL = 50 μ A), 0.44 V max (IOL = 2.5 mA)
Output current: ± 2.5 mA max

External Trigger

Trigger source: TRIG input
Trigger mode: Software configurable for edge or level sensitive, rising or falling edge, high or low level. Power on default is edge sensitive, rising edge.
Trigger latency: 1 μ s + 1 clock cycle max
Trigger pulse width: 100 ns min
Input type: Schmitt trigger, 33 Ω series resistor and 49.9 k Ω pull-down to ground
Schmitt trigger hysteresis: 0.4 V to 1.2 V
Input high voltage: 2.2 V min, 5.5 V absolute max
Input low voltage: 1.5 V max, -0.5 V absolute min, 0 V recommended min

External Clock I/O

Terminal names
AICKI, AICKO
USB-1608GX-2AO: AICKI, AICKO AOCKI, AOCKO
Terminal types
AxCKI: Input, active on rising edge
AxCKO: Output, power on default is 0 V, active on rising edge
Terminal descriptions
AxCKI: Receives sampling clock from external source
AxCKO: Outputs the internal sampling clock (D/A or A/D clock) or the pulse generated from AxCKI when in external clock mode.
Input clock rate
USB-1608G: 250 kHz max
USB-1608GX/1608GX-2AO: 500 kHz max
Clock pulse width
AxCKI: 400 ns min
AxCKO: 400 ns min

Input type: Schmitt trigger, 33 Ω series resistor, 47 k Ω pull-down to ground
Schmitt trigger hysteresis: 0.4 V to 1.2 V
Input high voltage: 2.2 V min, 5.5 V absolute max
Input low voltage: 1.5 V max, -0.5 V absolute min, 0 V recommended min
Output high voltage: 4.4 V min (IOH = -50 μ A), 3.76 V min (IOH = -2.5 mA)
Output low voltage: 0.1 V max (IOL = 50 μ A), 0.44 V max (IOL = 2.5 mA)
Output current: ± 2.5 mA max

Counter Input

Terminal names: CTR0, CTR1
Number of channels: 2 channels
Resolution: 32-bit
Counter type: Event counter
Input type: Schmitt trigger, 33 Ω series resistor, 47 k Ω pull-down to ground
Input source:
CTR0 (terminal 52)
CTR1 (terminal 51)
Counter read/Writes rates (Software-paced) : 33 to 8000 reads/writes per second typ, system dependent
Input high voltage: 2.2 V min, 5.5 V max
Input low voltage: 1.5 V max, -0.5 V min
Schmitt trigger hysteresis: 0.4 V min, 1.2 V max
Input frequency: 20 MHz, max
High pulse width: 25 ns, min
Low pulse width: 25 ns, min

Timer Output

Timer terminal name: TMR
Timer type: PWM output with count, period, delay, and pulse width registers
Output value: Idle low with pulses high, software-selectable output invert
Internal clock frequency: 64 MHz
Register widths: 32-bit
High pulse width: 15.625 ns min
Low pulse width: 15.625 ns min
Output high voltage: 4.4 V min (IOH = -50 μ A), 3.76 V min (IOH = -2.5 mA)
Output low voltage: 0.1 V max (IOL = 50 μ A), 0.44 V max (IOL = 2.5 mA)
Output Current: ± 2.5 mA max

Memory

Data FIFO:
USB-1608G/1608GX: 4 kS analog input
USB-1608GX-2AO: 4 kS analog input, 2 kS analog output
Non-volatile memory: 32 KB (28 KB firmware storage, 4 KB calibration/user data)

Power

Supply current
The total quiescent current requirement includes up to 10 mA for the Status LED; this does not include any potential loading of the digital I/O bits, +5 V terminal, or the AOUTx outputs (USB-1608GX-2AO only).
Quiescent Current
USB-1608G/1608GX: 230 mA
USB-1608GX-2AO: 260 mA
+5 V user output voltage range (available at Terminal 43): 4.5 V min to 5.25 V max
+5 V user output current (available at terminal 43): 10 mA max

Environmental

Operating temperature range: 0 $^{\circ}$ C to 55 $^{\circ}$ C max
Storage temperature range: -40 $^{\circ}$ C to 85 $^{\circ}$ C max
Humidity: 0% to 90% non-condensing max

Mechanical

Signal I/O connector
-OEM models: Two 28-pin, 0.1 in. pitch headers
All other devices: 2 banks of screw-terminal blocks (wire gauge range 16 AWG to 30 AWG)
Dimensions (L \times W \times H):
Standard version: 127 \times 89.9 \times 35.6 mm (5.00 \times 3.53 \times 1.40 in.)
OEM version: 121.92 \times 86.36 \times 15.24 (4.80 \times 3.40 \times 0.60 in.)

USB-1608G Series

Ordering



Order Information

Hardware

Part No.	Description
USB-1608G	16-channel, 250 kS/s sampling DAQ device with two 32-bit counter inputs, one timer output, and eight digital I/O lines. Includes a USB cable and MCC DAQ software.
USB-1608GX	16-channel, 500 kS/s sampling DAQ device with two 32-bit counter inputs, one timer output, and eight digital I/O lines. Includes a USB cable and MCC DAQ software.
USB-1608GX-2AO	16-channel, 500 kS/s sampling DAQ device with two analog outputs, two 32-bit counter inputs, one timer output, and eight digital I/O lines. Includes a USB cable and MCC DAQ software.
USB-1608G-OEM	Board-only DAQ device with 16-channels, 250 kS/s sampling, two 32-bit counter inputs, one timer output, and eight digital I/O lines.
USB-1608GX-OEM	Board-only DAQ device with 16-channels, 500 kS/s sampling, two 32-bit counter inputs, one timer output, and eight digital I/O lines.
USB-1608GX-2AO-OEM	Board-only DAQ device with 16-channels, 500 kS/s sampling, two analog outputs, two 32-bit counter inputs, one timer output, and eight digital I/O lines.

Software also Available from MCC

DAQami	Easy-to-use advanced data logging software to acquire, view, and log data
TracerDAQ Pro	Out-of-the-box virtual instrument suite with strip chart, oscilloscope, function generator, and rate generator – professional version
DASYLab	Icon-based data acquisition, graphics, control, and analysis software