

THIS DOCUMENT IS SUBJECT TO CHANGE WITHOUT NOTICE. IT IS CONFIDENTIAL AND A PROPERTY OF Amphenol LTW. DISCLOSURE TO THIRD PARTY HAS TO BE AUTHORIZED BY Amphenol LTW.

REV.	ECN NO.	DATE	SIGN	DESCRIPTION
E	C201472	2020/09/29	Vicky	△E X4
F	C210023	2021/01/14	Vicky	△E X2
G	C210309	2021/02/24	Ruru	△G X3

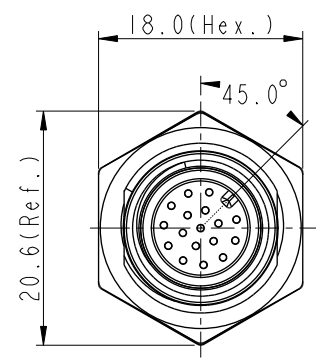
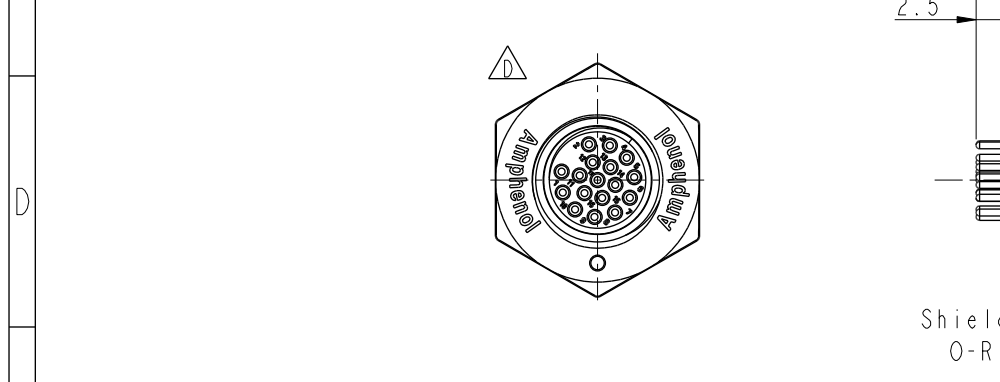
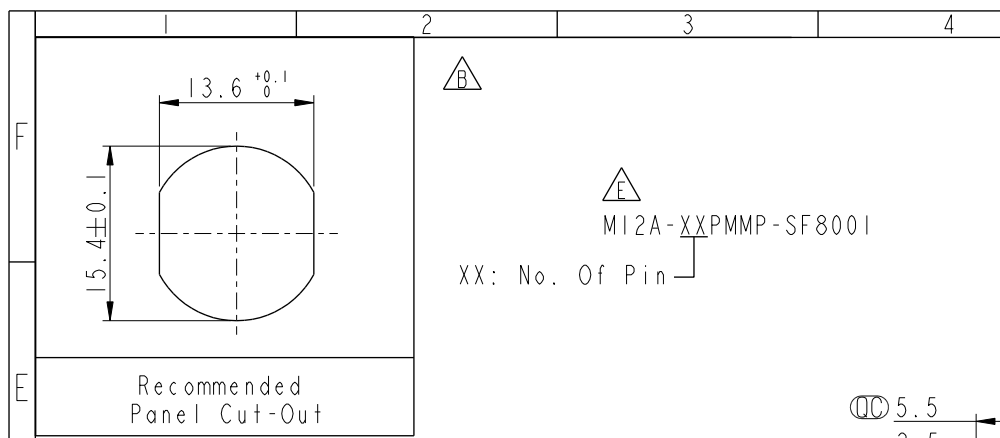

- △E △G Note:**
- * RoHS Compliant
 - * \varnothing Important dimension
 - * △C Waterproof rate: IPX8, unmated 1m/24h
IPX9K, unmated
 - * Connector
 - Housing: Thermoplastic, Black
 - Pin: Copper alloy, Gold plated
 - * △E △F Shield: Metal
 - * △E △F Nut: Metal
 - * O-Ring: Rubber, Black
 - * For panel thickness max: 4.5mm
 - * Nut is packed separately in pe bag

UNIT: mm	TOLERANCE	SCALE	SIZE	SHEET	OF
	.X ±0.25	2:1	A4	1	2
	.XX ±0.1				
	.XXX ±0.05				
	ANGLES ±1°				

UNIT: mm		TITLE N SEN, M12 A, SCREW RECEPTACLE, M, M, PCB S △G	
TOLERANCE		SCALE	SHEET OF
.X ±0.25		2:1	1 2
.XX ±0.1			
.XXX ±0.05			
ANGLES ±1°			

Amphenol LTW
安費諾亮泰企業股份有限公司

ITEM NO.	DRAWN BY	DATE
	Yulong_wang	2016-08-08
DWG NO.	CHECKED BY	DATE
△E M12A-XXPMMP-SF8001	Jinhai	2016-08-08
CUSTOMER	APPROVED BY	DATE
ALTW	Jerry	2016-08-08

THIS DOCUMENT IS SUBJECT TO CHANGE WITHOUT NOTICE. IT IS CONFIDENTIAL AND A PROPERTY OF Amphenol LTW. DISCLOSURE TO THIRD PARTY HAS TO BE AUTHORIZED BY Amphenol LTW.

1 2 3 4 5 6 7 8

F
E
D
C
B
A

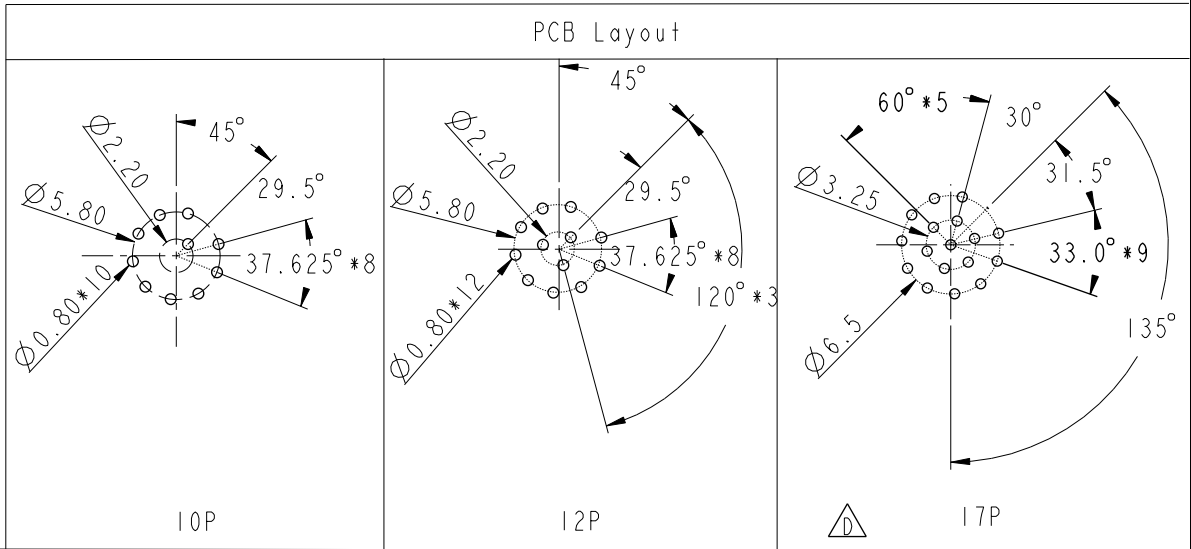
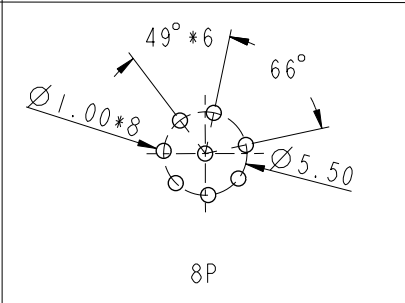
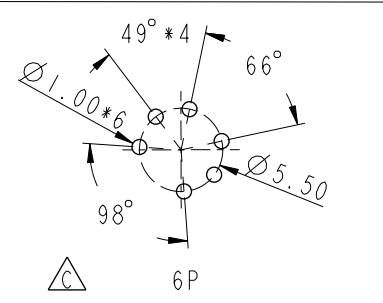
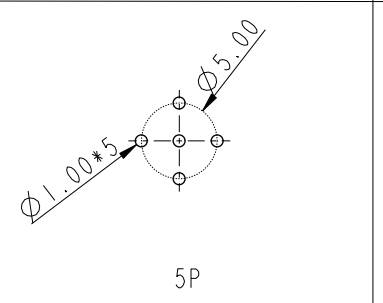
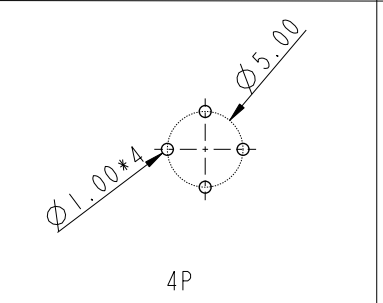
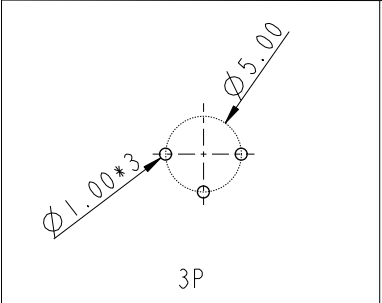

UNIT: mm

TOLERANCE	±0.25
.X	±0.1
.XX	±0.05
.XXX	±0.05
ANGLES	±1°

TITLE N SEN, M12 A, SCREW RECEPTACLE, M, M, PCB S			
SCALE	SIZE	SHEET	OF
2:1	A4	2	2
REV.	WC-REV.	QC: Inspection item	
G	A.4		

Amphenol LTW
安費諾亮泰企業股份有限公司

ITEM NO	DWG NO
	M12A-XXPMMP-SF8001
CUSTOMER	
ALTW	

DRAWN BY	CHECKED BY
Yulong_wang	Jinhai
APPROVED BY	
Jerry	

DATE	DATE
2016-08-08	2016-08-08
DATE	DATE
2016-08-08	2016-08-08

2 3 4 5 6 7 8 W10814-03-01A2