



MPQ4468

36V, 3.5A, Low-Quiescent Current,
Asynchronous Step-Down Converter,
AEC-Q100 Qualified

DESCRIPTION

The MPQ4468 is a frequency-programmable (350kHz to 2.5MHz), asynchronous, step-down switching regulator with an integrated internal high-side power MOSFET. It provides up to 3.5A of highly efficient output current with current mode control for fast loop response.

The wide 3.3V to 36V input range accommodates a variety of step-down applications in automotive input environments, and is ideal for battery-powered applications due to its extremely low quiescent current.

The MPQ4468 employs AAM (advanced asynchronous modulation) mode, which helps achieve high efficiency in light-load condition by scaling down the switching frequency to reduce switching and gate driving losses.

Standard features include soft start (SS), external clock sync, enable (EN) control, and a power good (PG) indicator. High duty cycle and low dropout mode are provided for automotive cold-crank condition.

Over-current protection (OCP) is employed to prevent the inductor current from running away. Hiccup mode greatly reduces the average current in short-circuit condition. Thermal shutdown provides reliable, fault-tolerant operation. The MPQ4468 is available in a QFN-16 (3mmx4mm) package.

FEATURES

- Wide 3.3V-to-36V Operating Input Range
- 3.5A Continuous Output Current
- 1 μ A Low Shutdown Mode Current
- 10 μ A Sleep Mode Quiescent Current
- Internal 90m Ω High-Side MOSFET
- 350kHz to 2.5MHz Programmable Switching Frequency
- Synchronize to External Clock
- Selectable In-Phase or 180° Out-of-Phase
- Power Good Indicator
- Programmable Soft-Start Time
- 80ns Minimum On Time
- Low Dropout Mode
- Over-Current Protection and Hiccup Mode
- Available in a QFN-16 (3mmx4mm) Package
- AEC-Q100 Grade 1

APPLICATIONS

- Automotive Systems
- Industrial Power Systems

All MPS parts are lead-free, halogen-free, and adhere to the RoHS directive. For MPS green status, please visit the MPS website under Quality Assurance. "MPS", the MPS logo, and "Simple, Easy Solutions" are registered trademarks of Monolithic Power Systems, Inc. or its subsidiaries.

TYPICAL APPLICATION

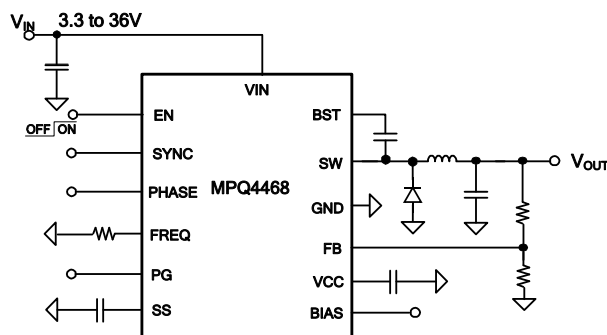

Efficiency vs. Load Current

$V_{OUT} = 5V$, $f_{sw} = 500kHz$

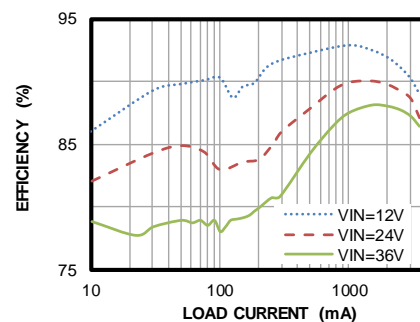

ORDERING INFORMATION

Part Number*	Package	Top Marking	MSL Rating**
MPQ4468GL-AEC1	QFN-16 (3mmx4mm)	See Below	1

* For Tape & Reel, add suffix -Z (e.g. MPQ4468GL-AEC1-Z).

** Moisture Sensitivity Level Rating

TOP MARKING

MPYW

4468

LLL

MP: MPS prefix

Y: Year code

W: Week code

4468: First four digits of the part number

LLL: Lot number

PACKAGE REFERENCE

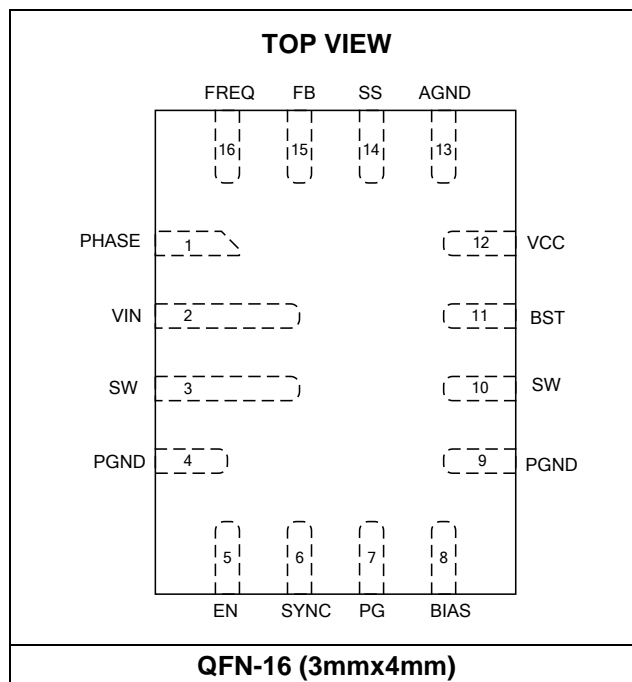

PIN FUNCTIONS

Pin #	Name	Description
1	PHASE	Selectable in-phase or 180° out-of-phase of SYNC input. Drive high to be in-phase, or drive low to be 180° out-of-phase. If the SYNC function is not used, do not float the pin to avoid any uncertain status. Connecting to GND is recommended.
2	VIN	Input supply. VIN supplies power to all of the internal control circuitries and the power switch connected to SW. A decoupling capacitor to ground must be placed close to VIN to minimize switching spikes.
3, 10	SW	Switch node. SW is the output of the internal power switch.
4, 9	PGND	Power ground. PGND is the reference ground of the power device, and requires careful consideration during PCB layout. For best results, connect PGND with copper pours and vias.
5	EN	Enable. Pull this pin below the specified threshold to shut the chip down. Pull it above the specified threshold to enable the chip.
6	SYNC	Synchronize. Apply a 350kHz to 2.5MHz clock signal to this pin to synchronize the internal oscillator frequency to the external clock. The external clock should be at least 250kHz larger than the R _{FREQ} set frequency. Connect to GND if not used.
7	PG	Power good indicator. The output of this pin is an open drain, and goes high if the output voltage is within ±10% of the nominal voltage.
8	BIAS	External power supply for internal regulator. Connect BIAS to an external power supply ($5V \leq V_{BIAS} \leq 18V$) to reduce power dissipation and increase efficiency. Float this pin or connect to ground if not used.
11	BST	Bootstrap. BST is the positive power supply of the high-side MOSFET driver connected to SW. Connect a bypass capacitor between BST and SW.
12	VCC	Internal bias supply. VCC supplies power to the internal control circuit and gate drivers. A $\geq 1\mu F$ decoupling capacitor to ground is required close to this pin.
13	AGND	Analog ground. Reference ground of the logic circuit.
14	SS	Soft-start input. Place an external capacitor from SS to AGND to set the soft-start period. The MPQ4468 sources 10 μA from SS to the soft-start capacitor at start-up. As the SS voltage rises, the feedback threshold voltage increases to limit inrush current during start-up.
15	FB	Feedback input. Connect FB to the tap of an external resistor divider from the output to AGND to set the output voltage. The feedback threshold voltage is 0.8V. Place the resistor divider as close to FB as possible. Avoid placing vias on the FB traces.
16	FREQ	Switching frequency program. Connect a resistor from this pin to ground to set the switching frequency.

ABSOLUTE MAXIMUM RATINGS ⁽¹⁾

Supply voltage (V _{IN})	-0.3V to 40V
Switch voltage (V _{SW})	-0.3V to V _{IN} + 0.3V
BST voltage (V _{BST})	V _{SW} + 6.5V
EN voltage (V _{EN})	-0.3V to 40V
BIAS voltage (V _{BIAS})	-0.3V to 20V
All other pins	-0.3V to 6V
Continuous power dissipation (T _A = +25°C) ⁽²⁾	
QFN-16 (3mmx4mm)	2.6W
Operating junction temperature.....	150°C
Lead temperature	260°C
Storage temperature.....	-65°C to 150°C

Electrostatic Discharge (ESD) Level

HBM (Human Body Model)	±2000V
CDM (Charged Device Model)	±750V

Recommended Operating Conditions

Supply voltage (V _{IN})	3.3V to 36V
Operating junction temp (T _J)	
.....	-40°C to +125°C ⁽³⁾

Thermal Resistance	θ_{JA}	θ_{JC}
QFN-16 (3mmx4mm)		
JESD51-7 ⁽⁴⁾	48	11 ... °C/W
EVQ4468-L-00A ⁽⁵⁾	41	4 °C/W

Notes:

- 1) Absolute maximum ratings are rated under room temperature unless otherwise noted. Exceeding these ratings may damage the device.
- 2) The maximum allowable power dissipation is a function of the maximum junction temperature T_J (MAX), the junction-to-ambient thermal resistance θ_{JA}, and the ambient temperature T_A. The maximum allowable continuous power dissipation at any ambient temperature is calculated by P_D (MAX) = (T_J (MAX) - T_A) / θ_{JA}. Exceeding the maximum allowable power dissipation will cause excessive die temperature, and the regulator will go into thermal shutdown. Internal thermal shutdown circuitry protects the device from permanent damage.
- 3) Operation devices at junction temperature greater than 125°C is possible; contact MPS for details.
- 4) The value of θ_{JA} given in this table is only valid for comparison with other packages and cannot be used for design purposes. These values were calculated in accordance with JESD51-7, and simulated on a specified JEDEC board. They do not represent the performance obtained in an actual application.
- 5) Measured on EVQ4468-L-00A, 4-layer PCB, 6.35cm×6.35cm.

ELECTRICAL CHARACTERISTICS

V_{IN} = 12V, V_{EN} = 2V, T_J = -40°C to +125°C, typical values are at T_J = +25°C, unless otherwise noted.

Parameter	Symbol	Condition	Min	Typ	Max	Units
V _{IN} quiescent current	I _Q	V _{FB} = 0.85V, no load, no switching, T _J = +25°C		10	18	μA
		V _{FB} = 0.85V, no load, no switching		10	25	
V _{IN} shutdown current	I _{SHDN}	V _{EN} = 0V		1	5	μA
V _{IN} under-voltage lockout threshold rising	INUV _{RISE}		2.3	2.8	3.2	V
V _{IN} under-voltage lockout threshold hysteresis	INUV _{HYS}			150		mV
Feedback reference voltage	V _{REF}		784	800	816	mV
		T _J = 25°C	792	800	808	mV
Switching frequency	f _{SW}	R _{FREQ} = 180kΩ or from sync clock	400	475	550	kHz
		R _{FREQ} = 82kΩ or from sync clock	850	1000	1150	kHz
		R _{FREQ} = 27kΩ or from sync clock	2250	2500	2750	kHz
Minimum on time ⁽⁶⁾	T _{ON_MIN}			80		ns
Sync input low voltage	V _{SYNC_LOW}				0.4	V
Sync input high voltage	V _{SYNC_HIGH}		1.8			V
Current limit	I _{LIMIT_HS}	Duty cycle = 40%	4.7	5.8	7.3	A
Switch leakage current	I _{SW_LKG}			0.01	1	μA
HS switch on resistance	R _{ON_HS}	V _{BST} - V _{SW} = 5V		90	155	mΩ
Soft-start current	I _{SS}	V _{SS} = 0.8V	5	10	15	μA
EN rising threshold	V _{EN_RISING}		0.9	1.05	1.2	V
EN threshold hysteresis	V _{EN_HYS}			120		mV
PG rising threshold (V _{FB} / V _{REF})	PG _{RISE}	V _{FB} rising	85	90	95	%
		V _{FB} falling	105	110	115	
PG falling threshold (V _{FB} / V _{REF})	PG _{FALL}	V _{FB} falling	79	84	89	%
		V _{FB} rising	113.5	118.5	123.5	%
PG deglitch timer	T _{PG_DEGLITCH}	PG from low to high		30		μs
		PG from high to low		50		μs
PG output voltage low	V _{PG_LOW}	I _{SINK} = 2mA		0.2	0.4	V
VCC regulator	V _{CC}			5		V
VCC load regulation		I _{CC} = 5mA			3	%
Thermal shutdown ⁽⁶⁾	T _{SD}			170		°C
Thermal shutdown hysteresis ⁽⁶⁾	T _{SD_HYS}			20		°C

Note:

6) Guaranteed by design and characterization, and not tested in production.

TYPICAL CHARACTERISTICS

V_{IN} = 12V, T_J = -40°C to +125°C, unless otherwise noted.

Quiescent Current vs. Temperature

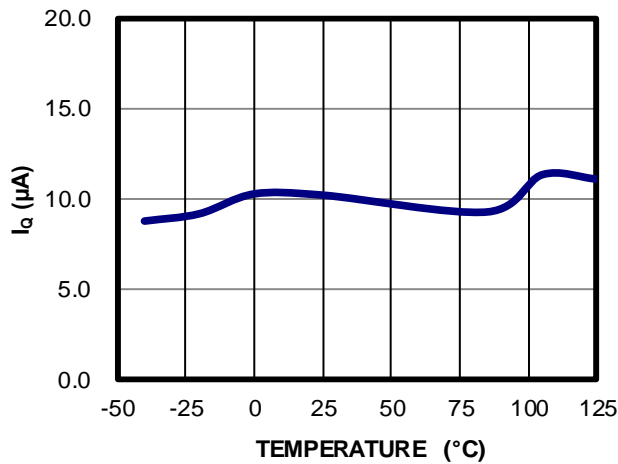

Shutdown Current vs. Temperature

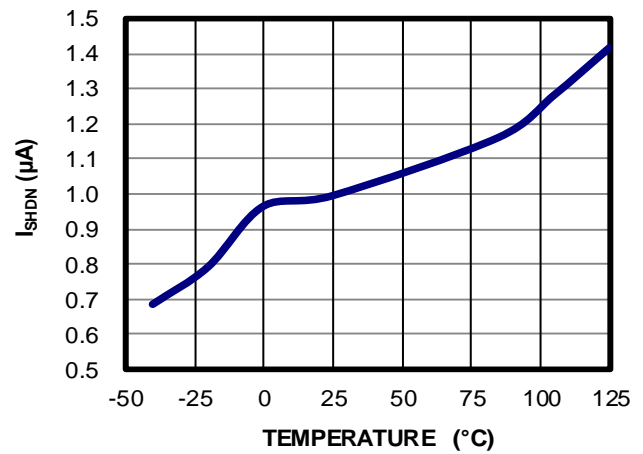

V_{IN} UVLO Threshold vs. Temperature

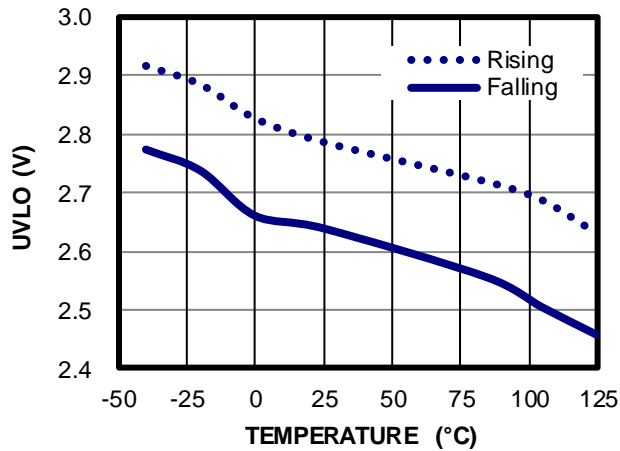

Feedback Reference vs. Temperature

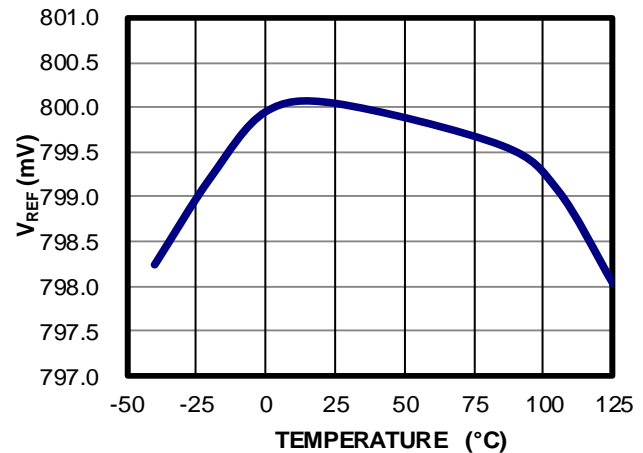

Switching Frequency vs. Temperature

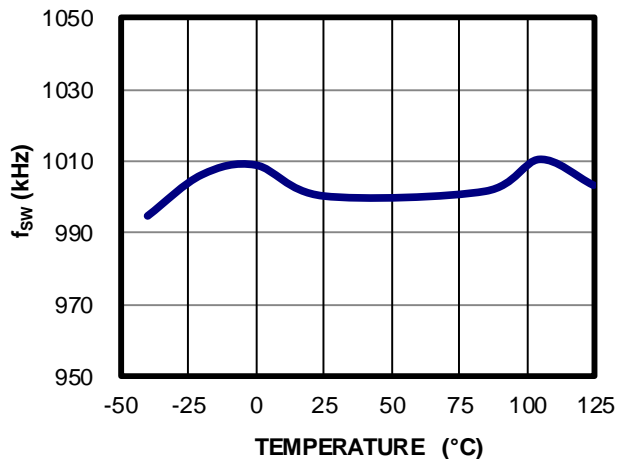

Current Limit vs. Temperature

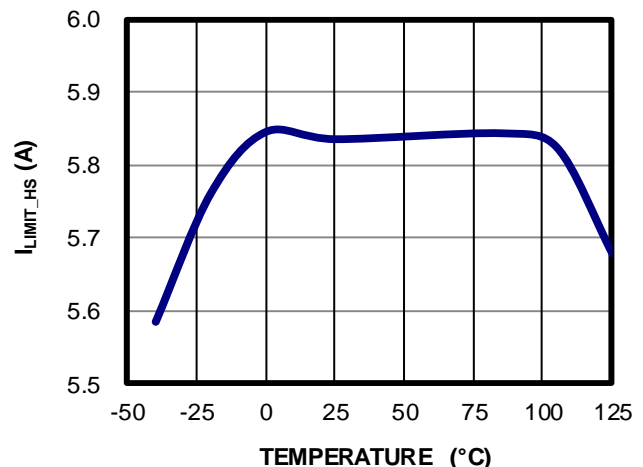

TYPICAL CHARACTERISTICS (continued)
 $V_{IN} = 12V$, $T_J = -40^{\circ}C$ to $+125^{\circ}C$, unless otherwise noted.

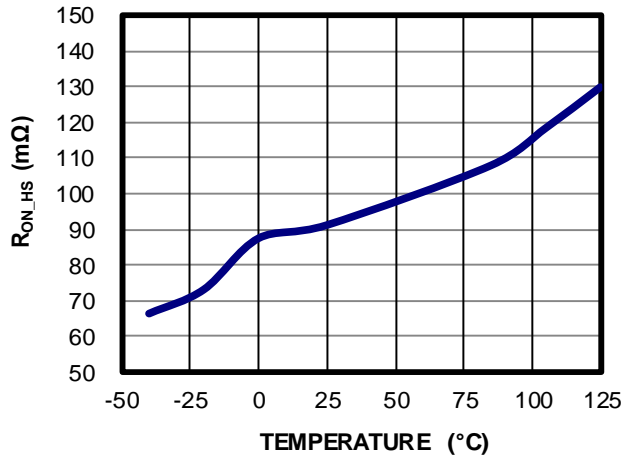
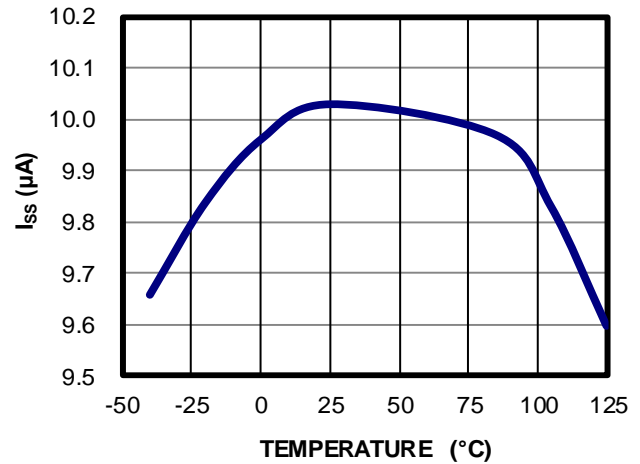
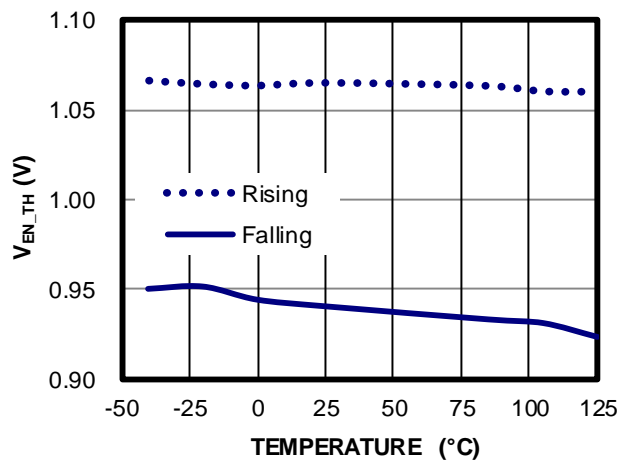
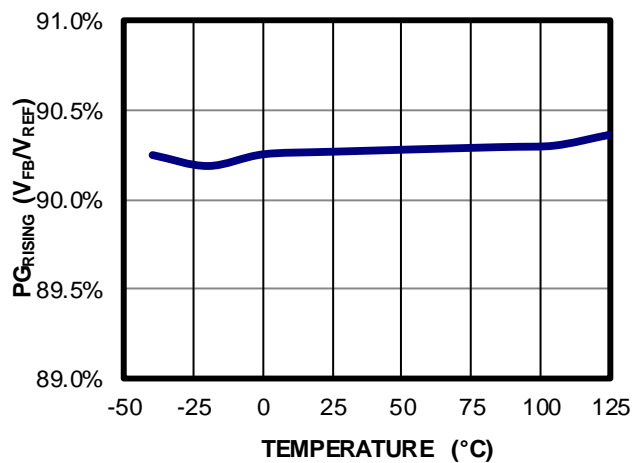
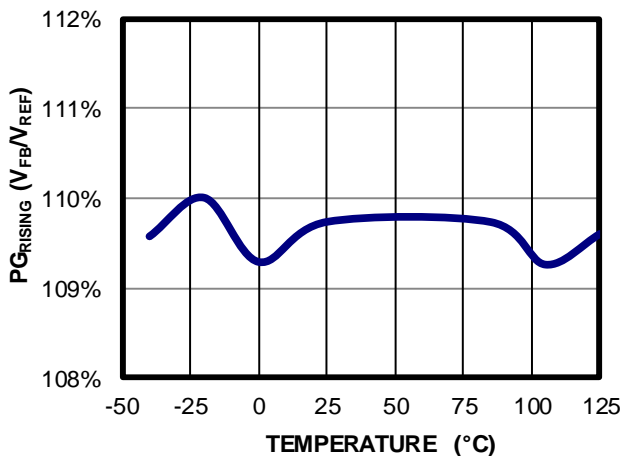
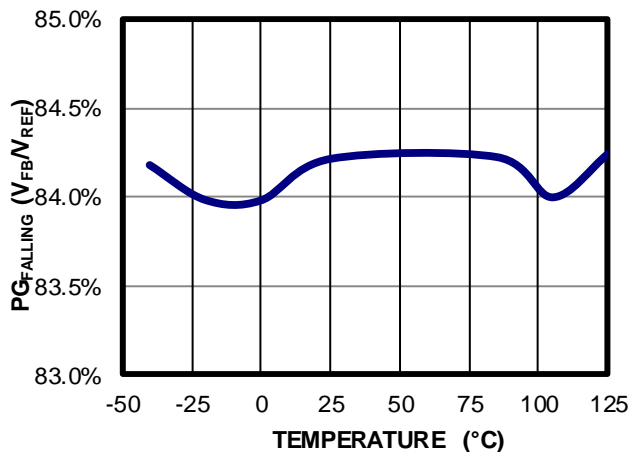
HS-FET On Resistance vs. Temperature

Soft-Start Current vs. Temperature

EN Threshold vs. Temperature

PG Rising Threshold (V_{FB} Rising) vs. Temperature

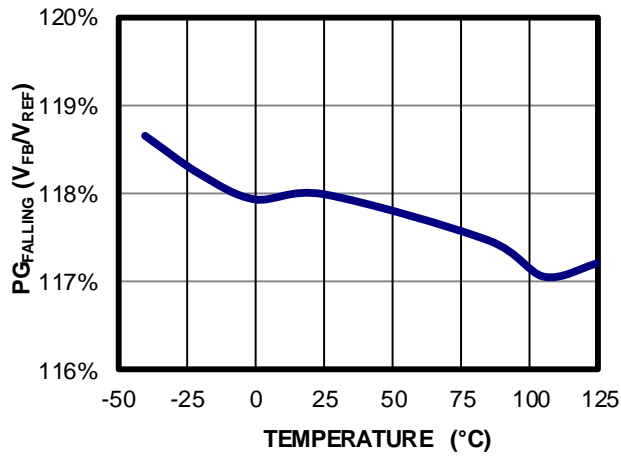
PG Rising Threshold (V_{FB} Falling) vs. Temperature

PG Falling Threshold (V_{FB} Falling) vs. Temperature

TYPICAL CHARACTERISTICS *(continued)*

V_{IN} = 12V, T_J = -40°C to +125°C, unless otherwise noted.

PG Falling Threshold (V_{FB} Rising) vs. Temperature



TYPICAL PERFORMANCE CHARACTERISTICS

V_{IN} = 12V, V_{OUT} = 3.3V, L = 10μH, f_{SW} = 500kHz, T_A = +25°C, unless otherwise noted.

Current Limit vs. Duty Cycle

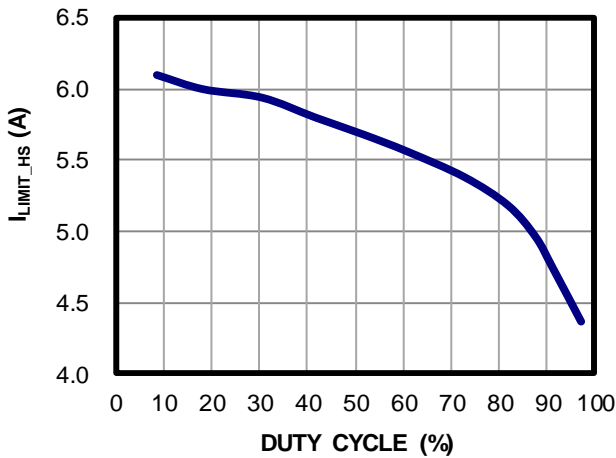

f_{SW} vs. R_{FREQ}

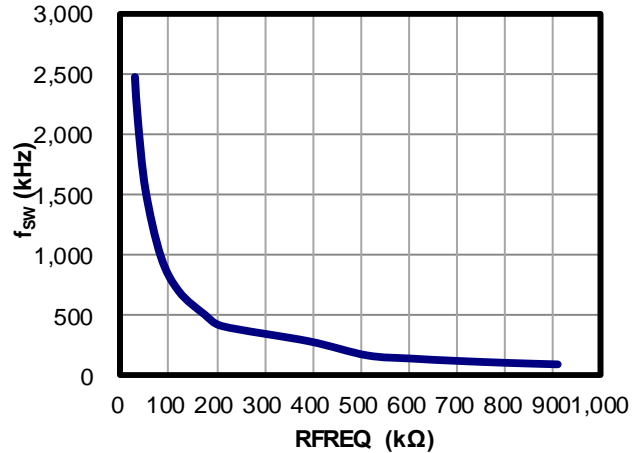

Output Voltage vs. Load Current Dropout Performance

(Set nominal V_{OUT} > V_{IN})

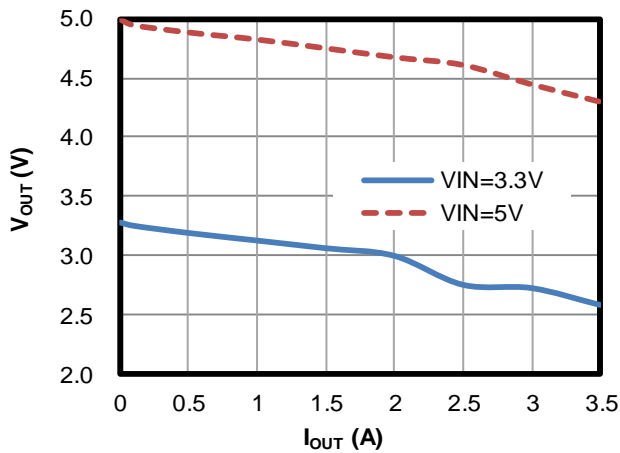

Line Regulation

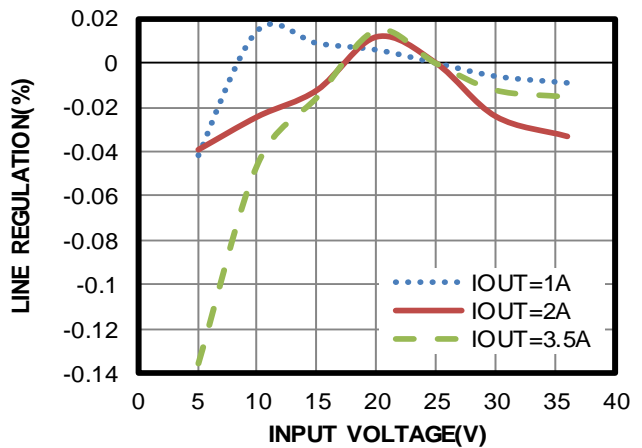

Load Regulation

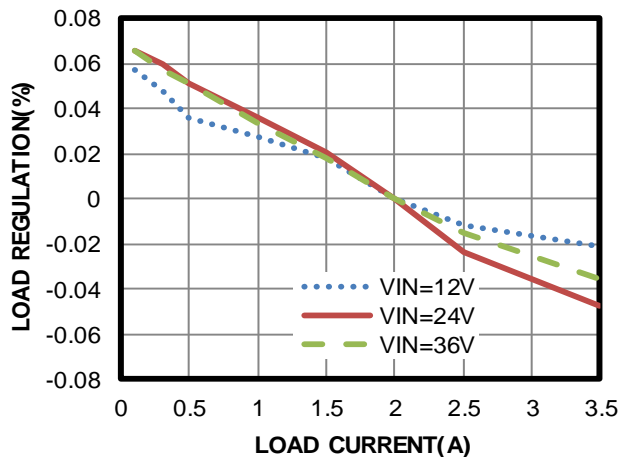

TYPICAL PERFORMANCE CHARACTERISTICS (continued)
 $V_{IN} = 12V$, $V_{OUT} = 3.3V$, $L = 10\mu H$, $f_{SW} = 500kHz$, $T_A = +25^\circ C$, unless otherwise noted.

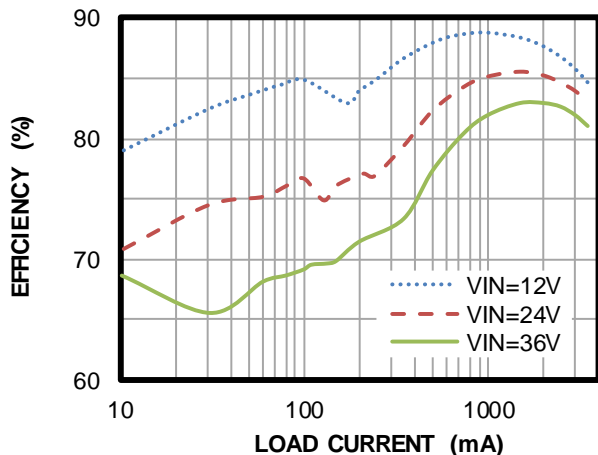
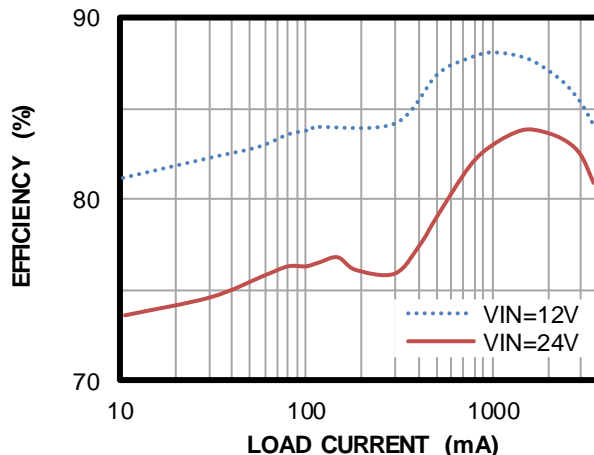
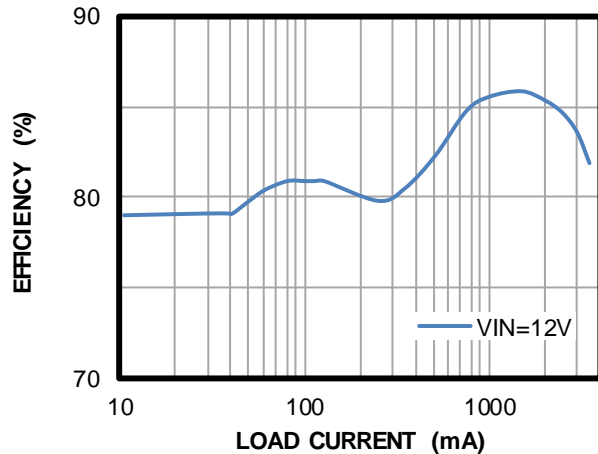
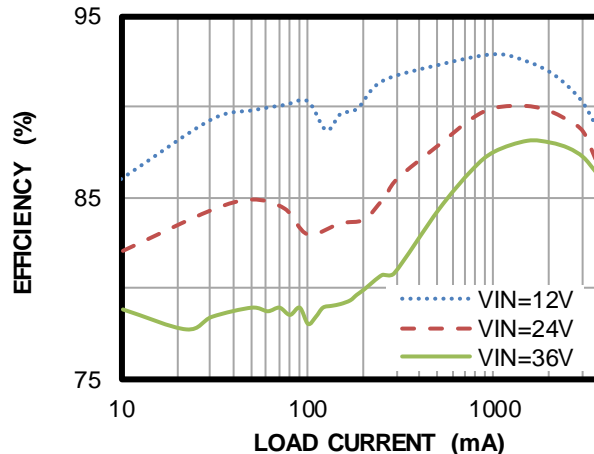
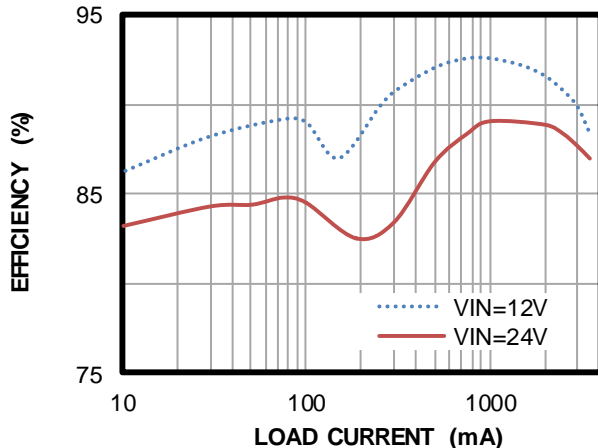
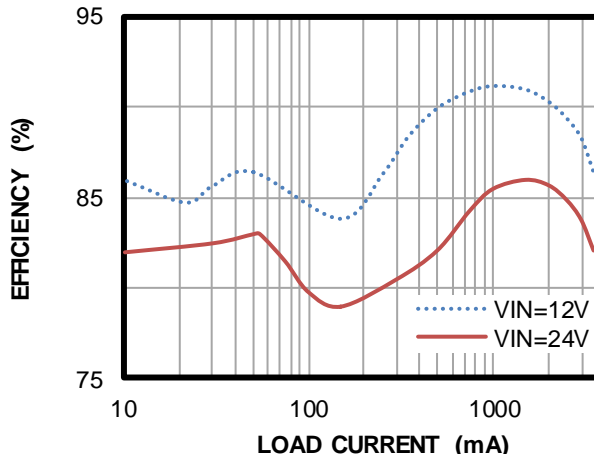
Efficiency vs. Load Current
 $V_{OUT} = 3.3V$, $f_{SW} = 500kHz$

Efficiency vs. Load Current
 $V_{OUT} = 3.3V$, $f_{SW} = 1MHz$

Efficiency vs. Load Current
 $V_{OUT} = 3.3V$, $f_{SW} = 2.2MHz$

Efficiency vs. Load Current
 $V_{OUT} = 5V$, $f_{SW} = 500kHz$

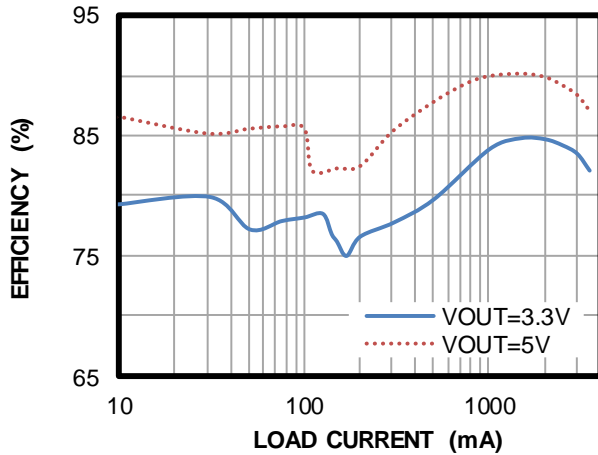
Efficiency vs. Load Current
 $V_{OUT} = 5V$, $f_{SW} = 1MHz$

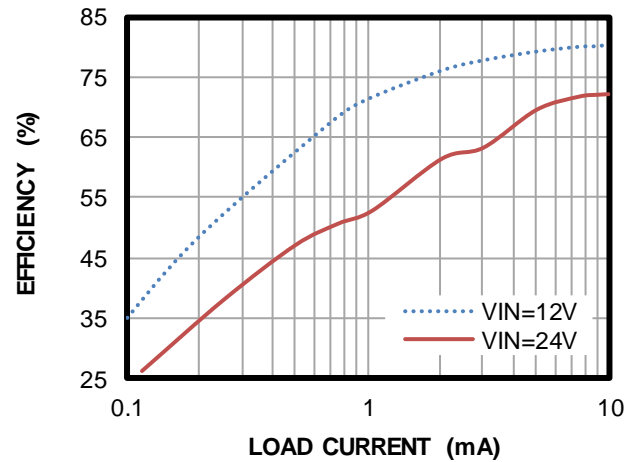
Efficiency vs. Load Current
 $V_{OUT} = 5V$, $f_{SW} = 2.2MHz$

TYPICAL PERFORMANCE CHARACTERISTICS (continued)

 V_{IN} = 12V, V_{OUT} = 3.3V, L = 10μH, f_{sw} = 500kHz, T_A = +25°C, unless otherwise noted.

Efficiency vs. Load Current

 V_{IN} = 14V, f_{sw} = 2.2MHz, L = 2.2μH

Efficiency vs. Load Current

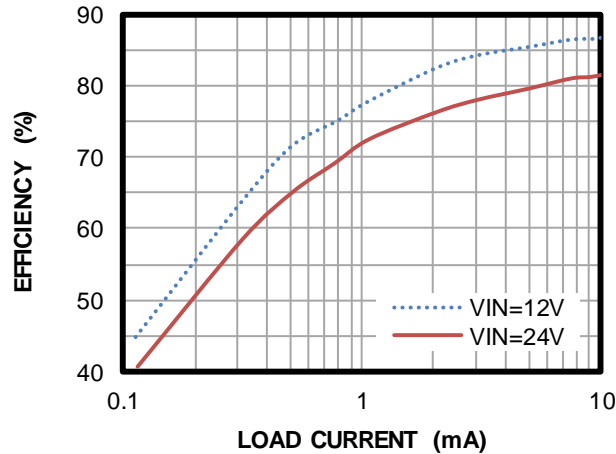
 Extreme light load, V_{OUT} = 3.3V, f_{sw} = 500kHz

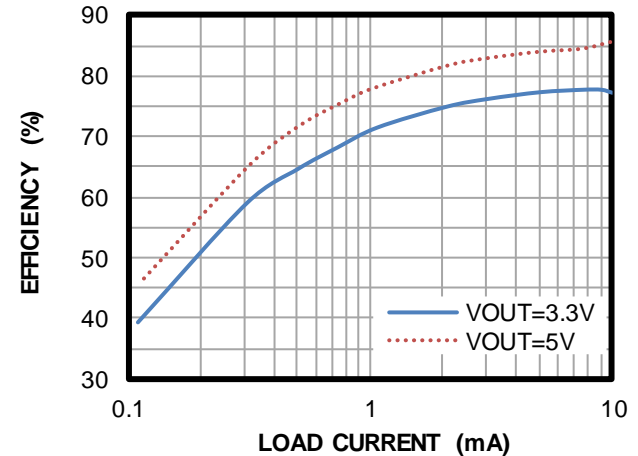
Efficiency vs. Load Current

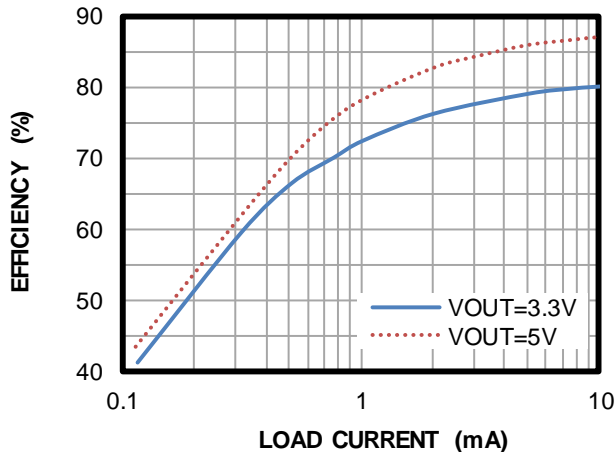
 Extreme light load, V_{OUT} = 5V, f_{sw} = 500kHz

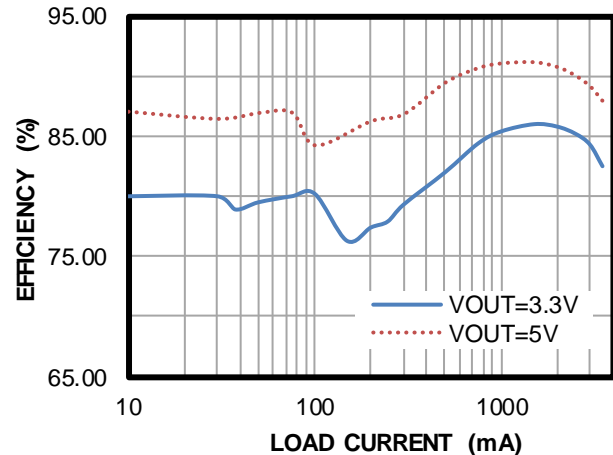
Efficiency vs. Load Current

 Extreme light load, V_{IN} = 14V, f_{sw} = 400kHz

Efficiency vs. Load Current

 Extreme light load, V_{IN} = 14V, f_{sw} = 2.2MHz

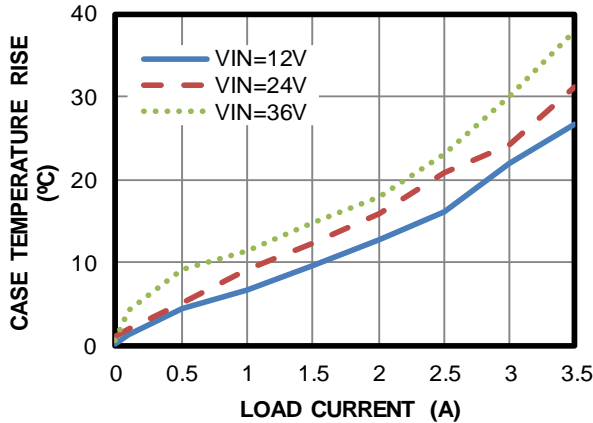
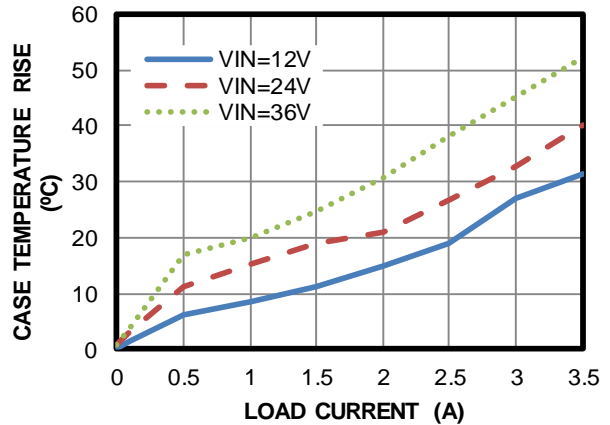
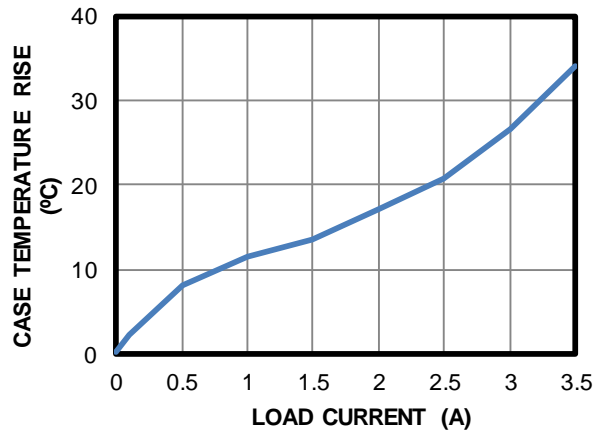
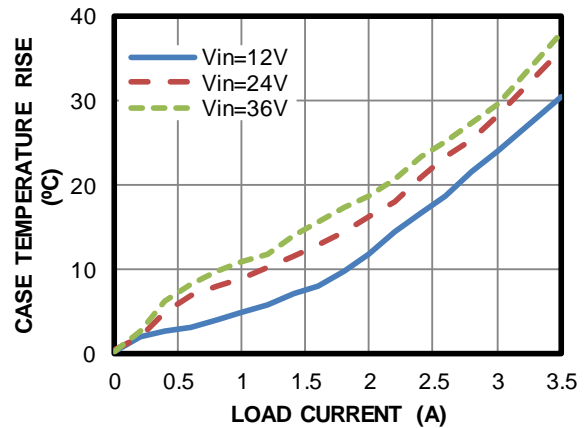
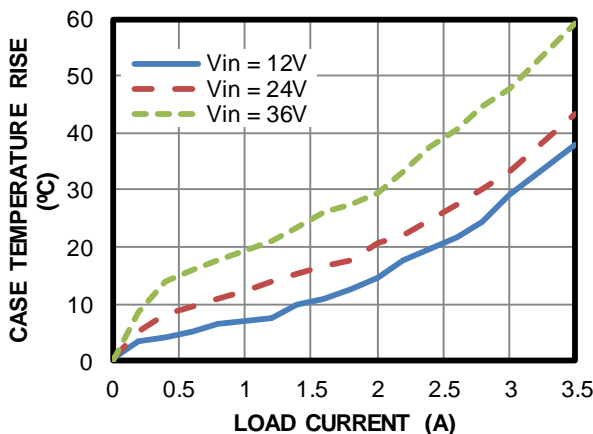
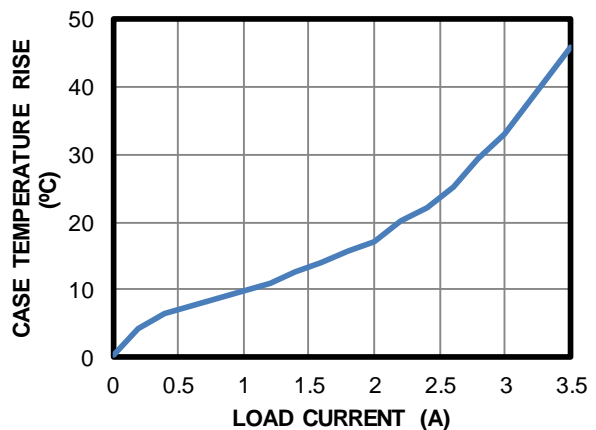
Efficiency vs. Load Current

 V_{IN} = 12V, f_{sw} = 2.2MHz, L = 2.2μH

TYPICAL PERFORMANCE CHARACTERISTICS (continued)
 $V_{IN} = 12V$, $V_{OUT} = 3.3V$, $L = 10\mu H$, $f_{SW} = 500kHz$, $T_A = +25^\circ C$, unless otherwise noted.

Case Temperature Rise vs. Load Current
 $V_{OUT} = 3.3V$, $f_{SW} = 500kHz$

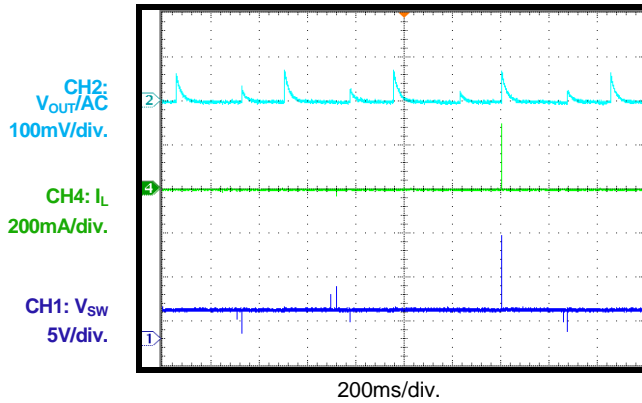
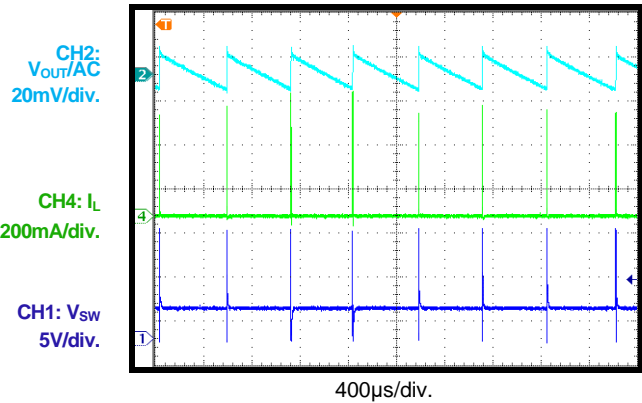
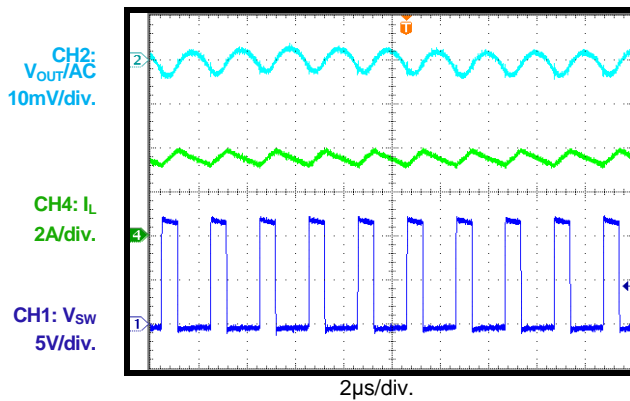
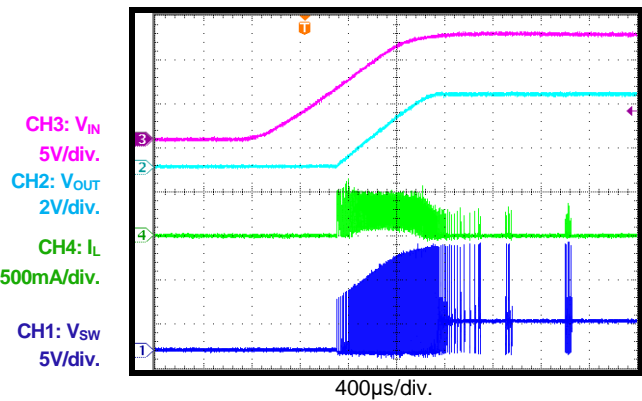
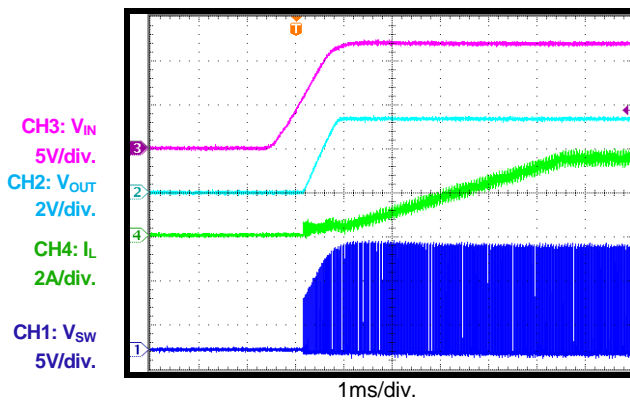
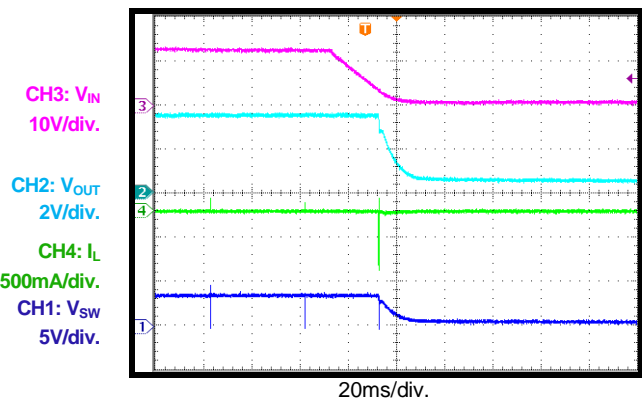
Case Temperature Rise vs. Load Current
 $V_{OUT} = 3.3V$, $f_{SW} = 1MHz$

Case Temperature Rise vs. Load Current
 $V_{OUT} = 3.3V$, $f_{SW} = 2.2MHz$

Case Temperature Rise vs. Load Current
 $V_{OUT} = 5V$, $f_{SW} = 500kHz$

Case Temperature Rise vs. Load Current
 $V_{OUT} = 5V$, $f_{SW} = 1MHz$

Case Temperature Rise vs. Load Current
 $V_{OUT} = 5V$, $f_{SW} = 2.2MHz$

TYPICAL PERFORMANCE CHARACTERISTICS (continued)
 $V_{IN} = 12V$, $V_{OUT} = 3.3V$, $L = 10\mu H$, $f_{SW} = 500kHz$, $T_A = +25^\circ C$, unless otherwise noted.

Steady State
 $I_{OUT} = 0A$

Steady State
 $I_{OUT} = 1mA$

Steady State
 $I_{OUT} = 3.5A$

Start-Up through VIN
 $I_{OUT} = 0A$

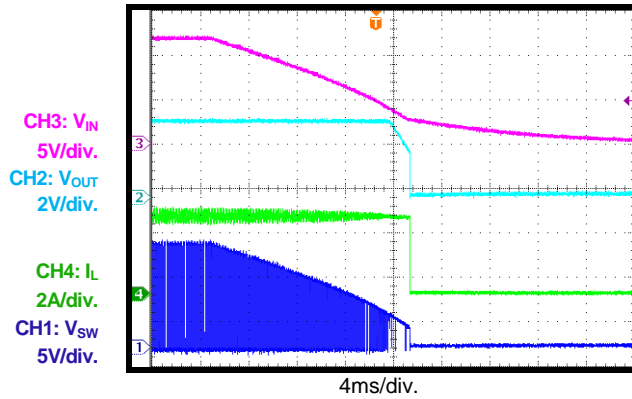
Start-Up through VIN
 $I_{OUT} = 3.5A$

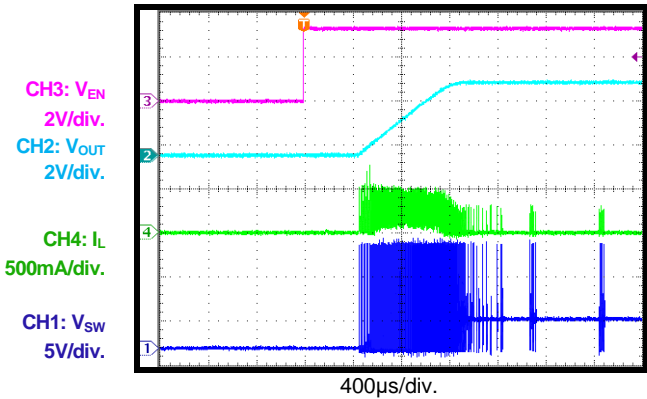
Shutdown through VIN
 $I_{OUT} = 0A$

TYPICAL PERFORMANCE CHARACTERISTICS (continued)

 V_{IN} = 12V, V_{OUT} = 3.3V, L = 10μH, f_{SW} = 500kHz, T_A = +25°C, unless otherwise noted.

Shutdown through VIN

 I_{OUT} = 3.5A

Start-Up through EN

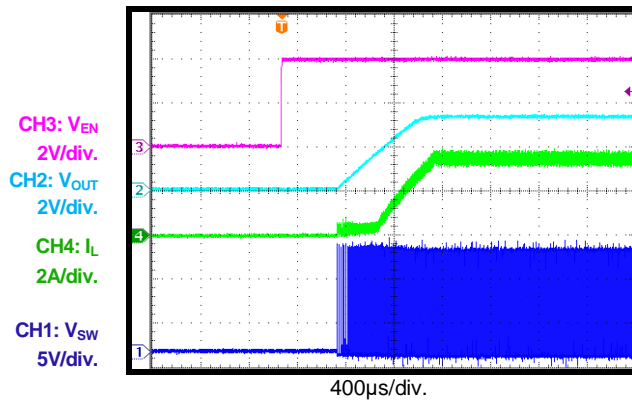
 I_{OUT} = 0A

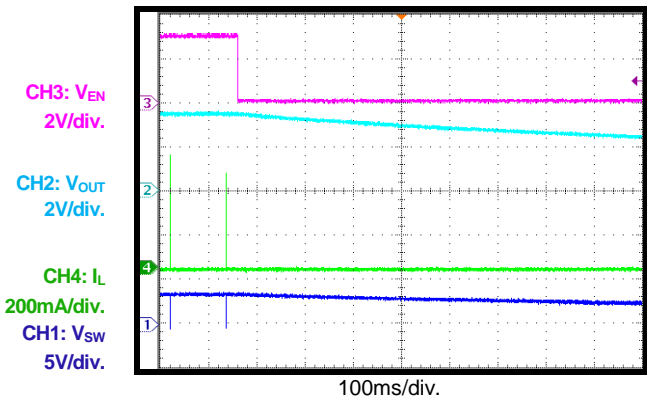
Start-Up through EN

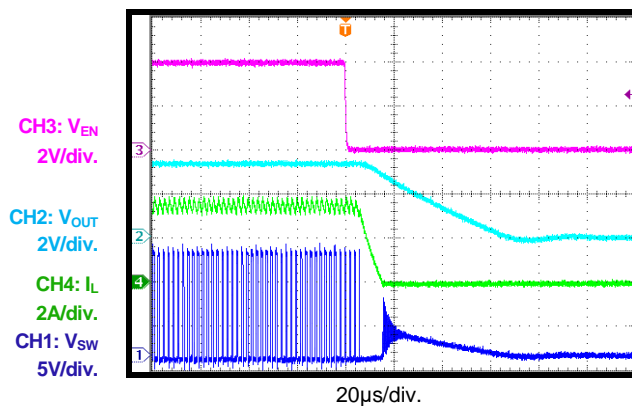
 I_{OUT} = 3.5A

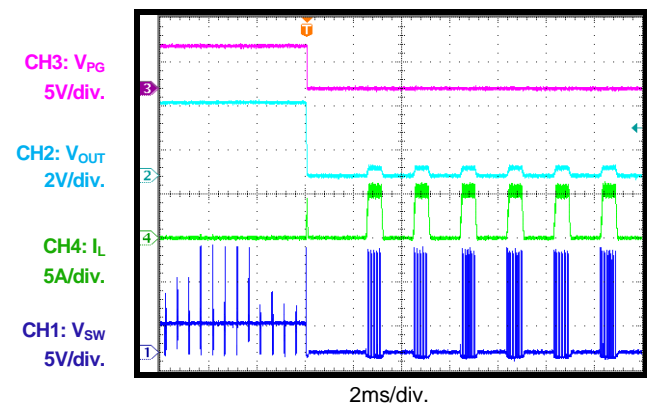
Shutdown through EN

 I_{OUT} = 0A

Shutdown through EN

 I_{OUT} = 3.5A

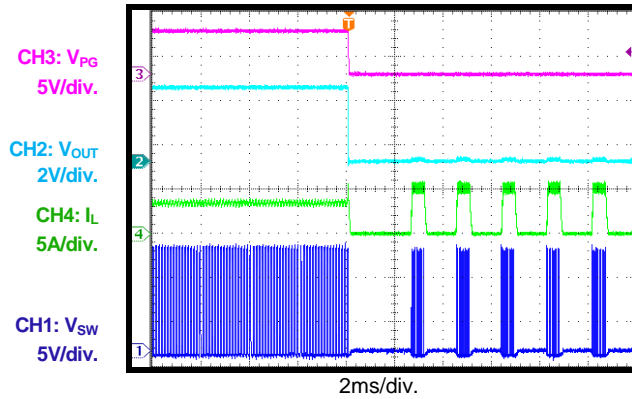
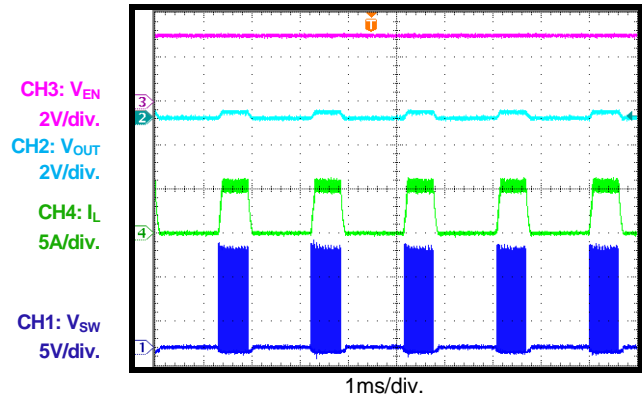
SCP Entry

 I_{OUT} = 0A to short circuit

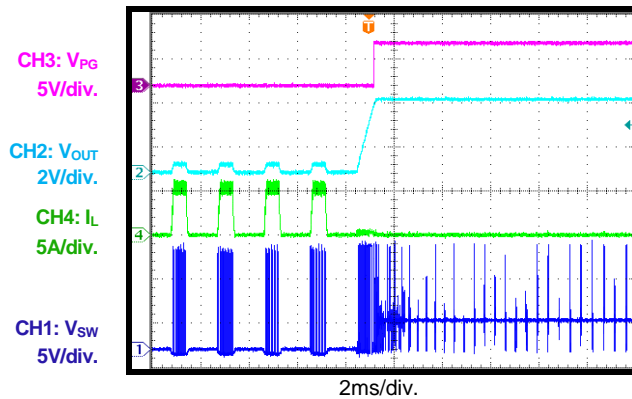
TYPICAL PERFORMANCE CHARACTERISTICS (continued)
 $V_{IN} = 12V$, $V_{OUT} = 3.3V$, $L = 10\mu H$, $f_{SW} = 500kHz$, $T_A = +25^\circ C$, unless otherwise noted.

SCP Entry
 $I_{OUT} = 3.5A$ to short circuit

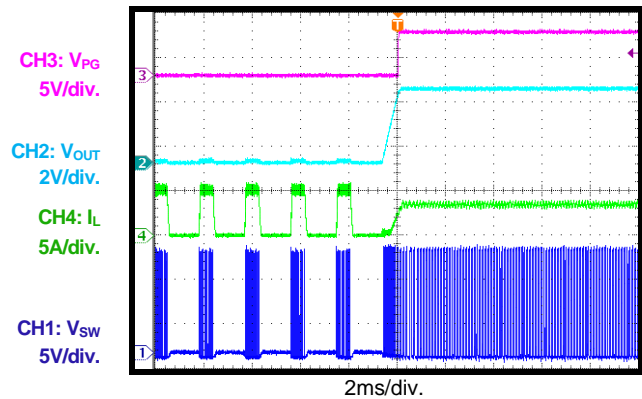
SCP Steady State

SCP Recovery

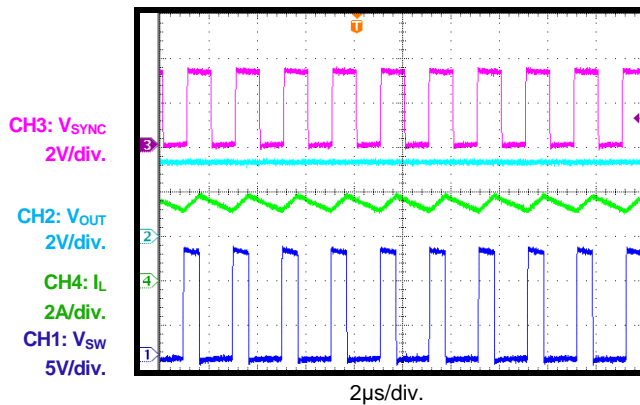
 Short circuit to $I_{OUT} = 0A$

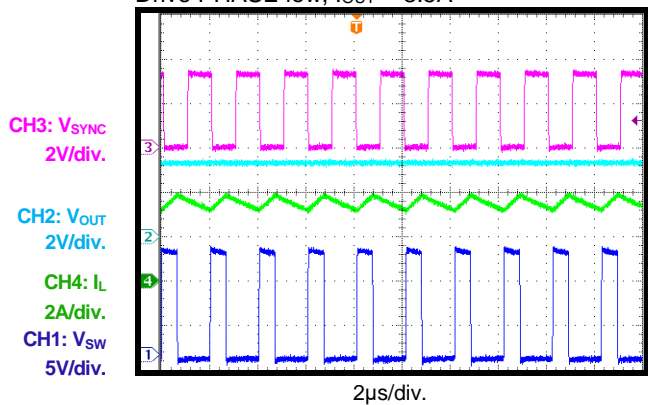
SCP Recovery

 Short circuit to $I_{OUT} = 3.5A$

SYNC Operation (In-Phase)

 Drive PHASE high, $I_{OUT} = 3.5A$

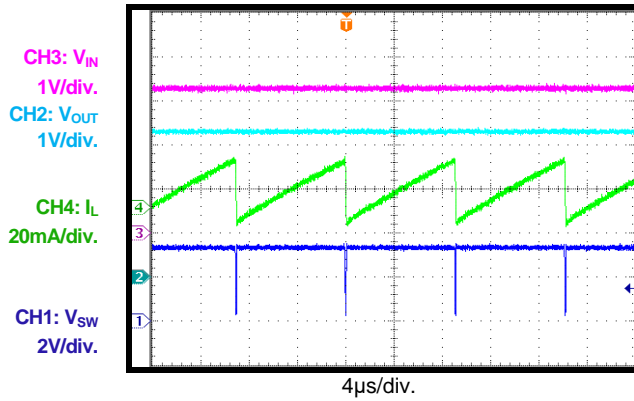
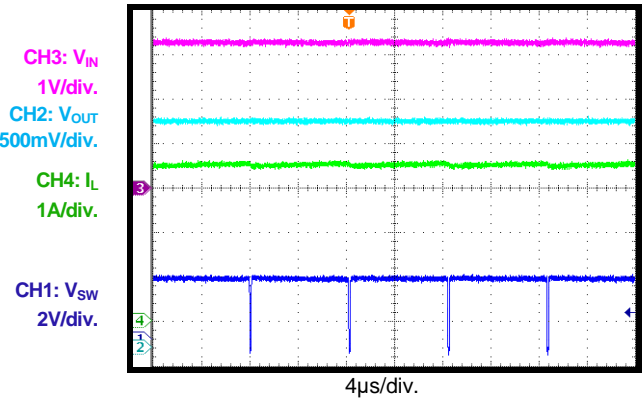
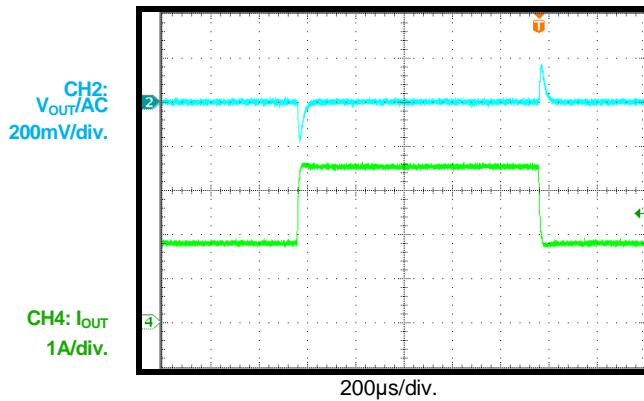
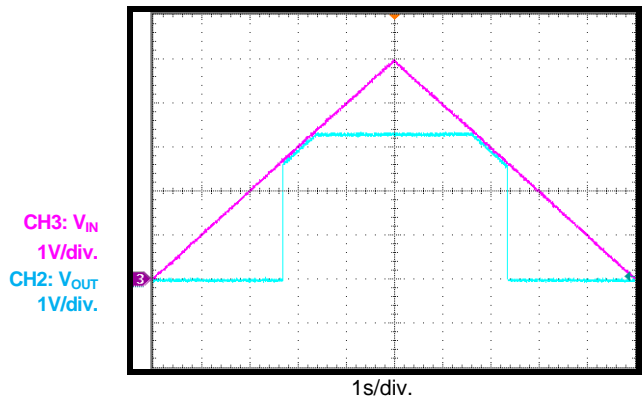
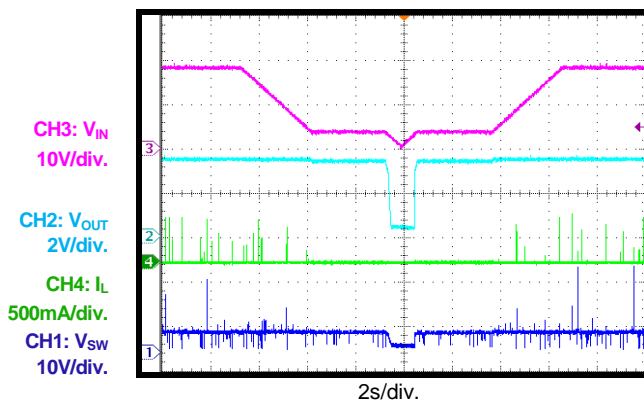
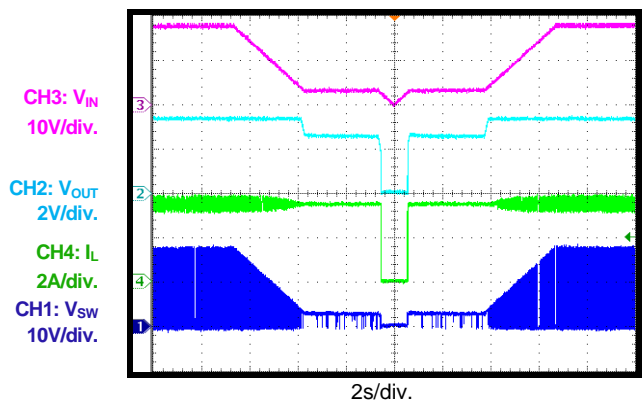
SYNC Operation (180° Out-Of-Phase)

 Drive PHASE low, $I_{OUT} = 3.5A$

TYPICAL PERFORMANCE CHARACTERISTICS (continued)
 $V_{IN} = 12V$, $V_{OUT} = 3.3V$, $L = 10\mu H$, $f_{SW} = 500kHz$, $T_A = +25^\circ C$, unless otherwise noted.

Dropout Operation
 $V_{IN} = 3.3V$, V_{OUT} set to 3.3V, $I_{OUT} = 0A$

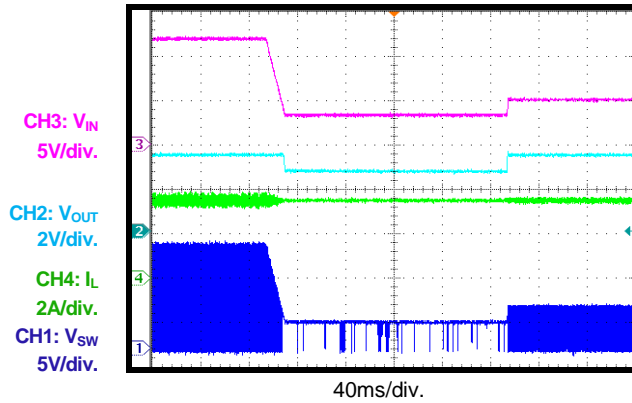
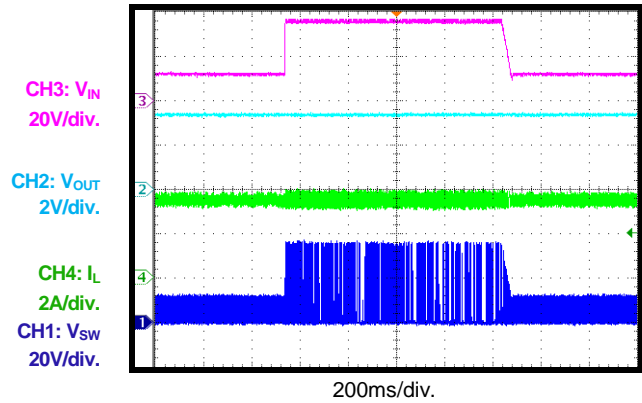
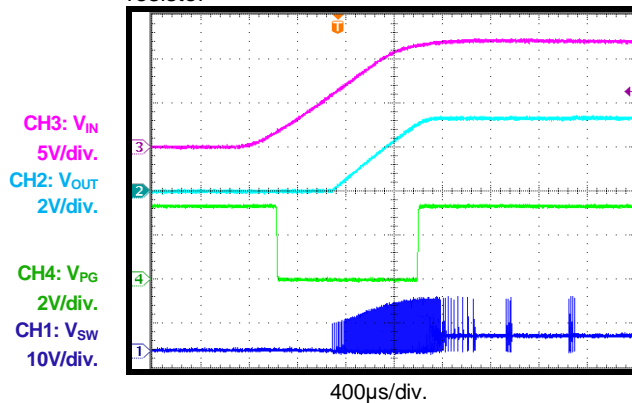
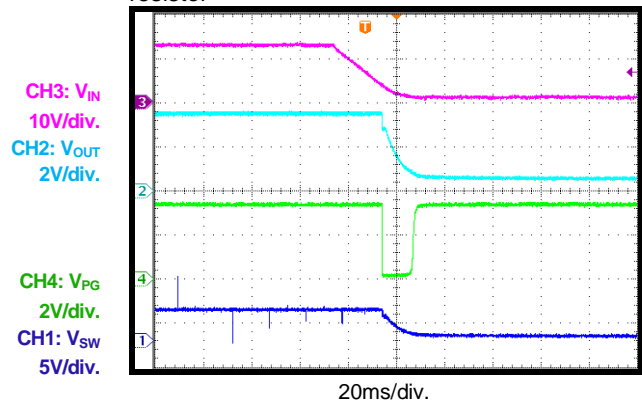
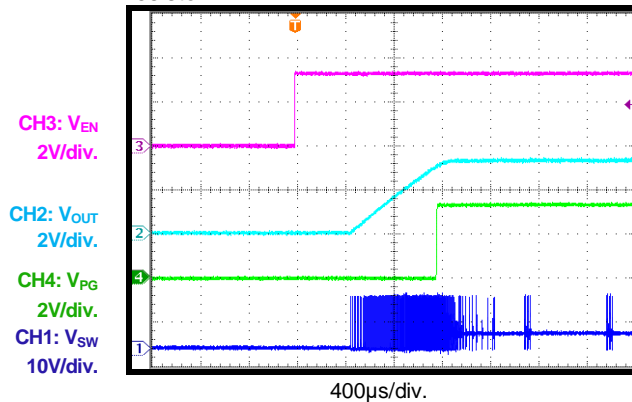
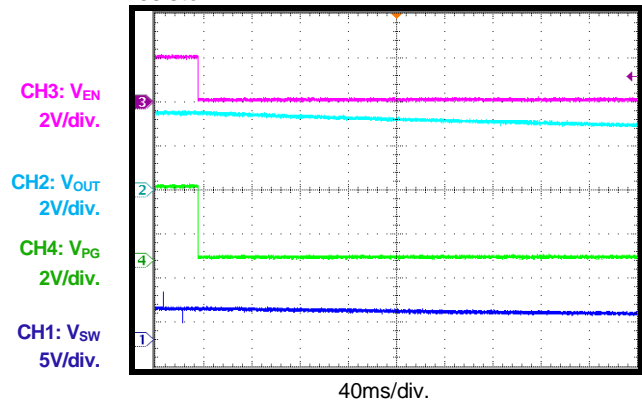
Dropout Operation
 $V_{IN} = 3.3V$, V_{OUT} set to 3.3V, $I_{OUT} = 3.5A$

Load Transient
 $I_{OUT} = 1.75A \rightarrow 3.5A$, $1.6A/\mu s$

VIN Ramp Up and Down
 $I_{OUT} = 0.1A$

VIN Ramp Down and Up
 $I_{OUT} = 1mA$

VIN Ramp Down and Up
 $I_{OUT} = 3.5A$

TYPICAL PERFORMANCE CHARACTERISTICS (continued)
 $V_{IN} = 12V$, $V_{OUT} = 3.3V$, $L = 10\mu H$, $f_{SW} = 500kHz$, $T_A = +25^\circ C$, unless otherwise noted.

Cold Crank
 $V_{IN} = 12V \rightarrow 3.3V \rightarrow 5V$, $I_{OUT} = 3.5A$

Load Dump
 $V_{IN} = 12V \rightarrow 36V$, $I_{OUT} = 3.5A$

PG in Start-Up through VIN
 $I_{OUT} = 0A$, PG is pulled to 3.3V through 100k Ω resistor

PG in Shutdown through VIN
 $I_{OUT} = 0A$, PG is pulled to 3.3V through 100k Ω resistor

PG in Start-Up through EN
 $I_{OUT} = 0A$, PG is pulled to 3.3V through 100k Ω resistor

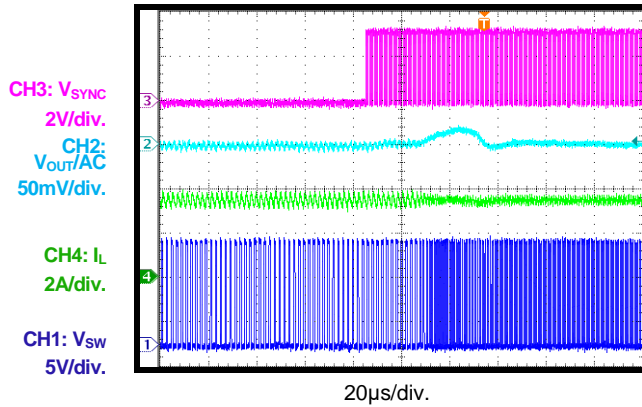
PG in Shutdown through EN
 $I_{OUT} = 0A$, PG is pulled to 3.3V through 100k Ω resistor

TYPICAL PERFORMANCE CHARACTERISTICS *(continued)*

V_{IN} = 12V, V_{OUT} = 3.3V, L = 10μH, f_{SW} = 500kHz, T_A = +25°C, unless otherwise noted.

SYNC In Transient

I_{OUT} = 3.5A, SYNC = 1MHz



SYNC Out Transient

I_{OUT} = 3.5A, SYNC = 1MHz

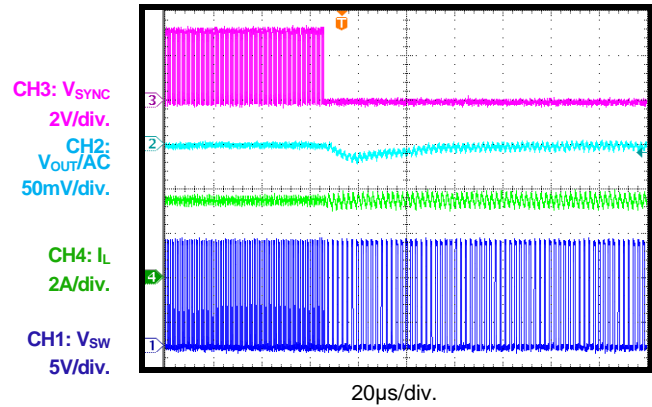

FUNCTIONAL BLOCK DIAGRAM

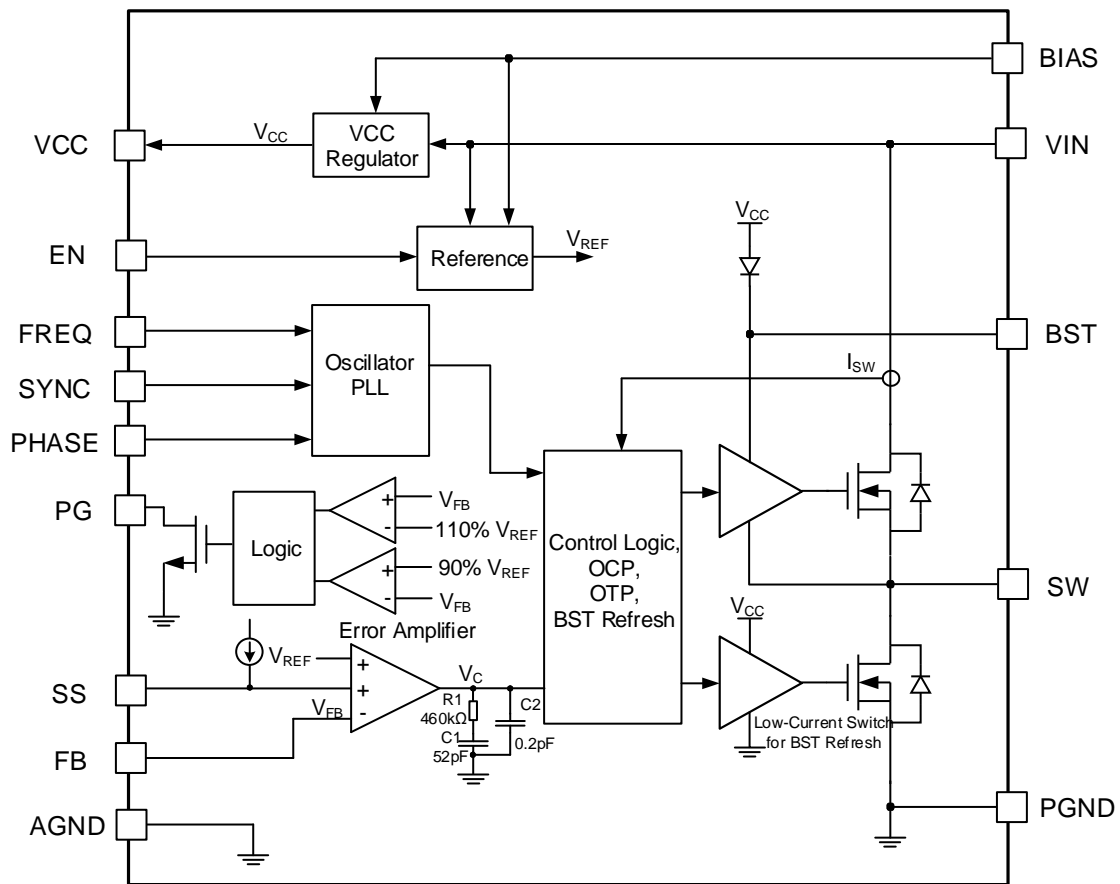

Figure 1: Functional Block Diagram

TIMING SEQUENCE

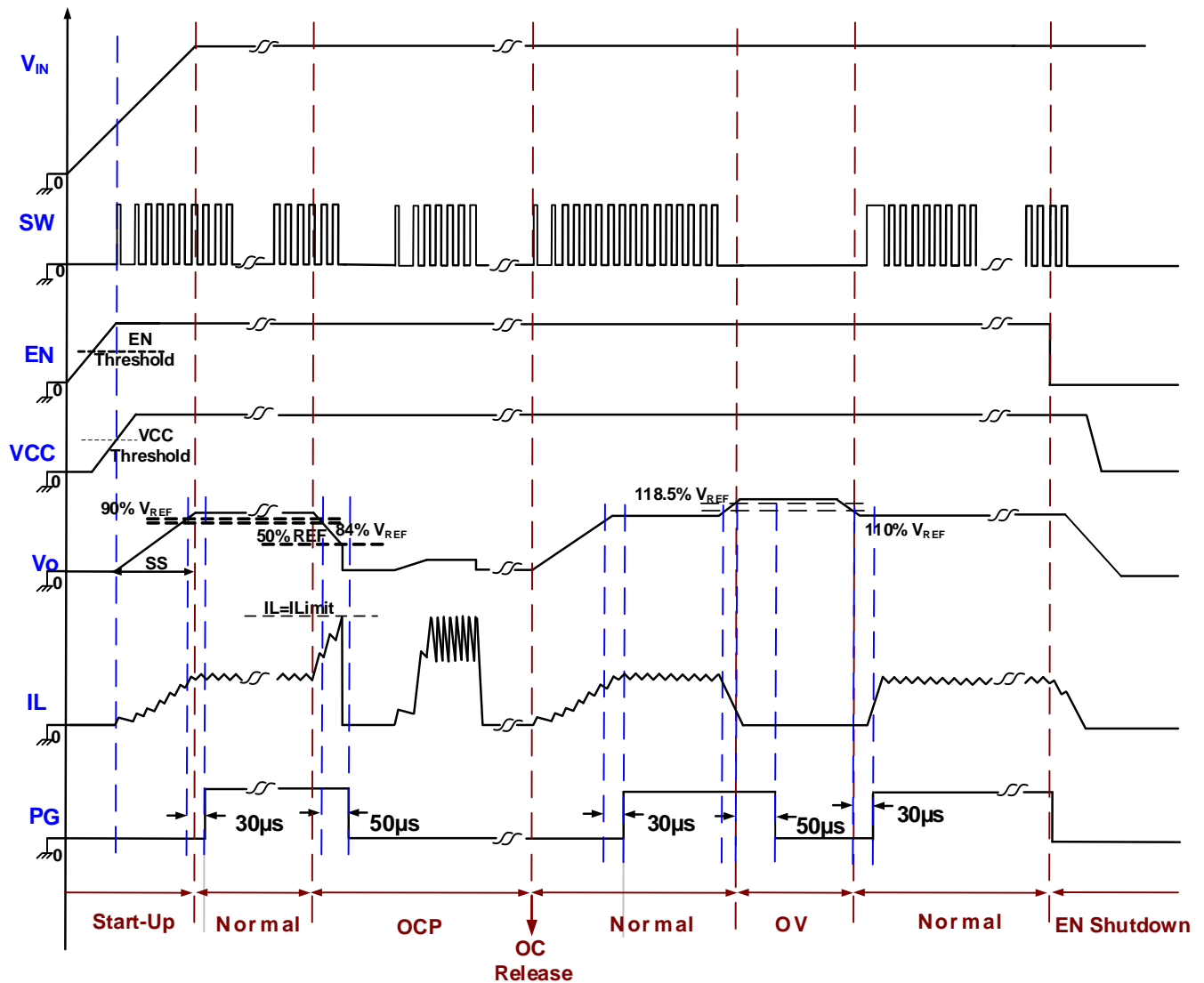

Figure 2: Timing Sequence

OPERATION

The MPQ4468 is a high-frequency, asynchronous, rectified, step-down, switch-mode converter with an integrated internal high-side power MOSFET. Figure 1 shows a block diagram of the device. It offers a very compact solution that achieves 3.5A of continuous output current with excellent load and line regulation over a wide, 3.3V to 36V input supply range.

It features programmable 350kHz to 2.5MHz switching frequency, external soft start, a power good indicator, and precision current limit. Its very low operational quiescent current makes it well-suited for battery powered applications.

PWM (Pulse-Width Modulation) Control

At moderate to high output current, the MPQ4468 operates in a fixed-frequency, peak current control mode to regulate the output voltage. An internal clock initiates a PWM cycle. At the rise edge of the clock, the high-side MOSFET (HS-FET) is turned on, and the inductor current rises linearly to provide energy to the load. The HS-FET remains on until its current reaches the value set by the COMP voltage (V_{COMP}), which is the output of the internal error amplifier. If in one PWM period, the current in the HS-FET does not reach V_{COMP} , the HS-FET remains on, saving a turn-off operation.

When the HS-FET is off, it remains off until the next clock cycle starts. When the HS-FET is off, the inductor current flows through the freewheel diode.

AAM Mode

The MPQ4468 enters discontinuous conduction mode (DCM) operation first as long as inductor current approaches zero at light load. If the load further decreases, or there is no load that brings V_{COMP} below the internally set AAM value (V_{AAM}), the MPQ4468 enters sleep mode, consuming very low quiescent current to further improve the light-load efficiency.

In sleep mode, the internal clock is blocked, and the MPQ4468 skips some pulses. As the FB voltage (V_{FB}) is lower than the internal 0.8V reference (V_{REF}) at this time, V_{COMP} ramps up until it exceeds V_{AAM} . Then the internal clock is reset, and the crossover time is taken as benchmark of the next clock. This control scheme helps achieve high efficiency by scaling down the

frequency to reduce the switching and gate driver losses during light-load or no-load conditions (see Figure 3).

When the output current increases from light-load condition, V_{COMP} becomes larger and the switching frequency increases. If the DC value of V_{COMP} exceeds V_{AAM} , the operation mode resumes DCM or CCM, which has a constant switching frequency.

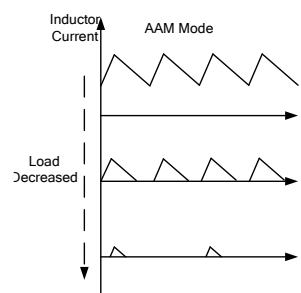

Figure 3: AAM Mode

Error Amplifier (EA)

The error amplifier compares V_{FB} with V_{REF} and outputs a current proportional to the difference between the two. This output current then charges or discharges the internal compensation network to form V_{COMP} , which controls the power MOSFET current. The optimized internal compensation network minimizes the external component counts and simplifies the control loop design.

Internal Regulator and BIAS

Most of the internal circuitry is powered by the 5V internal regulator. This regulator takes V_{IN} as input and operates in the full V_{IN} range. When V_{IN} exceeds 5V, the output of the regulator is in full regulation. When V_{IN} falls below 5V, the output decreases following V_{IN} . A decoupling ceramic capacitor is needed close to the VCC pin.

For better thermal performance, connect BIAS to an external power supply between 5V and 18V. The BIAS supply overrides V_{IN} to power the internal regulator. Using the BIAS supply allows VCC to be derived from a high-efficiency external source, such as V_{OUT} . Float BIAS or connect it to ground if not used.

Under-Voltage Lockout (UVLO)

Under-voltage lockout (UVLO) protects the chip from operating at an insufficient supply voltage. The UVLO comparator monitors the output voltage of the internal regulator (VCC). The UVLO rising threshold is about 2.8V with a 150mV hysteresis.

Enable Control (EN)

EN is a digital control pin that turns the regulator on and off. When EN is pulled below its threshold voltage, the chip is put into the lowest shutdown current mode. Pulling EN above its threshold voltage turns on the part. Do not float EN.

Power Good Indicator (PG)

The MPQ4468 has a power good (PG) indicator. The PG pin is the open drain of a MOSFET. It should be connected to VCC or another voltage source through a resistor (e.g. 100kΩ). In the presence of an input voltage, the MOSFET turns on so that PG is pulled low before SS is ready. When the regulator output is within ±10% of its nominal output, the PG output is pulled high after a delay (typically 30μs). When the output voltage moves outside this range with a hysteresis, the PG output is pulled to low with a 50μs delay to indicate a failure output status.

Programmable Frequency

The oscillating frequency of the MPQ4468 can be programmed either by an external frequency resistor (R_{FREQ}) or by a logic-level synchronous clock. The frequency resistor should be located between FREQ and ground, as close to the device as possible.

The value of R_{FREQ} can be estimated with Equation (1):

$$R_{FREQ}(\text{k}\Omega) = \frac{170000}{f_{SW}^{1.11}(\text{kHz})} \quad (1)$$

The calculated resistance may need fine-tuning by bench test. R_{FREQ} should not be floated, even if an external SYNC clock is added.

SYNC and PHASE

The internal oscillator frequency can also be synchronized to an external clock ranging from 350kHz to 2.5MHz through the SYNC pin. The external clock should be at least 250kHz larger than the R_{FREQ} set frequency. Make sure the high amplitude of the SYNC clock is above 1.8V, and

the low amplitude is below 0.4V. There is no pulse-width requirement, but note that there is always parasitic capacitance of the pad, so if the pulse width is too short, a clear rising and falling edge may not be seen due to the parasitic capacitance. A pulse longer than 100ns is recommended in application.

The PHASE pin is used when two or more MPQ4468s are in parallel with the same sync clock. Pulling PHASE high forces the device to operate in-phase with the SYNC clock. Pulling it low forces the device to be 180° out-of-phase with the SYNC clock. By setting a different PHASE voltage, two devices can operate in 180° out-of-phase to reduce the total input current ripple so a smaller input bypass capacitor can be used (see Figure 4). The PHASE rising threshold is about 2.5V with a 400mV hysteresis.

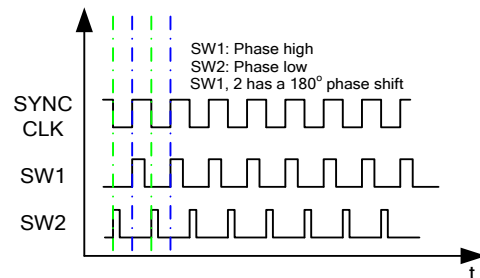

Figure 4: In-Phase and 180° Out-of-Phase

Soft Start (SS)

Soft start (SS) is implemented to prevent the converter output voltage from overshooting during start-up. When the chip starts up, an internal current source begins charging the external soft-start capacitor. The internal SS voltage (V_{SSI}) rises with the soft-start voltage (V_{SS}), but V_{SSI} is slightly different from V_{SS} due to a 0.5V offset and some delay. When V_{SS} is lower than 0.5V, V_{SSI} is 0V. V_{SSI} rises from 0V to 0.8V as V_{SS} rises from 0.5V to 1.6V. During this time, the error amplifier uses V_{SSI} as the reference, and the output voltage ramps up from 0V to the regulated value, following V_{SSI} rising. When V_{SS} reaches 1.6V, V_{SSI} is 0.8V and overrides the internal V_{REF}, so the error amplifier uses the internal V_{REF} as the reference.

To minimize the delay for SS to reach 0.5V, an internal pull-up circuit with about 100μA average current pulls SS up to 0.4V. Then a 10μA constant current charges SS up to about 4V.

The soft-start time (t_{SS}) set by the external SS capacitor can be calculated with Equation (2):

$$t_{SS}(\text{ms}) = \frac{C_{SS}(\text{nF}) \times 1.1\text{V}}{I_{SS}(\mu\text{A})} \quad (2)$$

Where C_{SS} is the external SS capacitor, and I_{SS} is the internal 10 μA SS charge current.

The delay time for SS to reach 0.5V can be estimated with Equation (3):

$$t_{SS_delay}(\text{ms}) = \frac{C_{SS}(\text{nF}) \times 0.4\text{V}}{100\mu\text{A}} + \frac{C_{SS}(\text{nF}) \times 0.1\text{V}}{10\mu\text{A}} \quad (3)$$

SS can be used for tracking and sequencing.

Pre-bias Start-Up

At start-up, if V_{FB} is higher than $V_{SS1} - 150\text{mV}$, which means the output has a pre-bias voltage, the HS-FET does not turn on until $V_{SS1} - 150\text{mV}$ is higher than V_{FB} .

Over-Current Protection (OCP) and Hiccup Mode

The MPQ4468 has cycle-by-cycle peak current limit protection and hiccup mode.

The power MOSFET current is accurately sensed via a current-sense MOSFET. It is then fed to the high-speed current comparator for current-mode control. During the HS-FET on state, if the sensed current exceeds the peak-current limit value set by the COMP high-clamp voltage, the HS-FET turns off immediately. Then the inductor current flows through the external freewheel diode and decreases. The HS-FET remains off until the next clock cycle starts. During OCP, the clock frequency is related to the FB voltage, and decreases as the FB voltage decreases. Both the peak current limit and frequency foldback help keep the inductor current from running away during an overload or short-circuit condition.

When the output is shorted to ground, causing the output voltage to drop below 55% of its nominal output, the peak current limit is kicked. The MPQ4468 considers this an output dead short, and triggers hiccup mode to periodically restart the part.

In hiccup mode, the MPQ4468 disables its output power stage and discharges the soft-start capacitor slowly. The device restarts with a full soft start when the soft-start capacitor is fully discharged. If the short-circuit condition still

remains after the soft start ends, the device repeats this operation until the fault is removed and the output returns to the regulation level. This protection mode greatly reduces the average short-circuit current to alleviate thermal issues and protect the regulator.

Floating Driver and Bootstrap Charging

A 0.1 μF to 1 μF external bootstrap capacitor powers the floating power MOSFET driver. The floating driver has its own UVLO protection with a rising threshold of 2.5V and hysteresis of 200mV.

The bootstrap capacitor voltage is charged to about 5V from VCC through a PMOS pass transistor when the SW node is low.

At high duty cycle operation or in sleep mode condition, the bootstrap charging time period is shorter, so the bootstrap capacitor may not charge sufficiently. If the external circuit does not have sufficient voltage or time to charge the bootstrap capacitor, extra external circuitry can be used to ensure the bootstrap voltage is in the normal operation range.

BST Refresh

To improve dropout, the MPQ4468 is designed to operate at close to 100% duty cycle as long as the BST-to-SW voltage is greater than 2.5V. When the voltage from BST to SW drops below 2.5V, the HS-FET is turned off using an UVLO circuit, which forces an internal low-current switch to pull the SW node low and refresh the charge on the BST capacitor.

Since the supply current sourced from the BST capacitor is low, the HS-FET can remain on for more switching cycles than are required to refresh the capacitor, making the effective duty cycle of the switching regulator high.

The effective duty cycle during the dropout of the regulator is mainly influenced by the voltage drops across the HS-FET, inductor resistance, and PCB resistance.

Thermal Shutdown (TSD)

Thermal shutdown is implemented to prevent thermal runaway. When the silicon die temperature exceeds its upper threshold, the power MOSFET shuts down. When the temperature drops below its lower threshold, the

chip is enabled again.

Start-Up and Shutdown

If both V_{IN} and EN exceed their appropriate thresholds, the chip starts up. The reference block starts first, generating a stable reference voltage and current, and then the internal regulator is enabled. The regulator provides a stable supply for the rest of the circuitries.

While the internal supply rail is up, an internal timer holds the power MOSFET off for about 50 μ s to blank start-up glitches. When the soft-start block is enabled, it holds the SS output low to ensure the rest of the circuitries are ready, then slowly ramps up.

Three events can shut down the chip: V_{IN} low, EN low, and thermal shutdown. During the shutdown procedure, the signaling path is blocked to avoid any fault triggering, then V_{COMP} and the internal supply rail are pulled down. The floating driver is not subject to this shutdown command, but its charging path is disabled.

APPLICATION INFORMATION

Setting the Output Voltage

The external resistor divider connected to the FB pin sets the output voltage (see Figure 5).

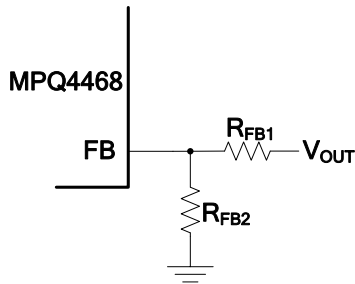

Figure 5: Feedback Network

Set R_{FB1} first. R_{FB2} then can be calculated with Equation (3):

$$R_{FB2} = \frac{R_{FB1}}{\frac{V_{OUT}}{0.8V} - 1} \quad (3)$$

Table 1 lists the recommended feedback resistor values for common output voltages.

Table 1: Resistor Selection for Common Output Voltages

V _{OUT} (V)	R _{FB1} (kΩ)	R _{FB2} (kΩ)
3.3	41.2 (1%)	13 (1%)
5	68.1 (1%)	13 (1%)

Selecting the Input Capacitor

The step-down converter has a discontinuous input current, and requires a capacitor to supply AC current to the converter while maintaining the DC input voltage. For the best performance, use low-ESR capacitors. Ceramic capacitors with X5R or X7R dielectrics are highly recommended because of their low ESR and small temperature coefficients.

For most applications, use a 4.7μF to 10μF capacitor. It is strongly recommended to use another, lower-value capacitor (e.g. 0.1μF) with a small package size (0603) to absorb high-frequency switching noise. Place the small capacitor as close to V_{IN} and GND as possible.

Since C_{IN} absorbs the input switching current, it requires an adequate ripple current rating. The RMS current in the input capacitor can be estimated with Equation (4):

$$I_{CIN} = I_{LOAD} \times \sqrt{\frac{V_{OUT}}{V_{IN}} \times \left(1 - \frac{V_{OUT}}{V_{IN}}\right)} \quad (4)$$

The worst-case condition occurs at V_{IN} = 2V_{OUT}, calculated with Equation (5):

$$I_{CIN} = \frac{I_{LOAD}}{2} \quad (5)$$

For simplification, choose an input capacitor with an RMS current rating greater than half of the maximum load current.

The input capacitor can be electrolytic, tantalum, or ceramic. When using electrolytic or tantalum capacitors, add a small, high-quality ceramic capacitor (e.g. 0.1μF) as close to the IC as possible. When using ceramic capacitors, ensure that they have enough capacitance to provide a sufficient charge to prevent excessive voltage ripple at the input. Estimate the input voltage ripple caused by the capacitance with Equation (6):

$$\Delta V_{IN} = \frac{I_{LOAD}}{f_{SW} \times C_{IN}} \times \frac{V_{OUT}}{V_{IN}} \times \left(1 - \frac{V_{OUT}}{V_{IN}}\right) \quad (6)$$

Selecting the Output Capacitor

The output capacitor maintains the DC output voltage. Use ceramic, tantalum, or low-ESR electrolytic capacitors. For best results, use low-ESR capacitors to keep the output voltage ripple low. The output voltage ripple can be estimated with Equation (7):

$$\Delta V_{OUT} = \frac{V_{OUT}}{f_{SW} \times L} \cdot \left(1 - \frac{V_{OUT}}{V_{IN}}\right) \cdot \left(R_{ESR} + \frac{1}{8f_{SW} \times C_{OUT}}\right) \quad (7)$$

Where L is the inductor value and R_{ESR} is the equivalent series resistance (ESR) value of the output capacitor.

For ceramic capacitors, the capacitance dominates the impedance at the switching frequency and causes the majority of the output voltage ripple. For simplification, the output voltage ripple can be estimated with Equation (8):

$$\Delta V_{OUT} = \frac{V_{OUT}}{8 \times f_{SW}^2 \times L \times C_{OUT}} \times \left(1 - \frac{V_{OUT}}{V_{IN}}\right) \quad (8)$$

For tantalum or electrolytic capacitors, the ESR dominates the impedance at the switching frequency. For simplification, the output ripple can be estimated with Equation (9):

$$\Delta V_{OUT} = \frac{V_{OUT}}{f_{SW} \times L} \times \left(1 - \frac{V_{OUT}}{V_{IN}}\right) \times R_{ESR} \quad (9)$$

The characteristics of the output capacitor also affect the stability of the regulation system. The MPQ4468 can be optimized for a wide range of capacitance and ESR values.

Selecting the Inductor

A 1μH to 10μH inductor with a DC current rating at least 25% higher than the maximum load current is recommended for most applications. For higher efficiency, choose an inductor with lower DC resistance. A larger-value inductor results in less ripple current and a lower output ripple voltage. However, larger-value inductors also have a larger physical size, higher series resistance, and lower saturation current. A good rule for determining the inductor value is to allow the inductor ripple current to be approximately 30% of the maximum load current. The inductance value can then be calculated with Equation (10):

$$L = \frac{V_{OUT}}{f_{SW} \times \Delta I_L} \times \left(1 - \frac{V_{OUT}}{V_{IN}}\right) \quad (10)$$

Where ΔI_L is the peak-to-peak inductor ripple current.

Set the inductor ripple current at approximately 30% of the maximum load current. The maximum inductor peak current can be calculated with Equation (11):

$$I_{LP} = I_{LOAD} + \frac{V_{OUT}}{2f_{SW} \times L} \times \left(1 - \frac{V_{OUT}}{V_{IN}}\right) \quad (11)$$

Selecting the Output Rectifier Diode

The output rectifier diode supplies the current to the inductor when the high-side switch is off. Use a Schottky diode to reduce losses due to the diode forward voltage and recovery times. Choose a diode with a maximum reverse voltage rating greater than the maximum input voltage,

and a current rating greater than the maximum load current.

V_{IN} UVLO Setting

The MPQ4468 has an internal fixed under-voltage lockout (UVLO) threshold. The rising threshold is 2.8V, and the falling threshold is about 2.65V. For applications that require a higher UVLO point, an external resistor divider between V_{IN} and EN can be used to achieve a higher equivalent UVLO threshold (see Figure 6).

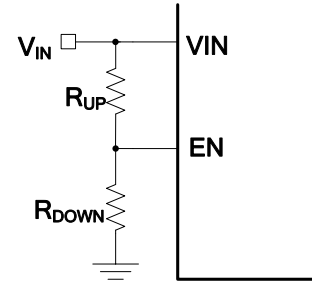

Figure 6: Adjustable UVLO Using EN Divider

The UVLO threshold can be calculated with Equation (12) and Equation (13):

$$INUV_{RISING} = \left(1 + \frac{R_{UP}}{R_{DOWN}}\right) \times V_{EN_RISING} \quad (12)$$

$$INUV_{FALLING} = \left(1 + \frac{R_{UP}}{R_{DOWN}}\right) \times V_{EN_FALLING} \quad (13)$$

Where $V_{EN_RISING} = 1.05V$, and $V_{EN_FALLING} = 0.93V$.

External BST Diode and Resistor

An external BST diode can enhance the efficiency of the regulator when the duty cycle is high. A power supply between 2.5V and 5V can be used to power the external bootstrap diode. VCC or V_{OUT} is recommended to be this power supply in the circuit (see Figure 7).

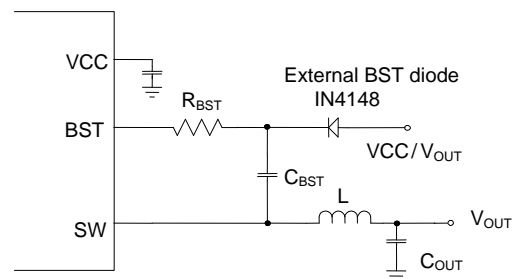

Figure 7: Optional External Bootstrap Diode to Enhance Efficiency

The recommended external BST diode is IN4148, and the recommended BST capacitor value range is 0.1 μ F to 1 μ F. A resistor in series with the BST capacitor (R_{BST}) can reduce the SW rising rate and voltage spikes. This enhances EMI performance and reduces the voltage stress at high V_{IN} . A higher resistance benefits SW spike reduction, but compromises efficiency. To make a tradeoff between EMI and efficiency, a $\leq 20\Omega$ R_{BST} is recommended.

PCB Layout Guidelines ⁽⁷⁾

Efficient PCB layout, especially input capacitor placement, is critical for stable operation. A 4-layer layout is strongly recommended to achieve better thermal performance. For best results, refer to Figure 8 and follow the guidelines below:

1. Place symmetric input capacitors as close to V_{IN} and GND as possible.
2. Use a large ground plane to connect directly to PGND. If the bottom layer is a ground plane, add vias near PGND.
3. Ensure that the high-current paths at GND and V_{IN} have short, direct, and wide traces.
4. Place the ceramic input capacitor, especially the small package size (0603) input bypass capacitor, as close to V_{IN} and PGND as possible to minimize high-frequency noise.
5. Keep the connection between the input capacitor and IN as short and wide as possible.
6. Place the VCC capacitor as close to the VCC and GND pins as possible.
7. Route SW and BST away from sensitive analog areas, such as FB.
8. Place the FB resistors as close to the chip as possible to keep the trace connecting FB as short as possible.
9. Use a 4-layer layout to achieve better thermal performance. Use multiple vias to connect the power planes to internal layers.

NOTE:

7) The recommended PCB layout is based on Figure 9.

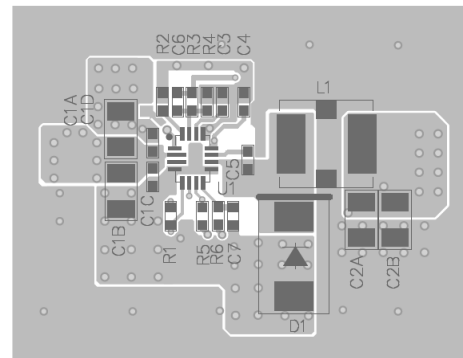

Top Layer

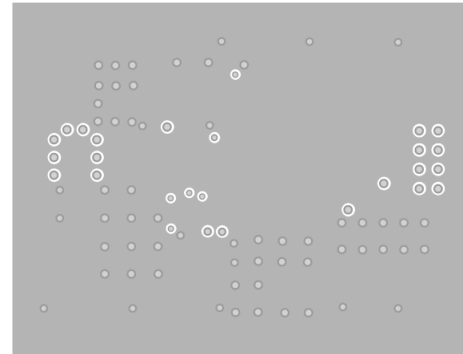

Inner Layer 1

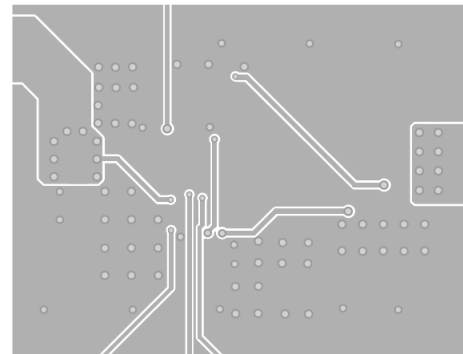

Inner Layer 2

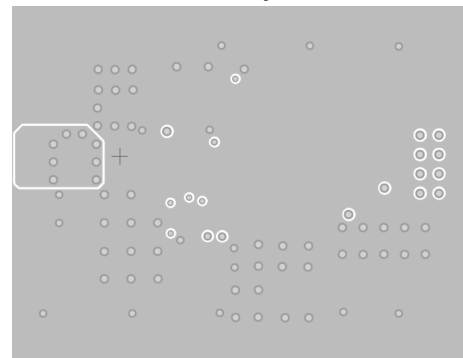

Bottom Layer

Figure 8: Recommended PCB Layout

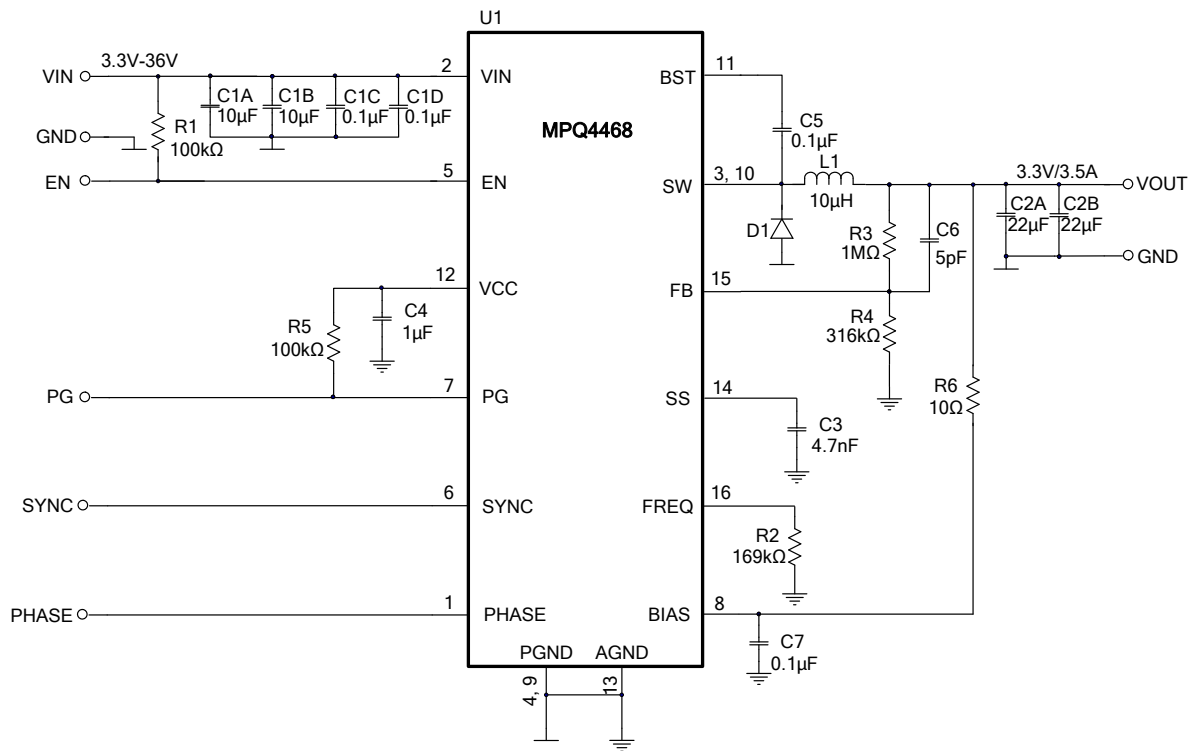
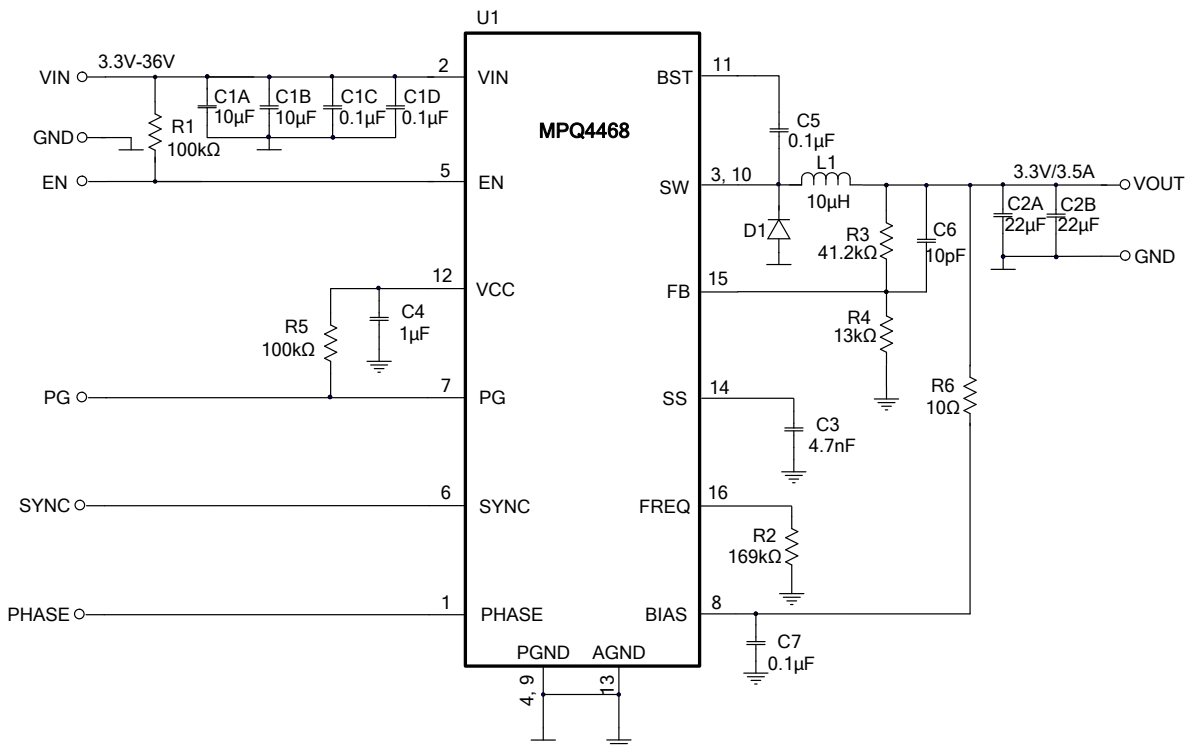
TYPICAL APPLICATION CIRCUITS

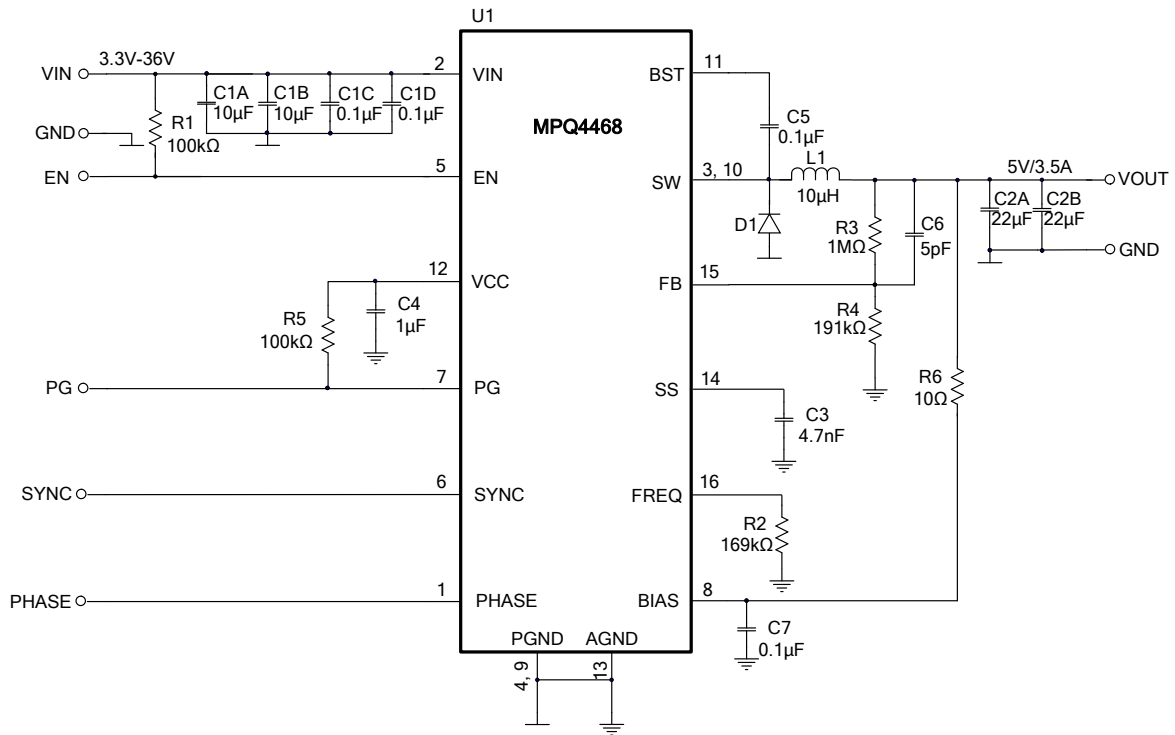
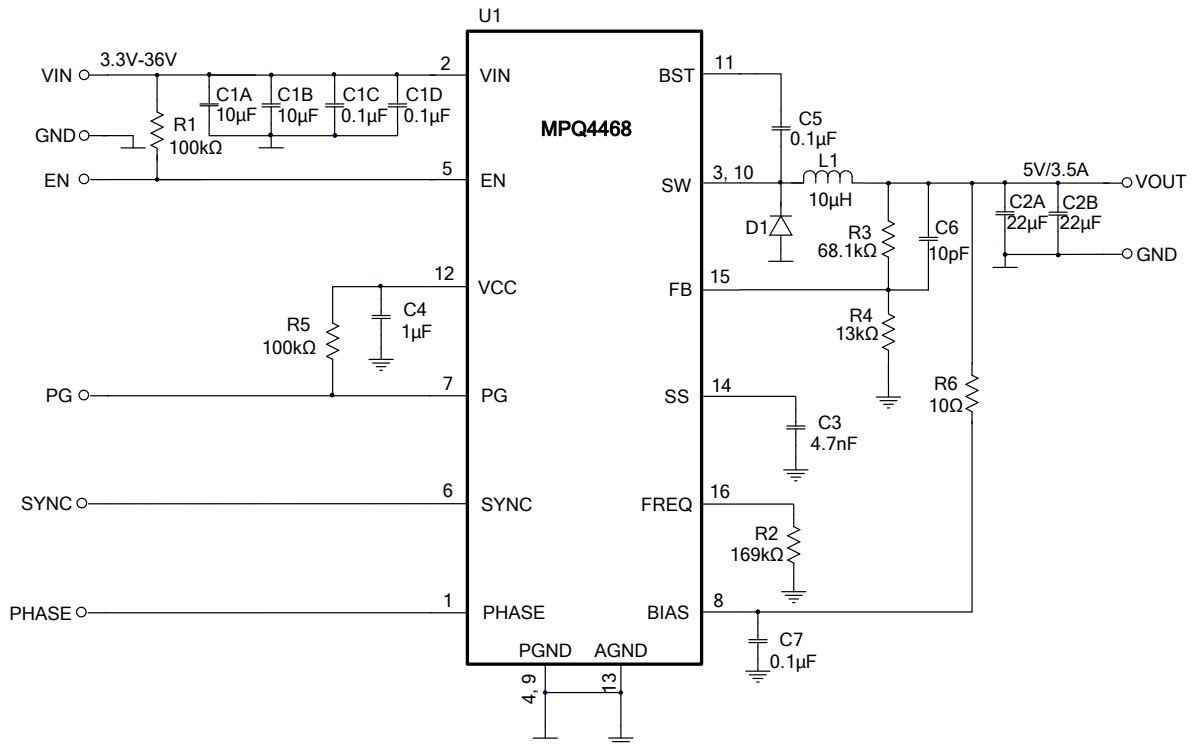
Figure 9: V_{OUT} = 3.3V, f_{sw} = 500kHz

Figure 10: V_{OUT} = 3.3V, f_{sw} = 500kHz for <100kΩ FB Divider Application

Figure 11: $V_{OUT} = 5V$, $f_{sw} = 500kHz$

Figure 12: $V_{OUT} = 5V$, $f_{sw} = 500kHz$ for $<100k\Omega$ FB Divider Application

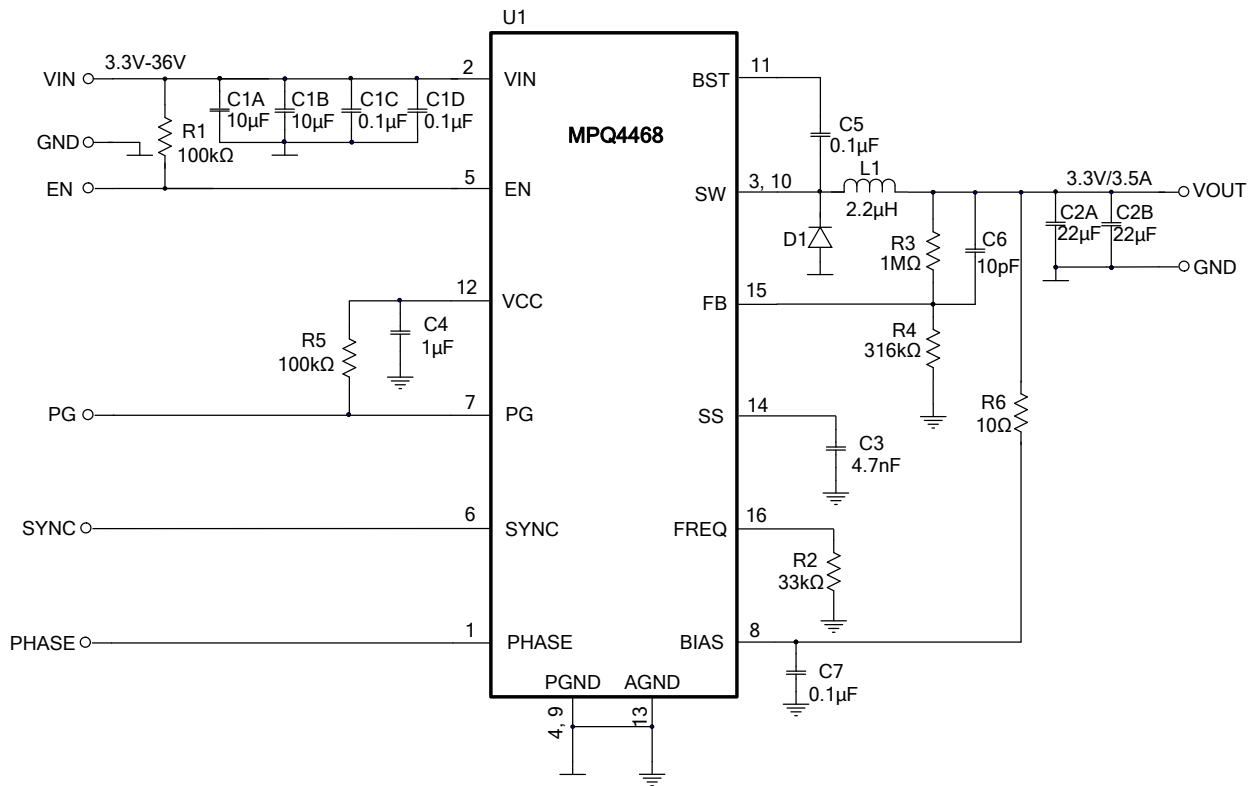

Figure 13: V_{OUT} = 3.3V, f_{sw} = 2.2MHz

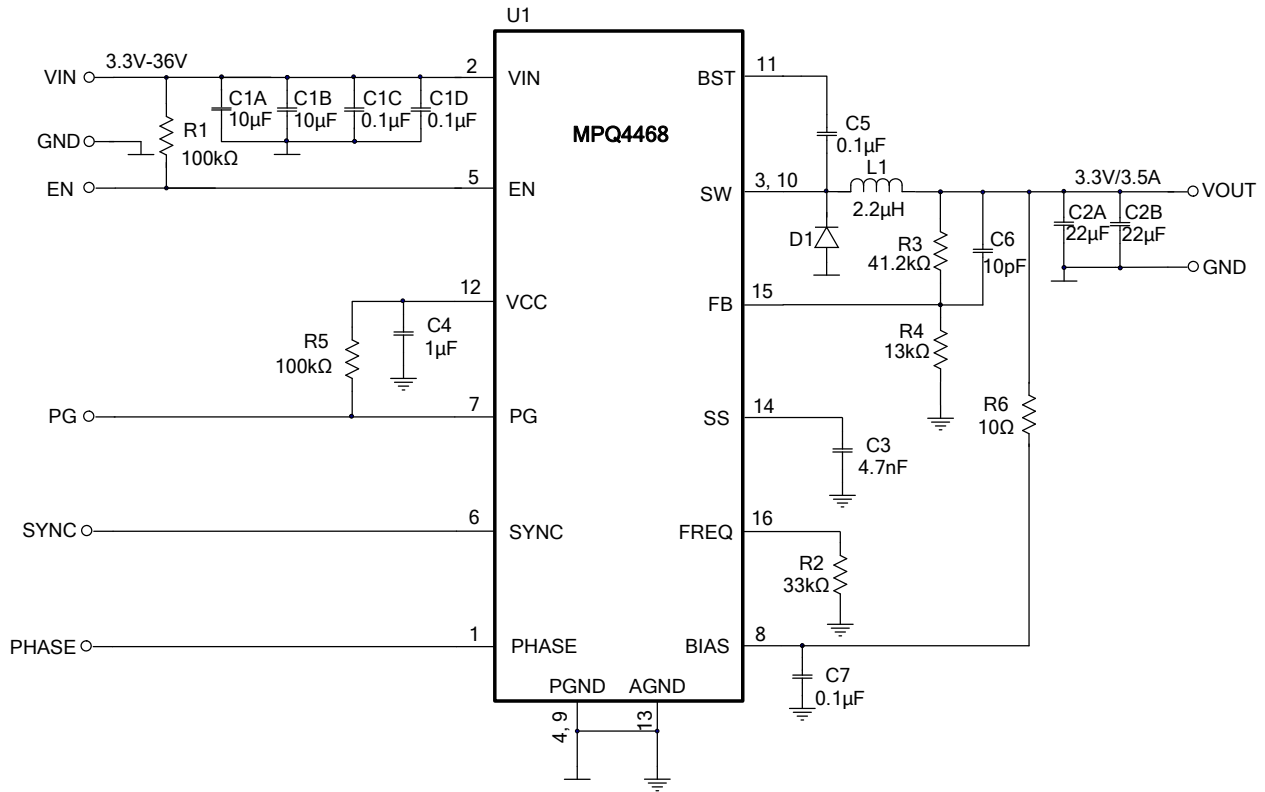
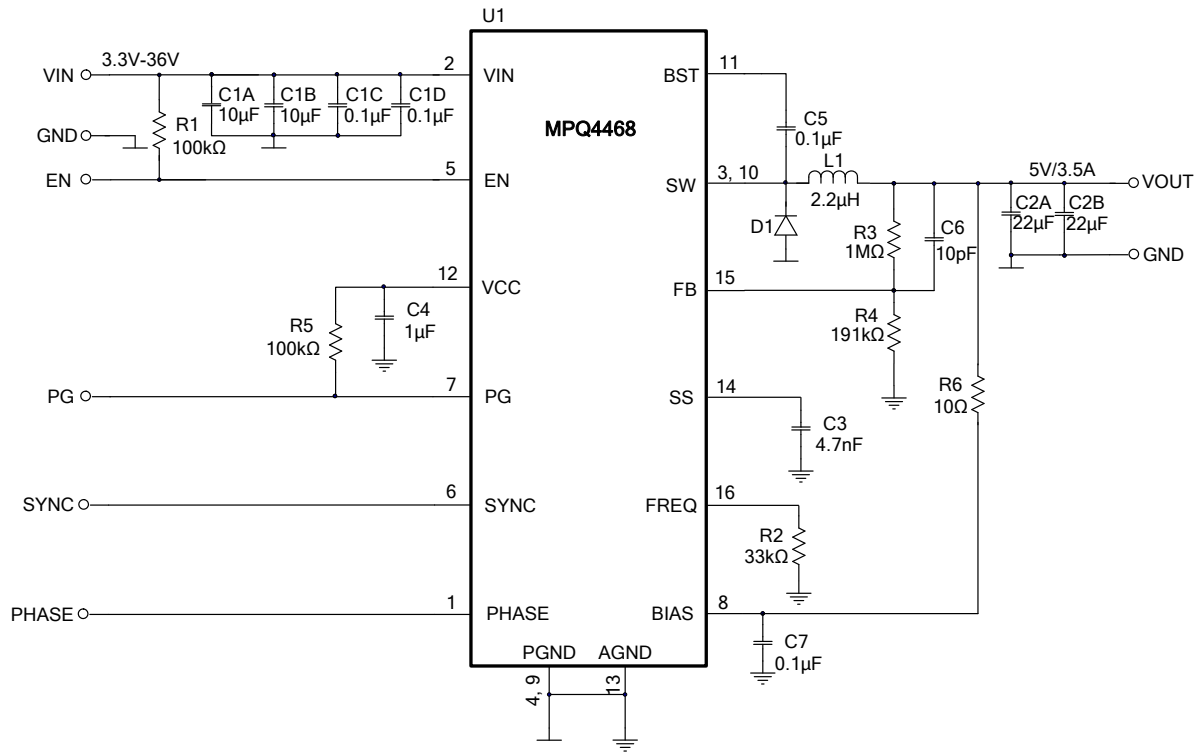
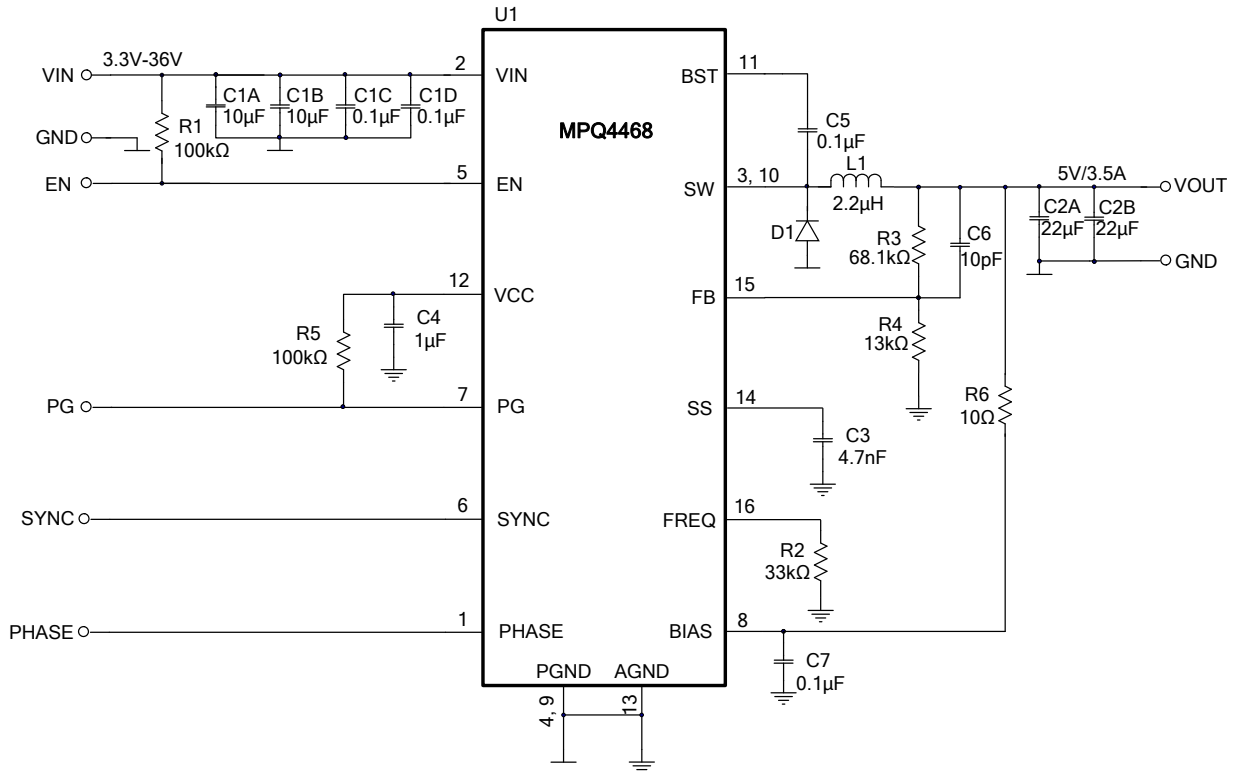
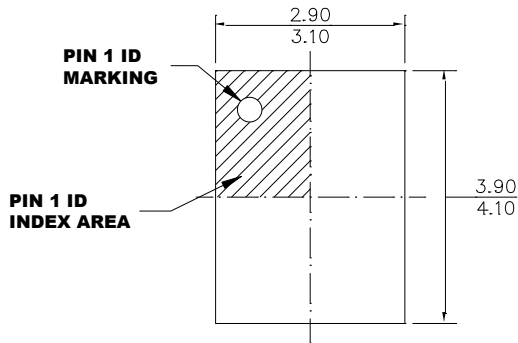

Figure 14: V_{OUT} = 3.3V, f_{sw} = 2.2MHz for <100kΩ FB Divider Application

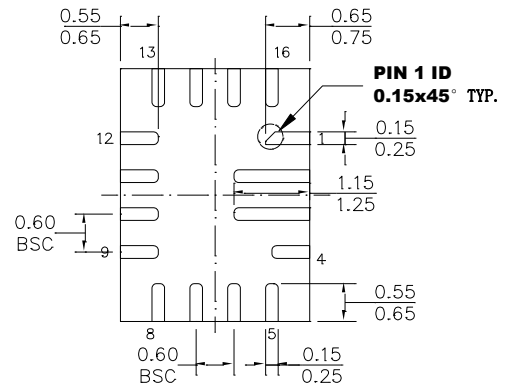

Figure 15: V_{OUT} = 5V, f_{sw} = 2.2MHz

Figure 16: V_{OUT} = 5V, f_{sw} = 2.2MHz for <100kΩ FB Divider Application

PACKAGE INFORMATION

QFN-16 (3mmx4mm)



TOP VIEW



BOTTOM VIEW

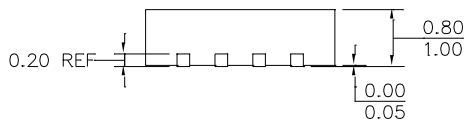

SIDE VIEW

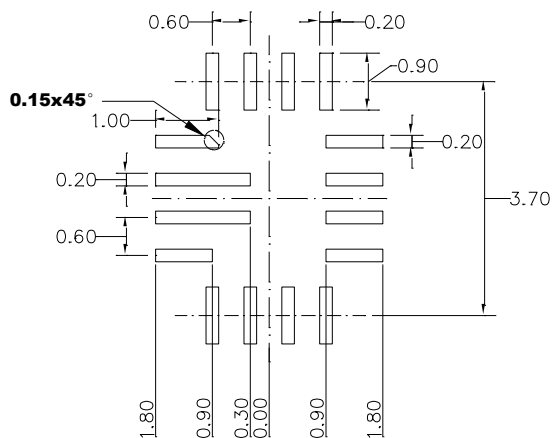

RECOMMENDED LAND PATTERN

NOTE:

- 1) ALL DIMENSIONS ARE IN MILLIMETERS.
- 2) LEAD COPLANARITY SHALL BE 0.10 MILLIMETERS MAX.
- 3) JEDEC REFERENCE IS MO-220.
- 4) DRAWING IS NOT TO SCALE.

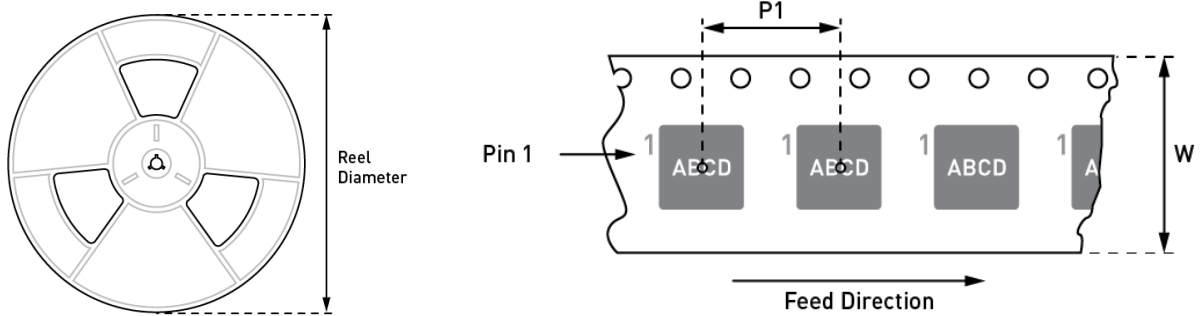
CARRIER INFORMATION

Part Number	Package Description	Quantity /Reel	Reel Diameter	Carrier Tape Width	Carrier Tape Pitch
MPQ4468GL-AEC1	QFN-16 (3mmx4mm)	5000	13in.	12mm	8mm

NOTICE: The information in this document is subject to change without notice. Please contact MPS for current specifications. Users should warrant and guarantee that third-party Intellectual Property rights are not infringed upon when integrating MPS products into any application. MPS will not assume any legal responsibility for any said applications.