

Dual 3A Peak Low-Side MOSFET Drivers

Features

- Reliable, Low-Power Bipolar/CMOS/DMOS Construction
- Latch-Up Protected to >500 mA Reverse Current
- Logic Input withstands Swing to -5V
- High 3A Peak Output Current
- Wide 4.5V to 18V Operating Range
- Drives 1800 pF Capacitance in 25 ns
- Short <40 ns Typical Delay Time
- Delay Times Consistent within Supply Voltage Change
- Matched Rise and Fall Times
- TTL Logic Input Independent of Supply Voltage
- Low Equivalent 6 pF Input Capacitance
- Low Supply Current
 - 3.5 mA with Logic 1 Input
 - 350 μ A with Logic 0 Input
- Low 3.5 Ω Typical Output Impedance
- Output Voltage Swings within 25 mV of Ground or V_S .
- '426/7/8-, '1426/7/8-, '4426/7/8-Compatible Pinout
- Inverting, Non-Inverting, and Differential Configurations

General Description

The MIC4423/4424/4425 family are highly reliable BiCMOS/DMOS buffer/driver/MOSFET drivers. They are higher output current versions of the MIC4426/4427/4428, which are improved versions of the MIC426/427/428. All three families are pin compatible. The MIC4423/4424/4425 drivers are capable of giving reliable service in more demanding electrical environments than their predecessors. They will not latch under any conditions within their power and voltage ratings. They can survive up to 5V of noise spiking, of either polarity, on the ground pin. They can accept, without either damage or logic upset, up to half an amp of reverse current (either polarity) forced back into their outputs.

The MIC4423/4424/4425 series drivers are easier to use, more flexible in operation, and more forgiving than other CMOS or bipolar drivers currently available. Their BiCMOS/DMOS construction dissipates minimum power and provides rail-to-rail voltage swings.

Primarily intended for driving power MOSFETs, the MIC4423/4424/4425 drivers are suitable for driving other loads (capacitive, resistive, or inductive) which require low-impedance, high peak currents, and fast switching times. Heavily loaded clock lines, coaxial cables, or piezoelectric transducers are some examples. The only known limitation on loading is that total power dissipated in the driver must be kept within the maximum power dissipation limits of the package.

See MIC4123/4124/4125 for high power and narrow pulse applications.

Package Types

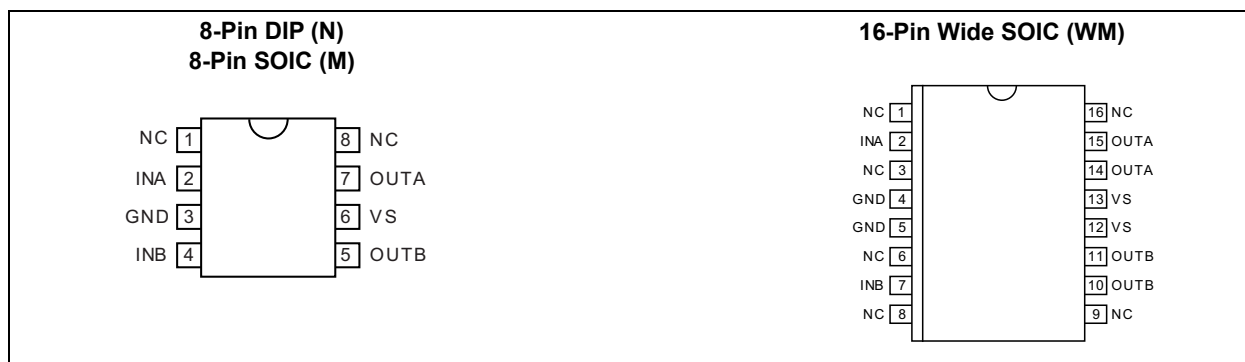

Note: WM Package: Duplicate GND, V_S , OUTA, and OUTB pins must be externally connected together.

MIC4423/4/5

Block Diagram

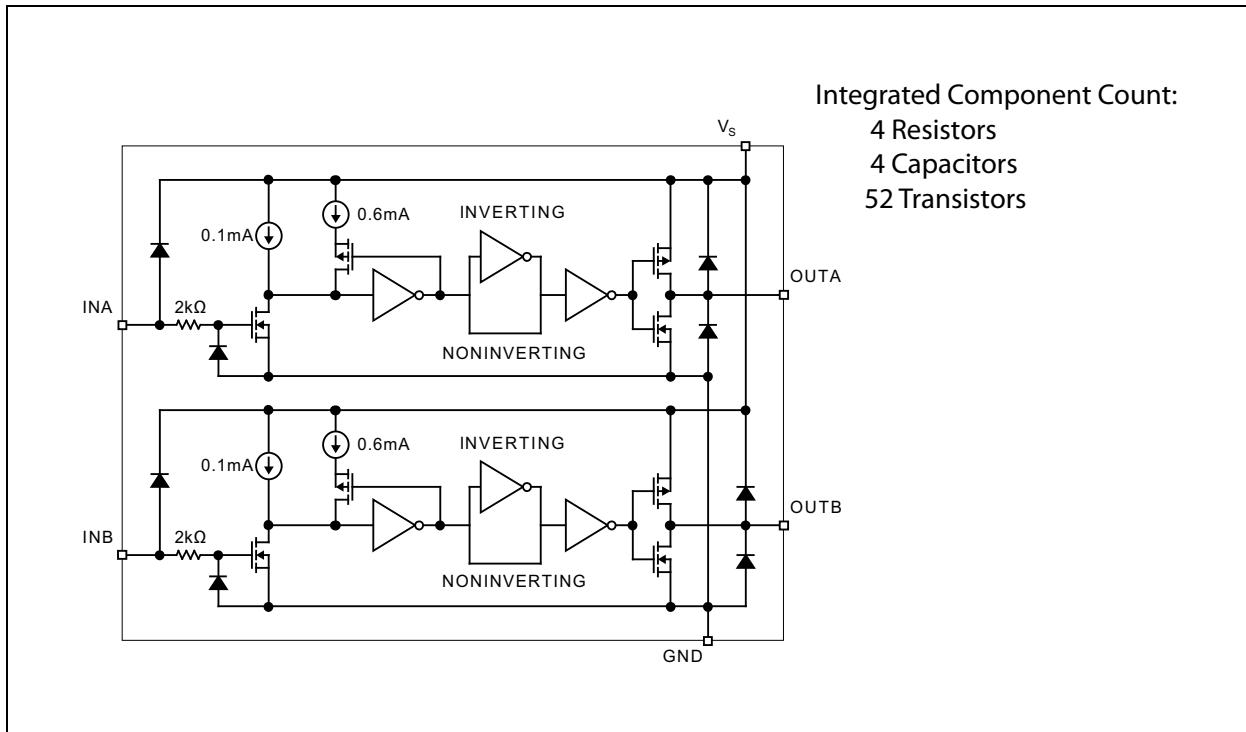

1.0 ELECTRICAL CHARACTERISTICS

Absolute Maximum Ratings †

Supply Voltage	+22V
Input Voltage	$V_S + 0.3V$ to GND $-5V$
Junction Temperature	+150°C
Storage Temperature Range	-65°C to +150°C
Lead Temperature (10 sec.)	+300°C
ESD Susceptibility, (Note 1)	1000V

Operating Ratings ‡

Supply Voltage (V_S)	+4.5V to +18V
Package Thermal Resistance	
DIP θ_{JA}	130°C/W
DIP θ_{JC}	42°C/W
Wide-SOIC θ_{JA}	120°C/W
Wide-SOIC θ_{JC}	75°C/W
SOIC θ_{JA}	120°C/W
SOIC θ_{JC}	75°C/W

† **Notice:** Stresses above those listed under “Absolute Maximum Ratings” may cause permanent damage to the device. This is a stress rating only and functional operation of the device at those or any other conditions above those indicated in the operational sections of this specification is not intended. Exposure to maximum rating conditions for extended periods may affect device reliability. Specifications are for packaged product only.

‡ **Notice:** The device is not guaranteed to function outside its operating ratings.

Note 1: Devices are ESD sensitive. Handling precautions are recommended. Human body model, 1.5 k Ω in series with 100 pF.

TABLE 1-1: ELECTRICAL CHARACTERISTICS

Electrical Characteristics: $4.5V \leq V_S \leq 18V$; $T_A = +25^\circ\text{C}$, **Bold** values indicate $-40^\circ\text{C} \leq T_A \leq +85^\circ\text{C}$; unless otherwise specified. Specifications for packaged product only.

Parameter	Symbol	Min.	Typ.	Max.	Units	Conditions
Input						
Logic 1 Input Voltage	V_{IH}	2.4	—	—	V	—
Logic 0 Input Voltage	V_{IL}	—	—	0.8	V	—
Input Current	I_{IN}	-1	—	1	μA	$0V \leq V_{IN} \leq V_S$
		-10	—	10		—
Output						
High Output Voltage	V_{OH}	$V_S - 0.025$	—	—	V	—
Low Output Voltage	V_{OL}	—	—	0.025	V	—
Output Resistance HI State	R_O	—	2.8	5	Ω	$I_{OUT} = 10 \text{ mA}$, $V_S = 18V$
		—	3.7	8	Ω	$V_{IN} = 0.8V$, $I_{OUT} = 10 \text{ mA}$, $V_S = 18V$
—		3.5	5	Ω	$I_{OUT} = 10 \text{ mA}$, $V_S = 18V$	
Output Resistance LO State		—	4.3	8	Ω	$V_{IN} = 2.4V$, $I_{OUT} = 10 \text{ mA}$, $V_S = 18V$
Peak Output Resistance	I_{PK}	—	3	—	A	—
Latch-Up Protection Withstand Reverse Current	I	>500	—	—	mA	—

MIC4423/4/5

Electrical Characteristics: $4.5V \leq V_S \leq 18V$; $T_A = +25^\circ C$, **Bold** values indicate $-40^\circ C \leq T_A \leq +85^\circ C$; unless otherwise specified. Specifications for packaged product only.

Parameter	Symbol	Min.	Typ.	Max.	Units	Conditions
Switching Time (Switching times guaranteed by design)						
Rise Time	t_R	—	23	35	ns	Figure 1-1, $C_L = 1800$ pF
		—	28	60		
Fall time	t_F	—	25	35	ns	Figure 1-1, $C_L = 1800$ pF
		—	32	60		
Delay Time	t_{D1}	—	33	75	ns	Figure 1-1, $C_L = 1800$ pF
		—	32	100		
	t_{D2}	—	38	75	ns	Figure 1-1, $C_L = 1800$ pF
		—	38	100		
Pulse Width	t_{PW}	400	—	—	ns	Figure 1-1
Power Supply						
Power Supply Current	I_S	—	—	2.5	mA	$V_{IN} = 3.0V$ (both inputs)
		—	—	3.5		
		—	—	0.25	mA	$V_{IN} = 0.0V$ (both inputs)
		—	—	0.3		

TEMPERATURE SPECIFICATIONS (Note 1)

Parameters	Sym.	Min.	Typ.	Max.	Units	Conditions
Temperature Ranges						
Storage Temperature Range	T_S	-65	—	+150	°C	—
Lead Temperature	T_A	—	—	+300	°C	—
Package Thermal Resistances						
Thermal Resistance DIP	θ_{JA}	—	130	—	°C/W	—
Thermal Resistance DIP	θ_{JC}	—	42	—		—
Thermal Resistance Wide-SOIC	θ_{JA}	—	120	—		—
Thermal Resistance Wide-SOIC	θ_{JC}	—	75	—		—
Thermal Resistance SOIC	θ_{JA}	—	120	—		—
Thermal Resistance SOIC	θ_{JC}	—	75	—		—

Note 1: The maximum allowable power dissipation is a function of ambient temperature, the maximum allowable junction temperature and the thermal resistance from junction to air (i.e., T_A , T_J , θ_{JA}).

Test Circuit

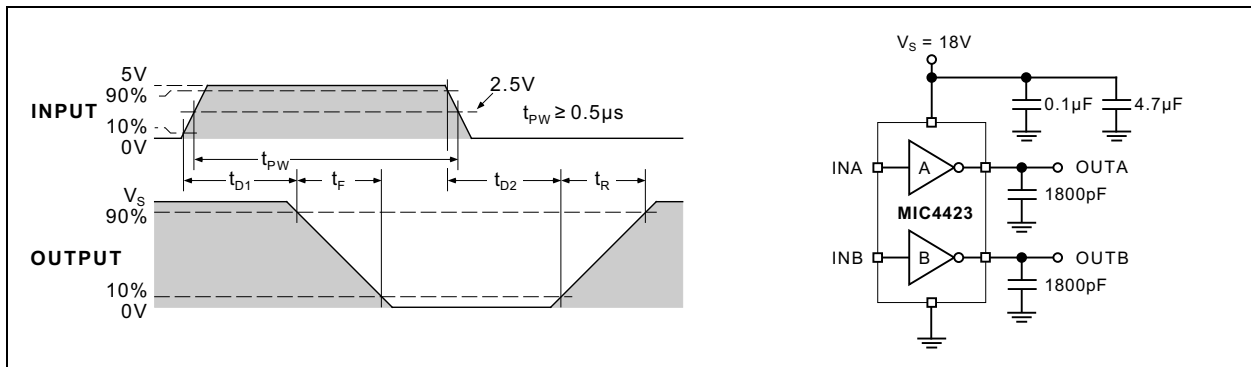

FIGURE 1-1: Inverting Driver Switching Time.

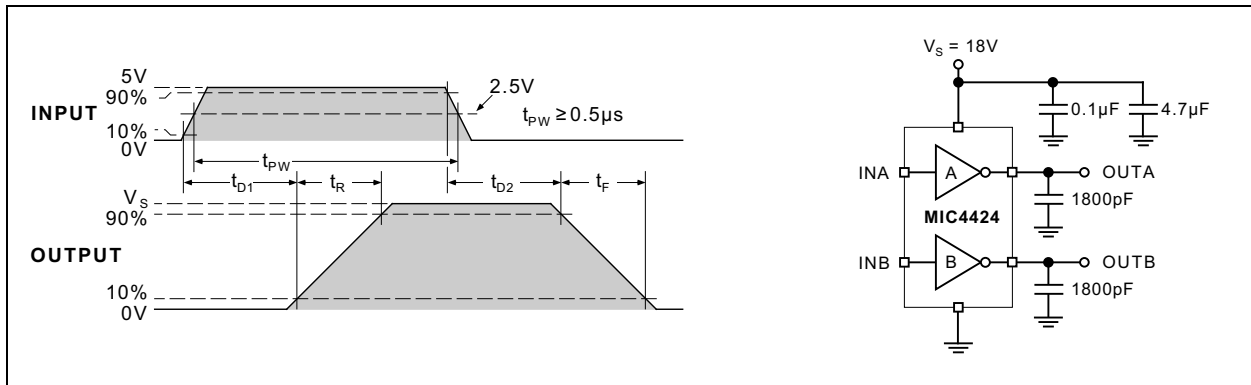

FIGURE 1-2: Non-Inverting Driver Switching Time.

MIC4423/4/5

2.0 TYPICAL PERFORMANCE CURVES

Note: The graphs and tables provided following this note are a statistical summary based on a limited number of samples and are provided for informational purposes only. The performance characteristics listed herein are not tested or guaranteed. In some graphs or tables, the data presented may be outside the specified operating range (e.g., outside specified power supply range) and therefore outside the warranted range.

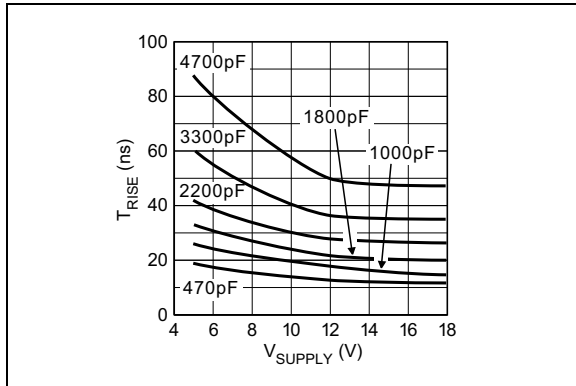

FIGURE 2-1: Rise Time vs. Supply Voltage.

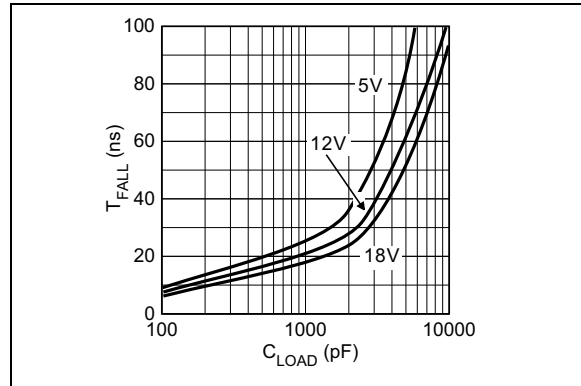

FIGURE 2-4: Fall Time vs. Capacitive Load.

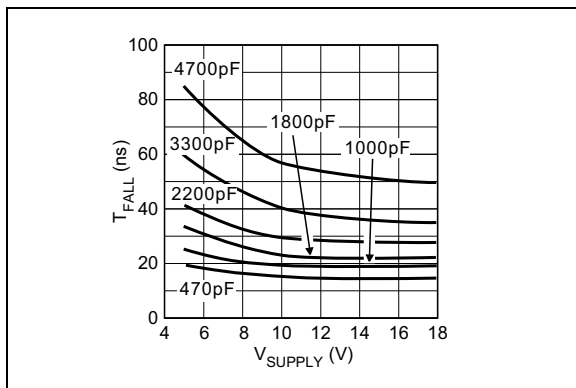

FIGURE 2-2: Fall Time vs. Supply Voltage.

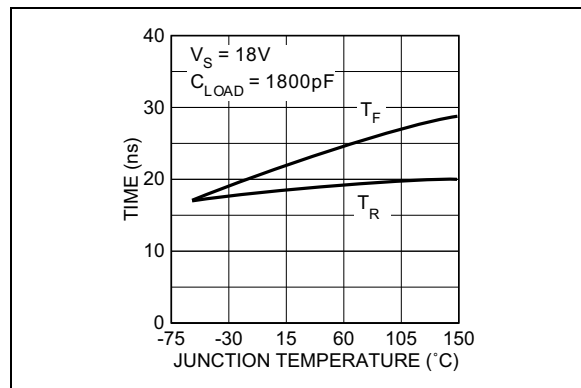

FIGURE 2-5: Rise and Fall Time vs. Temperature.

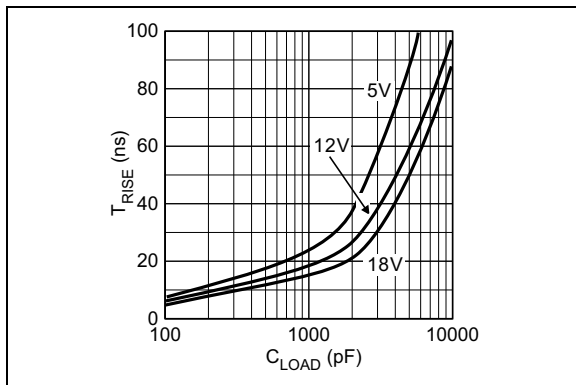

FIGURE 2-3: Rise Time vs. Capacitive Load.

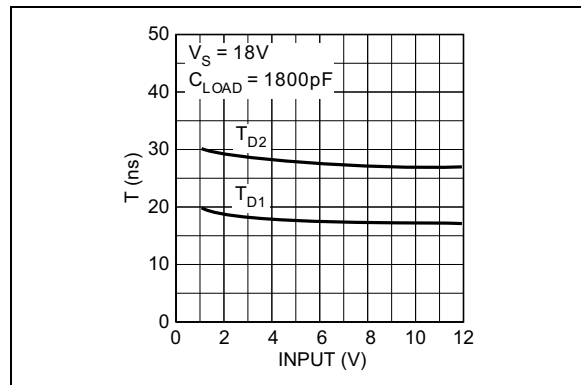

FIGURE 2-6: Propagation Delay vs. Input Amplitude.

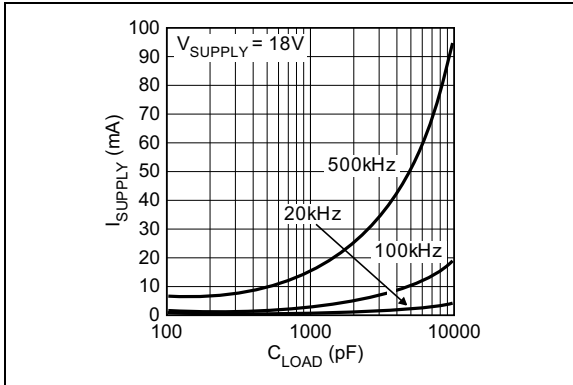

FIGURE 2-7: Supply Current vs. Capacitive Load.

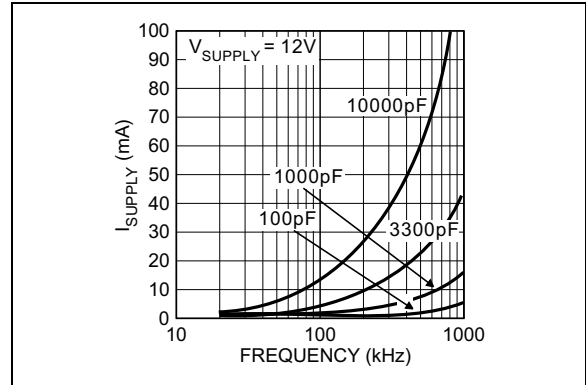

FIGURE 2-10: Supply Current vs. Frequency.

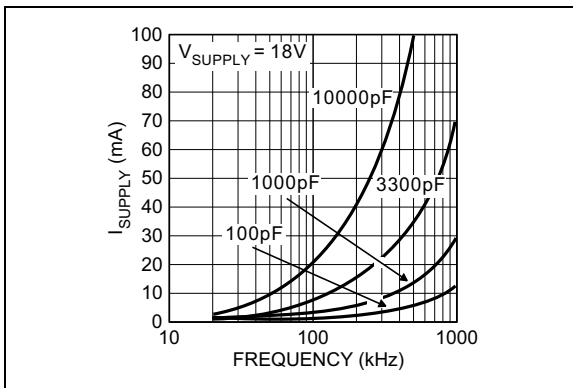

FIGURE 2-8: Supply Current vs. Frequency.

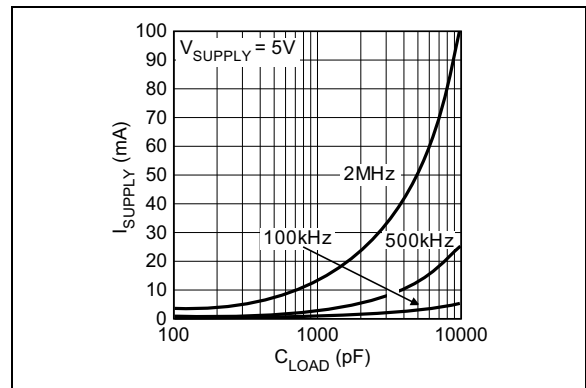

FIGURE 2-11: Supply Current vs. Capacitive Load.

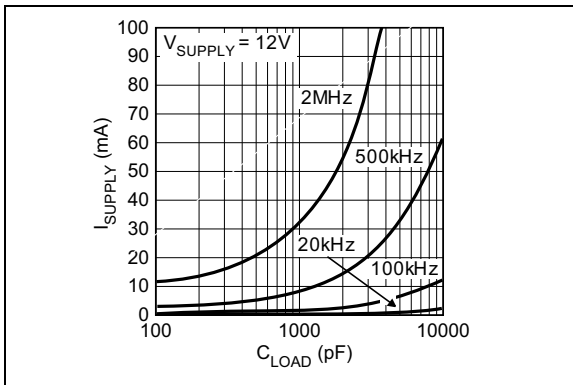

FIGURE 2-9: Supply Current vs. Capacitive Load.

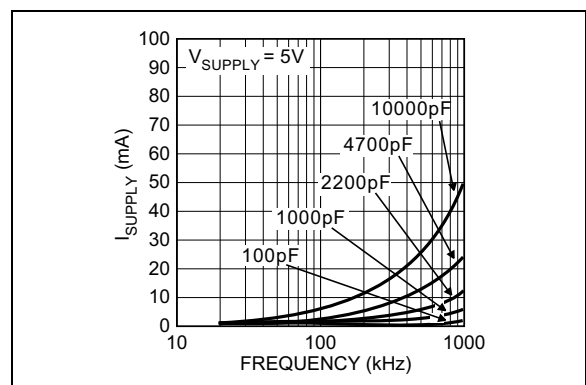

FIGURE 2-12: Supply Current vs. Frequency.

MIC4423/4/5

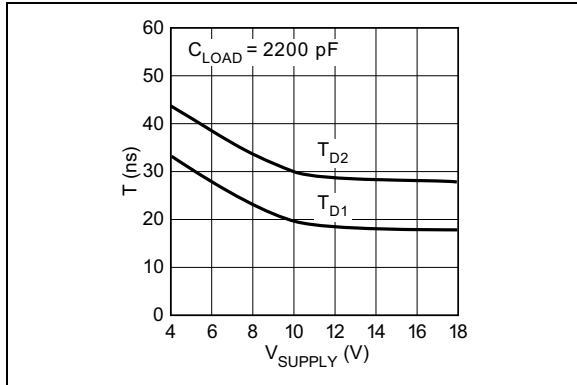

FIGURE 2-13: Delay Time vs. Supply Voltage.

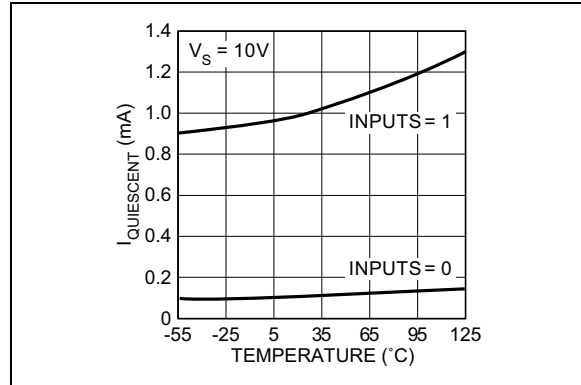

FIGURE 2-16: Quiescent Current vs. Temperature.

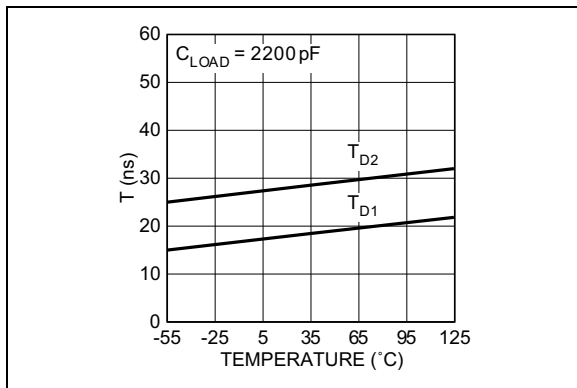

FIGURE 2-14: Delay Time vs. Temperature.

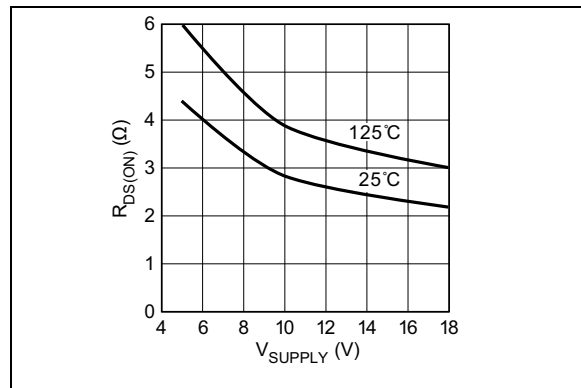

FIGURE 2-17: Output Resistance (Output High) vs. Supply Voltage.

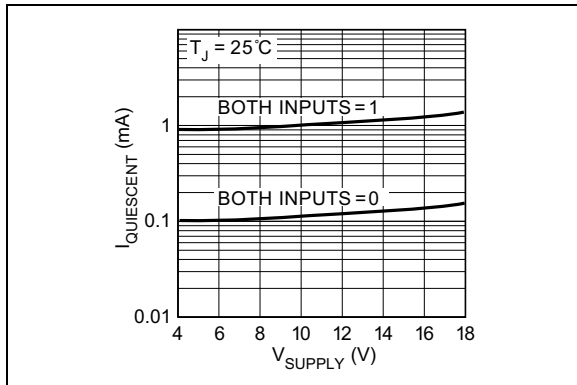

FIGURE 2-15: Quiescent Supply Current vs. Voltage.

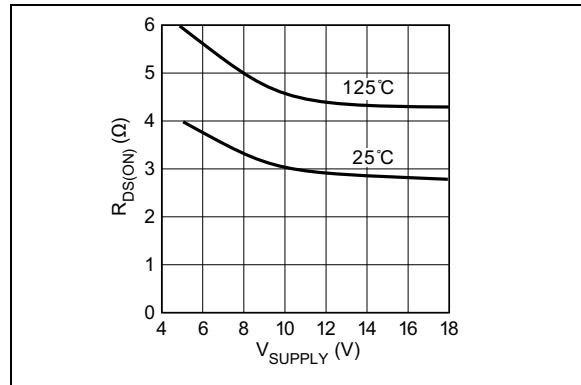

FIGURE 2-18: Output Resistance (Output Low) vs. Supply Voltage.

3.0 PIN DESCRIPTIONS

The descriptions of the pins are listed in [Table 3-1](#).

TABLE 3-1: PIN FUNCTION TABLE

Pin Number DIP, SOIC	Pin Number Wide SOIC	Pin Name	Description
2, 4	2, 7	INA/B	Control Input.
3	4, 5	GND	Ground: Duplicate pins must be externally connected together.
6	12, 13	VS	Supply Input: Duplicate pins must be externally connected together.
7, 5	14, 15, 10, 11	OUTA/B	Output: Duplicate pins must be externally connected together.
1, 8	1, 3, 6, 8, 9, 16	NC	Not connected.

Device Configuration

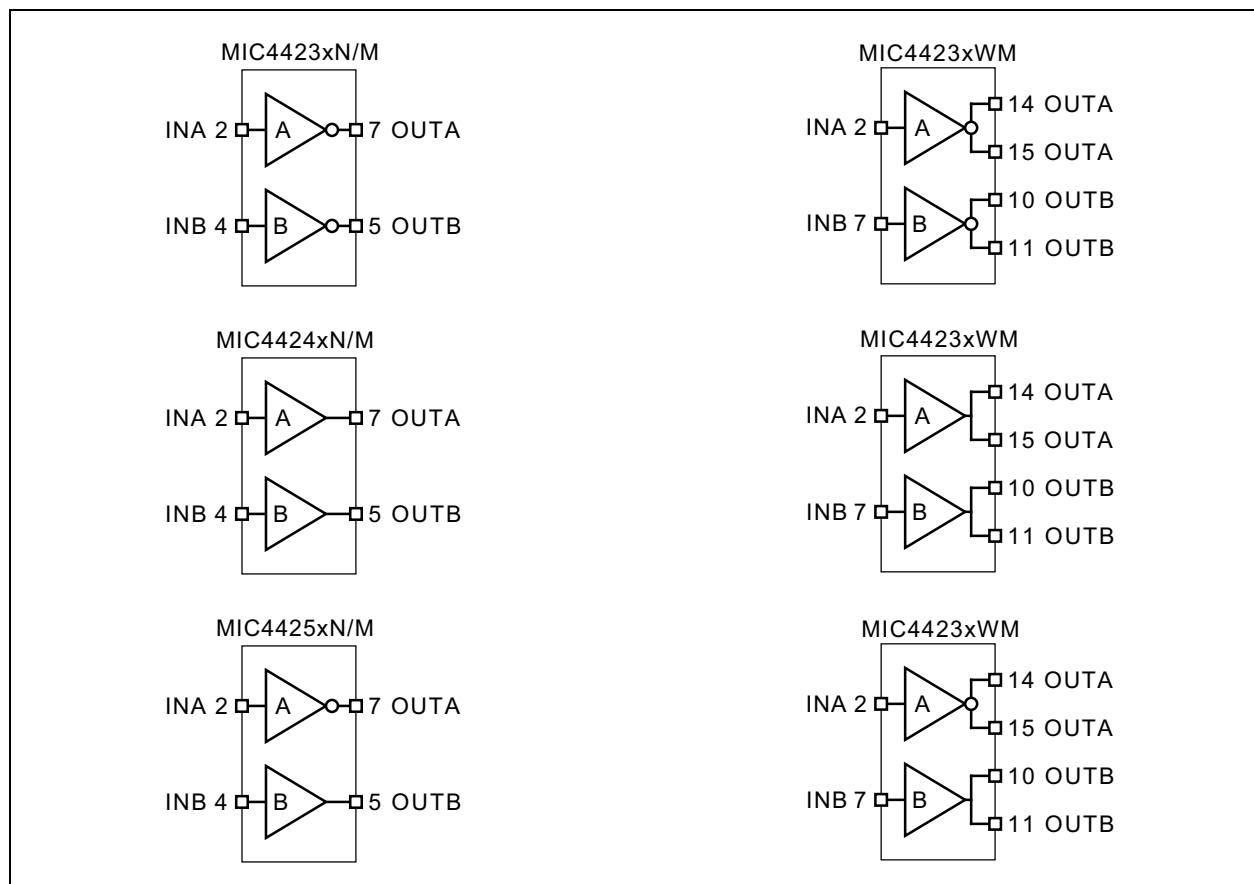

4.0 APPLICATION INFORMATION

Although the MIC4423/4/5 drivers have been specifically constructed to operate reliably under any practical circumstances. There are, nonetheless, details of usage that will provide better operation of the device.

4.1 Supply Bypassing

Charging and discharging large capacitive loads quickly requires large currents. For example, charging 2000 pF from 0 to 15 volts in 20 ns requires a constant current of 1.5A. In practice, the charging current is not constant, and will usually peak at around 3A. In order to charge the capacitor, the driver must be capable of drawing this much current, this quickly, from the system power supply. In turn, this means that as far as the driver is concerned, the system power supply, as seen by the driver, must have a very low impedance.

As a practical matter, this means that the power supply bus must be capacitively bypassed at the driver with at least 100X the load capacitance in order to achieve optimum driving speed. It also implies that the bypassing capacitor must have very low internal inductance and resistance at all frequencies of interest. Generally, this means using two capacitors, one a high-performance low ESR film, the other a low internal resistance ceramic, as together the valleys in their two impedance curves allow adequate performance over a broad enough band to get the job done. Many film capacitors can be sufficiently inductive as to be useless for this service. Likewise, many multilayer ceramic capacitors have unacceptably high internal resistance. Use capacitors intended for high pulse current service. The high pulse current demands of capacitive drivers also mean that the bypass capacitors must be mounted very close to the driver in order to prevent the effects of lead inductance or PCB land inductance from nullifying what you are trying to accomplish. For optimum results the sum of the lengths of the leads and the lands from the capacitor body to the driver body should total 2.5 cm or less.

Bypass capacitance, and its close mounting to the driver serves two purposes. Not only does it allow optimum performance from the driver, it minimizes the amount of lead length radiating at high frequency during switching, (due to the large ΔI) thus minimizing the amount of EMI later available for system disruption and subsequent cleanup. It should also be noted that the actual frequency of the EMI produced by a driver is not the clock frequency at which it is driven, but is related to the highest rate of change of current produced during switching, a frequency generally one or two orders of magnitude higher, and thus more difficult to filter if you let it permeate your system. **Good bypassing practice is essential for proper operation of high speed driver ICs.**

4.2 Grounding

Both proper bypassing and proper grounding are necessary for optimum driver operation. Bypassing capacitance only allows a driver to turn the load ON. Eventually (except in rare circumstances) it is also necessary to turn the load OFF. This requires attention to the ground path. Two things other than the driver affect the rate at which it is possible to turn a load off: The adequacy of the grounding available for the driver, and the inductance of the leads from the driver to the load. The latter will be discussed in a separate section.

Best practice for a ground path is obviously a well laid out ground plane. However, this is not always practical, and a poorly-laid out ground plane can be worse than none. Attention to the paths taken by return currents even in a ground plane is essential. In general, the leads from the driver to its load, the driver to the power supply, and the driver to whatever is driving it should all be as low in resistance and inductance as possible. Of the three paths, the ground lead from the driver to the logic driving it is most sensitive to resistance or inductance, and ground current from the load are what is most likely to cause disruption. Thus, these ground paths should be arranged so that they never share a land, or do so for as short a distance as is practical.

To illustrate what can happen, consider the following: The inductance of a 2 cm long land, 1.59 mm (0.062") wide on a PCB with no ground plane is approximately 45 nH. Assuming a dI/dt of 0.3 A/ns (which will allow a current of 3A to flow after 10 ns, and is thus slightly slow for our purposes) a voltage of 13.5 volts will develop along this land in response to our postulated ΔI . For a 1 cm land, (approximately 15 nH) 4.5 volts is developed. Either way, anyone using TTL level input signals to the driver will find that the response of their driver has been seriously degraded by a common ground path for input to and output from the driver of the given dimensions. Note that this is before accounting for any resistive drops in the circuit. The resistive drop in a 1.59 mm (0.062") land of 2 oz. Copper carrying 3A will be about 4 mV/cm (10 mV/in) at DC, and the resistance will increase with frequency as skin effect comes into play.

The problem is most obvious in inverting drivers where the input and output currents are in phase so that any attempt to raise the driver's input voltage (in order to turn the driver's load off) is countered by the voltage developed on the common ground path as the driver attempts to do what it was supposed to. It takes very little common ground path, under these circumstances, to alter circuit operation drastically.

4.3 Output Lead Inductance

The same descriptions just given for PCB land inductance apply equally well for the output leads from a driver to its load, except that commonly the load is located much further away from the driver than the driver's ground bus.

Generally, the best way to treat the output lead inductance problem, when distances greater than 4 cm (2") are involved, requires treating the output leads as a transmission line. Unfortunately, as both the output impedance of the driver and the input impedance of the MOSFET gate are at least an order of magnitude lower than the impedance of common coax, using coax is seldom a cost-effective solution. A twisted pair works about as well, is generally lower in cost, and allows use of a wider variety of connectors. The second wire of the twisted pair should carry common from as close as possible to the ground pin of the driver directly to the ground terminal of the load. Do not use a twisted pair where the second wire in the pair is the output of the other driver, as this will not provide a complete current path for either driver. Likewise, do not use a twisted triad with two outputs and a common return unless both of the loads to be driver are mounted extremely close to each other, and you can guarantee that they will never be switching at the same time.

For output leads on a printed circuit, the general rule is to make them as short and as wide as possible. The lands should also be treated as transmission lines: i.e. minimize sharp bends, or narrowings in the land, as these will cause ringing. For a rough estimate, on a 1.59 mm (0.062") thick G-10 PCB a pair of opposing lands each 2.36 mm (0.093") wide translates to a characteristic impedance of about 50Ω. Half that width suffices on a 0.787 mm (0.031") thick board. For accurate impedance matching with a MIC4423/24/25 driver, on a 1.59 mm (0.062") board a land width of 42.75 mm (1.683") would be required, due to the low impedance of the driver and (usually) its load. This is obviously impractical under most circumstances. Generally the trade-off point between lands and wires comes when lands narrower than 3.18 mm (0.125") would be required on a 1.59 mm (0.062") board.

To obtain minimum delay between the driver and the load, it is considered best to locate the driver as close as possible to the load (using adequate bypassing). Using matching transformers at both ends of a piece of coax, or several matched lengths of coax between the driver and the load, works in theory, but is not optimum.

4.4 Driving at Controlled Rates

Occasionally there are situations where a controlled rise or fall time (which may be considerably longer than the normal rise or fall time of the driver's output) is desired for a load. In such cases it is still prudent to employ best possible practice in terms of bypassing, grounding and PCB layout, and then reduce the

switching speed of the load (not the driver) by adding a non-inductive series resistor of appropriate value between the output of the driver and the load. For situations where only rise or only fall should be slowed, the resistor can be paralleled with a fast diode so that switching in the other direction remains fast. Due to the Schmitt trigger action of the driver's input it is not possible to slow the rate of rise (or fall) of the driver's input signal to achieve slowing of the output.

4.5 Input Stage

The input stage of the MIC4423/24/25 consists of a single-MOSFET class A stage with an input capacitance of ≤ 38 pF.

This capacitance represents the maximum load from the driver that will be seen by its controlling logic. The drain load on the input MOSFET is a -2 mA current source. Thus, the quiescent current drawn by the driver varies, depending on the logic state of the input.

Following the input stage is a buffer stage which provides ~ 400 mV of hysteresis for the input, to prevent oscillations when slowly-changing input signals are used or when noise is present on the input. Input voltage switching threshold is approximately 1.5V which makes the driver directly compatible with TTL signals, or with CMOS powered from any supply voltage between 3V and 15V.

The MIC4423/24/25 drivers can also be driven directly by the SG1524/25/26/27, TL494/95, TL594/95, NE5560/61/62/68, TSC170, MIC38C42, and similar switch mode power supply ICs. By relocating the main switch drive function into the driver rather than using the somewhat limited drive capabilities of a PWM IC. The PWM IC runs cooler, which generally improves its performance and longevity, and the main switches switch faster, which reduces switching losses and increase system efficiency.

The input protection circuitry of the MIC4423/24/25, in addition to providing 2 kV or more of ESD protection, also works to prevent latch-up or logic upset due to ringing or voltage spiking on the logic input terminal. In most CMOS devices when the logic input rises above the power supply terminal, or descends below the ground terminal, the device can be destroyed or rendered inoperable until the power supply is cycled OFF and ON. The MIC4423/24/25 drivers have been designed to prevent this. Input voltages excursions as great as 5V below ground will not alter the operation of the device. Input excursions above the power supply voltage will result in the excess voltage being conducted to the power supply terminal of the IC. Because the excess voltage is simply conducted to the power terminal, if the input to the driver is left in a high state when the power supply to the driver is turned off, currents as high as 30 mA can be conducted through the driver from the input terminal to its power supply terminal. This may overload the output of whatever is

driving the driver, and may cause other devices that share the driver's power supply, as well as the driver, to operate when they are assumed to be off, but it will not harm the driver itself. Excessive input voltage will also slow the driver down, and result in much longer internal propagation delays within the drivers. T_{D2} , for example, may increase to several hundred nanoseconds. In general, while the driver will accept this sort of misuse without damage, proper termination of the line feeding the driver so that line spiking and ringing are minimized, will always result in faster and more reliable operation of the device, leave less EMI to be filtered elsewhere, be less stressful to other components in the circuit, and leave less chance of unintended modes of operation.

4.6 Power Dissipation

CMOS circuits usually permit the user to ignore power dissipation. Logic families such as 4000 series and 74Cxxx have outputs which can only source or sink a few milliamps of current, and even shorting the output of the device to ground or V_{CC} may not damage the device. CMOS drivers, on the other hand, are intended to source or sink several Amps of current. This is necessary in order to drive large capacitive loads at frequencies into the megahertz range. Package power dissipation of driver ICs can easily be exceeded when driving large loads at high frequencies. Care must therefore be paid to device dissipation when operating in this domain.

The Supply Current vs Frequency and Supply Current vs Load in the [Section 2.0 "Typical Performance Curves"](#) furnished with this data sheet aid in estimating power dissipation in the driver. Operating frequency, power supply voltage, and load all affect power dissipation.

Given the power dissipation in the device, and the thermal resistance of the package, junction operating temperature for any ambient is easy to calculate. For example, the thermal resistance of the 8-pin plastic DIP package, from the data sheet, is 150°C/W. In a 25°C ambient, then, using a maximum junction temperature of 150°C, this package will dissipate 960 mW.

Accurate power dissipation numbers can be obtained by summing the three sources of power dissipation in the device:

- Load power dissipation (P_L)
- Quiescent power dissipation (P_Q)
- Transition power dissipation (P_T)

Calculation of load power dissipation differs depending on whether the load is capacitive, resistive or inductive.

4.7 Resistive Load Power Dissipation

Dissipation caused by a resistive load can be calculated in the following [Equation 4-1](#):

EQUATION 4-1:

$$P_L = I^2 \times R \times D_O$$

Where:

- I = The current drawn by the load
- R_O = The output resistance of the driver when the output is high, at the power supply voltage used (See [Section 2.0 "Typical Performance Curves"](#))
- D = Fraction of time the load is conducting (duty cycle)

4.8 Capacitive Load Power Dissipation

Dissipation caused by a capacitive load is simply the energy placed in, or removed from, the load capacitance by the driver. The energy stored in a capacitor is described in the following [Equation 4-2](#):

EQUATION 4-2:

$$E = 1/2 \times C \times V^2$$

As this energy is lost in the driver each time the load is charged or discharged, for power dissipation calculations the 1/2 is removed. This equation also shows that it is good practice not to place more voltage in the capacitor than is necessary, as dissipation increases as the square of the voltage applied to the capacitor. For a driver with a capacitive load.

EQUATION 4-3:

$$P_L = f \times C (V_S)^2$$

Where:

- f = Operating frequency
- C = Load capacitance
- V_S = Driver supply voltage

4.9 Inductive Load Power Dissipation

For inductive loads the situation is more complicated. For the part of the cycle in which the driver is actively forcing current into the inductor, the situation is the same as it is in the resistive case:

EQUATION 4-4:

$$P_{L1} = I^2 \times R \times D_O$$

However, in this instance the R_O required may be either the on resistance of the driver when its output is in the high state, or its on resistance when the driver is in the low state, depending on how the inductor is connected, and this is still only half the story. For the part of the cycle when the inductor is forcing current through the driver, dissipation is best described as:

EQUATION 4-5:

$$P_{L2} = I \times V_D(1 - D)$$

Where:

V_D = The forward drop of the clamp diode in the driver (generally around 0.7V).

The two parts of the load dissipation must be summed in to produce P_L .

EQUATION 4-6:

$$P_L = P_{L1} + P_{L2}$$

4.10 Quiescent Power Dissipation

Quiescent power dissipation (P_Q , as described in the input section) depends on whether the input is high or low. A low input will result in a maximum current drain (per driver) of ≤ 0.2 mA; a logic high will result in a current drain of ≤ 2.0 mA. Quiescent power can therefore be found from:

EQUATION 4-7:

$$P_Q = V_S[D \times I_H + (1 - D) \times I_L]$$

Where:

I_H = Quiescent current with input high
 I_L = Quiescent current with input low
 D = Fraction of time input is high (duty cycle)
 V_S = Power supply voltage

4.11 Transition Power Dissipation

Transition power is dissipated in the driver each time its output changes state, because during the transition, for a very brief interval, both the N-Channel and P-Channel MOSFETs in the output totem-pole are ON simultaneously, and a current is conducted through them from V_S to ground. The transition power dissipation is approximately:

EQUATION 4-8:

$$P_T = f \times V_S(A \times s)$$

Where:

($A \times s$) = is a time current factor derived from [Figure 4-1](#)

Total power (P_D) then, is described as:

EQUATION 4-9:

$$P_D = P_L + P_Q + P_T$$

Examples show the relative magnitude for each term.

MIC4423/4/5

EXAMPLE 1: The MIC4423 operating on a 12V supply driving two capacitive loads of 3000 pF each, operating at 250 kHz, with a duty cycle of 50%, in a maximum ambient of 60°C.

First, calculate load power loss:

$$P_L = f \times C \times (V_S)^2$$
$$P_L = 250,000 \times (3 \times 10^9 + 3 \times 10^9) \times 12^2 = 0.2160 W$$

Then, transition power loss:

$$P_T = f \times V_S \times (A \times s)$$
$$= 250,000 \times 12 \times 2.2 \times 10 = 6.6 mW$$

Then quiescent power loss:

$$P_Q = V_S [D \times I_H + (1 - D) \times I_L]$$
$$= 12 \times [(0.5 \times 0.0035) + (0.5 \times 0.0003)]$$
$$= 0.0228 W$$

Total power dissipation, then, is:

$$P_D = 0.2160 + 0.0066 + 0.0228 = 0.2454 W$$

Assuming an SOIC package, with θ_{JA} of 120°C/W, this will result in the junction running at 29.4°C above ambient.

$$0.2454 \times 120 = 29.4^\circ C$$

Given a maximum ambient temperature of 60°C, this will result in a maximum junction temperature of 89.4°C.

EXAMPLE 2: A MIC4424 operating on a 15V input, with one driver driving a 50Ω resistive load at 1 MHz, with a duty cycle of 67%, and the other driver quiescent, in a maximum ambient temperature of 40°C:

$$P_L = I^2 \times R_O \times D$$

First, I_O must be determined.

EQUATION 4-10:

$$I_O = V_S / (R_O + R_{LOAD})$$

Given R_O from the characteristic curves then:

$$I_O = 15 / (3.3 + 50)$$
$$I_O = 0.281 A$$

and:

$$P_L = (0.281)^2 \times 3.3 \times 0.67 = 0.174 W$$
$$P_T = F \times V_S \times (A \times s) / 2$$

because only one side is operating,

$$= (1,000,000 \times 15 \times 3.3 \times 10^{-9}) / 2 = 0.025 W$$

and

$$P_Q = 15 \times [(0.67 \times 0.00125) + (0.33 \times 0.000125) + (1 \times 0.000125)]$$

this assumes that the unused side of the driver has its input grounded, which is more efficient = 0.015W.

Then,

$$P_D = 0.174 + 0.025 + 0.0150 = 0.213 W$$

In a ceramic package with an θ_{JA} of 100°C/W, this amount of power results in a junction temperature given the maximum 40°C ambient of:

$$(0.213 \times 100) + 40 = 61.4^\circ C$$

The actual junction temperature will be lower than calculated both because duty cycle is less than 100% and because the graph lists $R_{DS(ON)}$ at a T_J of 125°C and the $R_{DS(ON)}$ at 61°C T_J will be somewhat lower.

4.12 Definitions

C_L = Load Capacitance in Farads.

D = Duty Cycle expressed as the fraction of time the input to the driver is high.

f = Operating Frequency of the driver in Hertz.

I_H = Power supply current drawn by a driver when both inputs are high and neither output is loaded.

I_L = Power supply current drawn by a driver when both inputs are low and neither output is loaded.

I_D = Output current from a driver in Amps.

P_D = Total power dissipated in a driver in Watts.

P_L = Power dissipated in the driver due to the driver's load in Watts.

P_Q = Power dissipated in a quiescent driver in Watts.

P_T = Power dissipated in a driver when the output changes states ("shoot-through current") in Watts.
 NOTE: The "shoot-through" current from a dual transition (once up, once down) for both drivers is stated in the graph on the following page in ampere-nanoseconds. This figure must be multiplied by the number of repetitions per second (frequency to find Watts).

R_O = Output resistance of a driver in Ohms.

V_S = Power supply voltage to the IC in Volts.

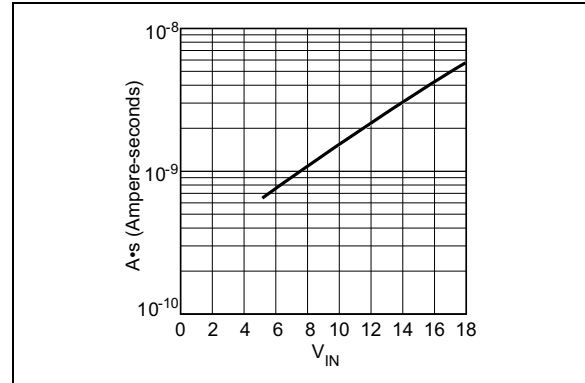

FIGURE 4-1: Crossover Energy Loss.

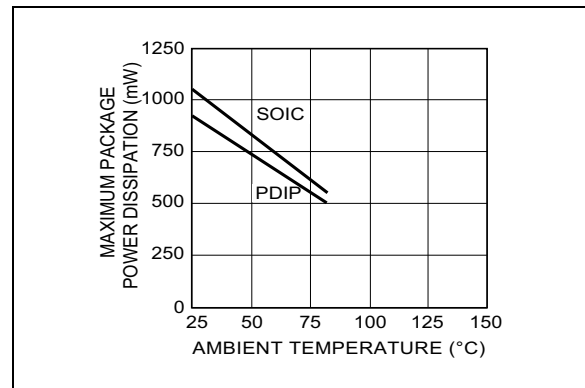

FIGURE 4-2: Power Dissipation vs. Ambient Temperature.

MIC4423/4/5

5.0 PACKAGING INFORMATION

5.1 Package Marking Information

8-Lead PDIP*	Example
8-Lead SOIC*	Example
16-Lead Wide SOIC*	Example

Legend:	XX...X	Product code or customer-specific information
	Y	Year code (last digit of calendar year)
	YY	Year code (last 2 digits of calendar year)
	WW	Week code (week of January 1 is week '01')
	NNN	Alphanumeric traceability code
	(e3)	Pb-free JEDEC® designator for Matte Tin (Sn)
	*	This package is Pb-free. The Pb-free JEDEC designator ((e3)) can be found on the outer packaging for this package.
	•, ▲, ▼	Pin one index is identified by a dot, delta up, or delta down (triangle mark).
Note:	In the event the full Microchip part number cannot be marked on one line, it will be carried over to the next line, thus limiting the number of available characters for customer-specific information. Package may or may not include the corporate logo.	
	Underbar (¯) and/or Overbar (˘) symbol may not be to scale.	

8-Lead SOIC Package Outline and Recommended Land Pattern

TITLE

8 LEAD SOICN PACKAGE OUTLINE & RECOMMENDED LAND PATTERN

DRAWING #	SOICN-8LD-PL-1	UNIT	INCH [MM]
-----------	----------------	------	-----------

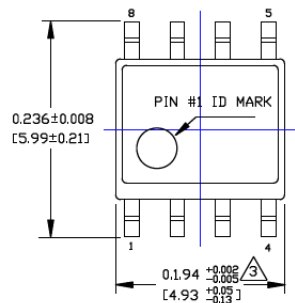

TOP VIEW

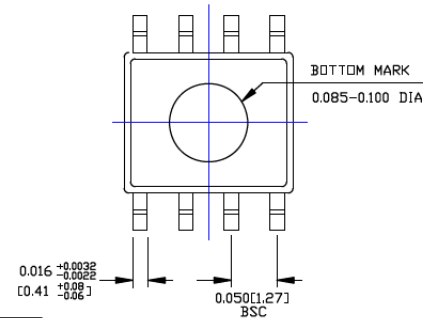

BOTTOM VIEW

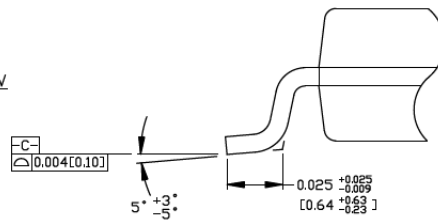

DETAIL "A"

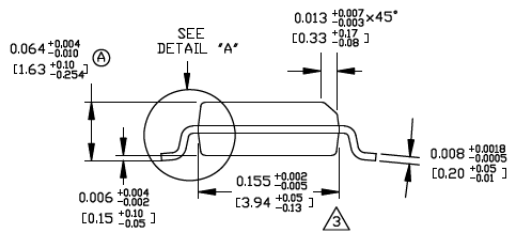

END VIEW

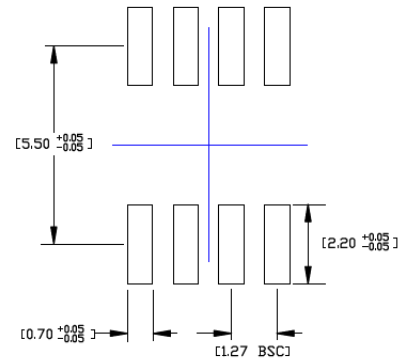

RECOMMENDED LAND PATTERN

NOTES:

1. DIMENSIONS ARE IN INCHES[MM].
2. CONTROLLING DIMENSION: INCHES.
3. DIMENSION DOES NOT INCLUDE MOLD FLASH OR PROTRUSIONS, EITHER OF WHICH SHALL NOT EXCEED 0.010[0.25] PER SIDE.

Note: For the most current package drawings, please see the Microchip Packaging Specification located at <http://www.microchip.com/packaging>.

MIC4423/4/5

8-Lead PDIP Package Outline and Recommended Land Pattern

TITLE

8 LEAD PDIP PACKAGE OUTLINE & RECOMMENDED LAND PATTERN

DRAWING #	PDIP-8LD-PL-1	UNIT	INCH
Lead Frame	Copper	Lead Finish	Matte Tin

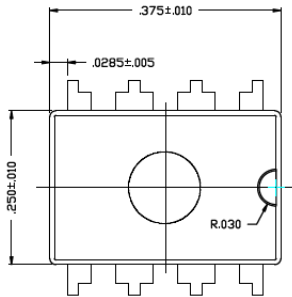

TOP VIEW

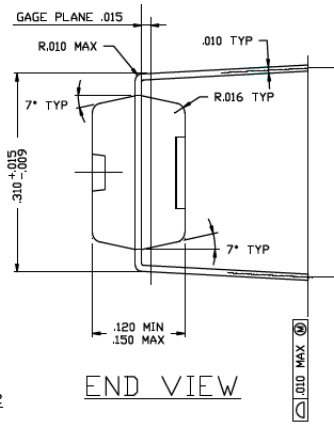

END VIEW

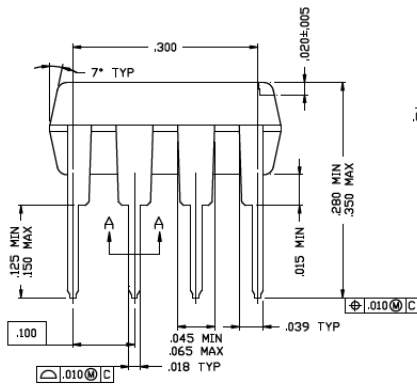

SIDE VIEW

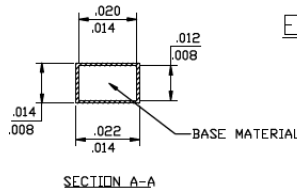

SECTION A-A

Note: For the most current package drawings, please see the Microchip Packaging Specification located at <http://www.microchip.com/packaging>.

16-Lead Wide SOIC Package Outline and Recommended Land Pattern

TITLE

16 LEAD SOICW PACKAGE OUTLINE & RECOMMENDED LAND PATTERN

DRAWING #	SOICW-16LD-PL-1	UNIT	INCH [MM]
-----------	-----------------	------	-----------

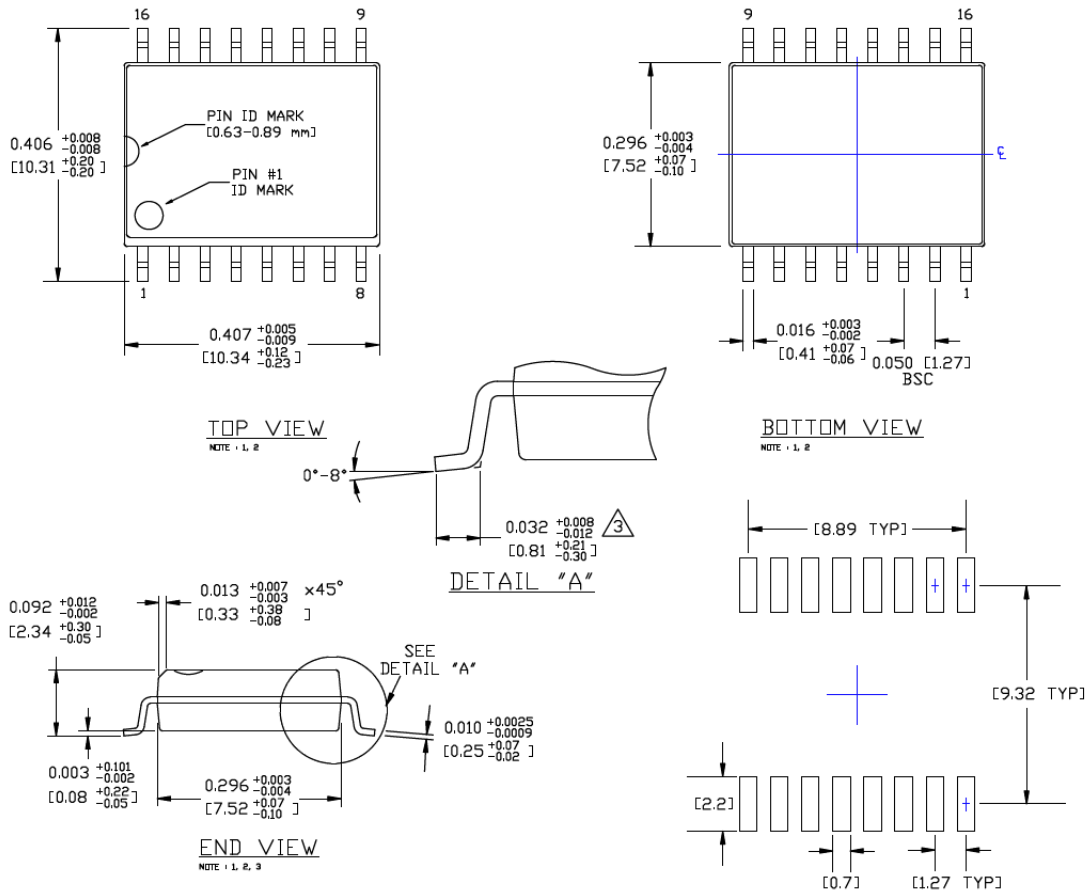

NOTES:

1. DIMENSIONS ARE IN INCHES[MM].
2. CONTROLLING DIMENSION: INCHES.
3. DIMENSION DOES NOT INCLUDE MOLD FLASH OR PROTRUSIONS, EITHER OF WHICH SHALL NOT EXCEED 0.006[0.15] PER SIDE.

Note: For the most current package drawings, please see the Microchip Packaging Specification located at <http://www.microchip.com/packaging>.

MIC4423/4/5

NOTES:

APPENDIX A: REVISION HISTORY

Revision A (May 2022)

- Converted Micrel document MIC4423/4/5 to Microchip data sheet DS20006638A.
- Minor text changes throughout.

MIC4423/4/5

NOTES:

PRODUCT IDENTIFICATION SYSTEM

To order or obtain information, e.g., on pricing or delivery, contact your local Microchip representative or sales office.

<u>PART NO.</u>	<u>X</u>	<u>XX</u>	<u>-XX</u>	Examples:
Device	Junction Temperature Range	Package	Media Type	
Device:	MIC4423:	Dual 3A Peak Low-Side MOSFET Driver Bi-Polar/CMOS/DMOS Process, Dual Inverting		MIC4423-YM 8-Lead SOIC Package, 95/Tube
	MIC4424:	Dual 3A Peak Low-Side MOSFET Driver Bi-Polar/CMOS/DMOS Process, Dual Non-Inverting		MIC4423-YM-TR 8-Lead SOIC Package, 2500/Reel
	MIC4425:	Dual 3A Peak Low-Side MOSFET Driver Bi-Polar/CMOS/DMOS Process, Inverting plus Non-Inverting		MIC4423-YN 8-Lead PDIP Package, 50/Tube
				MIC4423-YWM 16-Lead SOIC Wide Package, 47/Tube
				MIC4423-YWM-TR 16-Lead SOIC Wide Package, 1000/Reel
Junction Temperature Range:	Y =	-40°C to +85°C (RoHS Compliant)		a) MIC4423:
	Z =	0°C to +70°C (RoHS Compliant)		3A Peak, Dual Inverting High Speed, Low-Side MOSFET Driver, Industrial Grade, -40°C to +85°C Temperature Range, RoHS Compliant
Package:	N =	8-Lead PDIP		MIC4423-ZN 8-Lead PDIP Package, 50/Tube
	M =	8-Lead SOIC		MIC4423-ZWM 16-Lead SOIC Wide Package, 47/Tube
	WM =	16-Lead SOIC (Wide Body)		MIC4423-ZWM-TR 16-Lead SOIC Wide Package, 1000/Reel
Media Type:	blank =	95/Tube (M, SOIC)		c) MIC4424:
	blank =	50/Tube (N, PDIP)		3A Peak, Dual Non-Inverting High Speed, Low-Side MOSFET Driver, Industrial Grade, -40°C to +85°C Temperature Range, RoHS Compliant
	blank =	47/Tube (WM, SOIC)		MIC4424-YM 8-Lead SOIC Package, 95/Tube
	TR =	2,500/Reel (M, SOIC)		MIC4424-YM-TR 8-Lead SOIC Package, 2500/Reel
	TR =	1,000/Reel (WM, SOIC)		MIC4424-YN 8-Lead PDIP Package, 50/Tube
				MIC4424-YWM 16-Lead SOIC Wide Package, 47/Tube
				MIC4424-YWM-TR 16-Lead SOIC Wide Package, 1000/Reel
Note 1:	Tape and Reel identifier only appears in the catalog part number description. This identifier is used for ordering purposes and is not printed on the device package. Check with your Microchip Sales Office for package availability with the Tape and Reel option.			d) MIC4424:
				3A Peak, Dual Non-Inverting High Speed, Low-Side MOSFET Driver, Commercial Grade, 0°C to +70°C Temperature Range, RoHS Compliant
				MIC4424-ZN 8-Lead PDIP Package, 50/Tube
				MIC4424-ZWM 16-Lead SOIC Wide Package, 47/Tube
				MIC4424-ZWM-TR 16-Lead SOIC Wide Package, 1000/Reel
				e) MIC4425:
				3A-Peak, Dual Inverting Plus Non-Inverting Hi-Speed, Low-Side MOSFET Driver, Industrial Grade, -40°C to +85°C Temperature Range, RoHS Compliant
				MIC4425-YM 8-Lead SOIC Package, 95/Tube
				MIC4425-YM-TR 8-Lead SOIC Package, 2500/Reel
				MIC4425-YN 8-Lead PDIP Package, 50/Tube
				MIC4425-YWM 16-Lead SOIC Wide Package, 47/Tube
				MIC4425-YWM-TR 16-Lead SOIC Wide Package, 1000/Reel
				f) MIC4425:
				3A-Peak, Dual Inverting Plus Non-Inverting Hi-Speed, Low-Side MOSFET Driver, Commercial Grade, -40°C to +85°C Temperature Range, RoHS Compliant
				MIC4425-ZWM 16-Lead SOIC Wide Package, 47/Tube
				MIC4425-ZWM-TR 16-Lead SOIC Wide Package, 1000/Reel

MIC4423/4/5

NOTES:

Note the following details of the code protection feature on Microchip products:

- Microchip products meet the specifications contained in their particular Microchip Data Sheet.
- Microchip believes that its family of products is secure when used in the intended manner, within operating specifications, and under normal conditions.
- Microchip values and aggressively protects its intellectual property rights. Attempts to breach the code protection features of Microchip product is strictly prohibited and may violate the Digital Millennium Copyright Act.
- Neither Microchip nor any other semiconductor manufacturer can guarantee the security of its code. Code protection does not mean that we are guaranteeing the product is “unbreakable”. Code protection is constantly evolving. Microchip is committed to continuously improving the code protection features of our products.

This publication and the information herein may be used only with Microchip products, including to design, test, and integrate Microchip products with your application. Use of this information in any other manner violates these terms. Information regarding device applications is provided only for your convenience and may be superseded by updates. It is your responsibility to ensure that your application meets with your specifications. Contact your local Microchip sales office for additional support or, obtain additional support at <https://www.microchip.com/en-us/support/design-help/client-support-services>.

THIS INFORMATION IS PROVIDED BY MICROCHIP "AS IS". MICROCHIP MAKES NO REPRESENTATIONS OR WARRANTIES OF ANY KIND WHETHER EXPRESS OR IMPLIED, WRITTEN OR ORAL, STATUTORY OR OTHERWISE, RELATED TO THE INFORMATION INCLUDING BUT NOT LIMITED TO ANY IMPLIED WARRANTIES OF NON-INFRINGEMENT, MERCHANTABILITY, AND FITNESS FOR A PARTICULAR PURPOSE, OR WARRANTIES RELATED TO ITS CONDITION, QUALITY, OR PERFORMANCE.

IN NO EVENT WILL MICROCHIP BE LIABLE FOR ANY INDIRECT, SPECIAL, PUNITIVE, INCIDENTAL, OR CONSEQUENTIAL LOSS, DAMAGE, COST, OR EXPENSE OF ANY KIND WHATSOEVER RELATED TO THE INFORMATION OR ITS USE, HOWEVER CAUSED, EVEN IF MICROCHIP HAS BEEN ADVISED OF THE POSSIBILITY OR THE DAMAGES ARE FORESEEABLE. TO THE FULLEST EXTENT ALLOWED BY LAW, MICROCHIP'S TOTAL LIABILITY ON ALL CLAIMS IN ANY WAY RELATED TO THE INFORMATION OR ITS USE WILL NOT EXCEED THE AMOUNT OF FEES, IF ANY, THAT YOU HAVE PAID DIRECTLY TO MICROCHIP FOR THE INFORMATION.

Use of Microchip devices in life support and/or safety applications is entirely at the buyer's risk, and the buyer agrees to defend, indemnify and hold harmless Microchip from any and all damages, claims, suits, or expenses resulting from such use. No licenses are conveyed, implicitly or otherwise, under any Microchip intellectual property rights unless otherwise stated.

For information regarding Microchip's Quality Management Systems, please visit www.microchip.com/quality.

Trademarks

The Microchip name and logo, the Microchip logo, Adaptec, AnyRate, AVR, AVR logo, AVR Freaks, BesTime, BitCloud, CryptoMemory, CryptoRF, dsPIC, flexPWR, HELDO, IGLOO, JukeBlox, KeeLoq, Kleer, LANCheck, LinkMD, maXStylus, maXTouch, MediaLB, megaAVR, Microsemi, Microsemi logo, MOST, MOST logo, MPLAB, OptoLyzer, PIC, picoPower, PICSTART, PIC32 logo, PolarFire, Prochip Designer, QTouch, SAM-BA, SenGenuity, SpyNIC, SST, SST Logo, SuperFlash, Symmetricom, SyncServer, Tachyon, TimeSource, tinyAVR, UNI/O, Vectron, and XMEGA are registered trademarks of Microchip Technology Incorporated in the U.S.A. and other countries.

AgileSwitch, APT, ClockWorks, The Embedded Control Solutions Company, EtherSynch, Flashtec, Hyper Speed Control, HyperLight Load, IntelliMOS, Libero, motorBench, mTouch, Powermite 3, Precision Edge, ProASIC, ProASIC Plus, ProASIC Plus logo, QuietWire, SmartFusion, SyncWorld, Temux, TimeCesium, TimeHub, TimePictra, TimeProvider, TrueTime, WinPath, and ZL are registered trademarks of Microchip Technology Incorporated in the U.S.A.

Adjacent Key Suppression, AKS, Analog-for-the-Digital Age, Any Capacitor, AnyIn, AnyOut, Augmented Switching, BlueSky, BodyCom, CodeGuard, CryptoAuthentication, CryptoAutomotive, CryptoCompanion, CryptoController, dsPICDEM, dsPICDEM.net, Dynamic Average Matching, DAM, ECAN, Espresso T1S, EtherGREEN, GridTime, IdealBridge, In-Circuit Serial Programming, ICSP, INICnet, Intelligent Paralleling, Inter-Chip Connectivity, JitterBlocker, Knob-on-Display, maxCrypto, maxView, memBrain, Mindi, MiWi, MPASM, MPF, MPLAB Certified logo, MPLIB, MPLINK, MultiTRAK, NetDetach, NVM Express, NVMe, Omniscient Code Generation, PICDEM, PICDEM.net, PICkit, PICtail, PowerSmart, PureSilicon, QMatrix, REAL ICE, Ripple Blocker, RTAX, RTG4, SAM-ICE, Serial Quad I/O, simpleMAP, SimpliPHY, SmartBuffer, SmartHLS, SMART-I.S., storClad, SQI, SuperSwitcher, SuperSwitcher II, Switchtec, SynchroPHY, Total Endurance, TSHARC, USBCheck, VariSense, VectorBlox, VeriPHY, ViewSpan, WiperLock, XpressConnect, and ZENA are trademarks of Microchip Technology Incorporated in the U.S.A. and other countries.

SQTP is a service mark of Microchip Technology Incorporated in the U.S.A.

The Adaptec logo, Frequency on Demand, Silicon Storage Technology, Symmcom, and Trusted Time are registered trademarks of Microchip Technology Inc. in other countries.

GestIC is a registered trademark of Microchip Technology Germany II GmbH & Co. KG, a subsidiary of Microchip Technology Inc., in other countries.

All other trademarks mentioned herein are property of their respective companies.

© 2022, Microchip Technology Incorporated and its subsidiaries.

All Rights Reserved.

ISBN: 978-1-6683-0372-6



MICROCHIP

Worldwide Sales and Service

AMERICAS

Corporate Office
2355 West Chandler Blvd.
Chandler, AZ 85224-6199
Tel: 480-792-7200
Fax: 480-792-7277
Technical Support:
<http://www.microchip.com/support>
Web Address:
www.microchip.com

Atlanta

Duluth, GA
Tel: 678-957-9614
Fax: 678-957-1455

Austin, TX

Tel: 512-257-3370

Boston

Westborough, MA
Tel: 774-760-0087
Fax: 774-760-0088

Chicago

Itasca, IL
Tel: 630-285-0071
Fax: 630-285-0075

Dallas

Addison, TX
Tel: 972-818-7423
Fax: 972-818-2924

Detroit

Novi, MI
Tel: 248-848-4000

Houston, TX

Tel: 281-894-5983

Indianapolis

Noblesville, IN
Tel: 317-773-8323
Fax: 317-773-5453
Tel: 317-536-2380

Los Angeles

Mission Viejo, CA
Tel: 949-462-9523
Fax: 949-462-9608
Tel: 951-273-7800

Raleigh, NC

Tel: 919-844-7510

New York, NY

Tel: 631-435-6000

San Jose, CA

Tel: 408-735-9110
Tel: 408-436-4270

Canada - Toronto

Tel: 905-695-1980
Fax: 905-695-2078

ASIA/PACIFIC

Australia - Sydney
Tel: 61-2-9868-6733

China - Beijing
Tel: 86-10-8569-7000

China - Chengdu
Tel: 86-28-8665-5511

China - Chongqing
Tel: 86-23-8980-9588

China - Dongguan
Tel: 86-769-8702-9880

China - Guangzhou
Tel: 86-20-8755-8029

China - Hangzhou
Tel: 86-571-8792-8115

China - Hong Kong SAR
Tel: 852-2943-5100

China - Nanjing
Tel: 86-25-8473-2460

China - Qingdao
Tel: 86-532-8502-7355

China - Shanghai
Tel: 86-21-3326-8000

China - Shenyang
Tel: 86-24-2334-2829

China - Shenzhen
Tel: 86-755-8864-2200

China - Suzhou
Tel: 86-186-6233-1526

China - Wuhan
Tel: 86-27-5980-5300

China - Xian
Tel: 86-29-8833-7252

China - Xiamen
Tel: 86-592-2388138

China - Zhuhai
Tel: 86-756-3210040

ASIA/PACIFIC

India - Bangalore
Tel: 91-80-3090-4444

India - New Delhi
Tel: 91-11-4160-8631

India - Pune
Tel: 91-20-4121-0141

Japan - Osaka
Tel: 81-6-6152-7160

Japan - Tokyo
Tel: 81-3-6880-3770

Korea - Daegu
Tel: 82-53-744-4301

Korea - Seoul
Tel: 82-2-554-7200

Malaysia - Kuala Lumpur
Tel: 60-3-7651-7906

Malaysia - Penang
Tel: 60-4-227-8870

Philippines - Manila
Tel: 63-2-634-9065

Singapore
Tel: 65-6334-8870

Taiwan - Hsin Chu
Tel: 886-3-577-8366

Taiwan - Kaohsiung
Tel: 886-7-213-7830

Taiwan - Taipei
Tel: 886-2-2508-8600

Thailand - Bangkok
Tel: 66-2-694-1351

Vietnam - Ho Chi Minh
Tel: 84-28-5448-2100

EUROPE

Austria - Wels
Tel: 43-7242-2244-39
Fax: 43-7242-2244-393

Denmark - Copenhagen
Tel: 45-4485-5910
Fax: 45-4485-2829

Finland - Espoo
Tel: 358-9-4520-820

France - Paris
Tel: 33-1-69-53-63-20
Fax: 33-1-69-30-90-79

Germany - Garching
Tel: 49-8931-9700

Germany - Haan
Tel: 49-2129-3766400

Germany - Heilbronn
Tel: 49-7131-72400

Germany - Karlsruhe
Tel: 49-721-625370

Germany - Munich
Tel: 49-89-627-144-0
Fax: 49-89-627-144-44

Germany - Rosenheim
Tel: 49-8031-354-560

Israel - Ra'anana
Tel: 972-9-744-7705

Italy - Milan
Tel: 39-0331-742611
Fax: 39-0331-466781

Italy - Padova
Tel: 39-049-7625286

Netherlands - Drunen
Tel: 31-416-690399
Fax: 31-416-690340

Norway - Trondheim
Tel: 47-7288-4388

Poland - Warsaw
Tel: 48-22-3325737

Romania - Bucharest
Tel: 40-21-407-87-50

Spain - Madrid
Tel: 34-91-708-08-90
Fax: 34-91-708-08-91

Sweden - Gothenberg
Tel: 46-31-704-60-40

Sweden - Stockholm
Tel: 46-8-5090-4654

UK - Wokingham
Tel: 44-118-921-5800
Fax: 44-118-921-5820