

TLV621x0 Step-Down Converter Evaluation Module User's Guide



ABSTRACT

This user's guide describes the characteristics, operation, and use of the Texas Instruments TLV62130 and TLV62150 evaluation modules (EVM). The TLV62130EVM-505 and TLV62150EVM-505 evaluate the performance of the TLV62130 or TLV62150 IC in a standard buck regulator topology. The EVM converts a 4-V to 17-V input voltage to 3.3 V and provides up to 3 A (1 A for the TLV62150EVM-505) of output current. The user's guide includes setup instructions for the EVM, the printed-circuit board layout, the schematic diagram, the bill of materials, and test results for the EVM. After the release of the A-version devices in the summer of 2013, these EVMs are assembled with the TLV62130A or TLV62150A.

Table of Contents

1 Introduction	3
1.1 Background.....	3
1.2 Performance Specification.....	3
1.3 Modifications.....	3
2 Setup	4
2.1 Input/Output Connector Descriptions.....	4
2.2 Setup.....	4
3 TLV621x0EVM-505 Test Results	5
4 Board Layout	14
5 Schematic and Bill of Materials	17
5.1 Schematic.....	17
5.2 Bill of Materials.....	18
6 Revision History	18

List of Figures

Figure 1-1. Loop Response Measurement Modification.....	4
Figure 3-1. Efficiency With 1- μ H Inductor and F_{SW} = LOW (High Frequency).....	5
Figure 3-2. Efficiency With 2.2- μ H Inductor and F_{SW} = LOW (High Frequency).....	5
Figure 3-3. Efficiency With 2.2- μ H Inductor and F_{SW} = HIGH (Low Frequency).....	6
Figure 3-4. Load Regulation With 2.2- μ H Inductor and F_{SW} = LOW (High Frequency).....	6
Figure 3-5. Line Regulation With 2.2- μ H Inductor and F_{SW} = LOW (High Frequency) and I_{OUT} = 1 A.....	7
Figure 3-6. Loop Response With 2.2- μ H Inductor and F_{SW} = LOW (High Frequency) and V_{IN} = 12 V and I_{OUT} = 1 A.....	7
Figure 3-7. Input Voltage Ripple With 2.2- μ H Inductor and F_{SW} = LOW (High Frequency) and V_{IN} = 12 V and I_{OUT} = 1 A.....	8
Figure 3-8. Output Voltage Ripple With 2.2- μ H Inductor and F_{SW} = LOW (High Frequency) and V_{IN} = 12 V and I_{OUT} = 1 A.....	8
Figure 3-9. Output Voltage Ripple With 2.2- μ H Inductor and F_{SW} = HIGH (Low Frequency) and V_{IN} = 12 V and I_{OUT} = 1 A.....	9
Figure 3-10. Load Transient Response With 1- μ H Inductor and V_{IN} = 12 V.....	9
Figure 3-11. Load Transient Response With 2.2- μ H Inductor and V_{IN} = 12 V.....	10
Figure 3-12. Start-Up on EN with 1-A Load and V_{IN} = 12 V.....	10
Figure 3-13. Shutdown on EN with 1-A Load and V_{IN} = 12 V.....	11
Figure 3-14. TLV62130 Prebias Start-Up and Shutdown on EN With 1-A Load and V_{IN} = 12 V.....	11
Figure 3-15. TLV62130A Prebias Start-Up and Shutdown on EN With 1-A Load and V_{IN} = 12 V.....	12
Figure 3-16. Thermal Performance With 1- μ H Inductor.....	13
Figure 3-17. Thermal Performance With 2.2- μ H Inductor.....	13
Figure 4-1. Assembly Layer.....	14
Figure 4-2. Top Layer Routing.....	14
Figure 4-3. Internal Layer-1 Routing.....	15
Figure 4-4. Internal Layer-2 Routing.....	15

Figure 4-5. Bottom Layer Routing.....	16
Figure 5-1. TLV621x0EVM-505 Schematic.....	17

List of Tables

Table 1-1. Performance Specification Summary.....	3
Table 5-1. TLV621x0EVM-505 Bill of Materials.....	18

Trademarks

All trademarks are the property of their respective owners.

1 Introduction

The TLV62130 is a 3-A, synchronous, step-down converter in a 3-mm × 3-mm, 16-pin QFN package.

The TLV62150 is a 1-A, synchronous, step-down converter in a 3-mm × 3-mm, 16-pin QFN package.

1.1 Background

The TLV62130EVM-505 (HPA505-004) uses the TLV62130A and is set to a 3.3-V output. The EVM operates with full-rated performance with an input voltage between 4 V and 17 V.

The TLV62150EVM-505 (HPA505-005) uses the TLV62150A and is set to a 3.3-V output. The EVM operates with full-rated performance with an input voltage between 4 V and 17 V.

1.2 Performance Specification

[Table 1-1](#) provides a summary of the TLV621x0EVM-505 performance specifications. All specifications are given for an ambient temperature of 25°C.

Table 1-1. Performance Specification Summary

SPECIFICATION	TEST CONDITIONS	MIN	TYP	MAX	UNIT
Input voltage		4		17	V
Output voltage	PWM mode of operation	3.244	3.327	3.410	V
Output current	TLV62130EVM-505	0		3000	mA
	TLV62150EVM-505	0		1000	mA
Peak efficiency	TLV62130EVM-505, F _{SW} = LOW (high frequency)		93.2%		
Peak efficiency	TLV62150EVM-505, F _{SW} = HIGH (low frequency)		95.0%		
Soft-start time			1.65		ms

1.3 Modifications

The printed-circuit board (PCB) for this EVM is designed to accommodate various modifications that affect the performance of the IC. Additional input and output capacitors can be added, the soft-start time can be changed, and the loop response of the IC can be measured.

1.3.1 Input and Output Capacitors

C2 is provided for an additional input capacitor. This capacitor is not required for proper operation but can be used to reduce the input voltage ripple.

C7 is provided for an input capacitor on the AVIN pin. This capacitor is required and populated on the TLV62130EVM-505. It can be added on the other EVM version but is not required.

C4 is provided for an additional output capacitor. This capacitor is not required for proper operation but can be used to reduce the output voltage ripple and to improve the load transient response. The total output capacitance must remain within the recommended range in the data sheet for proper operation.

1.3.2 Soft-Start Time

C5 controls the soft-start time of the output voltage on the TLV621x0EVM-505. It can be changed for a shorter or slower ramp up of V_{OUT}. Note that as the value of C5 is decreased, the inrush current increases.

1.3.3 Loop Response Measurement

The loop response of the TLV621x0EVM-505 can be measured with two simple changes to the circuitry. First, install a 10-Ω resistor across the pads in the middle of the back of the PCB. The pads are spaced to allow installation of 0805- or 0603-sized resistors. Second, cut the trace between the via on the output voltage and the trace that connects to the VOS pin via. These changes are shown in [Figure 1-1](#). With these changes, an ac signal (10-mV, peak-to-peak amplitude recommended) can be injected into the control loop across the added resistor.

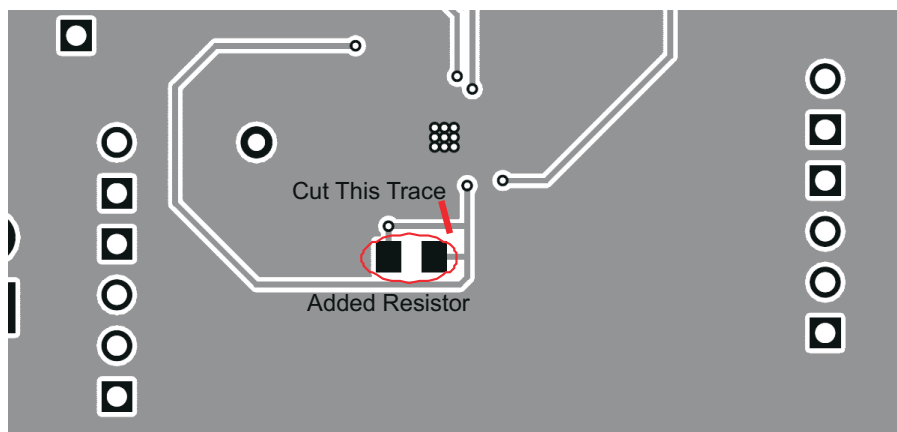

Figure 1-1. Loop Response Measurement Modification

2 Setup

This section describes how to properly use the TLV621x0EVM-505.

2.1 Input/Output Connector Descriptions

J1 – VIN	Positive input connection from the input supply for the EVM. Use when the steady-state input current is less than 1 A. Otherwise, use J8.
J2 – S+/S–	Input voltage sense connections. Measure the input voltage at this point.
J3 – GND	Return connection from the input supply for the EVM. Use when the steady-state input current is less than 1 A. Otherwise, use J8.
J4 – VOUT	Output voltage connection. Use when the steady-state output current is less than 1 A. Otherwise, use J9.
J5 – S+/S–	Output voltage sense connections. Measure the output voltage at this point.
J6 – GND	Output return connection. Use when the steady-state output current is less than 1 A. Otherwise, use J9.
J7 – PG/GND	The PG output appears on pin 1 of this header with a convenient ground on pin 2.
J8 – VIN/GND	Pin 1 is the positive input connection with pin 2, serving as the return connection. Use this terminal block if the steady-state input current is greater than 1 A.
J9 – VOUT/GND	Pin 2 is the output voltage connection with pin 1, serving as the output return connection. Use this terminal block if the steady-state output current is greater than 1 A.
J10 – SS/TR & GND	The SS/TR input appears on pin 1 of this header with a convenient ground on pin 2.
JP1 – EN	EN pin input jumper. Place the supplied jumper across ON and EN to turn on the IC. Place the jumper across OFF and EN to turn off the IC.
JP2 – DEF	DEF pin input jumper. Place the supplied jumper across HIGH and DEF to set the output voltage at 5% above nominal. Place the jumper across LOW and DEF to set the output voltage at the nominal level.
JP3 – FSW	FSW pin input jumper. Place the supplied jumper across 1.25 MHz and FSW to operate the IC at a reduced switching frequency of nominally 1.25 MHz. Place the jumper across 2.5 MHz and FSW to operate the IC at the full switching frequency of nominally 2.5 MHz.
JP4 – PG Pullup Voltage	PG pin pullup voltage jumper. Place the supplied jumper on JP4 to connect the PG pin pullup resistor to Vout. Alternatively, the jumper can be removed and a different voltage can be supplied on pin 2 to pull up the PG pin to a different level. This externally applied voltage must remain below 7 V.

2.2 Setup

To operate the EVM, set jumpers JP1 through JP4 to the desired positions per [Section 2.1](#). Connect the input supply to either J1 and J3 or J8, and connect the load to either J4 and J6 or J9.

3 TLV621x0EVM-505 Test Results

This section provides test results of the TLV621x0EVM-505.

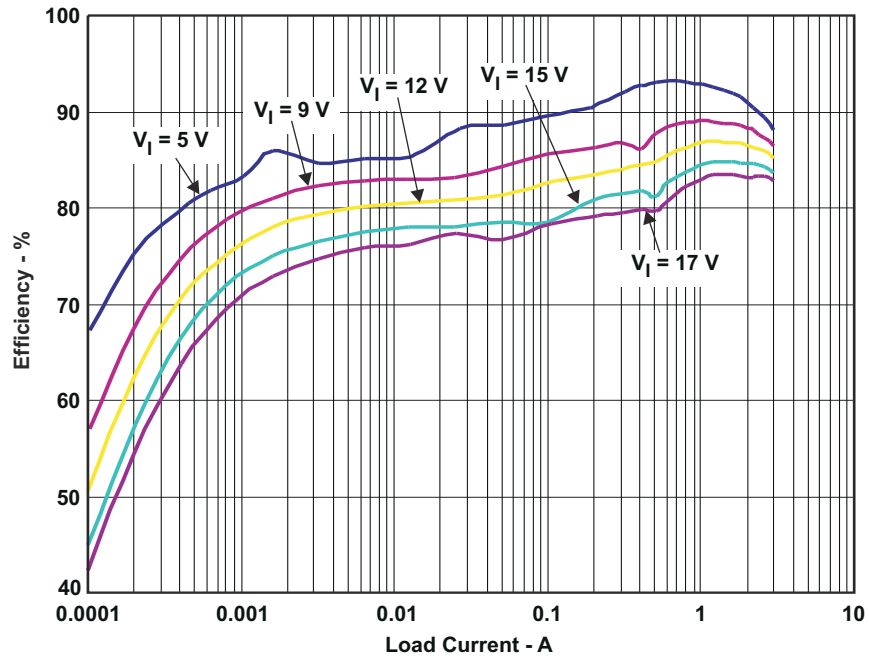

Figure 3-1. Efficiency With 1- μ H Inductor and F_{SW} = LOW (High Frequency)

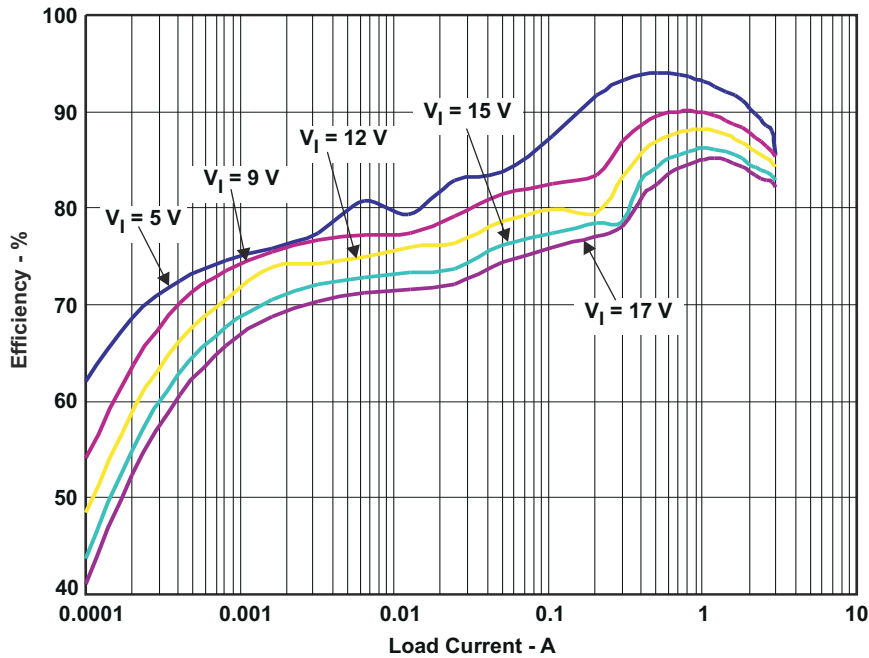

Figure 3-2. Efficiency With 2.2- μ H Inductor and F_{SW} = LOW (High Frequency)

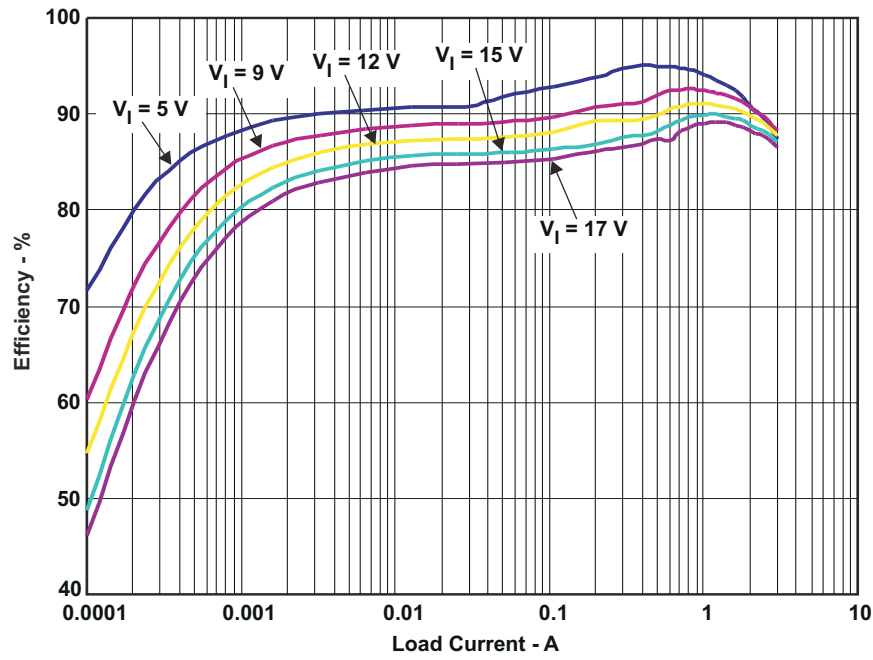

Figure 3-3. Efficiency With 2.2- μ H Inductor and $F_{SW} = \text{HIGH}$ (Low Frequency)

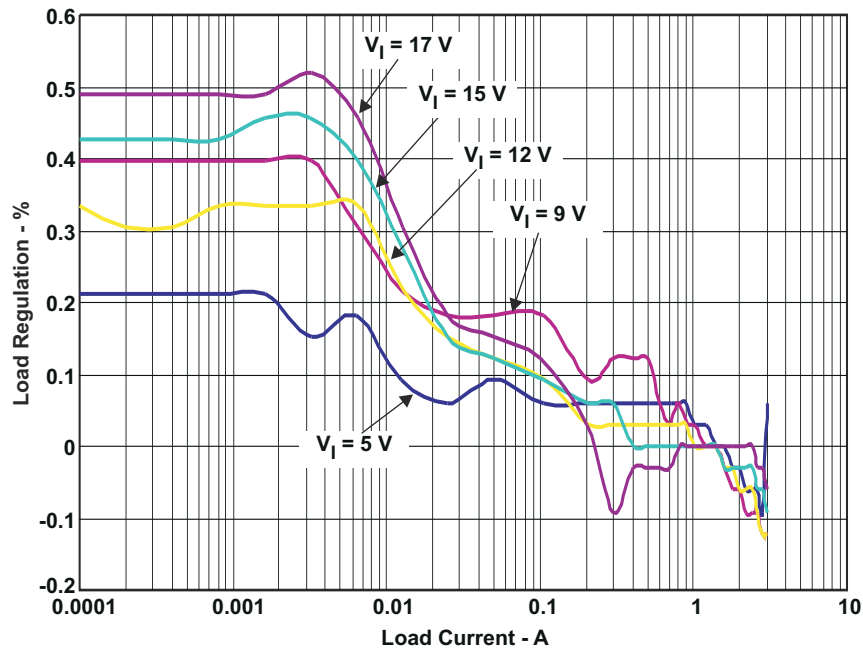

Figure 3-4. Load Regulation With 2.2- μ H Inductor and $F_{SW} = \text{LOW}$ (High Frequency)

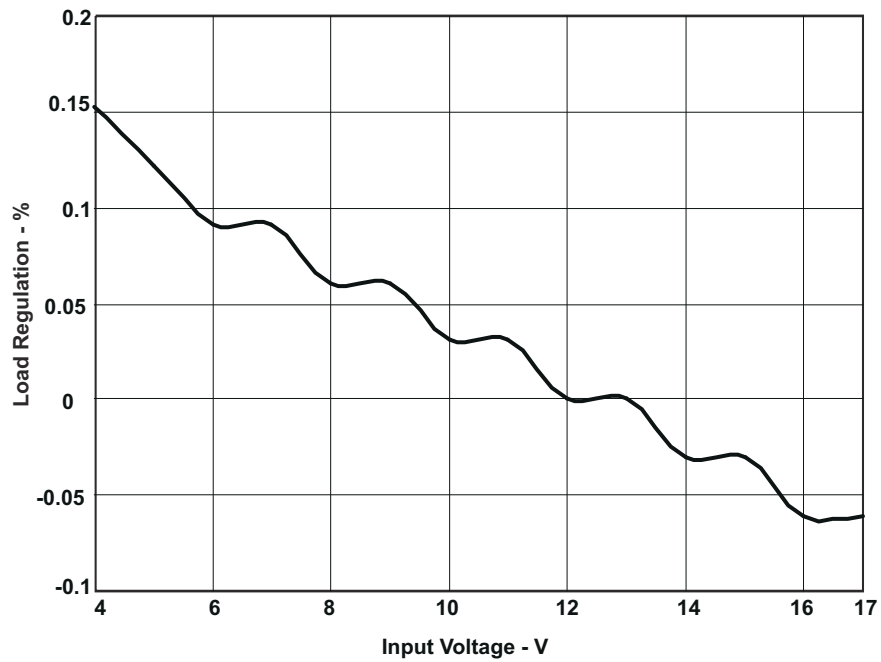

Figure 3-5. Line Regulation With 2.2- μ H Inductor and $F_{SW} = \text{LOW}$ (High Frequency) and $I_{OUT} = 1 \text{ A}$

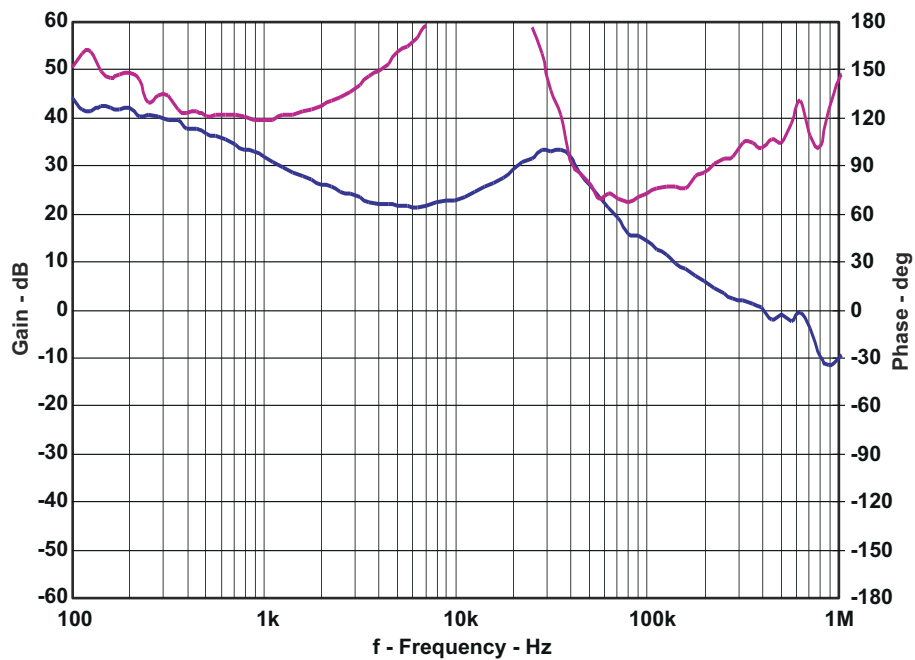

Figure 3-6. Loop Response With 2.2- μ H Inductor and $F_{SW} = \text{LOW}$ (High Frequency) and $V_{IN} = 12 \text{ V}$ and $I_{OUT} = 1 \text{ A}$

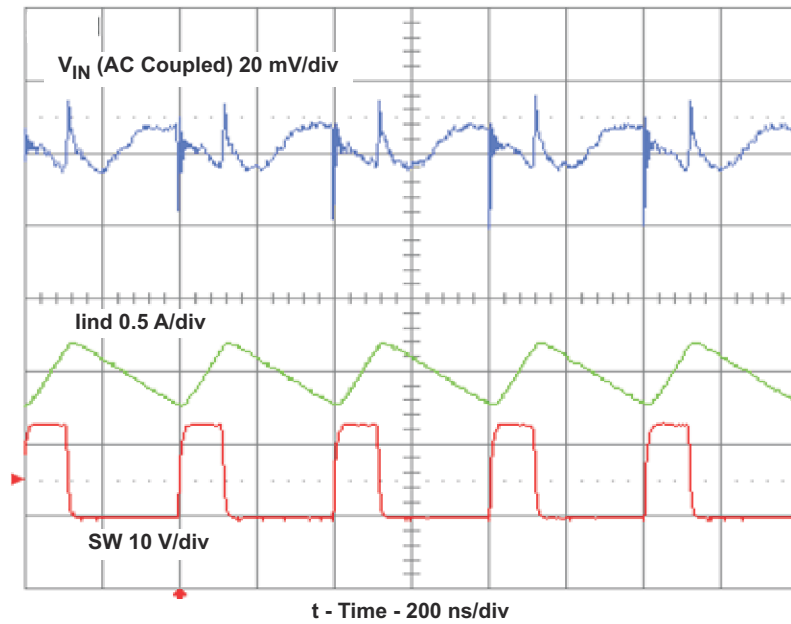

Figure 3-7. Input Voltage Ripple With 2.2- μ H Inductor and F_{SW} = LOW (High Frequency) and V_{IN} = 12 V and I_{OUT} = 1 A

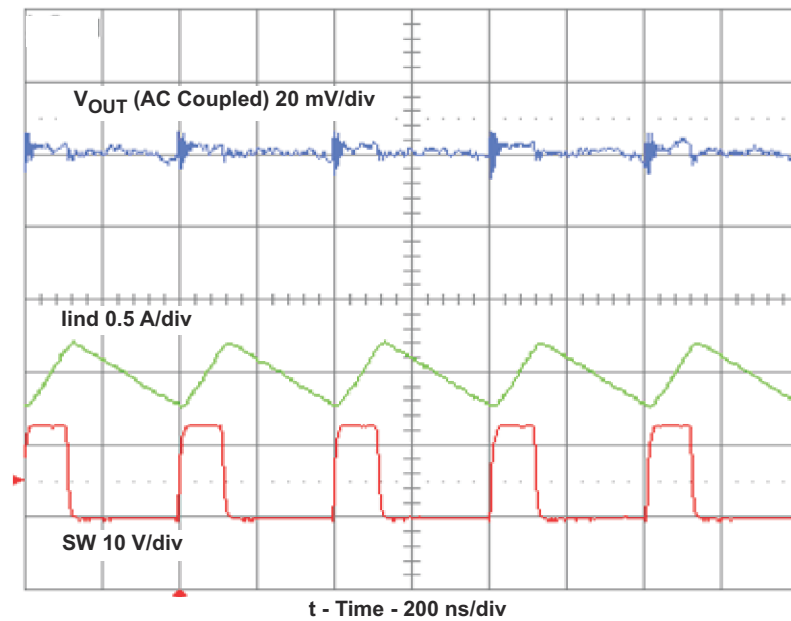

Figure 3-8. Output Voltage Ripple With 2.2- μ H Inductor and F_{SW} = LOW (High Frequency) and V_{IN} = 12 V and I_{OUT} = 1 A

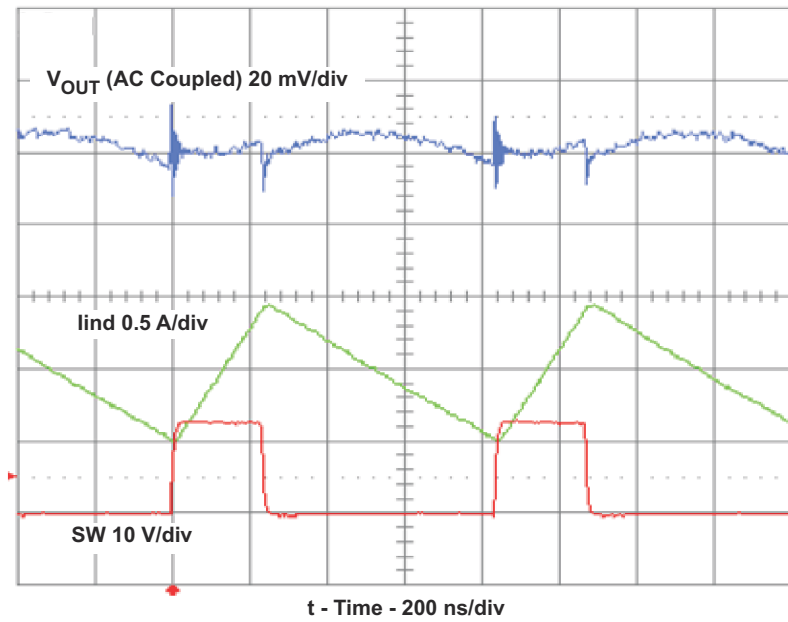

Figure 3-9. Output Voltage Ripple With 2.2- μ H Inductor and $F_{SW} = \text{HIGH}$ (Low Frequency) and $V_{IN} = 12 \text{ V}$ and $I_{OUT} = 1 \text{ A}$

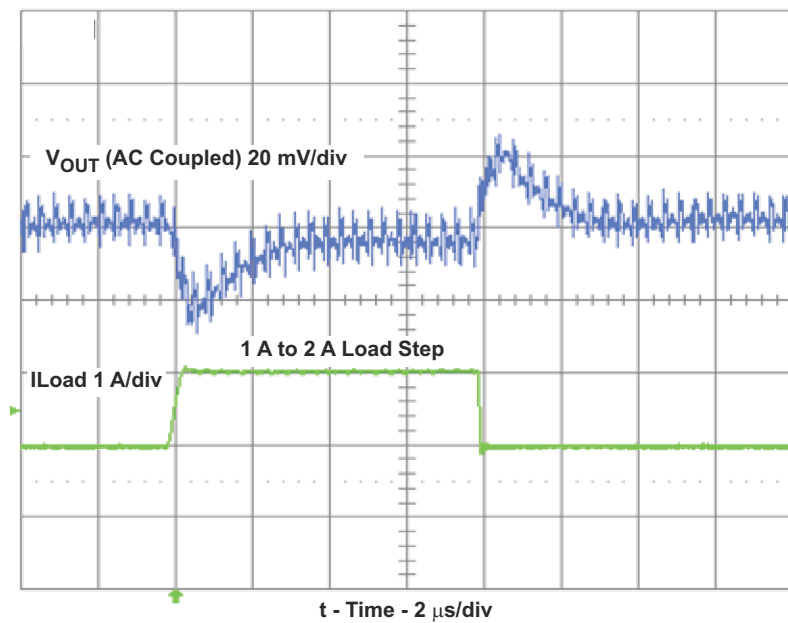

Figure 3-10. Load Transient Response With 1- μ H Inductor and $V_{IN} = 12 \text{ V}$

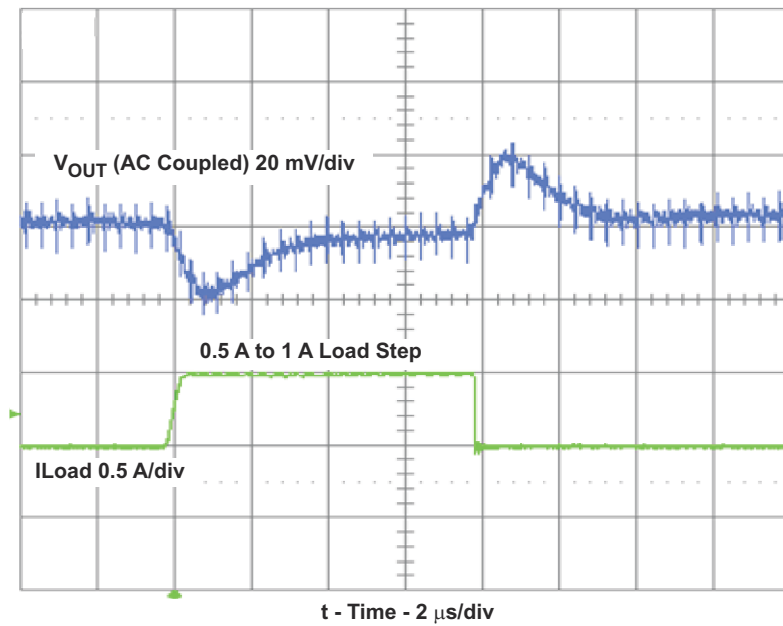

Figure 3-11. Load Transient Response With 2.2- μ H Inductor and $V_{IN} = 12$ V

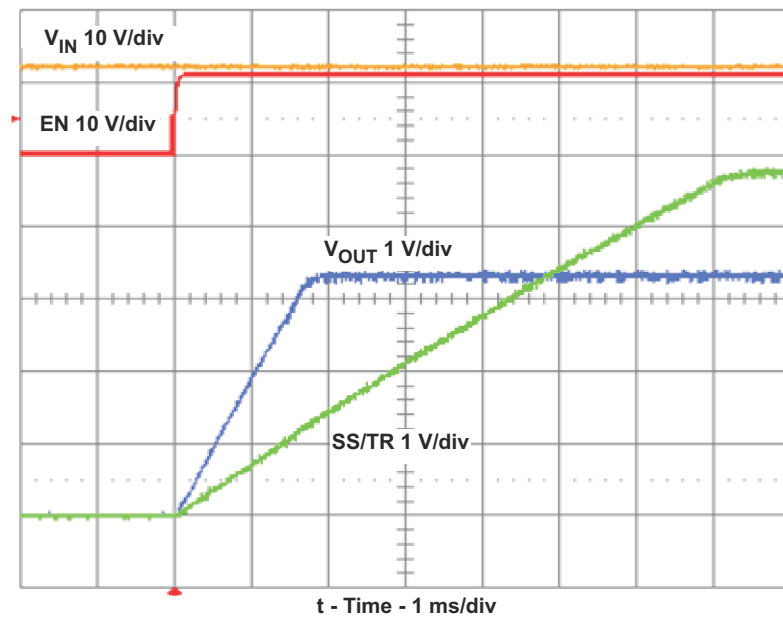

Figure 3-12. Start-Up on EN with 1-A Load and $V_{IN} = 12$ V

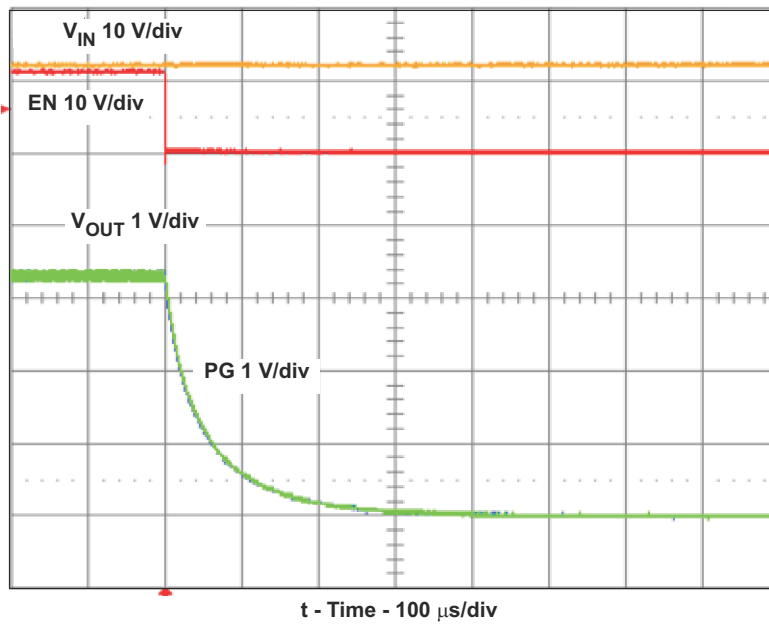

Figure 3-13. Shutdown on EN with 1-A Load and $V_{IN} = 12\text{ V}$

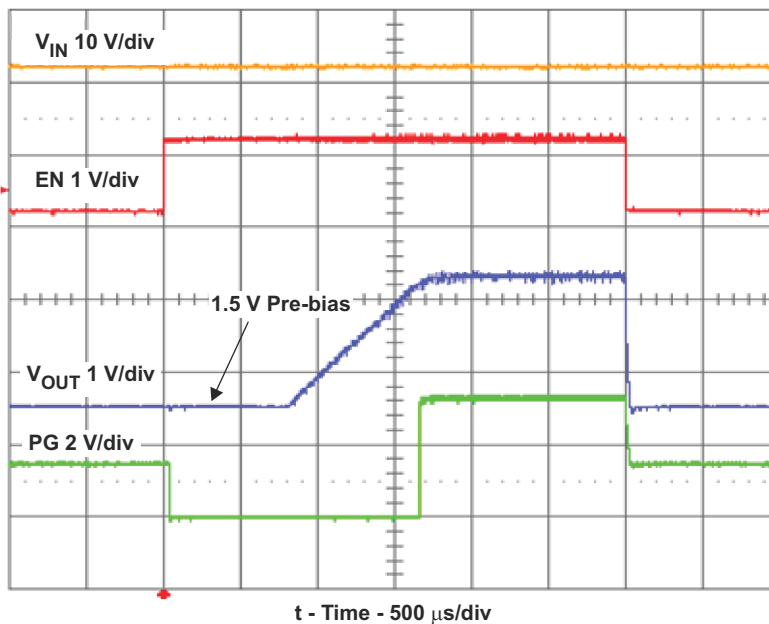

Figure 3-14. TLV62130 Prebias Start-Up and Shutdown on EN With 1-A Load and $V_{IN} = 12\text{ V}$

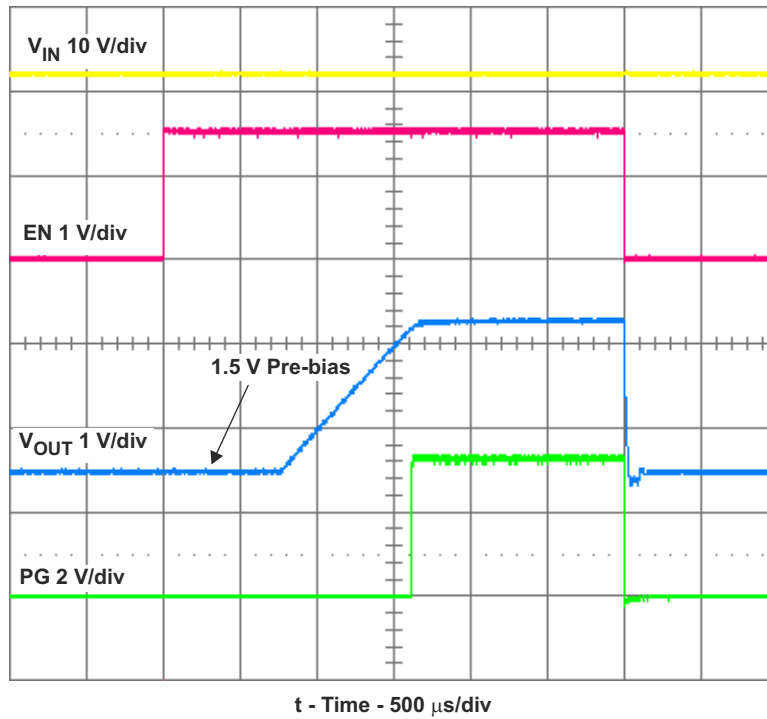
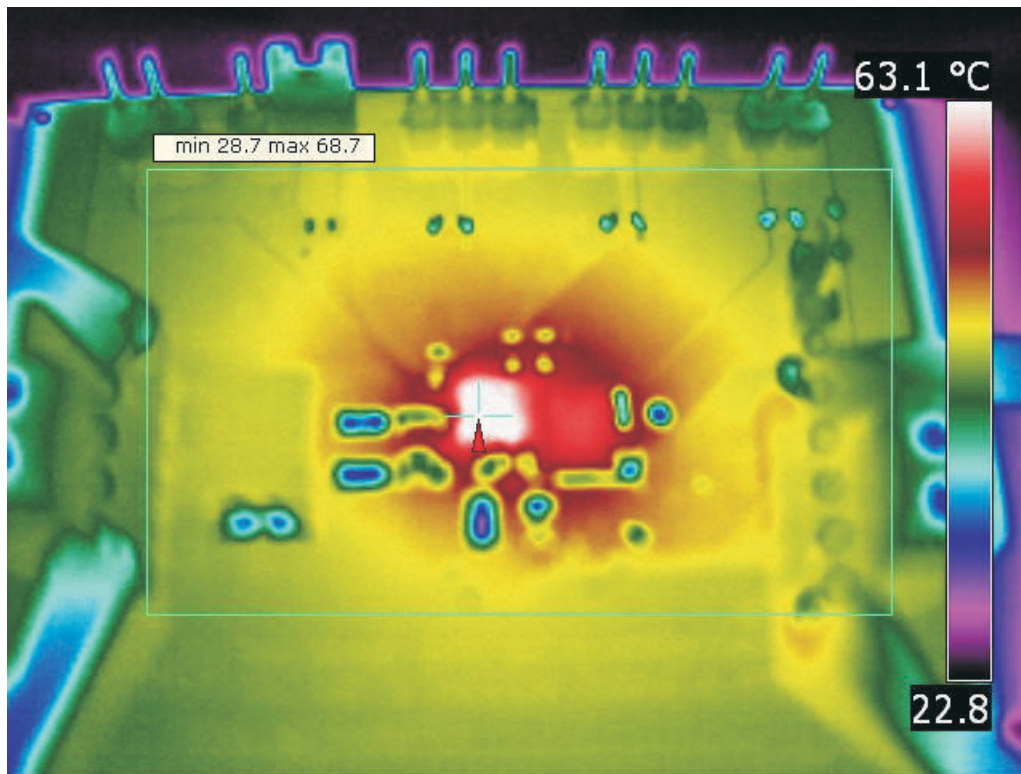
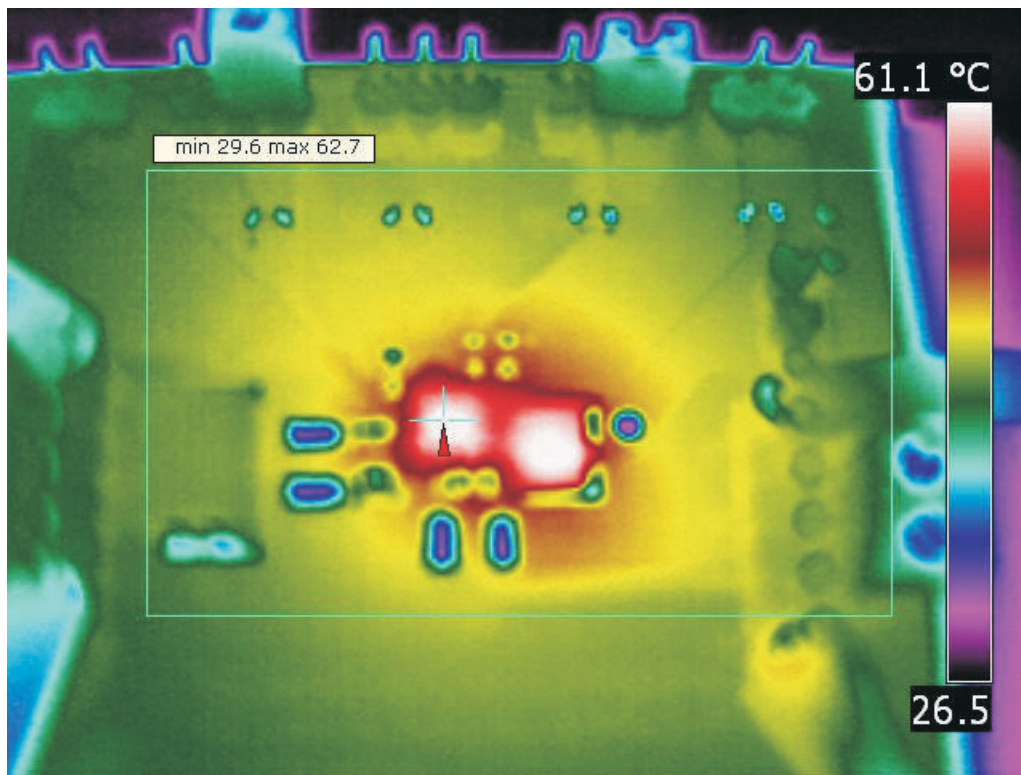

Figure 3-15. TLV62130A Prebias Start-Up and Shutdown on EN With 1-A Load and V_{IN} = 12 V



$V_{IN} = 12\text{ V}$ and $I_{OUT} = 3\text{ A}$ and $F_{SW} = \text{LOW}$ (high frequency)

Figure 3-16. Thermal Performance With 1- μH Inductor



$V_{IN} = 12\text{ V}$ and $I_{OUT} = 3\text{ A}$ and $F_{SW} = \text{HIGH}$ (low frequency)

Figure 3-17. Thermal Performance With 2.2- μH Inductor

4 Board Layout

This section provides the TLV621x0EVM-505 board layout and illustrations.

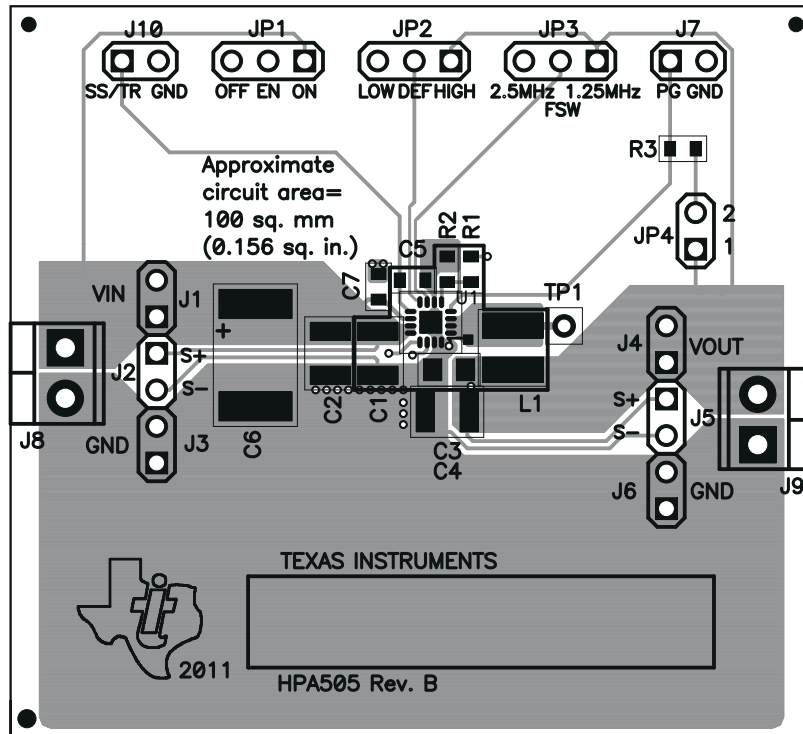

Figure 4-1. Assembly Layer

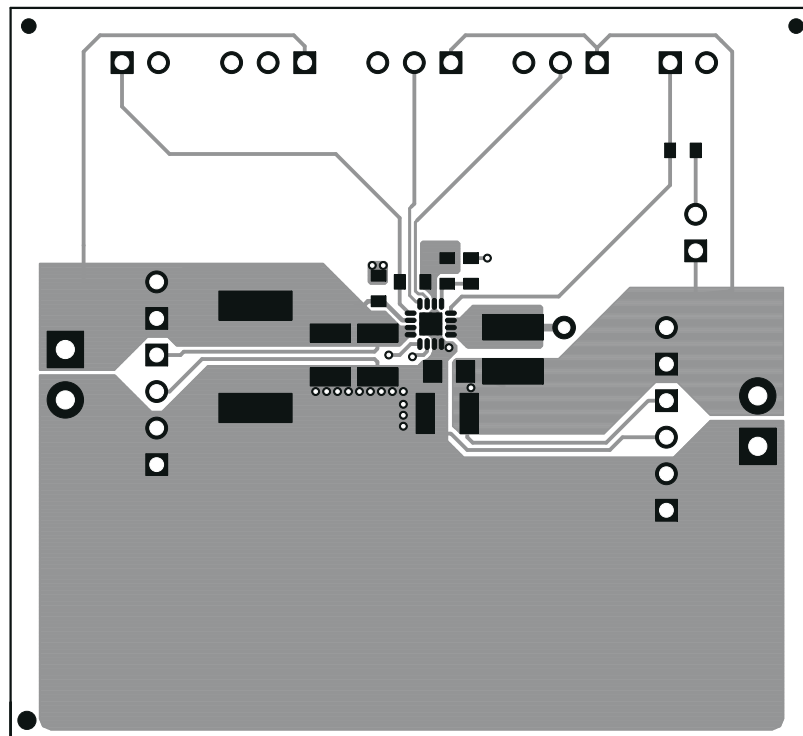

Figure 4-2. Top Layer Routing

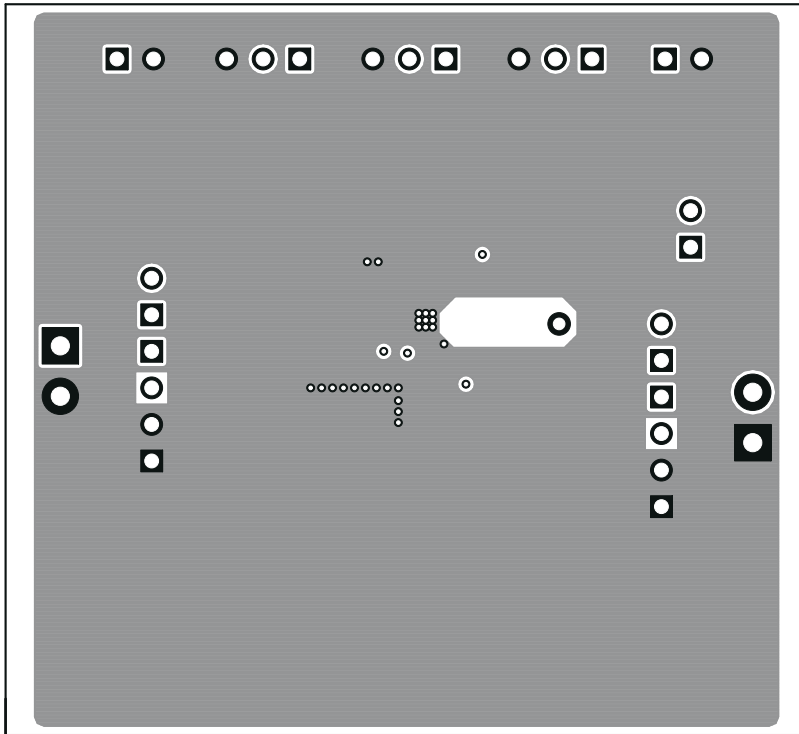

Figure 4-3. Internal Layer-1 Routing

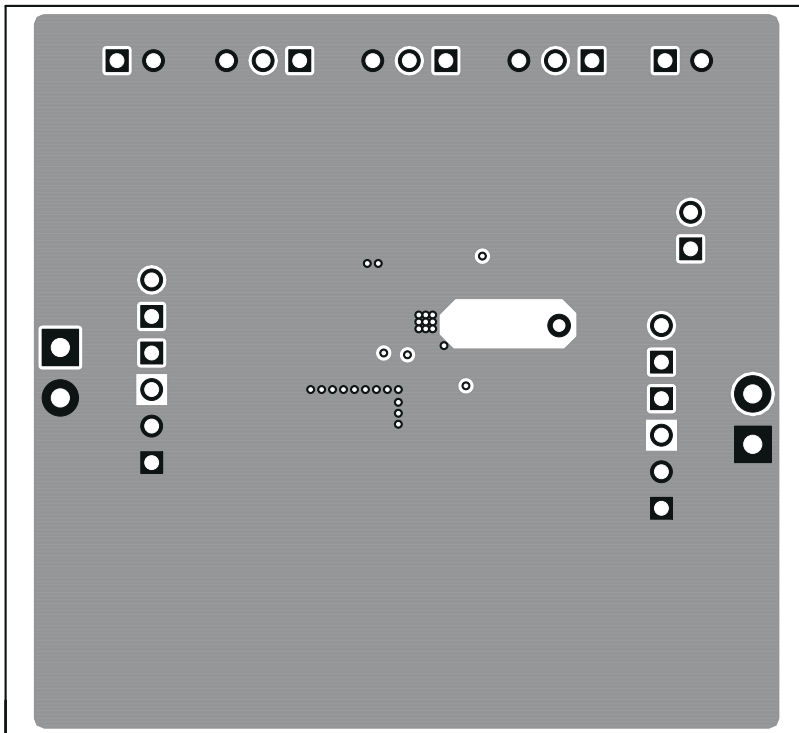

Figure 4-4. Internal Layer-2 Routing

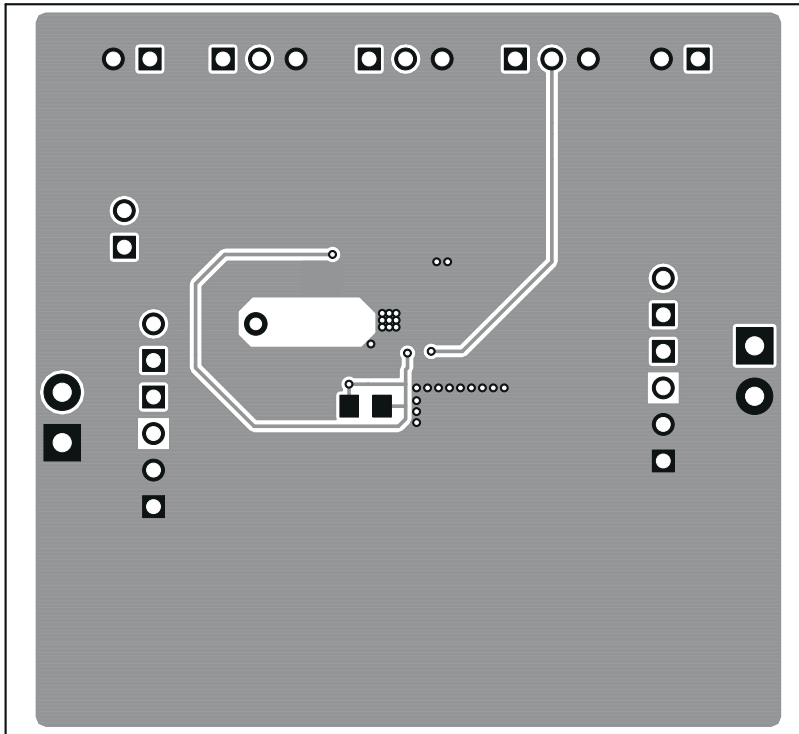

Figure 4-5. Bottom Layer Routing

5 Schematic and Bill of Materials

This section provides the TLV621x0EVM-505 schematic and bill of materials.

5.1 Schematic

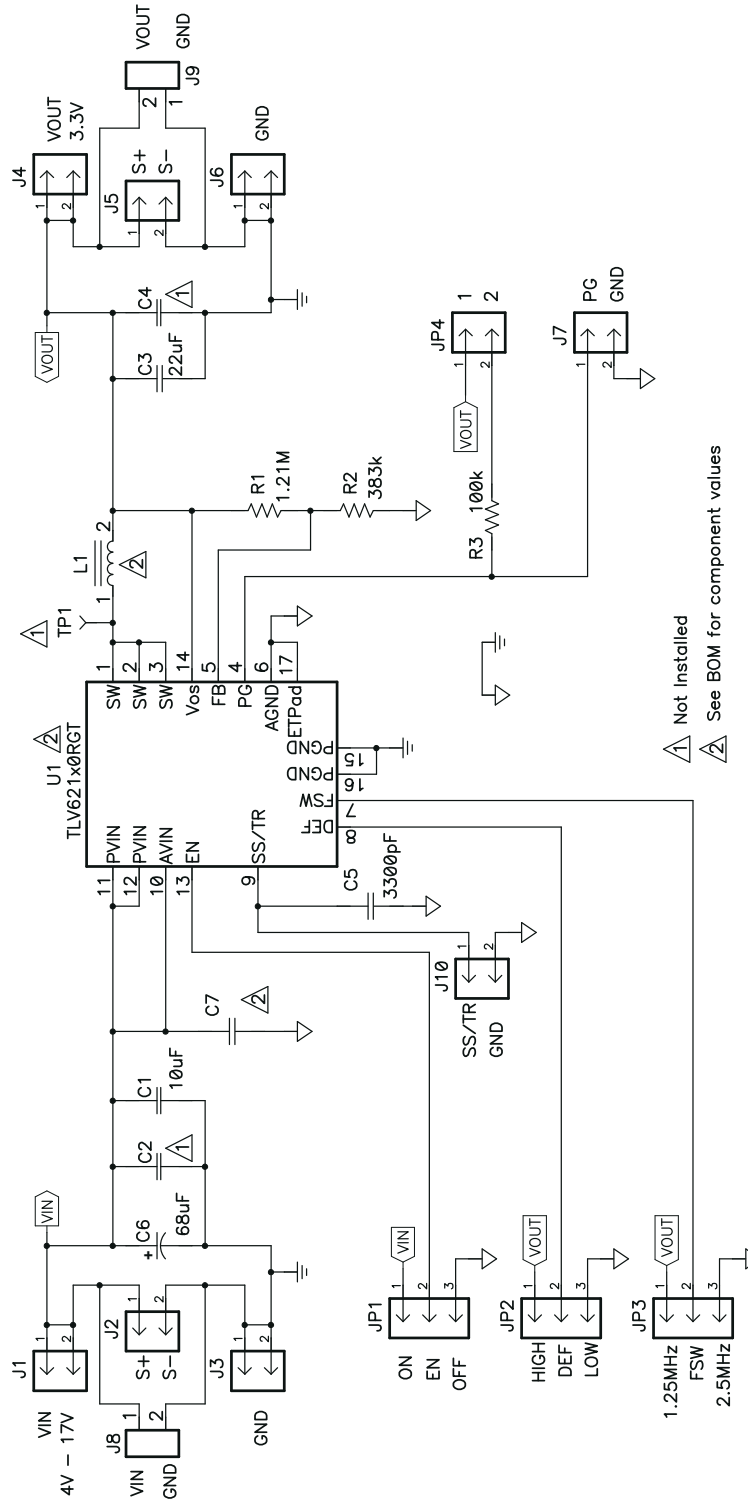

Figure 5-1. TLV621x0EVM-505 Schematic

5.2 Bill of Materials

Table 5-1. TLV621x0EVM-505 Bill of Materials

COUNT		REFDES	VALUE	DESCRIPTION	SIZE	PART NUMBER	MFR
-004	-005						
1	1	C1	10 μ F	Capacitor, Ceramic, 25 V, X5R, 20%	1210	Std	Std
1	1	C3	22 μ F	Capacitor, Ceramic, 6.3 V, X5R, 20%	0805	Std	Std
1	1	C5	3300 pF	Capacitor, Ceramic, 25 V, X7R, 10%	0603	Std	Std
1	1	C6	68 μ F	Capacitor, Tantalum, 35 V, 68 μ F, \pm 20%	7361[V]	TPSV686M035R0150	AVX
1	0	C7	0.1 μ F	Capacitor, Ceramic, 25 V, X5R, 20%	0603	Std	Std
1	0	L1	1.0 μ H	Inductor, Power, 5.1 A, \pm 20%	0.165 \times 0.165 inch	XFL4020-102ME	Coilcraft
0	1	L1	2.2 μ H	Inductor, Power, 3.5 A, \pm 20%	0.165 \times 0.165 inch	XFL4020-222ME	Coilcraft
1	1	R1	1.21M	Resistor, Chip, 1/16W, 1%	0603	Std	Std
1	1	R2	383 k	Resistor, Chip, 1/16W, 1%	0603	Std	Std
1	1	R3	100 k	Resistor, Chip, 1/16W, 1%	0603	Std	Std
1	0	U1 ⁽¹⁾	TLV62130ARGT	IC, 17-V, 3-A Step-Down Converter in 3-mm \times 3-mm QFN Package	3-mm \times 3-mm QFN	TLV62130ARGT	TI
0	1	U1 ⁽¹⁾	TLV62150ARGT	IC, 17-V, 1-A Step-Down Converter in 3-mm \times 3-mm QFN Package	3-mm \times 3-mm QFN	TLV62150ARGT	TI

- (1) EVMs made before August of 2013 use the non-A version of U1. The only difference between these devices is the operation of the PG pin when the device is disabled, as shown in [Figure 3-14](#) and [Figure 3-15](#).

6 Revision History

NOTE: Page numbers for previous revisions may differ from page numbers in the current version.

Changes from Revision A (July 2013) to Revision B (May 2021)

Page

- Changed user's guide title..... 3
- Updated the numbering format for tables, figures, and cross-references throughout the document.3

IMPORTANT NOTICE AND DISCLAIMER

TI PROVIDES TECHNICAL AND RELIABILITY DATA (INCLUDING DATA SHEETS), DESIGN RESOURCES (INCLUDING REFERENCE DESIGNS), APPLICATION OR OTHER DESIGN ADVICE, WEB TOOLS, SAFETY INFORMATION, AND OTHER RESOURCES "AS IS" AND WITH ALL FAULTS, AND DISCLAIMS ALL WARRANTIES, EXPRESS AND IMPLIED, INCLUDING WITHOUT LIMITATION ANY IMPLIED WARRANTIES OF MERCHANTABILITY, FITNESS FOR A PARTICULAR PURPOSE OR NON-INFRINGEMENT OF THIRD PARTY INTELLECTUAL PROPERTY RIGHTS.

These resources are intended for skilled developers designing with TI products. You are solely responsible for (1) selecting the appropriate TI products for your application, (2) designing, validating and testing your application, and (3) ensuring your application meets applicable standards, and any other safety, security, regulatory or other requirements.

These resources are subject to change without notice. TI grants you permission to use these resources only for development of an application that uses the TI products described in the resource. Other reproduction and display of these resources is prohibited. No license is granted to any other TI intellectual property right or to any third party intellectual property right. TI disclaims responsibility for, and you will fully indemnify TI and its representatives against, any claims, damages, costs, losses, and liabilities arising out of your use of these resources.

TI's products are provided subject to [TI's Terms of Sale](#) or other applicable terms available either on ti.com or provided in conjunction with such TI products. TI's provision of these resources does not expand or otherwise alter TI's applicable warranties or warranty disclaimers for TI products.

TI objects to and rejects any additional or different terms you may have proposed.

Mailing Address: Texas Instruments, Post Office Box 655303, Dallas, Texas 75265
Copyright © 2022, Texas Instruments Incorporated