



User Guide

MP2672A Evaluation Kit (EVKT-MP2672A)

Table of Contents

Overview	0
Introduction	0
Kit Contents	0
Features and Benefits	0
Kit Specifications	0
Section 1. Hardware Specifications	0
1.1 Personal Computer Requirements	0
1.2 EV2672A-D-00A Specifications.....	0
1.3 EVKT-USBI2C-02 Specifications	0
Section 2. Software Requirements	0
2.1 Software Installation Procedure	0
Section 3. Evaluation Kit Test Set-Up.....	6
3.1 Hardware Set-Up.....	6
3.2 Powering Up the EVB.....	6
3.3 Software Set-Up	0
3.4 Device Programming Instructions	0
3.5 Troubleshooting Tips.....	9
Section 4. Ordering Information	0

Overview

Introduction

The EVKT-MP2672A is an evaluation kit for the MP2672A, which can be controlled by the GUI to charge and discharge 2-cell batteries. Its layout accommodates most commonly used components. The default function of this board is preset for host-control mode, and the battery regulation voltage is preset to 8.4V for 2-cell Li-ion batteries.

Kit Contents

EVKT-MP2672A kit contents (items below can be ordered separately, and the GUI installation file and supplemental documents can be downloaded from the MPS website).

#	Part Number	Item	Quantity
1	EV2672A-D-00A	MP2672A evaluation board	1
2	EVKT-USB2C-02-BAG	Includes one USB to I ² C USB communication interface, one USB cable, and one ribbon cable	1

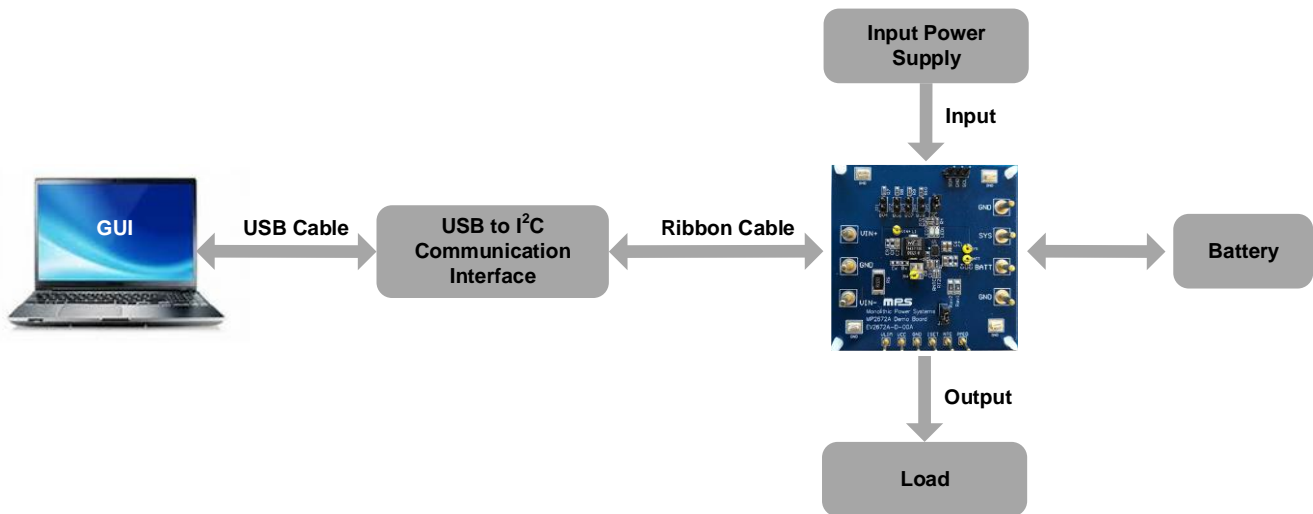

Figure 1: EVKT-MP2672A Evaluation Kit Set-Up

Features and Benefits

- 4.5V to 6.0V Operating Input Voltage
- Up to 2A Configurable Charge Current for Battery with 2 Cells in Series
- Compatible with Host-Control and Standalone Mode
- NVDC Power Path Management
- Configurable Input Voltage Limit
- Configurable Charge Voltage with 0.5% Accuracy
- No External Sense Resistor Required
- Integrated Cell-Balancing Circuit for Cell Mismatch
- Preconditioning for Fully Depleted Battery
- Flexible New Charging Cycle Initiation
- Charging Operation Indicator in Standalone Mode
- Missing Battery Detection in Host-Control Mode
- I²C Port for Flexible System Parameter Setting and Status Reporting in Host-Control Mode
- Negative Temperature Coefficient Pin for Temperature Monitoring Compliant with JEITA
- Built-In Charging Protection and Programmable Safety Timer
- MOSFET Cycle-by-Cycle Over-Current Protection (OCP)
- Thermal Regulation and Thermal Shutdown

⚠ Any changes made in I²C mode are not retained once the EVB is powered down.

⚠ Information written in OTP mode cannot be changed.

Adjustable features are outlined below:

I ² C	OTP
<ul style="list-style-type: none"> • Battery Regulation Voltage • Battery Pre-Charge Voltage • Cell Balance Start Threshold • Cell Voltage Mismatch Threshold • Fast Charge Current • Switching Frequency • Charge Timer 	<ul style="list-style-type: none"> • Battery Regulation Voltage • Battery Pre-Charge Voltage • Cell Balance Start Threshold • Cell Voltage Mismatch Threshold • Fast Charge Current • Switching Frequency • Thermal Regulation Threshold • Auto-Recharge_EN Default Status • Balance_EOC_EN Default Status • NVDC Mode_EN Default Status

Kit Specifications

Feature	Specification
Supply for Board	4.5V to 6.0V
Operating Input Voltage	4.5V to 6.0V
Charge Capability	Maximum 2A/8.4V (I ² C-configurable)
System Load Capability	Maximum 2.5A / BATT + 300mV (I ² C-configurable)
Operating Systems Supported	Windows XP, 7, or later
System Requirements	Minimum 22.2MB free
GUI Software	MP2672A V1.2

Section 1. Hardware Specifications

1.1 Personal Computer Requirements

The following minimum conditions must met to use the EVKT-MP2672A:

- Operating System of Windows XP, 7, or later
- Net Framework 4.0
- PC with a minimum of one available USB port
- At least 22.2MB of free space

1.2 EV2672A-D-00A Specifications

The EV2672A-D-00A is an evaluation board for the MP2672A. For more information, refer to the EV2672A-D-00A datasheet.



Figure 2: EV2672A-D-00A Evaluation Board

Feature	Specification
Supply for Evaluation Board	4.5V to 6.0V
Operating Input Voltage	4.5V to 6.0V
Charge Capability	Maximum 2A/8.4V (I ² C-configurable)
System Load Capability	Maximum 2.5A/6.7V (I ² C-configurable)
EVB Size (LxW)	6.35cmx6.35cm

1.3 EVKT-USBI2C-02 Specifications

The EVKT-USBI2C-02 refers to the USB to I²C communication interface device, which connects the EVB, the PC, and its supporting accessories. It provides I²C capabilities. Together with MPS’s Virtual Bench Pro and GUI tools, it provides a quick and easy way to evaluate the performance of MPS digital products. For more details, refer to the EVKT-USBI2C-02 datasheet.



Figure 3: EVKT-USBI2C-02 Communication Interface

Section 2. Software Requirements

2.1 Software Installation Procedure

Configuration occurs through the MPS I²C GUI. Follow the instructions below to install the software:

Note: This software can be downloaded from MPS website.

1. Download and extract the zip package titled “Programming Tool-MP2672A.”
2. Double click the .exe file to open the set-up guide (see Figure 4). If a protection window comes up, click “More info,” then click “Run anyway.”
3. Follow the prompts in the set-up guide.
4. Wait for the status screen to verify that installation is complete (see Figure 5).

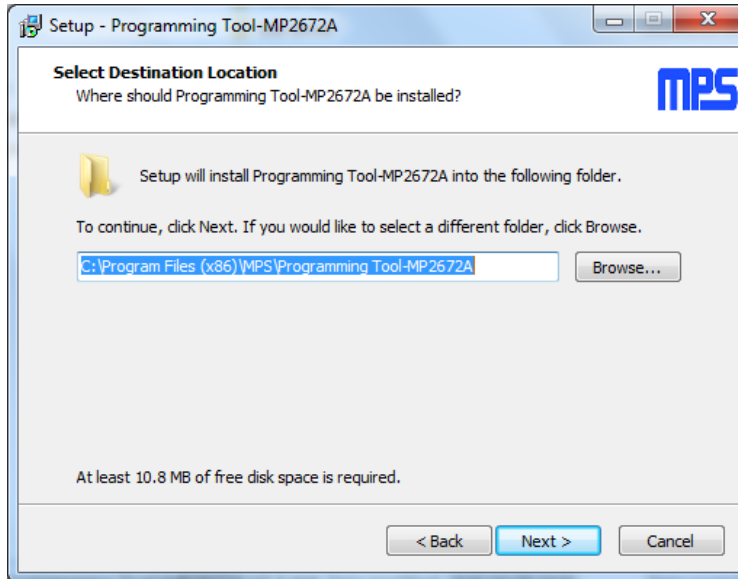

Figure 4: MPS I²C GUI Set-Up Guide

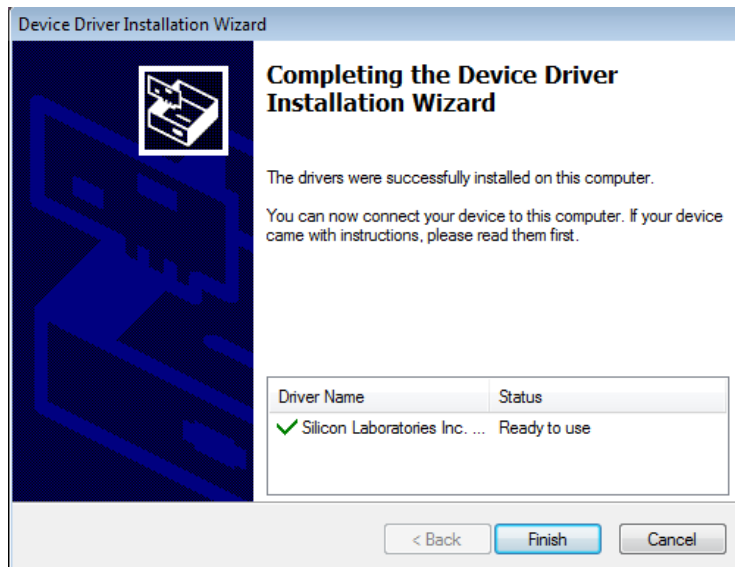

Figure 5: Successful Driver Set-Up

Section 3. Evaluation Kit Test Set-Up

3.1 Hardware Set-Up

The hardware must be properly configured prior to use. Follow the instructions below to set up the system:

1. Locate the proper wires to connect the EVB to the EVKT-USBI2C-02 communication interface.
2. Connect SCL, SDA, and GND (see Figure 6). Refer to the MP2672A datasheet for further clarification.

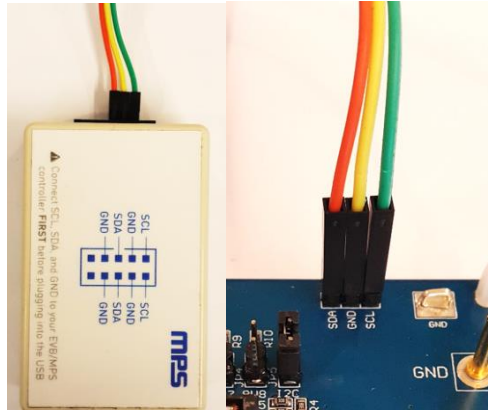

Figure 6: Wire Connection Between EVB and MPS I²C Communication Interface

3.2 Powering Up the EVB

1. Connect the load terminals to:
 - a. Positive (+): SYS
 - b. Negative (-): GND
2. Connect the battery terminals to:
 - a. Positive (+): BATT
 - b. Negative (-): GND

If using a battery emulator, preset the battery voltage between 0V and 9.0V, then turn it off. Connect the battery emulator output to the BATT and GND pins.

3. Preset the power supply output between 4.5V and 6.0V, then turn the power supply off.
4. Connect the power supply terminals to:
 - a. Positive (+): VIN
 - b. Negative (-): GND
5. Ensure that the battery voltage is present (if using a battery emulator, turn the battery emulator on), then turn the power supply on. The IC should automatically enter the start-up sequence.

3.3 Software Set-Up

After connecting the hardware according to the steps above, follow the steps below to use the GUI software:

1. Start the software. It should check the EVB connection automatically.
 - If the connection is successful, both the EVKT-USBI2C-02 and MP2672A demo board statuses will be listed as “Connected” in green (see Figure 7).

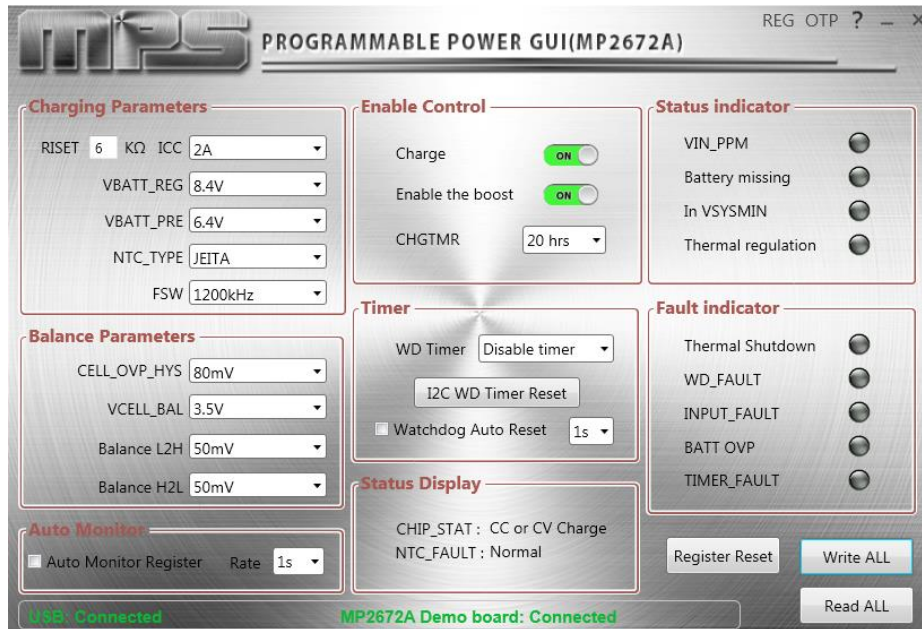

Figure 7: Connected EVKT-USBI2C-02 and MP2672A Demo Board

- If the connection is unsuccessful, they will be listed as “Not Connected” in red. In this case, check the connections between the EVB, communication interface, and PC. Re-plug the USB into computer.
 - If the MP2672A demo board is listed as “Not Connected,” this means that the evaluation board is not connected correctly.
 - If the USB is listed as “Not Connected,” this means that the USB I²C communication interface is not connected correctly
2. Click the “Read All Registers” button to read the I²C register values. The default values should be displayed (see Figure 7).
 3. Find the item to be changed, then select a value from the drop-down menu.
 4. Click the “Write All” button to update the values. The item’s changed information should be downloaded to the IC.

⚠ All changes made via the I²C are restored to default values once the EVB shuts down.

3.4 Device Programming Instructions

The MP2672A is a one-time programmable (OTP) device. Follow the instructions below to create and export customized configurations:

1. Use a computer to open the MPS GUI software. Ensure that the EVB is powered on.
2. Ensure that the EVB and computer are connected.
3. Select “OTP View” in the toolbar (see Figure 8).

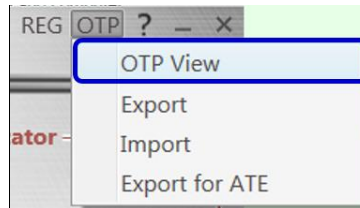

Figure 8: Select OTP

4. Enter a new table (see Figure 9). All of the parameters that can be changed are highlighted in blue in Figure 9.

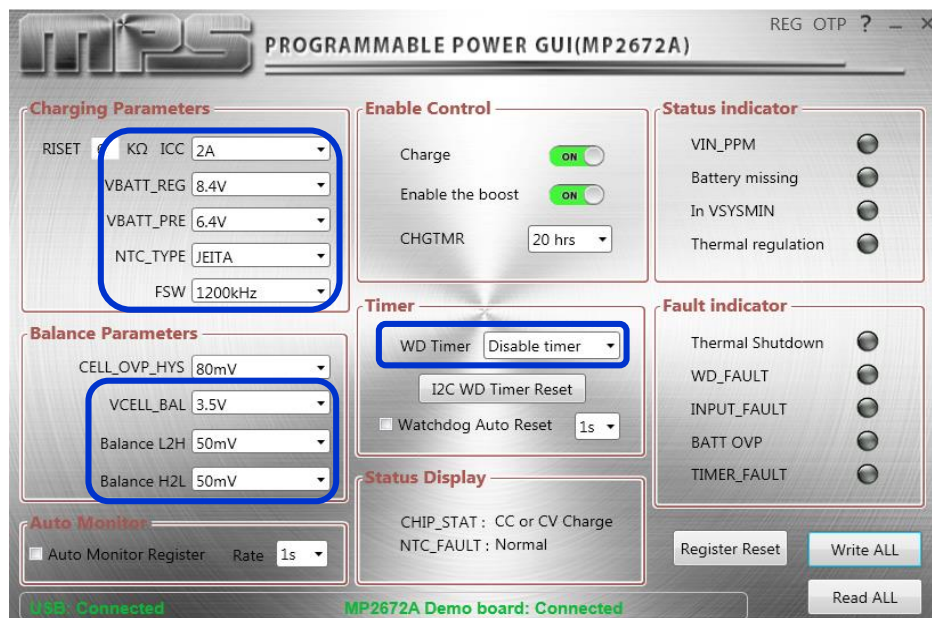

Figure 9: Adjustable Parameters in OTP Mode

5. Select the desired values from the drop-down menus.
6. Ensure that all the parameters are populated before clicking “Export” in the toolbar. The selected configurations will then be exported (see Figure 10).

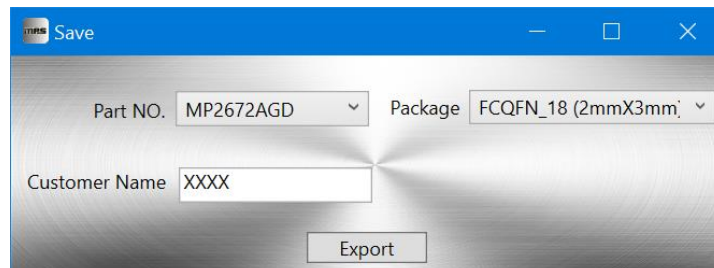

Figure 10: Exporting Configurations

- Find a location for the exported file, then click “Save.” The configurations will save as a .txt file (see Figure 11).

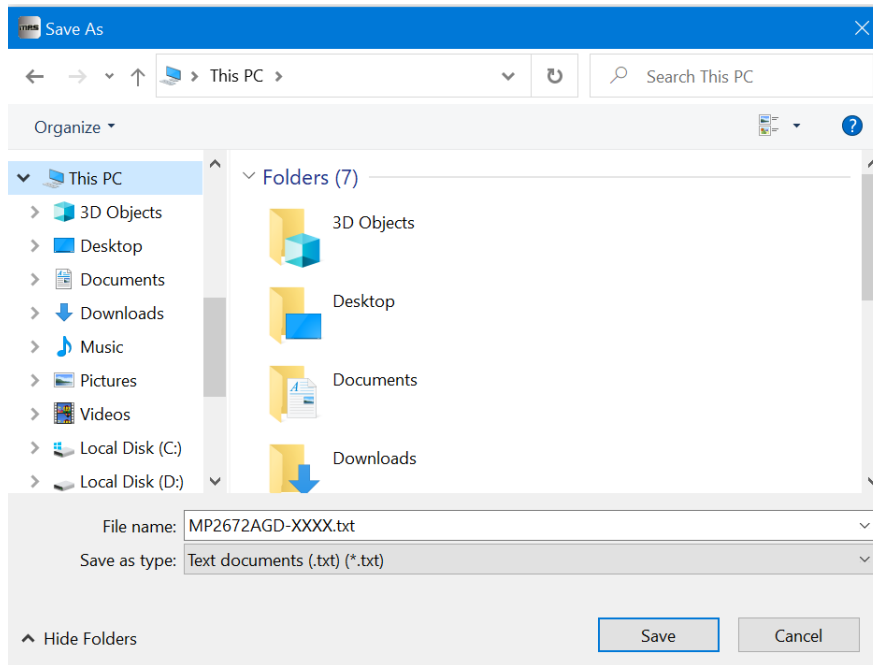

Figure 11: Saving Configurations

- Send this file to an MPS FAE to apply for the customized “xxxx” code.

3.5 Troubleshooting Tips

EVKT-USBI2C-02 Driver Problem

If the USBI2C-02 driver is not properly installed, manual installation is required. Follow the steps below:

Note: Check the driver version. Find “USBXpress Device” in the Device Manager under USB controllers.

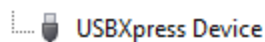

Right-click and view properties. Ensure that the driver version matches the newest version. If the PC is running Windows 10, Windows 10 may automatically install the older USB driver, which is not compatible. The correct driver version should be 4.0.0.0 or newer (see Figure 12).

- Install the correct USBXpress “.exe” file according to the Windows operating system (32-bit or 64-bit).
 - 32-bit: \MPS\Programming Tool-MP2672A\usb driver\USBXpressInstaller_x86.exe
 - 64-bit: \MPS\Programming Tool-MP2672A\usb driver\USBXpressInstaller_x64.exe
- Connect the EVKT-USBI2C-02 communication interface to the PC with the USB cable.

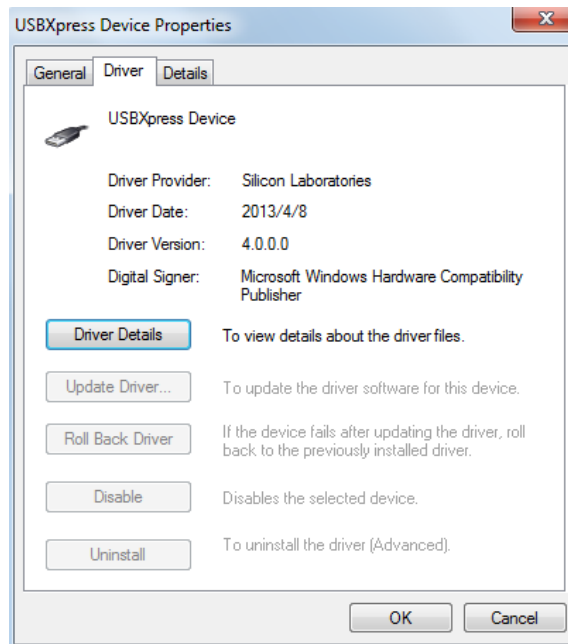

Figure 12: Correct Driver Version Should Be 4.0.0.0 Or Newer

No Supply

The IC's input pin has an under-voltage lockout (UVLO) detection circuit. If the input voltage (V_{IN}) is below the UVLO rising threshold, the charging function is disabled.

No Charging Event

If the IC detects that V_{IN} is below the UVLO falling threshold (the device enters a no-supply state) or over-temperature protection (OTP) is triggered (the device enters a shutdown state), then the IC switches to charge suspend mode, and the system is powered by the battery.

Thermal Recovery

If the die temperature exceeds the thermal protection threshold, MP2672A (boost converter) enters thermal shutdown. Once the die temperature falls back within the save operation range, the IC initiates a new power-on sequence and resumes normal operation.

Section 4. Ordering Information

The components of the evaluation kit can be purchased separately, depending on user needs.

Part Number	Description
EVKT-MP2672A	Complete evaluation kit
Contents of EVKT-MP2672A	
EV2672A-D-00A	MP2672A-xxxx evaluation board
EVKT-USBI2C-02 bag	Includes one USB to I ² C communication interface, one USB cable, and one ribbon cable
Online resources	Include datasheet, user guide, product brief, and GUI

Order directly from MonolithicPower.com or our distributors.

Revision History

Revision #	Revision Date	Description	Pages Updated
1.0	11/6/2020	Initial Release	-